

# 1SS355

## Silicon Epitaxial Planar Switching Diode

### Features

- Small plastic package suitable for surface mounted design
- High reliability with high surge current handling capability

### Applications

- High speed switching

#### PINNING

PIN	DESCRIPTION
1	Cathode
2	Anode

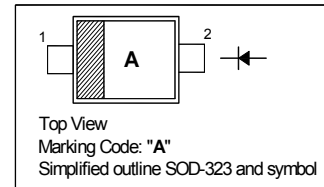

### Absolute Maximum Ratings ( $T_a = 25\text{ }^\circ\text{C}$ )

Parameter	Symbol	Value	Unit
Peak Reverse Voltage	$V_{RM}$	90	V
Reverse Voltage	$V_R$	80	V
Average Rectified Forward Current	$I_{F(AV)}$	100	mA
Peak Forward Current	$I_{FM}$	225	mA
Surge Forward Current (1 s)	$I_{FSM}$	500	mA
Junction Temperature	$T_j$	150	$^\circ\text{C}$
Storage Temperature Range	$T_{stg}$	- 55 to + 150	$^\circ\text{C}$

### Electrical Characteristics ( $T_a = 25\text{ }^\circ\text{C}$ )

Parameter	Symbol	Max.	Unit
Forward Voltage at $I_F = 100\text{ mA}$	$V_F$	1.2	V
Reverse Current at $V_R = 80\text{ V}$	$I_R$	0.1	$\mu\text{A}$
Capacitance between Terminals at $V_R = 0.5\text{ V}$ , $f = 1\text{ MHz}$	$C_T$	3	pF
Reverse Recovery Time at $V_R = 6\text{ V}$ , $I_F = 10\text{ mA}$ , $R_L = 100\text{ }\Omega$	$t_{rr}$	4	ns

**TOP DYNAMIC**

**Forward Characteristics**

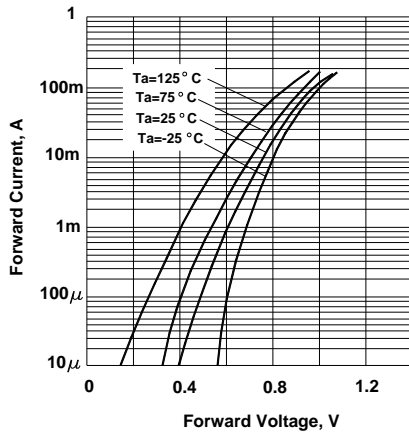

**Reverse Characteristics**

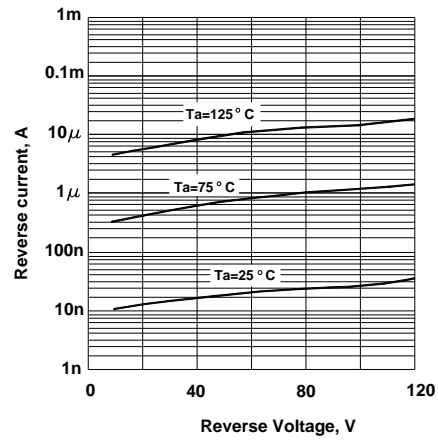

**Capacitance between terminals characteristics**

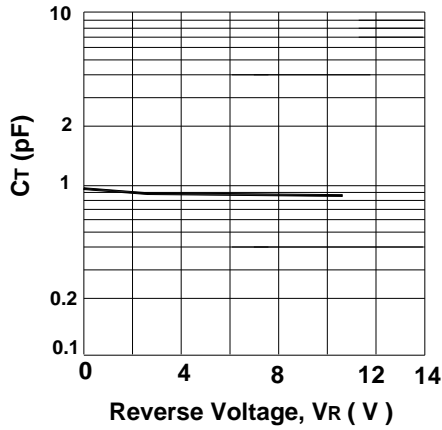

**Reverse Recovery Time Characteristics**

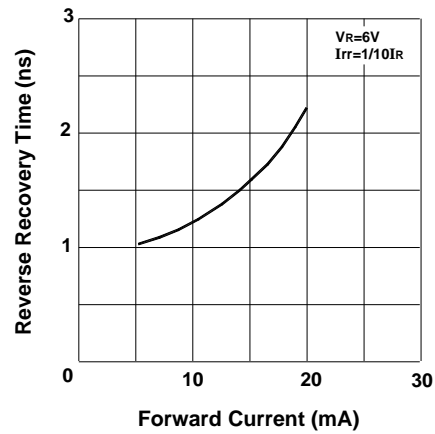

**Surge Current Characteristics**

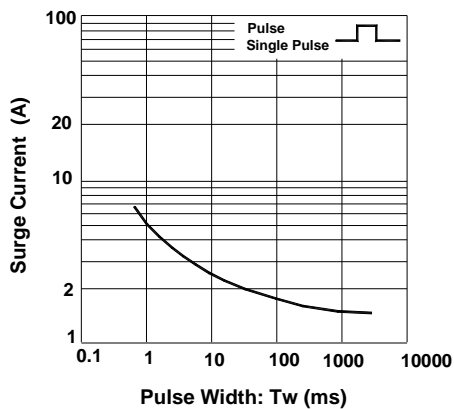

**Reverse Recovery Time Measurement Circuit**

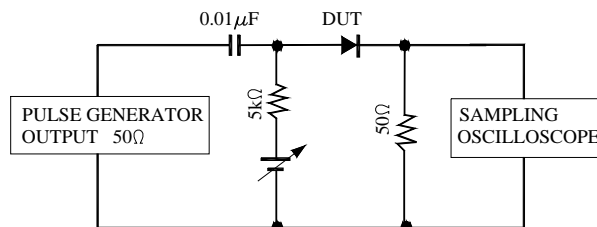

PACKAGE OUTLINE

Plastic surface mounted package; 2 leads

SOD-323

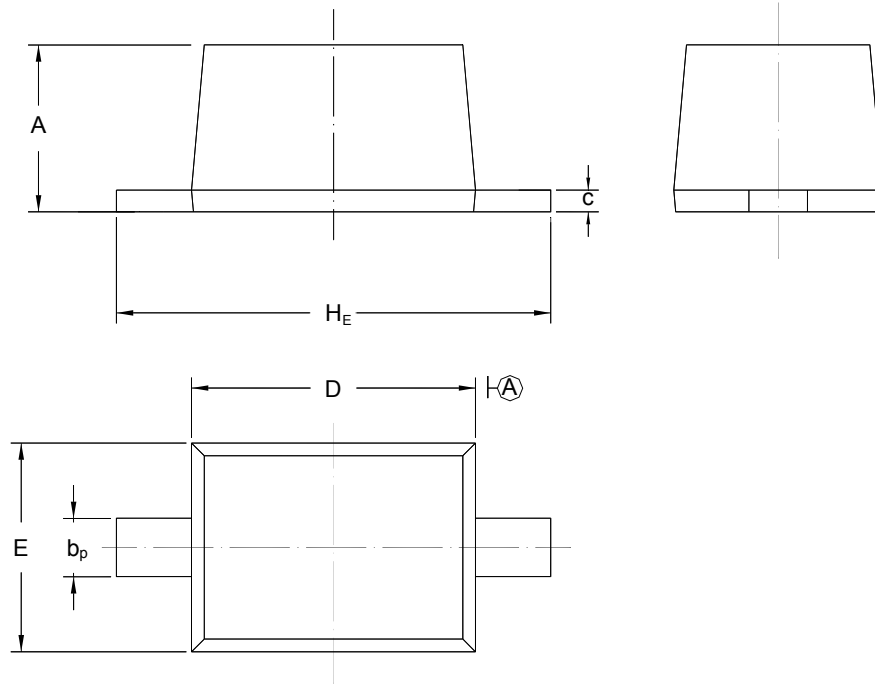

UNIT	A	b <sub>p</sub>	C	D	E	H <sub>E</sub>
mm	1.10 0.80	0.40 0.25	0.15 0.10	1.80 1.60	1.35 1.15	2.80 2.30