



MICROCHIP

**MCP2210
Breakout Module
User's Guide**

Note the following details of the code protection feature on Microchip devices:

- Microchip products meet the specification contained in their particular Microchip Data Sheet.
- Microchip believes that its family of products is one of the most secure families of its kind on the market today, when used in the intended manner and under normal conditions.
- There are dishonest and possibly illegal methods used to breach the code protection feature. All of these methods, to our knowledge, require using the Microchip products in a manner outside the operating specifications contained in Microchip's Data Sheets. Most likely, the person doing so is engaged in theft of intellectual property.
- Microchip is willing to work with the customer who is concerned about the integrity of their code.
- Neither Microchip nor any other semiconductor manufacturer can guarantee the security of their code. Code protection does not mean that we are guaranteeing the product as "unbreakable."

Code protection is constantly evolving. We at Microchip are committed to continuously improving the code protection features of our products. Attempts to break Microchip's code protection feature may be a violation of the Digital Millennium Copyright Act. If such acts allow unauthorized access to your software or other copyrighted work, you may have a right to sue for relief under that Act.

Information contained in this publication regarding device applications and the like is provided only for your convenience and may be superseded by updates. It is your responsibility to ensure that your application meets with your specifications. MICROCHIP MAKES NO REPRESENTATIONS OR WARRANTIES OF ANY KIND WHETHER EXPRESS OR IMPLIED, WRITTEN OR ORAL, STATUTORY OR OTHERWISE, RELATED TO THE INFORMATION, INCLUDING BUT NOT LIMITED TO ITS CONDITION, QUALITY, PERFORMANCE, MERCHANTABILITY OR FITNESS FOR PURPOSE. Microchip disclaims all liability arising from this information and its use. Use of Microchip devices in life support and/or safety applications is entirely at the buyer's risk, and the buyer agrees to defend, indemnify and hold harmless Microchip from any and all damages, claims, suits, or expenses resulting from such use. No licenses are conveyed, implicitly or otherwise, under any Microchip intellectual property rights.

Trademarks

The Microchip name and logo, the Microchip logo, dsPIC, KEELOQ, KEELOQ logo, MPLAB, PIC, PICmicro, PICSTART, PIC³² logo, rfPIC and UNI/O are registered trademarks of Microchip Technology Incorporated in the U.S.A. and other countries.

FilterLab, Hampshire, HI-TECH C, Linear Active Thermistor, MXDEV, MXLAB, SEEVAL and The Embedded Control Solutions Company are registered trademarks of Microchip Technology Incorporated in the U.S.A.

Analog-for-the-Digital Age, Application Maestro, chipKIT, chipKIT logo, CodeGuard, dsPICDEM, dsPICDEM.net, dsPICworks, dsSPEAK, ECAN, ECONOMONITOR, FanSense, HI-TIDE, In-Circuit Serial Programming, ICSP, Mindi, MiWi, MPASM, MPLAB Certified logo, MPLIB, MPLINK, mTouch, Omniscient Code Generation, PICC, PICC-18, PICDEM, PICDEM.net, PICkit, PICtail, REAL ICE, rfLAB, Select Mode, Total Endurance, TSHARC, UniWinDriver, WiperLock and ZENA are trademarks of Microchip Technology Incorporated in the U.S.A. and other countries.

SQTP is a service mark of Microchip Technology Incorporated in the U.S.A.

All other trademarks mentioned herein are property of their respective companies.

© 2012, Microchip Technology Incorporated, Printed in the U.S.A., All Rights Reserved.

 Printed on recycled paper.

ISBN: 978-1-62076-117-5

**QUALITY MANAGEMENT SYSTEM
CERTIFIED BY DNV
= ISO/TS 16949 =**

Microchip received ISO/TS-16949:2009 certification for its worldwide headquarters, design and wafer fabrication facilities in Chandler and Tempe, Arizona; Gresham, Oregon and design centers in California and India. The Company's quality system processes and procedures are for its PIC[®] MCUs and dsPIC[®] DSCs, KEELOQ[®] code hopping devices, Serial EEPROMs, microperipherals, nonvolatile memory and analog products. In addition, Microchip's quality system for the design and manufacture of development systems is ISO 9001:2000 certified.

Table of Contents

Preface	5
Introduction.....	5
Document Layout	5
Conventions Used in this Guide	6
Recommended Reading.....	7
The Microchip Web Site	7
Customer Support	7
Document Revision History	7
 Chapter 1. Product Overview	
1.1 Introduction	9
1.2 MCP2210 Breakout Module General Description	9
1.3 What the MCP2210 Breakout Module Kit Includes	9
 Chapter 2. Installation and Operation	
2.1 Introduction	11
2.2 Board Setup	11
2.3 Board Operation	12
2.4 MCP2210 Typical Usage Scenarios	14
 Appendix A. Schematic and Layouts	
A.1 Introduction	17
A.2 Board – Schematic	18
A.3 Board – Top Silk and Pads	19
A.4 Board – Top Silk, Pads and Copper	20
A.5 Board – Top Pads and Copper	21
A.6 Board – Bottom Silk and Pads	22
A.7 Board – Bottom Silk, Pads and Copper	23
A.8 Board – Bottom Pads and Copper	24
 Appendix B. Bill of Materials	
Worldwide Sales and Service	26

MCP2210 Breakout Module User's Guide

Preface

NOTICE TO CUSTOMERS

All documentation becomes dated, and this manual is no exception. Microchip tools and documentation are constantly evolving to meet customer needs, so some actual dialogs and/or tool descriptions may differ from those in this document. Please refer to our web site (www.microchip.com) to obtain the latest documentation available.

Documents are identified with a “DS” number. This number is located on the bottom of each page, in front of the page number. The numbering convention for the DS number is “DSXXXXA”, where “XXXX” is the document number and “A” is the revision level of the document.

For the most up-to-date information on development tools, see the MPLAB® IDE online help. Select the Help menu, and then Topics to open a list of available online help files.

INTRODUCTION

This chapter contains general information that will be useful to know before using the MCP2210 Breakout Module. Items discussed in this chapter include:

- Document Layout
- Conventions Used in this Guide
- Recommended Reading
- The Microchip Web Site
- Customer Support
- Document Revision History

DOCUMENT LAYOUT

This document describes how to use the MCP2210 Breakout Module board. The manual layout is as follows:

- **Chapter 1. “Product Overview”** – Important information about the MCP2210 Breakout Module
- **Chapter 2. “Installation and Operation”** – Covers the initial set-up of this board, required tools, board setup and Graphical User Interface (GUI)
- **Appendix A. “Schematic and Layouts”** – Shows the schematic and board layouts for the MCP2210 Breakout Module User’s Guide
- **Appendix B. “Bill of Materials”** – Lists the parts used to populate the MCP2210 Breakout Module

MCP2210 Breakout Module User's Guide

CONVENTIONS USED IN THIS GUIDE

This manual uses the following documentation conventions:

DOCUMENTATION CONVENTIONS

Description	Represents	Examples
Arial font:		
Italic characters	Referenced books	<i>MPLAB[®] IDE User's Guide</i>
	Emphasized text	...is the <i>only</i> compiler...
Initial caps	A window	the Output window
	A dialog	the Settings dialog
	A menu selection	select Enable Programmer
Quotes	A field name in a window or dialog	"Save project before build"
Underlined, italic text with right angle bracket	A menu path	<u><i>File>Save</i></u>
Bold characters	A dialog button	Click OK
	A tab	Click the Power tab
N'Rnnnn	A number in verilog format, where N is the total number of digits, R is the radix and n is a digit.	4'b0010, 2'hF1
Text in angle brackets < >	A key on the keyboard	Press <Enter>, <F1>
Courier New font:		
Plain Courier New	Sample source code	#define START
	Filenames	autoexec.bat
	File paths	c:\mcc18\h
	Keywords	_asm, _endasm, static
	Command-line options	-Opa+, -Opa-
	Bit values	0, 1
	Constants	0xFF, 'A'
Italic Courier New	A variable argument	<i>file.o</i> , where <i>file</i> can be any valid filename
Square brackets []	Optional arguments	mcc18 [options] <i>file</i> [options]
Curly brackets and pipe character: { }	Choice of mutually exclusive arguments; an OR selection	errorlevel {0 1}
Ellipses...	Replaces repeated text	var_name [, var_name...]
	Represents code supplied by user	void main (void) { ... }

RECOMMENDED READING

This user's guide describes how to use MCP2210 Breakout Module. Other useful documents are listed below. The following Microchip document is available and recommended as a supplemental reference resource.

- **MCP2210 Data Sheet - “USB-to-SPI Protocol Converter with GPIO (Master Mode)” (DS22288)**

THE MICROCHIP WEB SITE

Microchip provides online support via our web site at www.microchip.com. This web site is used as a means to make files and information easily available to customers. Accessible by using your favorite Internet browser, the web site contains the following information:

- **Product Support** – Data sheets and errata, application notes and sample programs, design resources, user's guides and hardware support documents, latest software releases and archived software
- **General Technical Support** – Frequently Asked Questions (FAQs), technical support requests, online discussion groups, Microchip consultant program member listing
- **Business of Microchip** – Product selector and ordering guides, latest Microchip press releases, listing of seminars and events, listings of Microchip sales offices, distributors and factory representatives

CUSTOMER SUPPORT

Users of Microchip products can receive assistance through several channels:

- Distributor or Representative
- Local Sales Office
- Field Application Engineer (FAE)
- Technical Support

Customers should contact their distributor, representative or field application engineer (FAE) for support. Local sales offices are also available to help customers. A listing of sales offices and locations is included in the back of this document.

Technical support is available through the web site at: <http://www.microchip.com/support>.

DOCUMENT REVISION HISTORY

Revision A (March 2012)

- Initial Release of this Document.

MCP2210 Breakout Module User's Guide

NOTES:

Chapter 1. Product Overview

1.1 INTRODUCTION

This chapter provides an overview of the MCP2210 Breakout Module and covers the following topics:

- MCP2210 Breakout Module General Description
- What the MCP2210 Breakout Module Kit Includes

1.2 MCP2210 BREAKOUT MODULE GENERAL DESCRIPTION

The MCP2210 Breakout Module is a development and evaluation platform for the MCP2210 device. The module is comprised of a single DIP form-factor board.

The MCP2210 Breakout Module has the following features:

- SPI bus signals (MOSI, MISO, SCK)
- Nine GP lines, configurable for GPIO, Chip Select or dedicated function operation
- Provides a user selectable (by using a jumper) power supply of 3.3V or 5V (up to 500 mA)
- DIP form-factor (0.6 inches overall row spacing between pins)
- PICkit™ Serial Analyzer header – used for SPI communication only

A Windows®-based PC software was created to help with the evaluation/demonstration of the MCP2210 device as a USB-to-SPI (Master) device. It allows I/O control and custom device configuration. The software is downloadable from the board web page on www.microchip.com.

A DLL package is included to allow development of custom PC applications using the MCP2210. The DLL package is also available for download on the board web page.

1.3 WHAT THE MCP2210 BREAKOUT MODULE KIT INCLUDES

The MCP2210 Breakout Module Kit includes:

- MCP2210 Breakout Module (ADM00419)
- Mini-USB cable
- Important Information Sheet

MCP2210 Breakout Module User's Guide

NOTES:

Chapter 2. Installation and Operation

2.1 INTRODUCTION

The MCP2210 Breakout Module is designed to demonstrate the device as a USB-to-SPI (Master) bridge solution.

The package is comprised of a single board and has the following features:

- Small plug-in board with DIP form factor (600 millimeters overall row spacing between pins)
- Mini-USB connector
- Access to SPI bus and all GP signals through USB port
- PICKIT™ Serial Analyzer compatible header
- 3.3 or 5V jumper selectable V_{DD} ; the breakout board can be used to supply up to 500 mA to the rest of the system. The board already provides a signal trace between the V_{DD} and the 3.3V rail. For systems requiring 5V V_{DD} power supply, V_{DD} header must be mounted on the board. A jumper will close the middle pin and the 5V pin.

2.2 BOARD SETUP

Follow these steps to set up the MCP2210 Breakout Module:

1. Download the support material (PC applications and DLL libraries) that can be found on the board's page, on the Microchip web site.
2. Attach the MCP2210 Breakout Module to a board that has one or more SPI slave devices attached to a bus (SPI).
3. Plug the MCP2210 Breakout Module in to a PC.
4. The computer operating system will automatically install the driver for this board. When the installation is complete, the board is ready for operation.
5. Install the downloaded PC software.
6. Start the SPI Terminal utility.

MCP2210 Breakout Module User's Guide

2.3 BOARD OPERATION

The MCP2210 will be detected by a Windows PC host as an HID device. The accompanying software can be used to exercise the MCP2210 Breakout Module's features and also provides a reference point for users that want to design their own applications based on the MCP2210 device.

2.3.1 MCP2210 Breakout Board Operation

The MCP2210 Breakout Module can be used as a stand-alone USB-to-SPI (Master) bridge module. The breakout board provides all the signals required to assist the user in building their boards with the MCP2210.

The board has the following features:

- SPI bus signals (MOSI, MISO, SCK)
- Nine GP signals that can be configured for:
 - GPIO functionality (digital input or output pins)
 - Chip Select functionality (working with the SPI bus signals)
 - Dedicated function pins
- Jumper selectable power supply: 3.3 or 5V (up to 500 mA)
- PICKIT™ Serial Analyzer header using GP4 pin as Chip Select signal

<p>Note: This function is available only on SPI operations, it does not work on I²C or UART signals.</p>
--

- DIP form-factor (0.6 inches overall row spacing between pins)

By using the provided software and libraries, the user can create personalized PC applications, using the breakout board as a USB-to-SPI (Master) bridge adapter.

2.3.2 MCP2210 Utility

The MCP2210 Utility software was created for custom device setting requirements. A few of the settings that this utility can alter include VID, PID, power requirements, and string descriptors. A download link for this software can be found on the board web page. For instructions on the use of this software, refer to the software's supporting documentation included within the application install package.

2.3.3 SPI Terminal Utility

The SPI Terminal Utility is a tool that allows low-level data exchange at the SPI bus level. This application is useful for low-level communication and troubleshooting between the MCP2210 and various SPI slave modules.

The utility window has different sections for GP designation, SPI transfer parameters and user data areas.

FIGURE 2-1: SPI TERMINAL UTILITY WINDOW

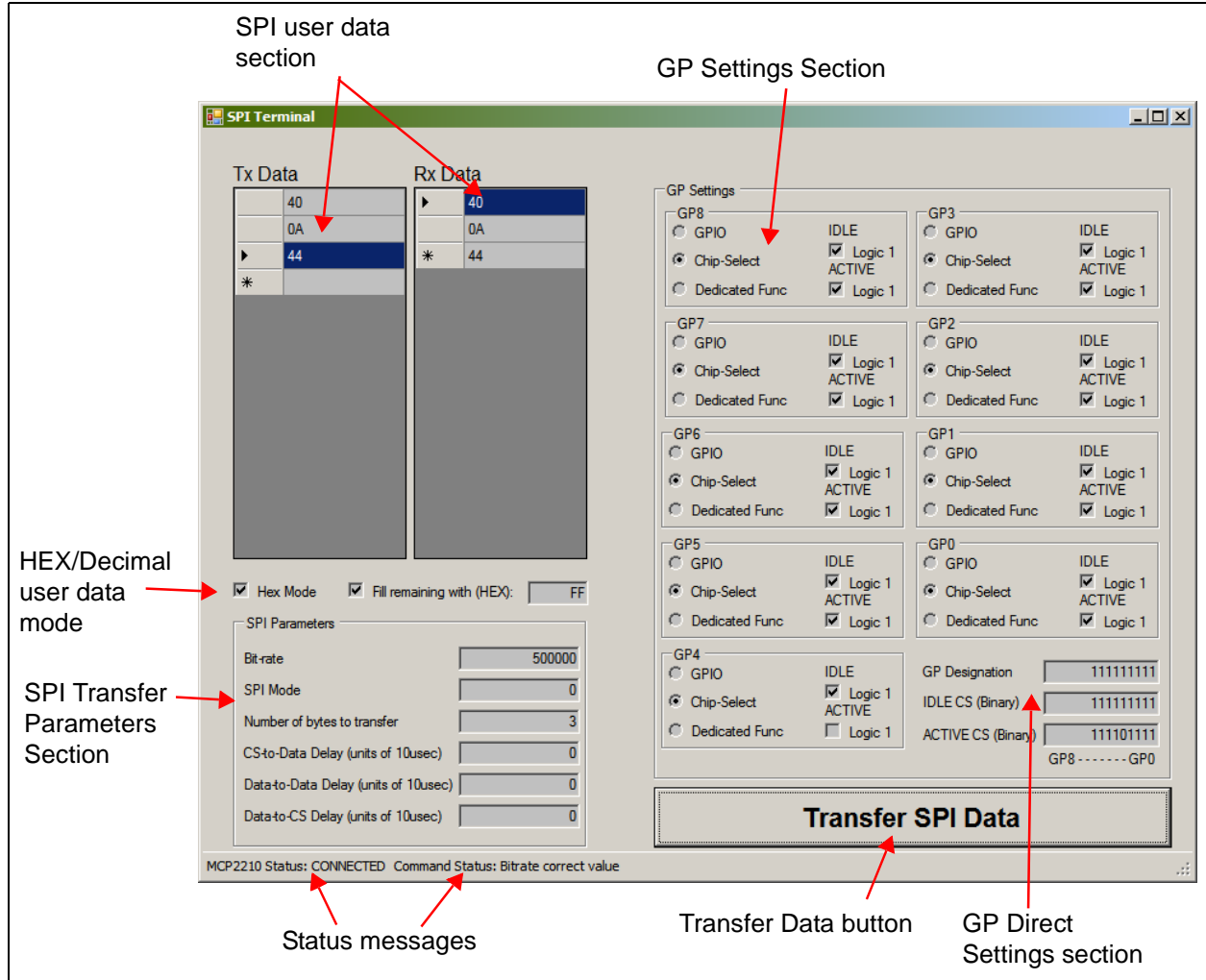

After the application is started, the state of the connection with the MCP2210 is shown in the Status Messages section (lower left corner of the screen).

The user can establish the GP configuration. The GPs can be used as chip select pins. Each GP Active and Idle value can be established by selecting the appropriate check boxes, or by directly supplying the correct value in the GP Direct Settings section. The same behavior applies to the GP designation (the GP designation can be established by clicking the appropriate radio button, or by directly supplying the GP designation value in the GP Settings Direct Values section).

The SPI settings pertaining to the needed SPI transfer can be established in the SPI Parameters section.

The data to be sent goes in the **Tx Data** field. To send the data to the SPI slave device, click the **SPI Transfer Data** button on the lower-right side of the screen. The data received from the SPI slave device is displayed in the **Rx Data** field.

The user data can be supplied in either HEX or Decimal mode. This can be accomplished by selecting the HEX mode check box. The data in the **Tx** and **Rx Data** fields will be displayed in HEX or Decimal.

MCP2210 Breakout Module User's Guide

A wider range of tests is available when using this board and the utility software with the MCP2210 Evaluation Kit (ADM00421). This kit allows communication with several SPI slave devices (I/O expander, EEPROM, ADC and temperature sensor). For more details on examples using the SPI Terminal Utility software, see *MCP2210 Evaluation Kit User's Guide* (DS52057).

2.4 MCP2210 TYPICAL USAGE SCENARIOS

MCP2210 can be used in systems where an SPI bus is available. The MCP2210 can be either the single master on the bus, or one of the masters sharing the bus, if a proper master access arbitration scheme is in place.

A typical usage scenario is shown in Figure 2-2, where MCP2210 is the only master on the SPI bus. This links the SPI slave chips in the system, while a few GPs (configured for Chip Select function) can be used as Chip Select lines.

If SPI slave interrupt monitoring is required, the GP6 needs to be configured for its dedicated function, in order to monitor the interrupts coming from the SPI slave chips.

The PC application will take care of all the details necessary for data transfer between the MCP2210 and the SPI slave chips.

FIGURE 2-2: MCP2210 TYPICAL USAGE DIAGRAM

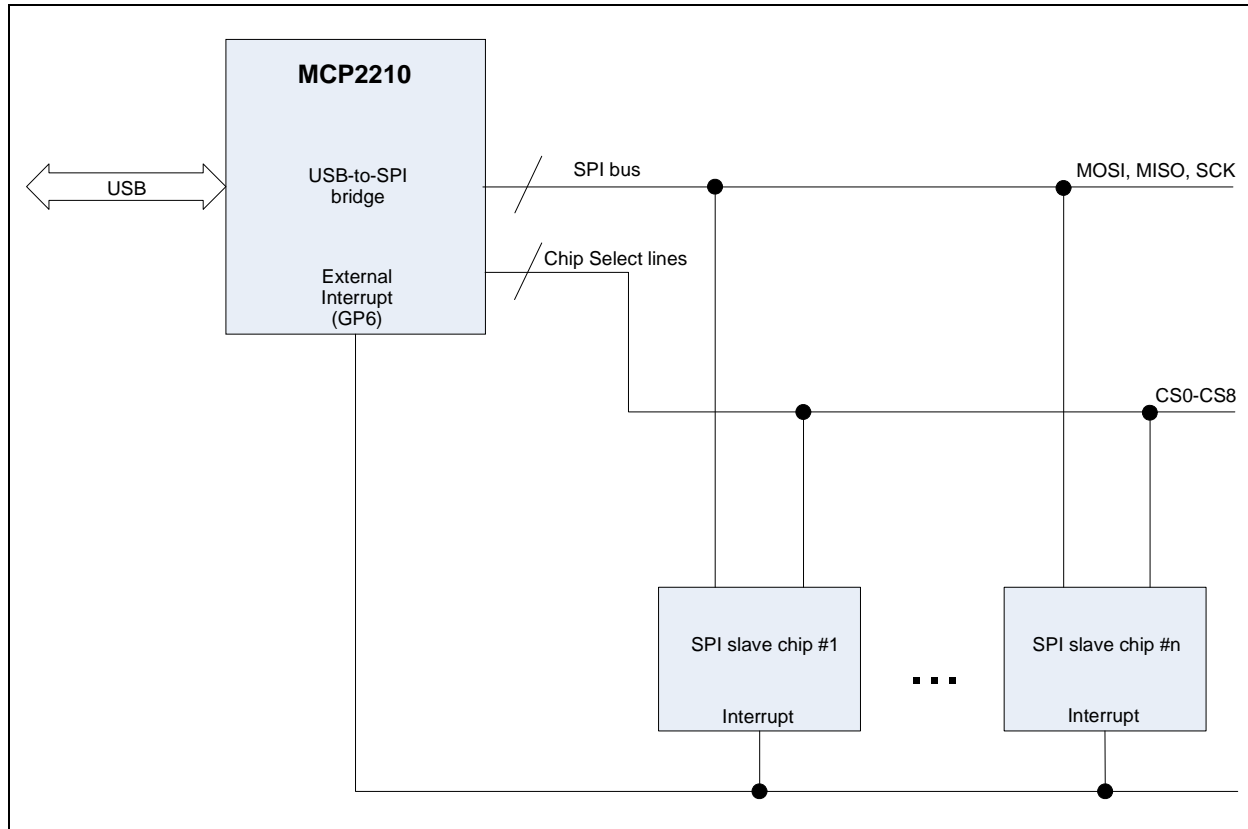

When a system requires more than one SPI master that share the same bus, an arbitration scheme needs to be developed, in order to prevent the multiple SPI masters from accessing the bus at the same time.

MCP2210 has support for an arbitration mechanism which uses GP7 and GP8 (configured for dedicated pin functionality) for this purpose.

Installation and Operation

When GP8 is configured for its dedicated functionality, the pin can be used as a bus release request for MCP2210 coming from another master. GP7 (configured for its dedicated functionality) is used as an SPI bus release acknowledge signal towards the requesting master. When an external SPI master requests the MCP2210 to release the bus, the device completes the current SPI transfer (or it can be cancelled by the PC application sending the proper USB command), then releases the bus and signals the event on the acknowledge pin (GP7). The second master now has ownership of the bus, and can keep it, as long as the SPI bus request pin (GP8) is kept asserted.

By using the dedicated functionality of the GP7 and GP8, the MCP2210 can be used in a multiple SPI master system.

FIGURE 2-3: MCP2210 TYPICAL USAGE DIAGRAM

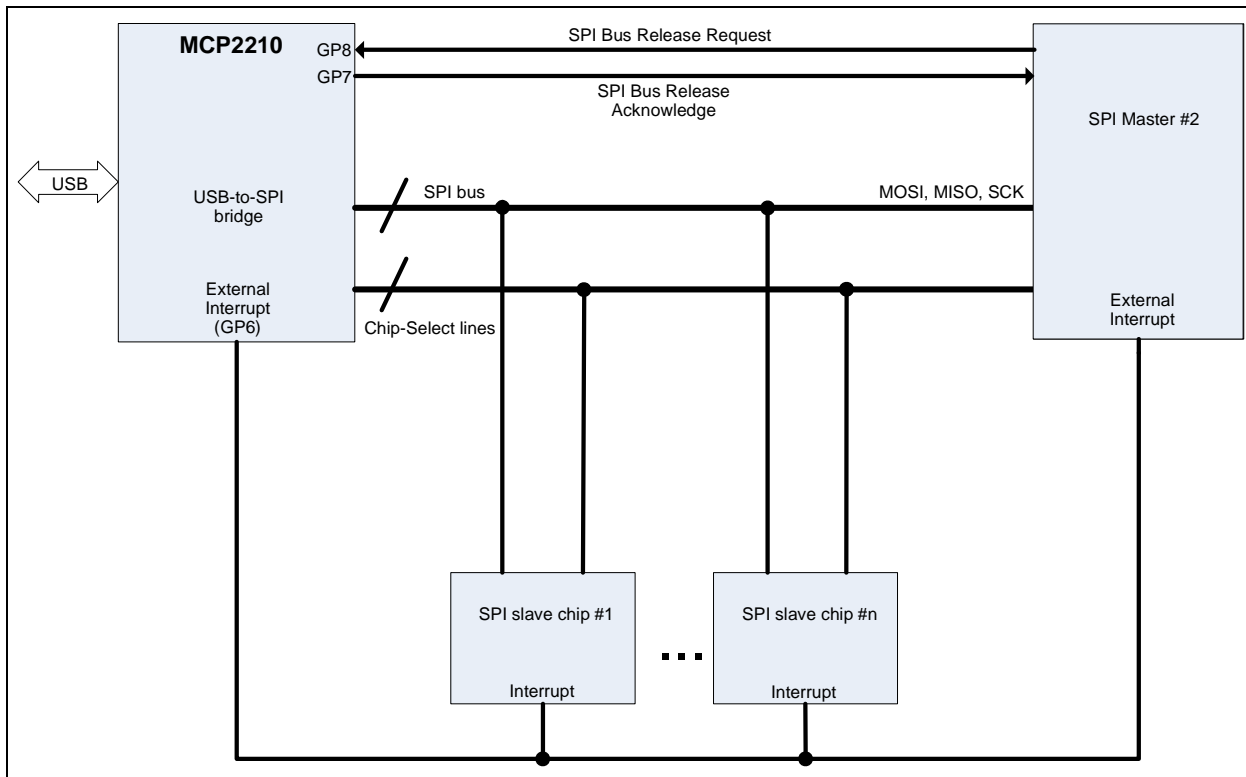

MCP2210 Breakout Module User's Guide



MCP2210 BREAKOUT MODULE USER'S GUIDE

Appendix A. Schematic and Layouts

A.1 INTRODUCTION

This appendix contains the following schematics and layouts for the MCP2210 Breakout Module:

- Board – Schematic
- Board – Top Silk and Pads
- Board – Top Silk, Pads and Copper
- Board – Top Pads and Copper
- Board – Bottom Silk and Pads
- Board – Bottom Silk, Pads and Copper
- Board – Bottom Pads and Copper

MCP2210 Breakout Module User's Guide

A.2 BOARD – SCHEMATIC

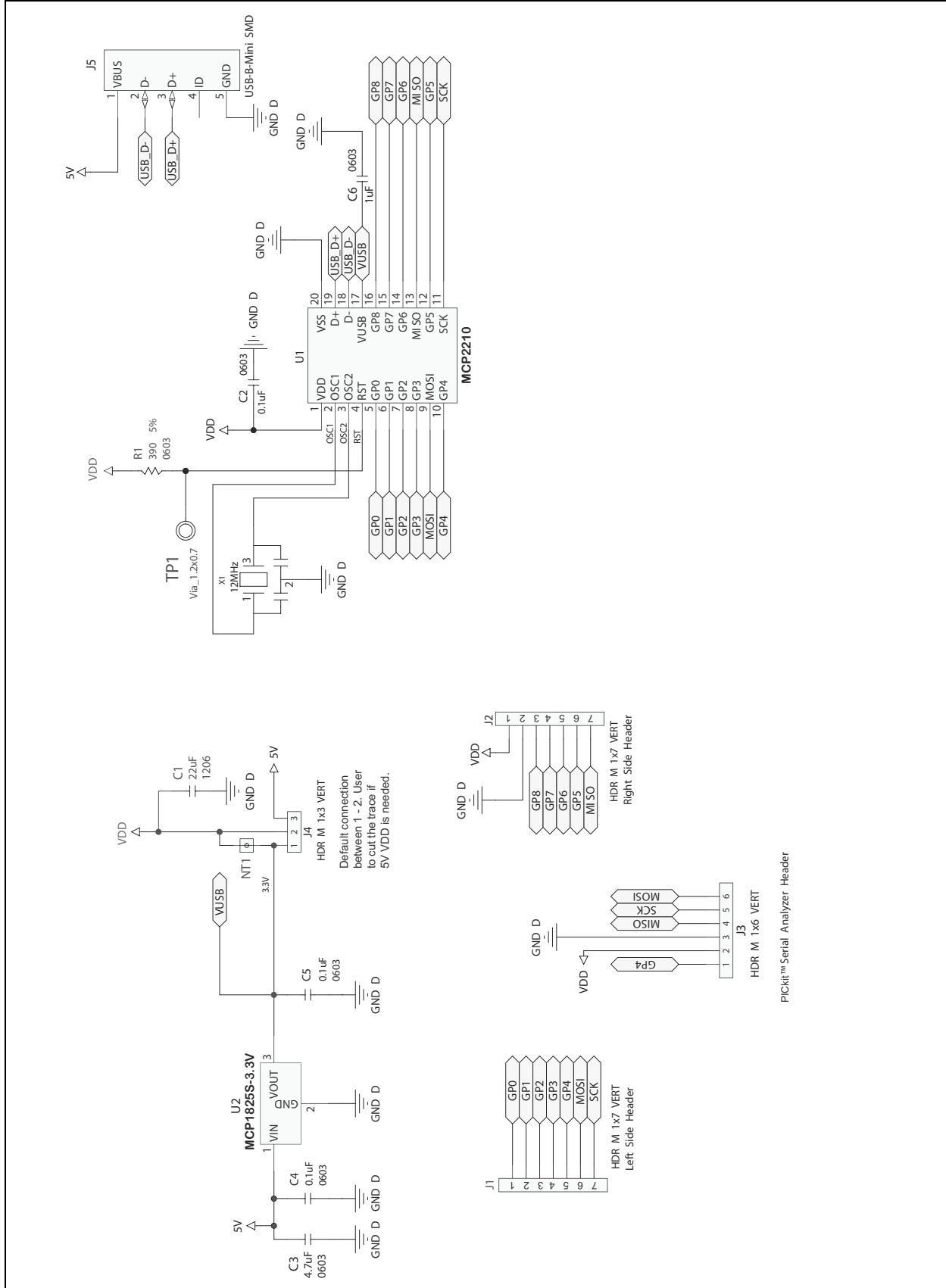

PiCkit™ Serial Analyzer Header

A.3 BOARD – TOP SILK AND PADS

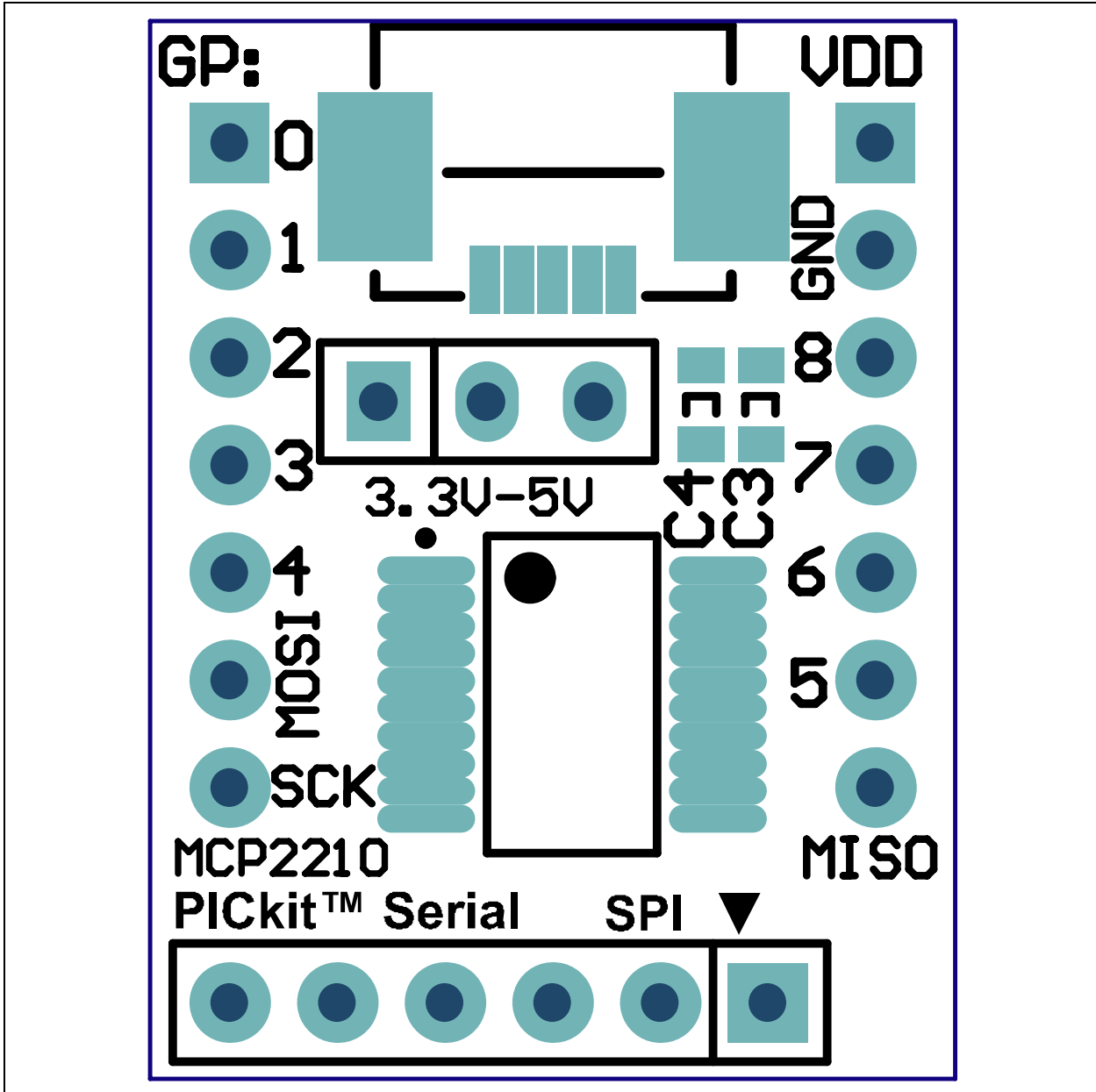

MCP2210 Breakout Module User's Guide

A.4 BOARD – TOP SILK, PADS AND COPPER

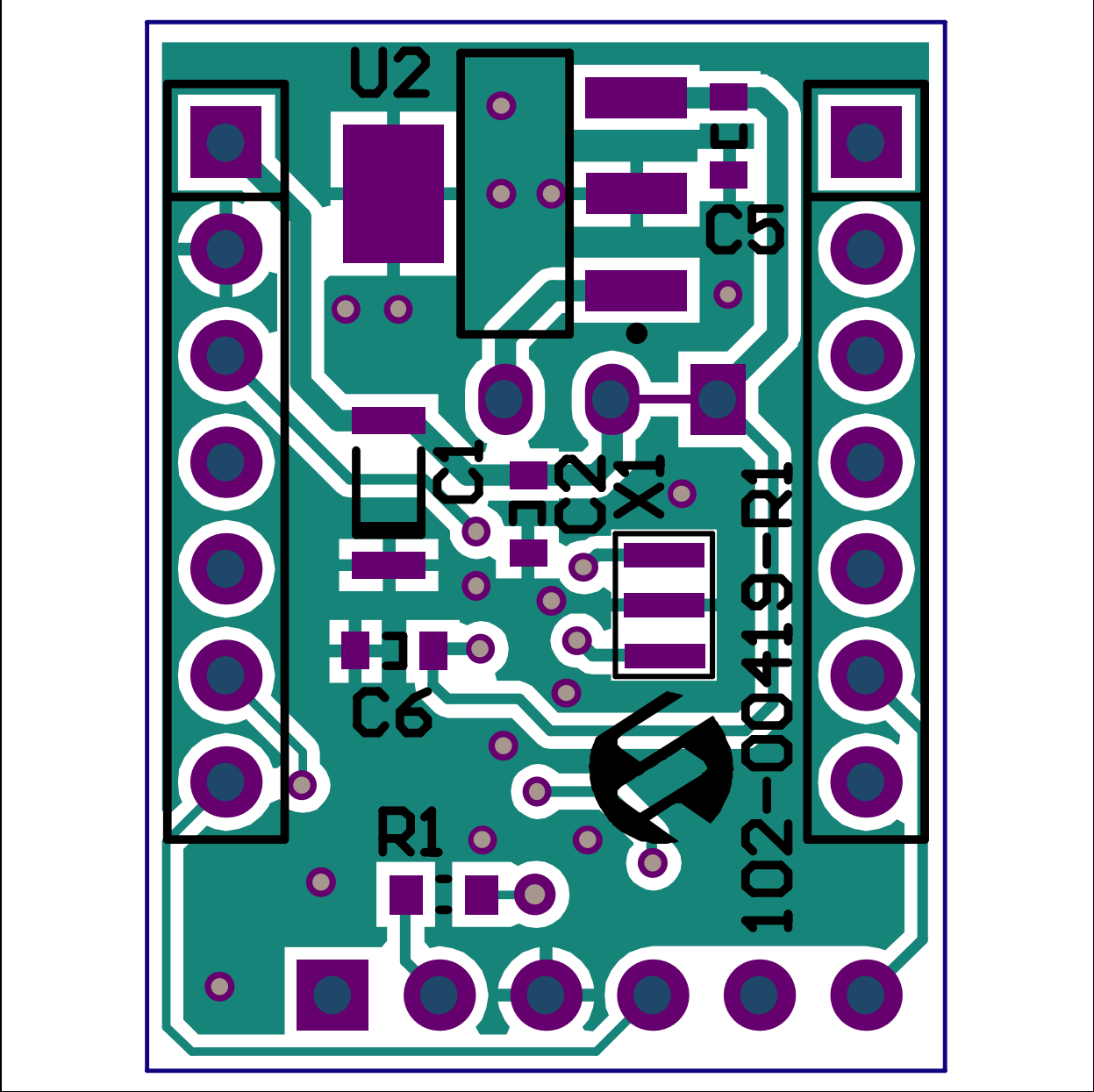

A.5 BOARD – TOP PADS AND COPPER

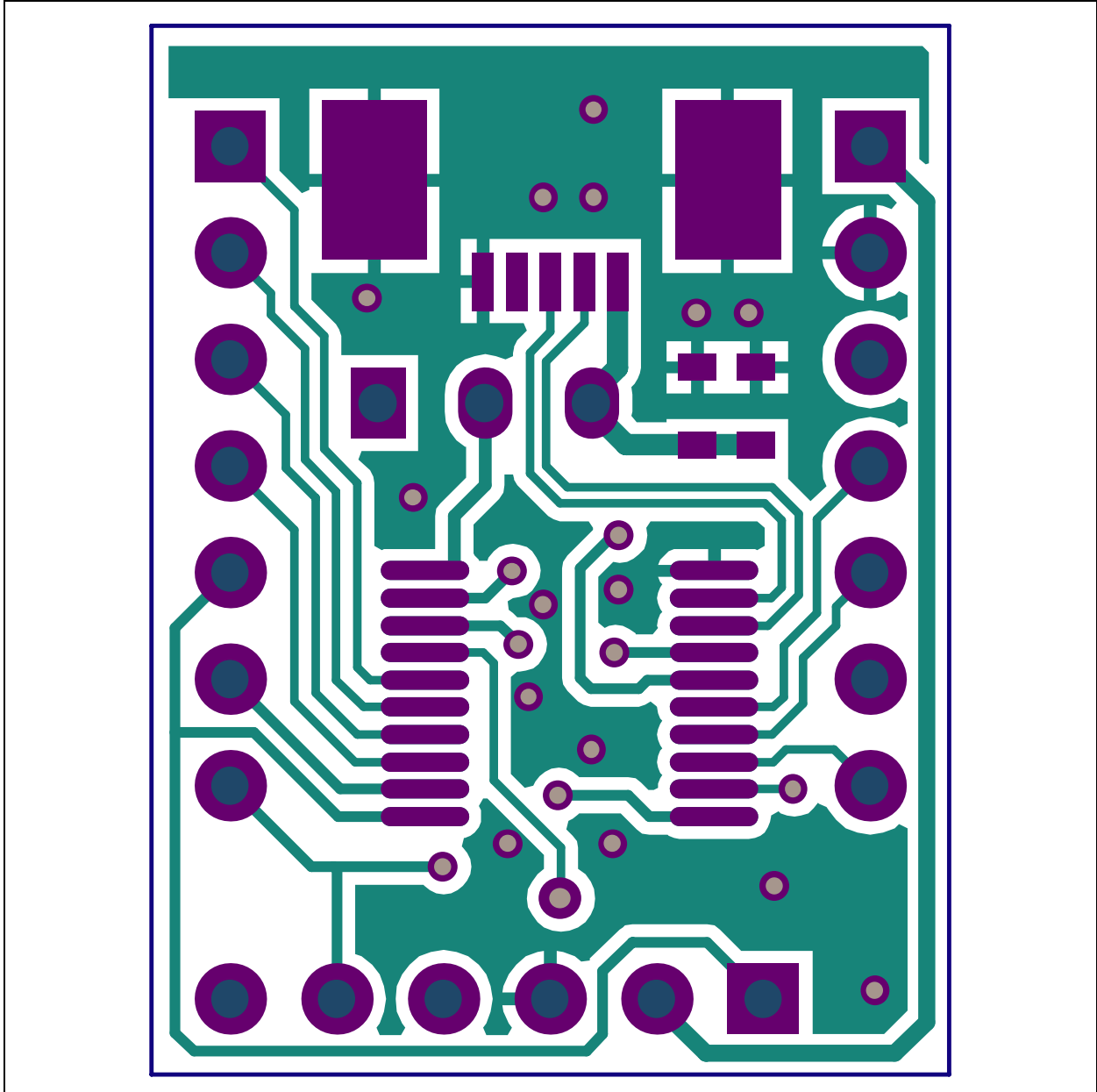

MCP2210 Breakout Module User's Guide

A.6 BOARD – BOTTOM SILK AND PADS

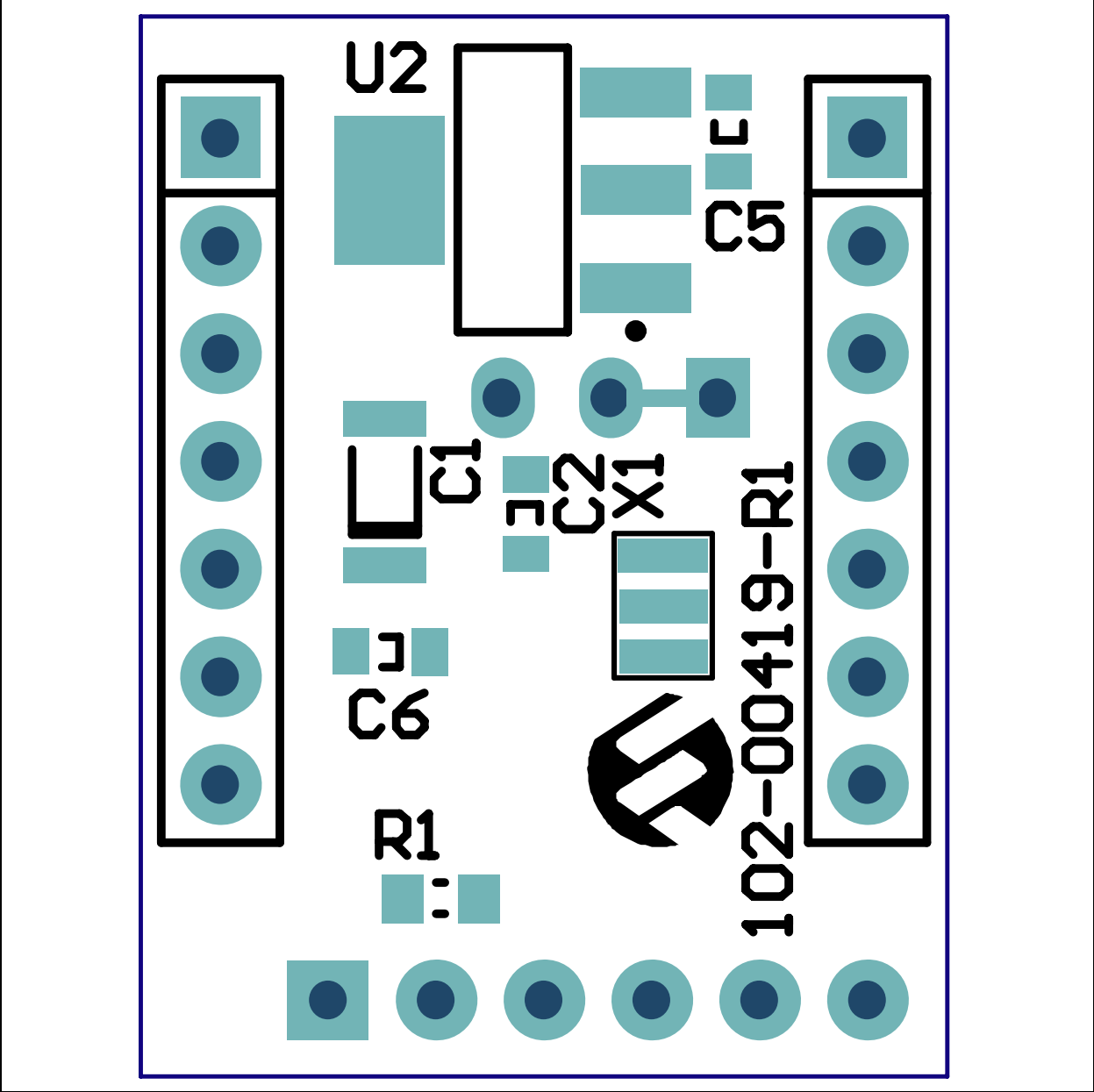

A.7 BOARD – BOTTOM SILK, PADS AND COPPER

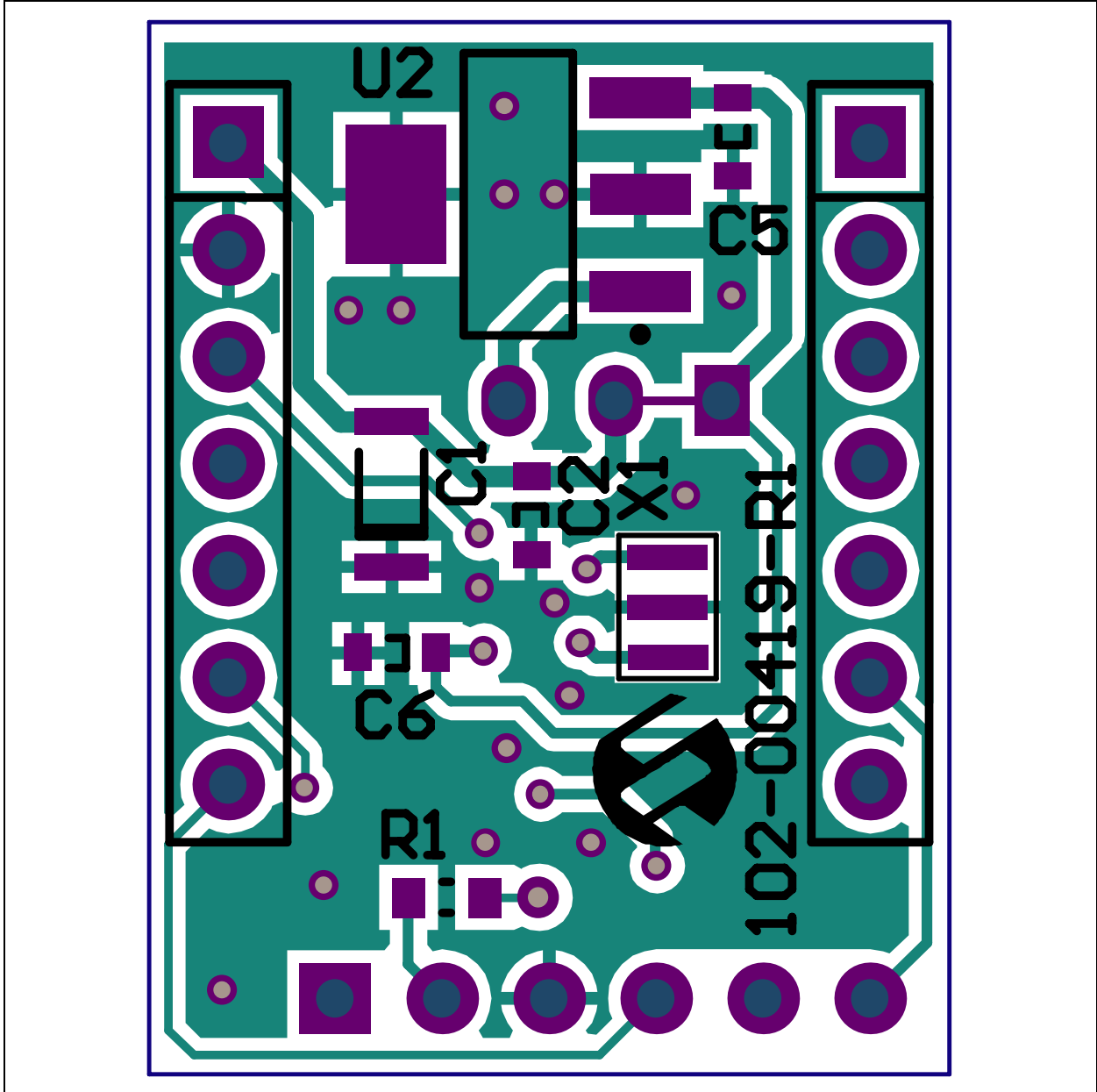

MCP2210 Breakout Module User's Guide

A.8 BOARD – BOTTOM PADS AND COPPER

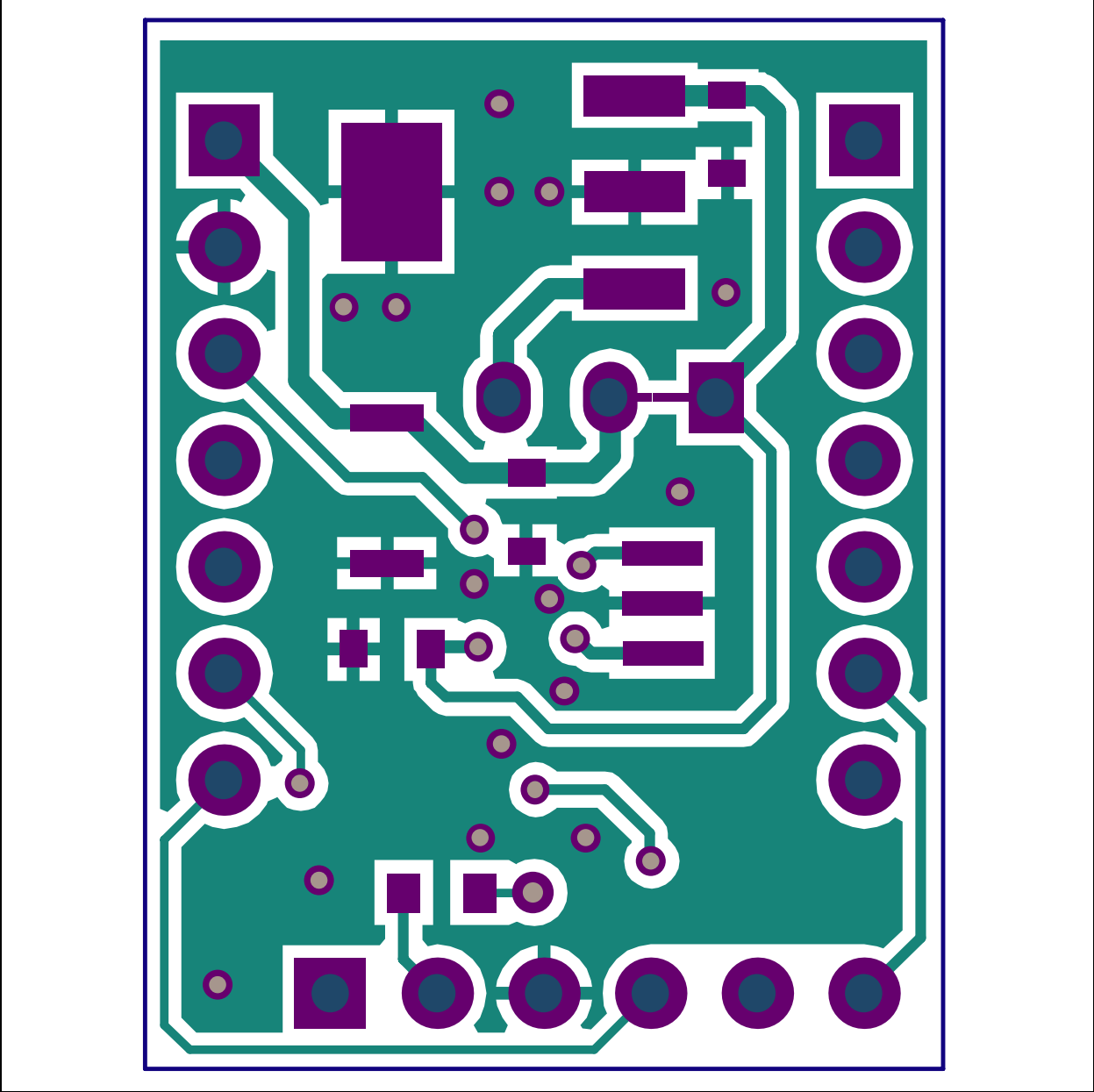

Appendix B. Bill of Materials

TABLE B-1: BILL OF MATERIALS

Qty	Designator	Description	Manufacturer 1	Part Number
1	C1	Cap. Cerm. 22 uF 10V 20% Y5V 1206	TDK [®] Corporation	C3216Y5V1A226Z
3	C2, C4, C5	Cap. Cerm. .1 uF 10% 16V X7R 0603	AVX Corporation	0603YC104KAT2A
1	C3	Cap. Cerm. 4.7 uF 6.3V 10% X5R 0603	TDK Corporation	C1608X5R0J475K
1	C6	Cap. Cerm. 1 uF 16V 10% X7R 0603	TDK Corporation	C1608X7R1C105K
2	J1, J2	DO NOT POPULATE Conn. Hdr. Male .100 1x7 Pos. Vertical	Tyco [®] Electronics	HDR M 1x7 Vertical
1	J3	DO NOT POPULATE Conn. Hdr. Male .100 1x6 Pos. Vertical	Tyco Electronics	HDR M 1x6 Vertical
1	J4	DO NOT POPULATE Conn. Hdr. Male .100 1x3 Pos. Vertical	Tyco Electronics	HDR M 1x3 Vertical
1	J5	Conn. Rcpt. USB Mini B R/A SMD	Hirose Electric Co. Ltd.	UX60SC-MB-5ST(80)
1	R1	Res. 390 Ohm 1/10W 5% 0603 SMD	Panasonic [®] - ECG	ERJ-3GEYJ391V
1	U1	IC USB-TO-SPI SSOP-20	Microchip Technology Inc.	MCP2210-I/SS
1	U2	IC LDO Reg. 500 mA 3.3V SOT-223-3	Microchip Technology Inc.	MCP1825S-3302E/DB
1	X1	Cer. Resonator 12.0 MHz SMD	Murata Electronics [®]	CSTCE12M0G55-R0

Note 1: The components listed in this Bill of Materials are representative of the PCB assembly. The released BOM used in manufacturing uses all RoHS-compliant components.



MICROCHIP

Worldwide Sales and Service

AMERICAS

Corporate Office

2355 West Chandler Blvd.
Chandler, AZ 85224-6199
Tel: 480-792-7200
Fax: 480-792-7277
Technical Support:
<http://www.microchip.com/support>
Web Address:
www.microchip.com

Atlanta

Duluth, GA
Tel: 678-957-9614
Fax: 678-957-1455

Boston

Westborough, MA
Tel: 774-760-0087
Fax: 774-760-0088

Chicago

Itasca, IL
Tel: 630-285-0071
Fax: 630-285-0075

Cleveland

Independence, OH
Tel: 216-447-0464
Fax: 216-447-0643

Dallas

Addison, TX
Tel: 972-818-7423
Fax: 972-818-2924

Detroit

Farmington Hills, MI
Tel: 248-538-2250
Fax: 248-538-2260

Indianapolis

Noblesville, IN
Tel: 317-773-8323
Fax: 317-773-5453

Los Angeles

Mission Viejo, CA
Tel: 949-462-9523
Fax: 949-462-9608

Santa Clara

Santa Clara, CA
Tel: 408-961-6444
Fax: 408-961-6445

Toronto

Mississauga, Ontario,
Canada
Tel: 905-673-0699
Fax: 905-673-6509

ASIA/PACIFIC

Asia Pacific Office

Suites 3707-14, 37th Floor
Tower 6, The Gateway
Harbour City, Kowloon
Hong Kong
Tel: 852-2401-1200
Fax: 852-2401-3431

Australia - Sydney

Tel: 61-2-9868-6733
Fax: 61-2-9868-6755

China - Beijing

Tel: 86-10-8569-7000
Fax: 86-10-8528-2104

China - Chengdu

Tel: 86-28-8665-5511
Fax: 86-28-8665-7889

China - Chongqing

Tel: 86-23-8980-9588
Fax: 86-23-8980-9500

China - Hangzhou

Tel: 86-571-2819-3187
Fax: 86-571-2819-3189

China - Hong Kong SAR

Tel: 852-2401-1200
Fax: 852-2401-3431

China - Nanjing

Tel: 86-25-8473-2460
Fax: 86-25-8473-2470

China - Qingdao

Tel: 86-532-8502-7355
Fax: 86-532-8502-7205

China - Shanghai

Tel: 86-21-5407-5533
Fax: 86-21-5407-5066

China - Shenyang

Tel: 86-24-2334-2829
Fax: 86-24-2334-2393

China - Shenzhen

Tel: 86-755-8203-2660
Fax: 86-755-8203-1760

China - Wuhan

Tel: 86-27-5980-5300
Fax: 86-27-5980-5118

China - Xian

Tel: 86-29-8833-7252
Fax: 86-29-8833-7256

China - Xiamen

Tel: 86-592-2388138
Fax: 86-592-2388130

China - Zhuhai

Tel: 86-756-3210040
Fax: 86-756-3210049

ASIA/PACIFIC

India - Bangalore

Tel: 91-80-3090-4444
Fax: 91-80-3090-4123

India - New Delhi

Tel: 91-11-4160-8631
Fax: 91-11-4160-8632

India - Pune

Tel: 91-20-2566-1512
Fax: 91-20-2566-1513

Japan - Osaka

Tel: 81-66-152-7160
Fax: 81-66-152-9310

Japan - Yokohama

Tel: 81-45-471-6166
Fax: 81-45-471-6122

Korea - Daegu

Tel: 82-53-744-4301
Fax: 82-53-744-4302

Korea - Seoul

Tel: 82-2-554-7200
Fax: 82-2-558-5932 or
82-2-558-5934

Malaysia - Kuala Lumpur

Tel: 60-3-6201-9857
Fax: 60-3-6201-9859

Malaysia - Penang

Tel: 60-4-227-8870
Fax: 60-4-227-4068

Philippines - Manila

Tel: 63-2-634-9065
Fax: 63-2-634-9069

Singapore

Tel: 65-6334-8870
Fax: 65-6334-8850

Taiwan - Hsin Chu

Tel: 886-3-5778-366
Fax: 886-3-5770-955

Taiwan - Kaohsiung

Tel: 886-7-536-4818
Fax: 886-7-330-9305

Taiwan - Taipei

Tel: 886-2-2500-6610
Fax: 886-2-2508-0102

Thailand - Bangkok

Tel: 66-2-694-1351
Fax: 66-2-694-1350

EUROPE

Austria - Wels

Tel: 43-7242-2244-39
Fax: 43-7242-2244-393

Denmark - Copenhagen

Tel: 45-4450-2828
Fax: 45-4485-2829

France - Paris

Tel: 33-1-69-53-63-20
Fax: 33-1-69-30-90-79

Germany - Munich

Tel: 49-89-627-144-0
Fax: 49-89-627-144-44

Italy - Milan

Tel: 39-0331-742611
Fax: 39-0331-466781

Netherlands - Drunen

Tel: 31-416-690399
Fax: 31-416-690340

Spain - Madrid

Tel: 34-91-708-08-90
Fax: 34-91-708-08-91

UK - Wokingham

Tel: 44-118-921-5869
Fax: 44-118-921-5820

11/29/11