



Passive components sales offices

• Head office

206, Cheomdansaneop Road,
Yeongtong-gu, Suwon-city,
Gyeonggi province, Korea,
443-743

Europe
Tel: +82-31-210-6328
E-mail: james.pyun@samsung.com

America
Tel: +82-31-210-6803
E-mail: wesley.roh@samsung.com

Asia
Tel: +82-31-210-6791
E-mail: peter.kim@samsung.com

Domestic
Tel: +82-31-210-5074
E-mail: boungho.lee@samsung.com

• Manufacturing sites

Suwon Plant (Korea)
206, Cheomdansaneop Road,
Yeongtong-gu, Suwon-city,
Gyeonggi province, Korea,
443-743
Tel: +82-31-210-5074
E-mail: boungho.lee@samsung.com

Busan Plant (Korea)
1623-2, Songjeong-dong,
Gangseo-gu, Busan, Korea,
618-270
Tel: +82-51-970-7671
E-mail: kyc.kweon@samsung.com

Tianjin Plant (China)
27, Heiniucheng-Road, Hexi District,
Tianjin, 300210 China
Tel: +86-22-2397-9000(310)
E-mail: moohantop.Park@samsung.com

High Tech (China)
Xiqing Dist. Micro-Electronics
Industrial Park, Jingang Highway,
Tianjin, China 300485
Tel: +86-22-23979000-313
E-mail: enhao.song@samsung.com

Binhai Plant (China)
80, Xiaqing Road, West area of
BinHai development zone,
TianJin, 300458, China
Tel: +86-22-6686-3333(1300)
E-mail: sk1000.kim@samsung.com

• Asia sales offices

Philippines Plant (Philippines)
Block No.5, Calamba Premiere
International Park, Batino, Calamba,
Laguna, Manila, Philippines 4027
Tel: +63-49-545-0422
E-mail: donna@samsung.com

• Asia sales offices

Shenzhen Office
46 F, New World Center,
Yitian Road, Futian District,
Shenzhen, 518026 China
Tel: +86-755-8608-5571
E-mail: jackson.xian@samsung.com

Shanghai Office
Rm. 1211, Shanghai International
Trade Center, No. 2201 Yan an(W) Rd.,
Shanghai, 200335 China
Tel: +86-21-6270-4168(274)
E-mail: dennis.cha@samsung.com

HongKong Office
8/F., Central Plaza, 18 Harbour Road,
Wanchai, Hongkong, China
Tel: +852-28626344
E-mail: vivianchan@samsung.com

Qingdao Office
Rm 1201, Growne Plaza Qingdao 76,
Xiang Gang Zhong Rd, Qingdao,
266071 China
Tel: +86-532-85779102
E-mail: zhengguo.cui@samsung.com

Taiwan Office
9F-1, Np. 399 Ruey Kuang Rd., Neihu
District, Taipei City, Taiwan, 114
Tel: +886-2-2656-8356
E-mail: kevin0130.wang@samsung.com

Singapore Office
3 Church Street Samsung Hub,
#23-02 Singapore 049483
Tel: +65-6833-3228
E-mail: winson.yeong@samsung.com

Bangkok Office
23rd Floor, Lake Rajada Office Complex
193/89 Rachadapisek Road,
Khet Klongtoey, Bangkok 10110, Thailand
Tel: +66-2-661-8004~5
E-mail: yangshin.yi@samsung.com

• America sales office

Irvine Office
3333 Michelson Drive,
Suite 500, Irvine, CA 92612, USA
Tel: 1-949-797-8016
E-mail: andrew.skelly@samsung.com

• Europe sales offices

Frankfurt Office
Samsung Haus, Am Kronberger Hang 6,
D-65824 Schwalbach/Ts. Germany
Tel: +49-6196-66-7255
E-mail: frank.goebel@samsung.com

Hungary Office
H-2310, Leshegy utca 2-4,
Szigetszentmiklos, Pest megye, Hungary
Tel: +36-24-551-148
E-mail: jun21c.lee@samsung.com

• Domestic Distributors

Korchip Corporation
817-38, Anyang 2-dong, Manan-gu,
Anyang-city, Gyeonggi province,
Korea, 430-812
Tel: +82-31-361-8100
E-mail: itasap@korchip.com

SAMT
Daekyung Bldg., 983-10, Daechi-dong,
Gangnam-gu, Seoul, Korea
Tel: +82-2-3458-9000
E-mail: info@isamt.com

CHUNGMAC
301 Gwonseon Medivill, 544-14
Gokbanjeong-dong, Gwonseon-gu,
Suwon-si, Gyeonggi-do Korea
Tel: +82-31-234-2367~8
E-mail: webmaster@chungmac.co.kr

YOUNGDUK
Gasam-Dong 632, Seobusaetgil,
Geumcheon-Gu, Seoul, Korea
Tel: +82-2-2107-7860
E-mail: siyang1109@gmail.com

THICK-FILM CHIP RESISTOR





We, Samsung, declare that our component Chip Resistor is produced in accordance with EU RoHS directive.

1. RoHS Compliance and restriction of Br

The following restricted materials are not used in packaging materials as well as products in compliance with the law and restriction.

- Cd, Pb, Hg, Cr+6, As, Br and the compounds, PCB, asbestos
- Bromic materials : PBBs, PBBOs, PBDO, PBDE, PBB

2. No use of materials breaking Ozone layer

The following ODS materials are not used in our fabrication process.

- ODS material : Freon, Haron, 1-1-1 TCE, CCl4, HCFC

If you want more detailed Information, Please Visit Samsung Electro-mechanics Website
<http://www.sem.samsung.com>, <http://www.sem1cr.com>]

CONTENTS

Operation Notes	4	Operation Notes
Example of Land Pattern Design	5	Example of land Pattern Design
Recommended Soldering Conditions	6	Recommended Soldering Conditions
General Structure	7	General Structure
General	8	General
Precision	10	Precision
Jumper	12	Jumper
Low ohms(RUT Series)	14	Low ohms (RUT Series)
Ultra Low Ohms(RU Series)	16	Ultra Low ohms (RU Series)
Ultra Low Ohms(RUK Series)	18	Ultra Low Ohms (RUK Series)
Ultra Low Ohms(RJ Series)	20	Ultra Low Ohms (RJ Series)
Arrays(CONVEX Type)	22	Arrays (CONVEX Type)
Arrays(CONCAVE Type)	24	Arrays (CONCAVE Type)
Arrays(FLAT Type)	26	Arrays (FLAT Type)
Anti-Sulfur Resistors	28	Anti-Sulfur Resistors
Attenuator	30	Attenuator
Characteristics Performance	32	Characteristics Performance
Packaging	34	Packaging
Standard Resistance Value	36	Standard Resistance Value

Applications

- Chip resistors are designed for general electronic devices such as home appliances, computer, mobile communications, digital circuit, etc. If you require our products with high reliability-performing at more than 125°C or below -55°C- for medical equipments, aircrafts, high speed machines, military usage, and items that can affect human life or if you need to use in specific conditions (corrosive gas atmosphere like H₂S etc.), please contact us beforehand.
- Normal operation temperature ranges (°C): -55°C~+155°C
- Others (rectangular, array_Flat type, trimmable): -55°C~+125°C
- Although resistor body is coated, sharp excessive impact should be avoided to prevent damages and adverse effects on characteristics (resistor value, open circuited, T.C.R.).

Mounting

Please give more attention not to press the chip owing to the nozzle's improper height when it is mounted on PCB. (Excessive pressure may cause exterior damage, change in resistance, circuit open, etc.)

Safety precautions

- These products are designed and produced for applying to the ordinary electronic equipments. (AV equipment, OA equipment, Telecommunication equipment, etc)
- Consult with our sales department before applying in the devices that require extremely high reliability such as medical equipments, transport equipments, aircrafts/ spacecrafts, nuclear power controllers, fuel controllers, car equipments including car accessories and other safety devices.
- Following special environments, and such environmental conditions may affect the performance of the product. Please verify the performance and reliability thoroughly prior to use.
 - Using in various type of Liquid including water, oil, organic solvent and other chemicals.
 - Using in the places where the products are exposed to direct sunlight, sea wind, corrosive gases (including Cl₂, H₂S, NH₃, SO₂, NO₂), static electricity, electromagnetic waves and dusty air.
 - Using close to heat generating components or other flammable items.
 - Using in the places that is sealed or coated with resins or other coating materials after soldering.
 - Using in places subject to dew condensation.
- These products are not radiation resistant.
- The company is not responsible for any problems resulting from using of the products under the conditions not recommended herein.
- The company should notify any safety issues of the products to the customer. And the safety of the products should be monitored by the customer periodically.

Storage

To maintain proper quality of chip components, the following precautions are required for storage environment, method and period.

- Storage Environment
 - Make sure that the ambient temperature is within 5°C~40°C and the ambient humidity is within 20~70%RH.
 - Chip components may be deformed, if the temperature of packaged components exceeds 40°C.
 - Do not store where the soldering properties can be deteriorated by harmful gas such as sulphurous gas, chlorine gas, etc.
 - Bulk packed chip components should be used as soon as the seal is opened, thus preventing the solderability from deteriorating.
 - The remaining unused chips should be put in the original bag and sealed again or store in a desiccator containing a desiccating agent.
- Storage Time Period
 - Stored chip components should be used within 6 months after receiving the components. If 6 months or more have elapsed, please check the solderability before actually using.

Cleaning

After Soldering Cleaning, soldering flux & Ionic cleaning liquid should be avoided on product. If any possibility on product, please take a test before usage.

Caution for Chip Resistor Separation from PCB.

Chip resistor installation on PCB is a similar phenomenon on to a chocolate chip on top of a cake. PCB has enough flexibility on outer force but Chip resistor can be defected without any bending. (By chip resistor use of Ceramic, solder, metal) Therefore, when separating a Chip resistor from a PCB, beware of any crack on the chip.

Others

- Manual work
 - Whenever separating chip resistor from PCB, do not re-use the chip resistor for circuit safety. Electrical specification of chip resistors can be changed by soldering iron after separation. Re-use of separated chip resistor should be prohibited.
- Do not use more than rated voltage. (Please check the contents of each product)

Example of Land Pattern Design

- When designing P.C.B, the shape and size of the solder lands must allow a proper amount of solder to form under the resistor. The amount of solder formed at the end terminations has direct effect on the possibility of chip crack. The more the amount of solder and stress, the more the possibilities of chip crack.

For Chip Type

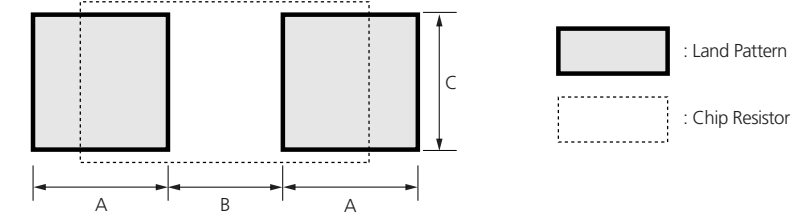

• Reflow soldering (UNIT: mm)					• Reflow soldering(RU,RUW,RUK) (UNIT: mm)					• Flow soldering (UNIT: mm)				
Type	A	B	2A+B	C	Type	A	B	2A+B	C	Type	A	B	2A+B	C
0402	0.17	0.20	0.54	0.18	1005	0.8	0.5	2.1	0.5	1005	0.7	0.5	1.9	0.5
0603	0.37	0.28	1.02	0.29	1608	0.8	0.5	2.1	0.8	1608	0.9	0.8	2.6	0.8
1005	0.6	0.5	1.7	0.5	2012	0.9	0.8	2.6	1.2	2012	1.0	1.4	3.4	1.3
1608	0.8	0.8	2.4	0.8	3216	1.7	1.2	4.6	1.4	3216	1.4	1.8	4.6	1.6
2012	0.9	1.4	3.2	1.2	3225	1.7	1.2	4.6	2.6	3225	1.4	1.8	4.6	2.6
3216	1.3	1.8	4.4	1.5	5025	2.15	1.8	6.1	2.6	5025	1.5	3.3	6.3	2.5
3225	1.3	1.8	4.4	2.4	6432	2.3	3.0	7.6	3.3	6432	1.5	4.6	7.6	3.2
5025	1.4	3.3	6.1	2.4										
6432	1.4	4.6	7.4	3.0										

For Array Type

• Convex type

Type	A	B	C	D	E	P ₁	P ₂
062P	0.20	0.20	0.30	0.30	0.30	0.6	-
064P	0.20	0.20	0.20	0.30	0.30	0.5	0.5
10AT	0.4	0.4	0.25	0.5	0.5	0.65	-
102P	0.4	0.4	0.25	0.5	0.5	0.65	-
104P	0.7	0.3	0.2	0.5	0.5	0.55	0.5
164P	0.7	0.5	0.3	0.9	0.8	0.9	0.8

• Concave type

Type	A	B	C	D	E	P
102P	0.3	0.3	0.2	0.5	0.4	0.5
104P	0.3	0.3	0.2	0.5	0.4	0.5

- This is the recommended land pattern for designing PCB. This pattern does not guarantee any characteristic of other product.

The specifications and designs contained herein may be subject to change without notice. Please contact our sales representatives or product engineers before order.

Operation Notes

Example of land Pattern Design

Recommended Soldering Conditions

General Structure

General

Precision

Jumper

Low ohms (RUT Series)

Ultra Low ohms (RU Series)

Ultra Low Ohms (RUK Series)

Ultra Low Ohms (RJ Series)

Arrays (CONVEX Type)

Arrays (CONCAVE Type)

Arrays (FLAT Type)

Anti-Sulfur Resistors

Attenuator

Characteristics Performance

Packaging

Standard Resistance Value

Abstract

- There are 3 soldering methods.
 - Flow(wave) soldering.
 - Reflow soldering. (Reflow soldering is broadly divided into the total heating method and local heating method.)
 - Iron soldering.

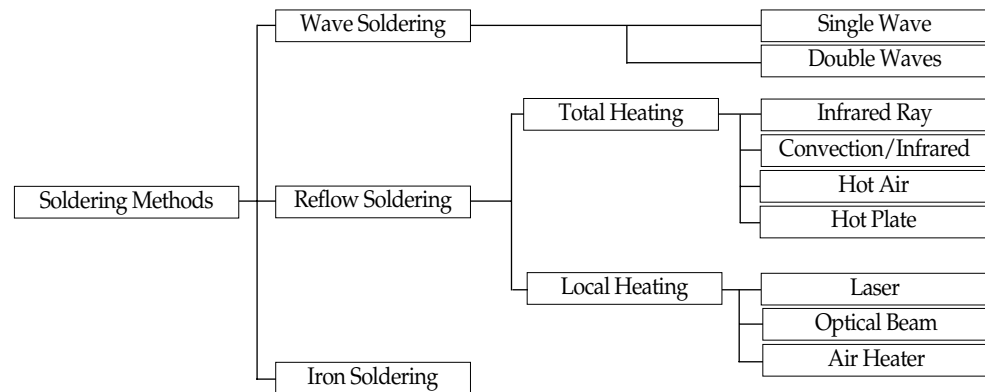

Since Chip resistors come into direct contact with melted solder during soldering, it is exposed to potential mechanical stress caused by the sudden temperature change. The chip resistors may also be subject to silver migration and flux contamination.

Flow(wave) Soldering

- Features

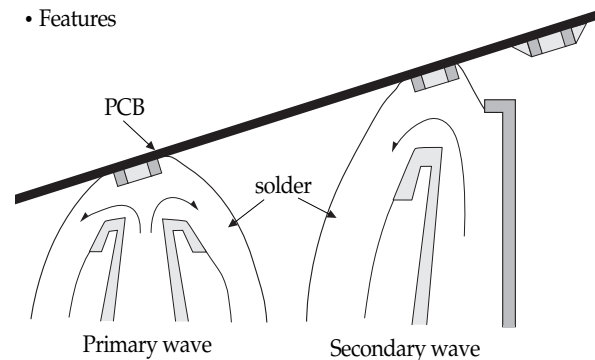

There are two types of soldering methods in flow(wave) soldering. One is single wave soldering, and the other is a double waves soldering. However, double waves soldering is mainly used. This method is designed for continuous and multiple dipping process by using primary and secondary wave, having completely different waveforms and characteristics. With the primary wave, a comparatively strong jet flow is used to remove the flux gas and to solder. With the secondary wave, it is used to remove excessive solder. With the primary wave, the solder flows into a very small gap between components and air bubbles remaining on the soldered joint are removed. With the secondary wave, the peel back is used to prevent bridging.

- Preheating

If a chip component is heated suddenly during soldering, it may crack by the thermal shock caused by the temperature difference between the surface and the inside of the chip. To prevent this, a full preheating is necessary. In case of wave soldering, the temperature difference between solder and surface of the component should be kept within 150°C. Also when cooling is done by dipping into solvent, care should be taken to keep the temperature difference within 150°C.

- Standard Soldering Condition

Soldering must be carried out without exceeding the approved soldering temperature and time shown within the shaded area of the graph at right. An excessively long soldering time or high soldering temperature results in leaching of outer terminations. When a PCB is warped, mechanical stress applied to the chip will be increased and might cause chip crack, especially if there is a big amount of solder on the chip. So, care should be taken not to use excessive amount of solder on the PCB. For the flow(wave) soldering, the solder amount can be controlled by land size.

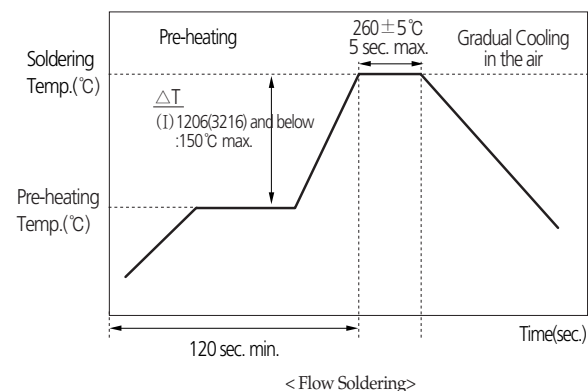

Reflow Soldering

- Pre-heating and cooling
In the reflow soldering method, a full pre-heating at the proper temperature is necessary to dry and activate solder paste. Tomb-stoning can be reduced by preheating at 150~180°C for more than 1 minute. Also when cooling is done by dipping into solvent, care should be taken to keep the temperature difference within 150°C.

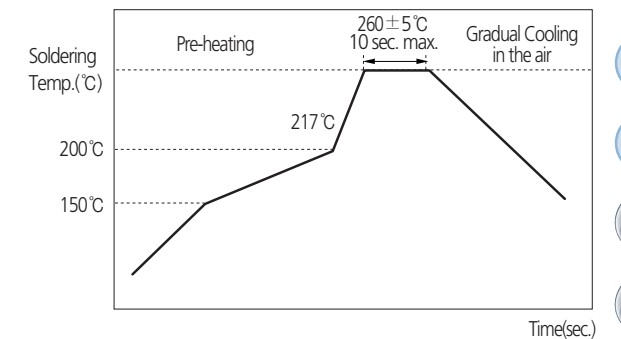

- Standard Reflow Soldering Condition
Soldering must be carried out without exceeding the approved soldering temperature and time shown within the shaded area of the right graph. This prevents the terminations from leaching and characteristics from deteriorating. When soldering is repeated, the allowed time is the accumulated time.

- Standard solder amount

When a PCB is warped, mechanical stress applied to the chip should be reduced, and to do so, care should be taken not to use excessive amount of solder on the PCB. In the case of the reflow method, the thickness of the coated solder paste is controlled to prevent excessive solder. The thickness of solder paste should be 100~300μm.

- Tombstoning and Prevention

When reflow soldering, or especially vapor phase soldering (VPS), small chip components of less than RC3216 type may break away from solder and stand on end. This is commonly known as tombstoning or the Manhattan phenomenon.

- Preventing tombstoning

Keep land size as small as possible.
Keep the pre-heating conditions properly
(Pre-heating temperature : 150 ~ 180°, Pre-heating time : more than 1 min.)
Keep the solder paste quantity not too much and uniform for every lands.
Keep the position of chips properly.
At around the soldering temperature, keep minimum difference of the temperature between the electrodes of a chip.

Iron Soldering

When using a soldering iron or any other soldering operation, the permissible temperature and time should not exceed that of the reflow soldering. In order to prevent the external terminations from leaching and characteristics from deteriorating, the tip of the soldering iron should not touch the chip component (ceramic element, resin case, etc.). Soldering with a soldering iron and correcting with a soldering iron can be performed right under following conditions.

Item	Condition
Temperature at tip	350°C Max.
Soldering iron output	20-Watt Max.
End of soldering iron	∅3mm Max.
Note	Do not directly touch the chip by the tip of the iron.

General Structure of the Chip Resistor

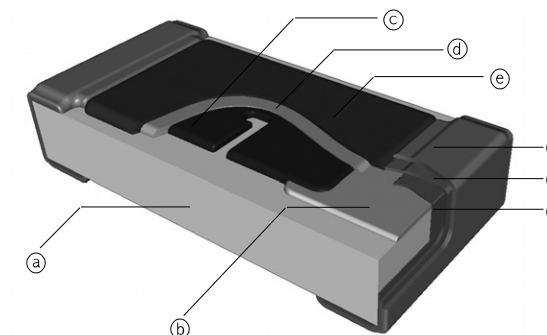

No.	Name	Main Substance
(a)	Ceramic Substrate	Al ₂ O ₃
(b)	Inner Electrode	Ag
(c)	Resistor	RuO ₂
(d)	Glass Coat	Bi ₂ O ₃ , SiO ₂
(e)	Protective Coat	Polymer / Glass
(f)	Terminal Coat	Ni-Cr Alloy / Ag
(g)	Ni Plate	Ni
(h)	Sn Plate	Sn

The specifications and designs contained herein may be subject to change without notice. Please contact our sales representatives or product engineers before order.

Operation Notes

Example of land Pattern Design

Recommended Soldering Conditions

General Structure

General

Precision

Jumper

Low ohms (RUT Series)

Ultra Low ohms (RU Series)

Ultra Low Ohms (RUK Series)

Ultra Low Ohms (RJ Series)

Arrays (CONVEX Type)

Arrays (CONCAVE Type)

Arrays (FLAT Type)

Anti-Sulfur Resistors

Attenuator

Characteristics Performance

Packaging

Standard Resistance Value

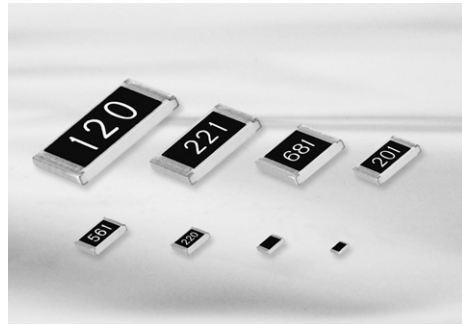

Feature

- Very small, thin, and light weight.
- Both flow and reflow soldering are applicable.
- Very low inductance.
- Suitable size and packaging for surface mount assembly.
- Lead-free terminal.
- PbO(lead oxide) is included in the glass of our product which is prescribed on RoHS appendix as an exemption.

Application

- General purpose.
- Home Appliances. (DVD, Digital TV, Digital Camera, Audio, Tunner).
- For Computers & Communications. (Notebook, Memory Module, Mobile, Network Equipment, etc).

Structure and Dimensions

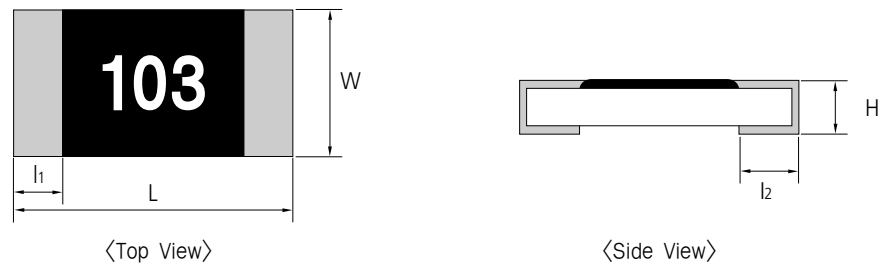

(UNIT: mm)

Type	Inch	L	W	H	l ₁	l ₂	Average Weight
RC0402	01005	0.40±0.02	0.20±0.02	0.13±0.02	0.10±0.03	0.10±0.03	0.04mg
RC0603	0201	0.60±0.03	0.30±0.03	0.23±0.03	0.10±0.05	0.15±0.05	0.15mg
RC1005	0402	1.00±0.05	0.50±0.05	0.35±0.05	0.20±0.10	0.25±0.10	0.6mg
RC1608	0603	1.60±0.10	0.80±0.10	0.45±0.10	0.30±0.20	0.35±0.10	2.1mg
RC2012	0805	2.00±0.15	1.25±0.15	0.50±0.10	0.40±0.20	0.35±0.20	4.9mg
RC3216	1206	3.20±0.15	1.60±0.15	0.55±0.10	0.45±0.20	0.40±0.20	9.5mg
RC3225	1210	3.20±0.20	2.55±0.20	0.55±0.10	0.45±0.20	0.40±0.20	16mg
RC5025	2010	5.00±0.20	2.50±0.20	0.55±0.10	0.60±0.20	0.60±0.20	26mg
RC6432	2512	6.30±0.20	3.20±0.20	0.55±0.10	0.60±0.20	0.60±0.20	41mg

Parts Numbering System

• The part number system shall be in the following format

RC	2012	J	100	CS
Code Designation	Dimension & Size Code	Tolerance	Resistance Value	Packaging Code
RC: Chip Resistor	0402: 0.4 × 0.2(mm) - 01005(inch) 0603: 0.6 × 0.3(mm) - 0201(inch) 1005: 1.0 × 0.5(mm) - 0402(inch) 1608: 1.6 × 0.8(mm) - 0603(inch) 2012: 2.0 × 1.2(mm) - 0805(inch) 3216: 3.2 × 1.6(mm) - 1206(inch) 3225: 3.2 × 2.5(mm) - 1210(inch) 5025: 5.0 × 2.5(mm) - 2010(inch) 6432: 6.4 × 3.2(mm) - 2512(inch)	F : ±1% G : ±2% J : ±5% K : ±10%	3 or 4 digits coding system (IEC coding system) 3digits (E-24 series) 4digits (E-96 series)	GS: Bulk Packaging CS: Tape Packaging 7" ES: Tape Packaging 10" AS: Tape Packaging 13"

Specification

Type	Power Rating (W)	Working Voltage (MAX)	Overload Voltage (MAX)	TCR (ppm/°C)	Resistance Range (Ω)	Rated Ambient Temperature	Rated Working Temperature
RC 0402	1/32	15(V)	30(V)	1~99 Ω : ±300 100~1 MΩ : ±250	1 Ω ~1 MΩ	70°C	-55°C ~+125°C
RC 0603	1/20	25(V)	50(V)	1~9.9 Ω : +300,-200 10 Ω ~1 MΩ : ±100 (0603 : ±250) 1.1 MΩ ~10 MΩ : ±300	1 Ω ~10 MΩ		-55°C ~+155°C
RC 1005	1/16	50(V)	100(V)				
RC 1608	1/10						
RC 2012	1/8	150(V)	300(V)				
RC 3216	1/4						
RC 3225	1/3						
RC 5025	2/3	200(V)	400(V)				
RC 6432	1						

• Rated voltage (V) = $\sqrt{\text{Rated power(W)} \times \text{Nominal resistance value } (\Omega)}$
Rated voltage should be lower than (MAX) working voltage.

Power Derating Curve

The rated power is the maximum continuous loading power at 70°C ambient temperature. For ambient temperature above 70°C, the loading power follows the below power derating curve. (The load current shall be derated according to derating curve in case of the 'Jumper')

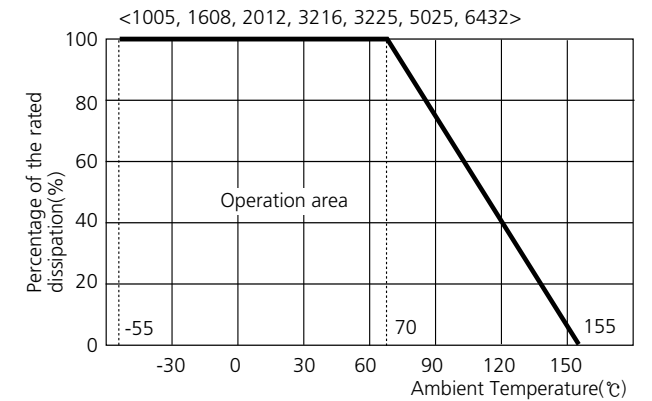
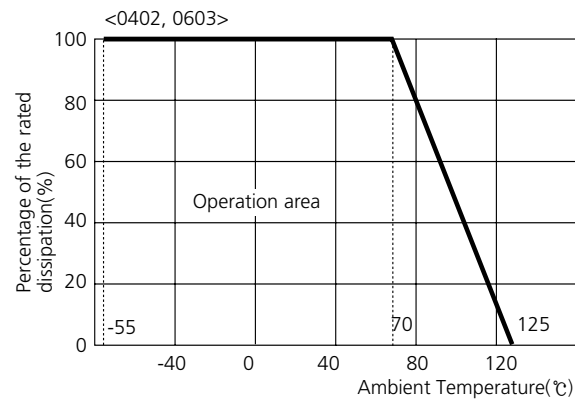

Marking

• 3 digits indication (E-24 series)	• 4 digits indication (E-96 series)
- Left 2 digits represent significant figures. - Last 1 digit represents exponential number of 10. - Example: 103 Left 2 digits: 10 Last 1 digit: 3 $103 = 10 \times 10^3 \Omega = 10000 \Omega = 10k \Omega$	- Left 3 digits represent significant figures. - Last 1 digit represents exponential number of 10. - Example: 1002 Left 3 digits: 100 Last 1 digit: 2 $1002 = 100 \times 10^2 \Omega = 10000 \Omega = 10k \Omega$
• 0603, 1005 type: No marking.	• 0603, 1005, 1608 type: No marking.

IEC Code System (E-96, E-24)

E-96	E-24	E-96	E-24	E-96	E-24	E-96	E-24
100	10	178		316		562	56
102		182	18	324	33	576	
105		187		332		590	
107		191		340		604	
110	11	196		348		619	
113		200	20	357	36	634	62
115		205		365		649	
118		210		374		665	
121	12	215		383	39	681	68
124		221	22	392		698	
127		226		402		715	
130	13	232		412		732	
133		237		422		750	75
137		243	24	432	43	768	
140		249		442		787	
143		255		453		806	
147		261		464		825	82
150	15	267		475	47	845	
154		274	27	487		866	
158		280		499		887	
162	16	287		511	51	909	
165		294		523		931	91
169		301	30	536		953	
174		309		549		976	

The specifications and designs contained herein may be subject to change without notice. Please contact our sales representatives or product engineers before order.

- Operation Notes
- Example of land Pattern Design
- Recommended Soldering Conditions
- General Structure
- General
- Precision
- Jumper
- Low ohms (RUT Series)
- Ultra Low ohms (RU Series)
- Ultra Low Ohms (RUK Series)
- Ultra Low Ohms (RJ Series)
- Arrays (CONVEX Type)
- Arrays (CONCAVE Type)
- Arrays (FLAT Type)
- Anti-Sulfur Resistors
- Attenuator
- Characteristics Performance
- Packaging
- Standard Resistance Value

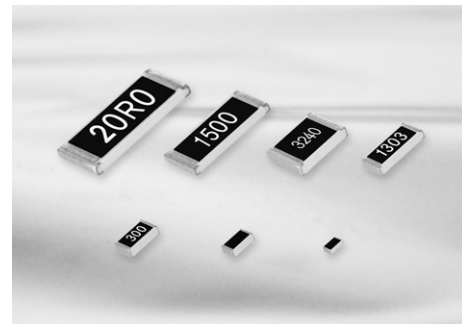

Feature

- Low tolerance (±0.5%).
- Both flow and reflow soldering are applicable.
- Suitable size and packaging for surface mount assembly.
- Very low inductance.
- Lead-free terminal.
- PbO(lead oxide) is included in the glass of our product which is prescribed on RoHS appendix as an exemption.

Application

- Circuit for high precision resistance and reliability.
- For signal control part.
- For tuning circuit.

Structure and Dimensions

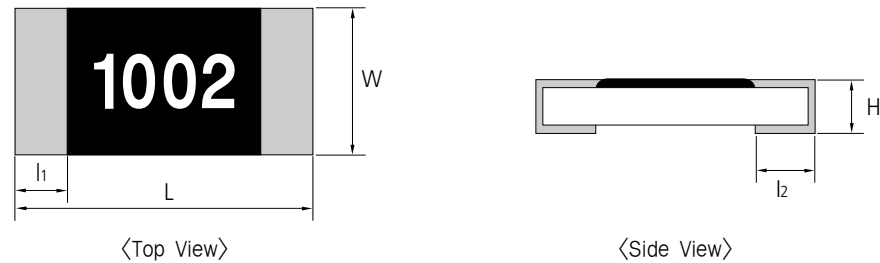

(UNIT: mm)

Type	Inch	L	W	H	l ₁	l ₂	Average Weight
RC1005	0402	1.00±0.05	0.50±0.05	0.35±0.05	0.20±0.10	0.25±0.10	0.6mg
RC1608	0603	1.60±0.10	0.80±0.10	0.45±0.10	0.30±0.20	0.35±0.10	2.1mg
RC2012	0805	2.00±0.15	1.25±0.15	0.50±0.10	0.40±0.20	0.35±0.20	4.9mg
RC3216	1206	3.20±0.15	1.60±0.15	0.55±0.10	0.45±0.20	0.40±0.20	9.5mg
RC3225	1210	3.20±0.20	2.55±0.20	0.55±0.10	0.45±0.20	0.40±0.20	16mg
RC5025	2010	5.00±0.20	2.50±0.20	0.55±0.10	0.60±0.20	0.60±0.20	26mg
RC6432	2512	6.30±0.20	3.20±0.20	0.55±0.10	0.60±0.20	0.60±0.20	41mg

Parts Numbering System

• The part number system shall be in the following format

RC	1005	D	1002	CS
Code Designation	Dimension & Size Code	Tolerance	Resistance Value	Packaging Code
RC: Chip Resistor	1005: 1.0 × 0.5(mm) - 0402(inch) 1608: 1.6 × 0.8(mm) - 0603(inch) 2012: 2.0 × 1.2(mm) - 0805(inch) 3216: 3.2 × 1.6(mm) - 1206(inch) 3225: 3.2 × 2.5(mm) - 1210(inch) 5025: 5.0 × 2.5(mm) - 2010(inch) 6432: 6.4 × 3.2(mm) - 2512(inch)	D: ±0.5%	3 or 4 digits coding system (IEC coding system) 3digits (E-24 series) 4digits (E-96, E-192 series)	GS: Bulk Packaging CS: Tape Packaging 7" ES: Tape Packaging 10" AS: Tape Packaging 13"

Specification

Type	Power Rating (W)	Working Voltage (MAX)	Overload Voltage (MAX)	TCR (ppm/°C)	Resistance Range (Ω)	Rated Ambient Temperature	Rated Working Temperature
RC 1005	1/16	50(V)	100(V)	1-9.9Ω :±300 10Ω~1 MΩ :±100 1.1 MΩ~10 MΩ :±300	1 Ω~10 MΩ	70°C	-55°C~+155°C
RC 1608	1/10						
RC 2012	1/8	150(V)	300(V)				
RC 3216	1/4						
RC 3225	1/3	200(V)	400(V)				
RC 5025	2/3						
RC 6432	1						

• Rated voltage (V) = √Rated power(W) × Nominal resistance value (Ω)
Rated voltage should be lower than (MAX) working voltage.

Power Derating Curve

The rated power is the maximum continuous loading power at 70 °C ambient temperature.
For ambient temperature above 70 °C, the loading power follows the below power derating curve.

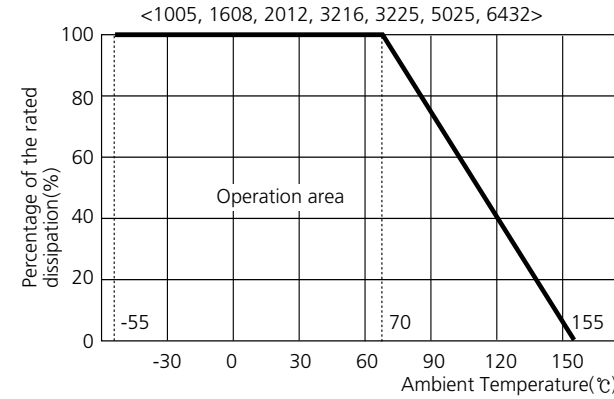

Marking

• 3 digits indication (E-24 series)	• 4 digits indication (E-96, E-192 series)
<ul style="list-style-type: none"> - Left 2 digits represent significant figures. - Last 1 digit represents exponential number of 10. - Example: 103 Left 2 digits: 10 Last 1 digit: 3 103 = 10 × 10³ Ω = 10000 Ω = 10kΩ 	<ul style="list-style-type: none"> - Left 3 digits represent significant figures. - Last 1 digit represents exponential number of 10. - Example: 1002 Left 3 digits: 100 Last 1 digit: 2 1002 = 100 × 10² Ω = 10000 Ω = 10kΩ
• 1005 type: No marking.	• 1005, 1608 type: No marking.

Significant Figure of Resistance Value

E192	E96	E24	E192	E96	E24	E192	E96	E24	E192	E96	E24	E192	E96	E24	E192	E96	E24	E192	E96	E24			
100	100	10	133	133		178	178		237	237		316	316		422	422		562	562	56	750	750	75
101			135			180		18	240		24	320			427			576			759		
102	102		137	137		182	182		243	243		324	324		432	432	43	576	576		768	768	
104			138			184			246			328			437			583			777		
105	105		140	140		187	187		249	249		332	332	33	442	442		590	590		787	787	
106			142			189			252			336			448			597			796		
107	107		143	143		191	191		255	255		340	340		453	453		604	604		806	806	
109			145			193			258			344			459			612			816		
110	110	11	147	147		196	196		261	261		348	348		464	464		619	619	62	825	825	82
111			149			198			264			352			470		47	626			835		
113	113		150	150	15	200	200	20	267	267		357	357		475	475		634	634		845	845	
114			152			203			271		27	361		36	481			642			856		
115	115		154	154		205	205		274	274		365	365		487	487		649	649		866	866	
117			156			208			277			370			493			657			876		
118	118		158	158		210	210		280	280		374	374		499	499		665	665		887	887	
120		12	160		16	213			284			379			505			673			898		
121	121		162	162		215	215		287	287		383	383		511	511	51	681	681	68	909	909	91
123			164			218			291			388			517			690			920		
124	124		165	165		221	221	22	294	294		392	392	39	523	523		698	698		931	931	
126			167			223			298			397			530			706			942		
127	127		169	169		226	226		301	301	30	402	402		536	536		715	715		953	953	
129			172			229			305			407			542			723			965		
130	130	13	174	174		232	232		309	309		412	412		549	549		732	732		976	976	
132			176			234			312			417			556			741			988		

The specifications and designs contained herein may be subject to change without notice. Please contact our sales representatives or product engineers before order.

- Operation Notes
- Example of land Pattern Design
- Recommended Soldering Conditions
- General Structure
- General
- Precision
- Jumper
- Low ohms (RUT Series)
- Ultra Low ohms (RU Series)
- Ultra Low Ohms (RUK Series)
- Ultra Low Ohms (RJ Series)
- Arrays (CONVEX Type)
- Arrays (CONCAVE Type)
- Arrays (FLAT Type)
- Anti-Sulfur Resistors
- Attenuator
- Characteristics Performance
- Packaging
- Standard Resistance Value

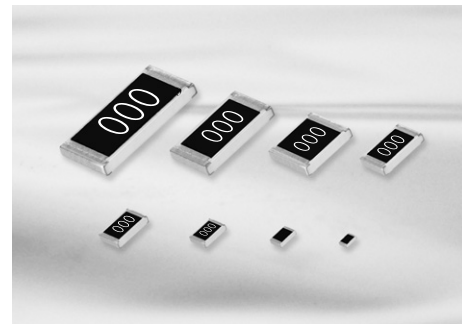

Feature

- Very small, thin, and light weight.
- Both flow and reflow soldering are applicable.
- Very low inductance.
- Suitable size and packaging for surface mount assembly.
- 100 % Lead-free product(Except RP series).

Application

- General purpose.
- Home Appliances.
(DVD, Digital TV, Digital Camera, Audio, Tunner).
- For Computers & Communications.
(Notebook, Memory Module, Mobile, Network Equipment, etc).

Structure and Dimensions

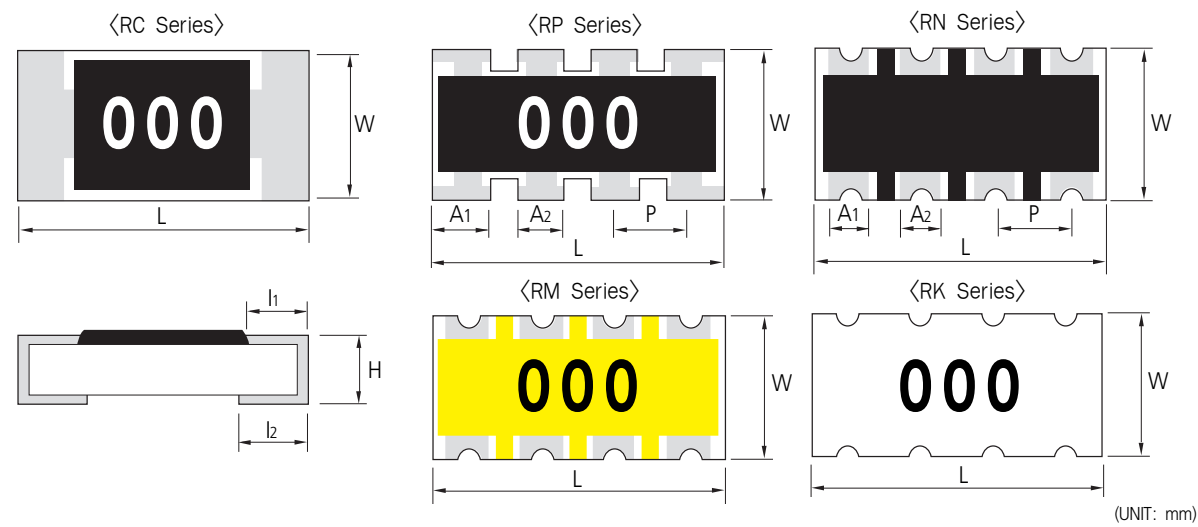

Type	Inch	L	W	H	A ₁	A ₂	I ₁	I ₂	P	Average Weight
RC0402	01005	0.40±0.02	0.20±0.02	0.13±0.02	-	-	0.10±0.03	0.10±0.03	-	0.04mg
RC0603	0201	0.60±0.03	0.30±0.03	0.23±0.03	-	-	0.10±0.05	0.15±0.05	-	0.15mg
RC1005	0402	1.00±0.05	0.50±0.05	0.35±0.05	-	-	0.20±0.10	0.25±0.10	-	0.6mg
RC1608	0603	1.60±0.10	0.80±0.10	0.45±0.10	-	-	0.30±0.20	0.35±0.10	-	2.1mg
RC2012	0805	2.00±0.15	1.25±0.15	0.50±0.10	-	-	0.40±0.20	0.35±0.20	-	4.9mg
RC3216	1206	3.20±0.15	1.60±0.15	0.55±0.10	-	-	0.45±0.20	0.40±0.20	-	9.5mg
RC3225	1210	3.20±0.20	2.55±0.20	0.55±0.10	-	-	0.45±0.20	0.40±0.20	-	16mg
RC5025	2010	5.00±0.20	2.50±0.20	0.55±0.10	-	-	0.60±0.20	0.60±0.20	-	26mg
RC6432	2512	6.30±0.20	3.20±0.20	0.55±0.10	-	-	0.60±0.20	0.60±0.20	-	41mg
RP102P	0402x2R	1.00±0.10	1.00±0.10	0.35±0.10	0.33±0.10	-	0.20±0.10	0.25±0.10	0.65±0.10	1.1mg
RP104P	0402x4R	2.00±0.10	1.00±0.10	0.35±0.10	0.40±0.15	0.30±0.15	0.15±0.10	0.25±0.10	0.50±0.15	2.2mg
RP164P	0603x4R	3.20±0.10	1.60±0.10	0.50±0.10	0.60±0.15	0.40±0.15	0.30±0.15	0.30±0.15	0.80±0.15	8.9mg
RN102P	0402x2R	1.00±0.10	1.00±0.10	0.35±0.10	0.30±0.10	-	0.15±0.10	0.25±0.15	0.50±0.10	1.2mg
RN104P	0402x4R	2.00±0.10	1.00±0.10	0.40±0.10	0.30±0.10	0.30±0.10	0.15±0.10	0.25±0.15	0.50±0.10	2.8mg
RM102P	0402x2R	1.00±0.10	1.00±0.10	0.35±0.10	0.30±0.10	-	0.15±0.10	0.25±0.15	0.50±0.10	1.2mg
RM104P	0402x4R	2.00±0.10	1.00±0.10	0.45±0.10	0.30±0.10	0.30±0.10	0.15±0.10	0.25±0.15	0.50±0.10	2.8mg
RK102P	0402x2R	1.00±0.10	1.00±0.10	0.35±0.10	0.30±0.10	-	-	0.25±0.15	0.50±0.10	1.2mg
RK104P	0402x4R	2.00±0.10	1.00±0.10	0.45±0.10	0.30±0.10	0.30±0.10	-	0.25±0.15	0.50±0.10	2.8mg
RF062P	0201x2R	0.80±0.05	0.60±0.05	0.23±0.10	0.20±0.10	-	0.10±0.10	0.20±0.10	0.50±0.05	0.3mg
RF064P	0201x4R	1.40±0.05	0.60±0.05	0.23±0.10	0.20±0.10	0.20±0.10	0.10±0.10	0.20±0.10	0.40±0.05	0.5mg
RM062P	0201x2R	0.80±0.05	0.60±0.05	0.23±0.10	0.20±0.10	-	0.10±0.10	0.20±0.10	0.50±0.05	0.3mg
RM064P	0201x4R	1.40±0.05	0.60±0.05	0.23±0.10	0.20±0.10	0.20±0.10	0.10±0.10	0.20±0.10	0.40±0.05	0.5mg

Parts Numbering System

• The part number system shall be in the following format

RC	2012	J	000	CS
Code Designation	Dimension & Size Code	Tolerance	Resistance Value	Packaging Code
RC : General	0402: 0.4×0.2(mm) - 01005(inch)			
RP : Convex Array	0603: 0.6×0.3(mm) - 0201(inch)			
RN : Concave Array	1005: 1.0×0.5(mm) - 0402(inch)			
RM : Inverted Array	1608: 1.6×0.8(mm) - 0603(inch)			
RK : Inverted Short-free Array	2012: 2.0×1.2(mm) - 0805(inch)			
RF : Flat Array	3216: 3.2×1.6(mm) - 1206(inch)			
	3225: 3.2×2.5(mm) - 1210(inch)	J : Max 50 mΩ	Jumper: 000	GS: Bulk Packing
	5025: 5.0×2.5(mm) - 2010(inch)			CS: Tape & Reel 7"
	6432: 6.4×3.2(mm) - 2512(inch)			ES: Tape & Reel 10"
	102P: 1.0×1.0(mm) - 0404(inch)			AS: Tape & Reel 13"
	104P: 2.0×1.0(mm) - 0804(inch)			
	164P: 3.2×1.6(mm) - 1206(inch)			

Jumper Resistors

Type	Resistance	Current Rating	Rated Ambient Temperature	Rated Working Temperature	Marking
RC0402	50mΩ max	0.5 (A)	70℃	-55℃ ~ +125℃	X
RC0603					X
RC1005					X
RC1608	50mΩ max	2.0 (A)	70℃	-55℃ ~ +155℃	O
RC2012					
RC3216					
RC3225					
RC5025					
RC6432					
RP102P	50mΩ max	1.0 (A)	70℃	-55℃ ~ +155℃	X
RP104P					O
RP164P					O
RN102P	50mΩ max	1.0 (A)	70℃	-55℃ ~ +155℃	X
RN104P					X
RM102P	50mΩ max	1.0 (A)	70℃	-55℃ ~ +155℃	X
RM104P					O
RK102P	50mΩ max	1.0 (A)	70℃	-55℃ ~ +155℃	X
RK104P					O
RF062P	50mΩ max	0.5 (A)	70℃	-55℃ ~ +125℃	X
RF064P					
RM062P					
RM064P	50mΩ max	0.5 (A)	70℃	-55℃ ~ +125℃	X

Power Derating Curve

The rated power is the maximum continuous loading power at 70℃ ambient temperature. For ambient temperature above 70℃, the loading power follows the below power derating curve. (The load current shall be derated according to derating curve in case of the 'Jumper')

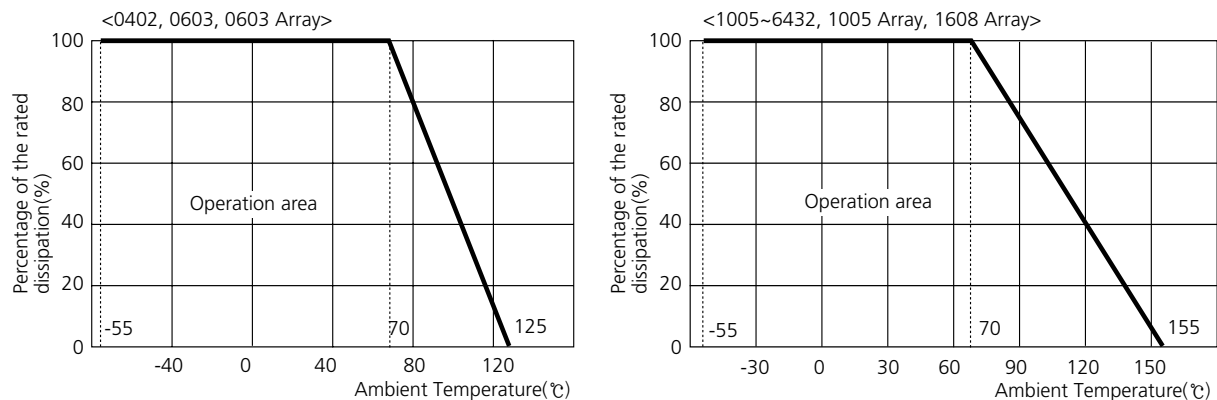

The specifications and designs contained herein may be subject to change without notice. Please contact our sales representatives or product engineers before order.

- Operation Notes
- Example of land Pattern Design
- Recommended Soldering Conditions
- General Structure
- General
- Precision
- Jumper
- Low ohms (RUT Series)
- Ultra Low ohms (RU Series)
- Ultra Low Ohms (RUK Series)
- Ultra Low Ohms (RJ Series)
- Arrays (CONVEX Type)
- Arrays (CONCAVE Type)
- Arrays (FLAT Type)
- Anti-Sulfur Resistors
- Attenuator
- Characteristics Performance
- Packaging
- Standard Resistance Value

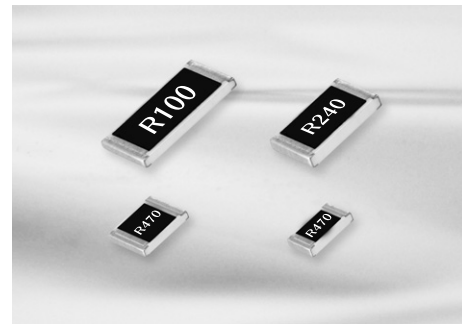

Feature

- Under 1 ohms, precision resistance.
- Both flow and reflow soldering are applicable.
- High Power with Low TCR.
- 100% Lead Free Products (PbO not used).
- RoHS Compliant.

Application

- Current Sensing.
- PCM of Battery Pack.
- Power supplying part, DC power charger, adapter.
- Mobile Phone, HDD, DSC, LCD.

Structure and Dimensions

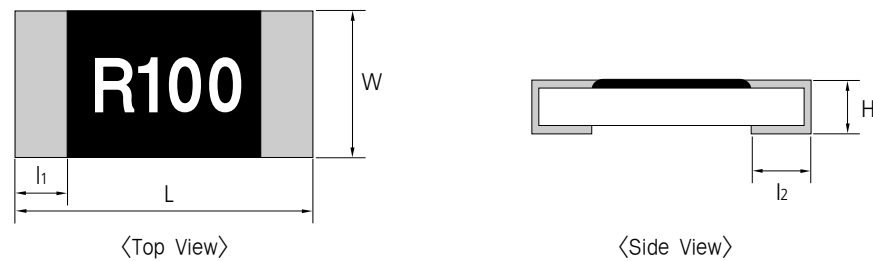

(UNIT: mm)

Type	Inch	L	W	H	l ₁	l ₂	Average Weight
RUT1005	0402	1.00±0.05	0.50±0.05	0.35±0.05	0.20±0.10	0.25±0.10	0.6mg
RUT1608	0603	1.60±0.10	0.80±0.10	0.45±0.10	0.30±0.20	0.35±0.10	2.1mg
RUT2012	0805	2.00±0.15	1.25±0.15	0.50±0.10	0.40±0.20	0.35±0.20	4.9mg
RUT3216	1206	3.20±0.15	1.60±0.15	0.55±0.10	0.45±0.20	0.40±0.20	9.5mg
RUT3225	1210	3.20±0.20	2.55±0.20	0.55±0.10	0.45±0.20	0.40±0.20	16mg
RUT5025	2010	5.00±0.20	2.50±0.20	0.55±0.10	0.60±0.20	0.60±0.20	26mg
RUT6432	2512	6.30±0.20	3.20±0.20	0.55±0.10	0.60±0.20	0.60±0.20	41mg

Parts Numbering System

• The part number system shall be in the following format

RUT	2012	J	R100	CS
Code Designation	Dimension & Size Code	Tolerance	Resistance Value	Packaging Code
RUT: Current Sensing Resistor Top Mounting (Face-up)	1005: 1.0 × 0.5(mm) - 0402(inch) 1608: 1.6 × 0.8(mm) - 0603(inch) 2012: 2.0 × 1.2(mm) - 0805(inch) 3216: 3.2 × 1.6(mm) - 1206(inch) 3225: 3.2 × 2.5(mm) - 1210(inch) 5025: 5.0 × 2.5(mm) - 2010(inch) 6432: 6.4 × 3.2(mm) - 2512(inch)	F: ±1% G: ±2% J: ±5%	4-digit coding system	CS: Tape & Reel 7" ES: Tape & Reel 10" AS: Tape & Reel 13"

Specification

Type	Power Rating (W)	Working Current (A, MAX)	TCR (ppm/°C)	Resistance Range (Ω)	Rated Ambient Temperature	Rated Working Temperature
RUT1005	1/10 (0.1)	$\sqrt{P/R}$	±150	0.1~0.98	70°C	-55~+155°C
RUT1608	1/8 (0.125)					
RUT2012	1/4 (0.25)					
RUT3216	1/3 (0.33)					
RUT3225	1/2 (0.50)					
RUT5025	2/3 (0.66)					
RUT6432	1 (1.0)					

- Rated Current (A) = $\sqrt{\text{Rated power(W)}/\text{Nominal resistance value } (\Omega)}$
Rated Current should be lower than (MAX) working Current.

Power Derating Curve

The rated power is the maximum continuous loading power at 70°C ambient temperature. For ambient temperature above 70°C, the loading power follows the below power derating curve.

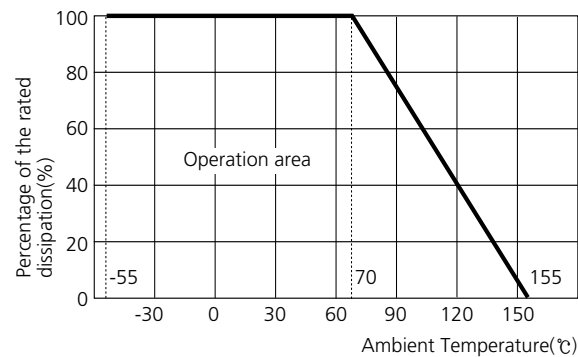

Marking

4 digits indication

- R means decimal point.
- Other digits represent the significant value.
- Example : R100
R100 = .100 = 0.100 Ω
= 0.1 Ω or 100 mΩ



Resistance Value Table

Code	Value (Ω)	Tol (%)	Code	Value (Ω)	Tol (%)	Code	Value (Ω)	Tol (%)	Code	Value (Ω)	Tol (%)	Code	Value (Ω)	Tol (%)	Code	Value (Ω)	Tol (%)
R100	0.1	±1, ±5	R154	0.154	±1	R226	0.226	±1	R330	0.33	±1, ±5	R470	0.47	±1, ±5	R680	0.68	±1, ±5
R102	0.102	±1	R158	0.158	±1	R232	0.232	±1	R332	0.332	±1	R475	0.475	±1	R681	0.681	±1
R105	0.105	±1	R160	0.16	±1, ±5	R237	0.237	±1	R340	0.34	±1	R487	0.487	±1	R698	0.698	±1
R107	0.107	±1	R162	0.162	±1	R240	0.24	±1, ±5	R348	0.348	±1	R499	0.499	±1	R715	0.715	±1
R110	0.11	±1, ±5	R165	0.165	±1	R243	0.243	±1	R357	0.357	±1	R510	0.51	±1, ±5	R732	0.732	±1
R113	0.113	±1	R169	0.169	±1	R249	0.249	±1	R360	0.36	±1, ±5	R511	0.511	±1	R750	0.75	±1, ±5
R115	0.115	±1	R174	0.174	±1	R255	0.255	±1	R365	0.365	±1	R523	0.523	±1	R768	0.768	±1
R118	0.118	±1	R178	0.178	±1	R261	0.261	±1	R374	0.374	±1	R536	0.536	±1	R787	0.787	±1
R120	0.12	±1, ±5	R180	0.180	±1, ±5	R267	0.267	±1	R383	0.383	±1	R549	0.549	±1	R806	0.806	±1
R121	0.121	±1	R182	0.182	±1	R270	0.27	±1, ±5	R390	0.39	±1, ±5	R560	0.56	±1, ±5	R820	0.82	±1, ±5
R124	0.124	±1	R187	0.187	±1	R274	0.274	±1	R392	0.392	±1	R562	0.562	±1	R825	0.825	±1
R127	0.127	±1	R191	0.191	±1	R280	0.28	±1	R402	0.402	±1	R576	0.576	±1	R845	0.845	±1
R130	0.13	±1, ±5	R196	0.196	±1	R287	0.287	±1	R412	0.412	±1	R590	0.59	±1	R866	0.866	±1
R133	0.133	±1	R200	0.200	±1, ±5	R294	0.294	±1	R422	0.422	±1	R604	0.604	±1	R887	0.887	±1
R137	0.137	±1	R205	0.205	±1	R300	0.3	±1, ±5	R430	0.43	±1, ±5	R619	0.619	±1	R909	0.909	±1
R140	0.14	±1	R210	0.21	±1	R301	0.301	±1	R432	0.432	±1	R620	0.62	±1, ±5	R910	0.91	±1, ±5
R143	0.143	±1	R215	0.215	±1	R309	0.309	±1	R442	0.442	±1	R634	0.634	±1	R931	0.931	±1
R147	0.147	±1	R220	0.22	±1, ±5	R316	0.316	±1	R453	0.453	±1	R649	0.649	±1	R953	0.953	±1
R150	0.15	±1, ±5	R221	0.221	±1	R324	0.324	±1	R464	0.464	±1	R665	0.665	±1	R976	0.976	±1

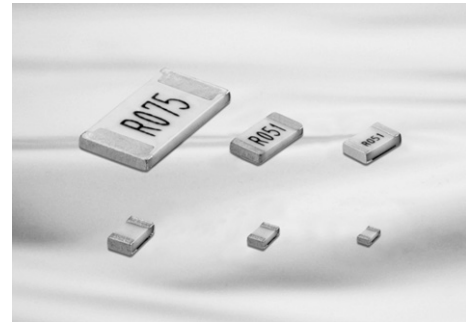

Feature

- Thick Film Type Ultra Low Ohm Resistor.
- High Precision Reliability.
- High Power with Low TCR.
- 100% Lead Free Products (PbO not used).
- RoHS Compliant.

Application

- Current Sensing.
- PCM of Battery Pack.
- Power supplying part, DC power charger, adapter.
- Mobile Phone, Mobile PC, Note PC, HDD, DSC, LCD.

Structure and Dimensions

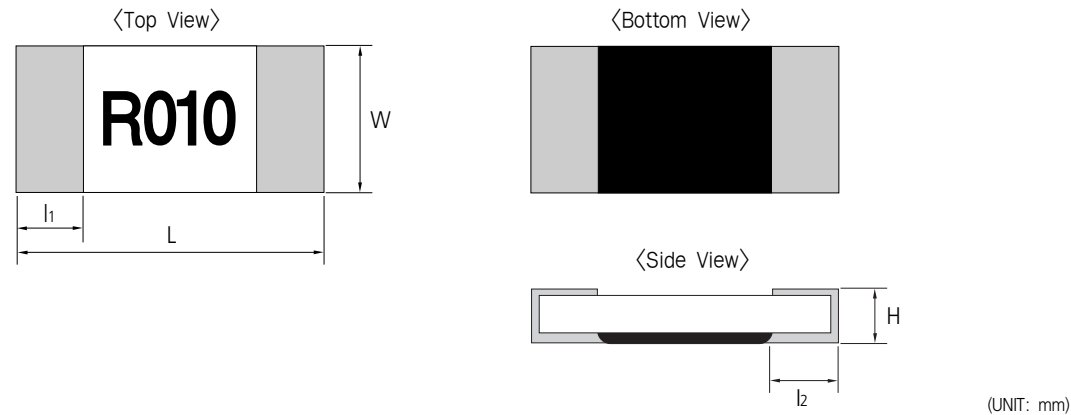

Type	Inch	L	W	H	l ₁	l ₂	Average Weight
RU1005	0402	1.00±0.05	0.50±0.05	0.35±0.05	0.25±0.15	0.25±0.15	0.6mg
RU1608	0603	1.60±0.10	0.80±0.10	0.45±0.10	0.30±0.20	R ≤ 0.05: 0.50±0.20 R > 0.05: 0.35±0.20	2.2mg
RU2012	0805	2.00±0.15	1.25±0.15	0.55±0.10	0.40±0.20	R ≤ 0.05: 0.65±0.20 R > 0.05: 0.40±0.20	4.7mg
RU3216	1206	3.20±0.15	1.60±0.15	0.60±0.10	0.45±0.20	R ≤ 0.05: 0.90±0.20 R > 0.05: 0.60±0.20	9.4mg
RU3225	1210	3.20±0.20	2.55±0.20	0.55±0.10	0.45±0.20	R ≤ 0.05: 1.2±0.20 R > 0.05: 0.75±0.20	9.5mg
RU5025	2010	5.00±0.20	2.50±0.20	0.60±0.10	0.80±0.20	R ≤ 0.05: 1.5±0.20 R > 0.05: 0.90±0.20	27mg
RU6432	2512	6.30±0.20	3.20±0.20	0.60±0.10	1.00±0.20	R ≤ 0.05: 1.90±0.20 R > 0.05: 1.10±0.25	42mg

Parts Numbering System

• The part number system shall be in the following format

RU	2012	F	R051	CS
Code Designation	Dimension & Size Code	Tolerance	Resistance Value	Packaging Code
	1005: 1.0 × 0.5(mm) - 0402(inch)			
	1608: 1.6 × 0.8(mm) - 0603(inch)			
	2012: 2.0 × 1.2(mm) - 0805(inch)	F: ±1%		CS: Tape & Reel 7"
	3216: 3.2 × 1.6(mm) - 1206(inch)	G: ±2%	4-digit coding system	ES: Tape & Reel 10"
	3225: 3.2 × 2.5(mm) - 1210(inch)	J: ±5%		AS: Tape & Reel 13"
	5025: 5.0 × 2.5(mm) - 2010(inch)			
	6432: 6.4 × 3.2(mm) - 2512(inch)			

Specification

Type	Power Rating (W)	Rated Current (A)	Resistance Range (Ω)	T.C.R (ppm/°C)	Rated Ambient Temperature	Rated Working Temperature
RU1005	1/8 (0.125)	$\sqrt{P/R}$	25m~100m	R < 47m: ±500 R ≥ 47m: ±150	70°C	-55°C~+155°C
RU1608	1/4 (0.25)			10m~100m		
RU2012	1/3 (0.33)		R ≤ 25m: ±500 R < 33m: ±350 R ≥ 33m: ±150			
RU3216	1/2 (0.5)					
RU3225	2/3 (0.66)					
RU5025	3/4 (0.75)					
RU6432	1 (1)					

• Rated Current (A) = $\sqrt{\text{Rated Power(W)} / \text{Nominal Resistance Value(Ω)}}$
Please contact our sales representatives or product engineers for lower T.C.R or higher rated power products.

Power Derating Curve

The rated power is the maximum continuous loading power at 70°C ambient temperature. For ambient temperature above 70°C, the loading power follows the below power derating curve.

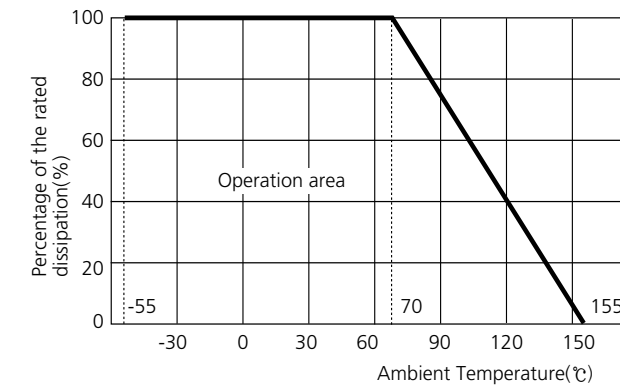

Marking

4-digit Coding System

- R means decimal point.
- Other digits represent the significant value.
- Example : R010
R010 = .010 = 0.010 Ω
= 0.01 Ω or 10 mΩ



Resistance Value Table

Code	Value (Ω)	Tol (%)	Code	Value (Ω)	Tol (%)	Code	Value (Ω)	Tol (%)	Code	Value (Ω)	Tol (%)
R010	0.01	±1, ±5	R020	0.02	±1, ±5	R039	0.039	±1, ±5	R062	0.062	±1, ±5
R011	0.011	±1, ±5	R022	0.022	±1, ±5	R040	0.04	±1, ±5	R068	0.068	±1, ±5
R012	0.012	±1, ±5	R024	0.024	±1, ±5	R043	0.043	±1, ±5	R075	0.075	±1, ±5
R013	0.013	±1, ±5	R027	0.027	±1, ±5	R047	0.047	±1, ±5	R082	0.082	±1, ±5
R015	0.015	±1, ±5	R030	0.03	±1, ±5	R050	0.05	±1, ±5	R091	0.091	±1, ±5
R016	0.016	±1, ±5	R033	0.033	±1, ±5	R051	0.051	±1, ±5	R100	0.1	±1, ±5
R018	0.018	±1, ±5	R036	0.036	±1, ±5	R056	0.056	±1, ±5			

The specifications and designs contained herein may be subject to change without notice. Please contact our sales representatives or product engineers before order.

- Operation Notes
- Example of land Pattern Design
- Recommended Soldering Conditions
- General Structure
- General
- Precision
- Jumper
- Low ohms (RUT Series)
- Ultra Low ohms (RU Series)
- Ultra Low Ohms (RUK Series)
- Ultra Low Ohms (RJ Series)
- Arrays (CONVEX Type)
- Arrays (CONCAVE Type)
- Arrays (FLAT Type)
- Anti-Sulfur Resistors
- Attenuator
- Characteristics Performance
- Packaging
- Standard Resistance Value

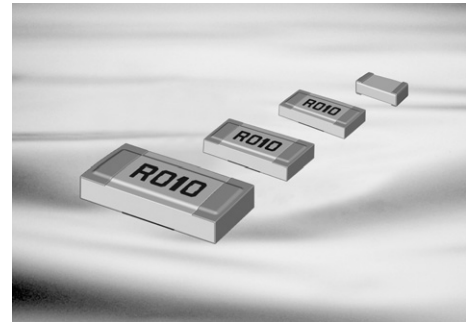

Feature

- Thick Film Type Ultra Low Ohm Resistor.
- High Precision Reliability.
- High Power with Very Low TCR.
- 100% Lead Free Products (PbO not used).
- RoHS Compliant.

Application

- Current Sensing.
- PCM of Battery Pack.
- Power supplying part, DC power charger, adapter.
- Mobile Phone, Mobile PC, Note PC, HDD, DSC, LCD.

Structure and Dimensions

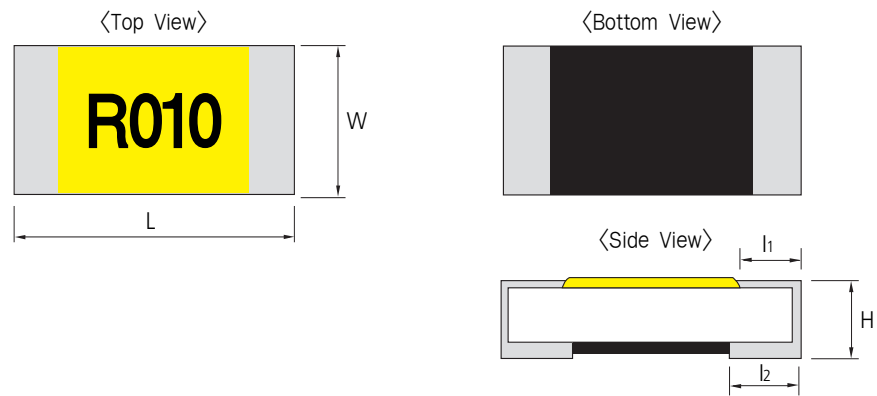

Type	Inch	L	W	H	l ₁	l ₂	Average Weight
RUK1608	0603	1.60±0.10	0.80±0.10	0.45±0.10	0.35±0.20	0.50±0.20	2.2mg
RUK2012	0805	2.00±0.15	1.25±0.15	0.55±0.10	0.40±0.20	0.55±0.20	4.7mg
RUK3216	1206	3.20±0.15	1.60±0.15	0.65±0.10	0.45±0.20	0.90±0.20	9.4mg
RUK3225	1210	3.20±0.20	2.55±0.20	0.60±0.10	0.45±0.20	0.90±0.20	9.5mg
RUK5025	2010	5.00±0.20	2.50±0.20	0.65±0.10	0.80±0.20	1.10±0.20	27mg
RUK6432	2512	6.30±0.20	3.20±0.20	0.65±0.10	1.0±0.20	1.90±0.20	42mg

Parts Numbering System

• The part number system shall be in the following format

RUK	1608	F	R010	CS
Code Designation	Dimension & Size Code	Tolerance	Resistance Value	Packaging Code

RUK : Current Sensing Resistor Low TCR	1608: 1.6 × 0.8(mm) - 0603(inch) 2012: 2.0 × 1.2(mm) - 0805(inch) 3216: 3.2 × 1.6(mm) - 1206(inch) 3225: 3.2 × 2.5(mm) - 1210(inch) 5025: 5.0 × 2.5(mm) - 2010(inch) 6432: 6.4 × 3.2(mm) - 2512(inch)	F: ±1% G: ±2% J: ±5%	4-digits coding system	CS: Tape & Reel 7" ES: Tape & Reel 10" AS: Tape & Reel 13"
--	--	----------------------------	------------------------	--

Specification

Type	Power Rating (W)	Rated Current (A)	Resistance Range (Ω)	T.C.R (ppm/°C)	Rated Ambient Temperature	Rated Working Temperature
RUK1608	1/2 (0.5)	$\sqrt{P/R}$	10m~30m	±100	70°C	-55°C~+155°C
RUK2012	1/2 (0.50)					
RUK3216	1 (1.0)					
RUK3225	1 (1.0)					
RUK5025	1 (1.0)					
RUK6432	1 (1.0)					

• Rated Current (A) = $\sqrt{\text{Rated Power(W)} / \text{Nominal Resistance Value}(\Omega)}$
 Please contact our sales representatives or product engineers for lower T.C.R or higher rated power products.

Power Derating Curve

The rated power is the maximum continuous loading power at 70°C ambient temperature. For ambient temperature above 70°C, the loading power follows the below power derating curve.

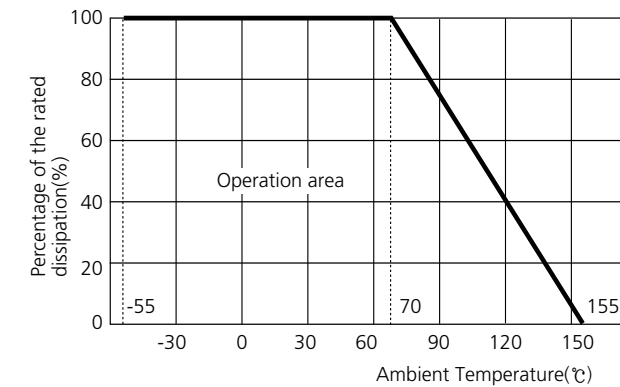

Marking

4-digits coding system

- R means decimal point.
- Other digits represent significant value.
- Example : R010
 R010 = .010 = 0.010Ω
 = 0.01Ω or 10 mΩ



Resistance Value Table

Code	Value (Ω)	Tol (%)	Code	Value (Ω)	Tol (%)	Code	Value (Ω)	Tol (%)	Code	Value (Ω)	Tol (%)
R010	0.01	±1, ±5	R020	0.02	±1, ±5	R039	0.039	±1, ±5	R060	0.06	±1, ±5
R011	0.011	±1, ±5	R022	0.022	±1, ±5	R040	0.04	±1, ±5	R062	0.062	±1, ±5
R012	0.012	±1, ±5	R024	0.024	±1, ±5	R043	0.043	±1, ±5	R068	0.068	±1, ±5
R013	0.013	±1, ±5	R027	0.027	±1, ±5	R047	0.047	±1, ±5	R075	0.075	±1, ±5
R015	0.015	±1, ±5	R030	0.03	±1, ±5	R050	0.05	±1, ±5	R082	0.082	±1, ±5
R016	0.016	±1, ±5	R033	0.033	±1, ±5	R051	0.051	±1, ±5	R091	0.091	±1, ±5
R018	0.018	±1, ±5	R036	0.036	±1, ±5	R056	0.056	±1, ±5	R100	0.1	±1, ±5

The specifications and designs contained herein may be subject to change without notice. Please contact our sales representatives or product engineers before order.

- Operation Notes
- Example of land Pattern Design
- Recommended Soldering Conditions
- General Structure
- General
- Precision
- Jumper
- Low ohms (RUT Series)
- Ultra Low ohms (RU Series)
- Ultra Low Ohms (RUK Series)
- Ultra Low Ohms (RJ Series)
- Arrays (CONVEX Type)
- Arrays (CONCAVE Type)
- Arrays (FLAT Type)
- Anti-Sulfur Resistors
- Attenuator
- Characteristics Performance
- Packaging
- Standard Resistance Value

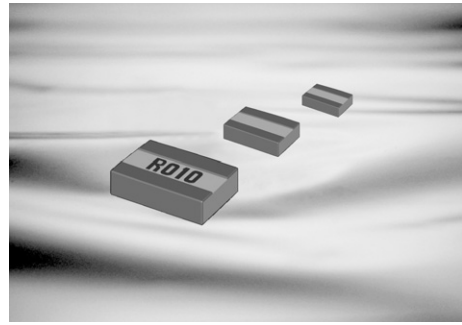

Feature

- Thick Film Wide Terminal Type.
- High Precision Reliability.
- High Power with Low TCR.
- 100% Lead Free Products (PbO not used).
- RoHS Compliant.

Application

- Current Sensing.
- PCM of Battery Pack.
- DC Power Charger, Adapter.
- Mobile Phone, Mobile PC, HDD, DSC, LCD.

Structure and Dimensions

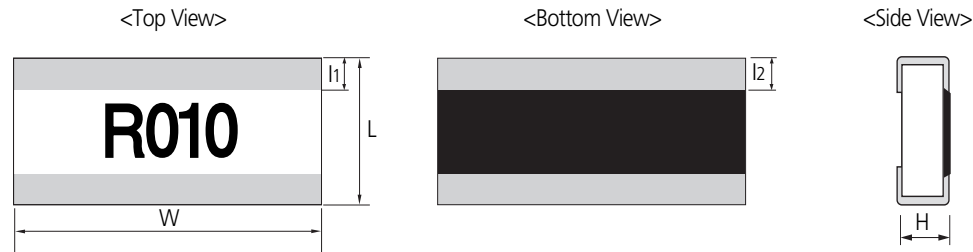

(UNIT: mm)

Type	Inch	L	W	H	l ₁	l ₂	Average Weight
RJ0816	0306	0.80±0.10	1.60±0.10	0.45±0.15	0.25±0.15	0.30±0.15	2.3mg
RJ1220	0508	1.25±0.10	2.00±0.10	0.55±0.15	0.30±0.15	0.35±0.15	5mg
RJ1632	0612	1.60±0.15	3.20±0.15	0.55±0.15	0.35±0.20	0.40±0.20	10mg
RJ2037	0815	2.00±0.15	3.75±0.15	0.55±0.15	0.45±0.20	0.55±0.20	15mg
RJ3264	1225	3.20±0.20	6.40±0.20	0.55±0.15	0.60±0.20	0.60±0.20	40mg

Parts Numbering System

• The part number system shall be in the following format

RUK	1608	F	R010	CS
Code Designation	Dimension & Size Code	Tolerance	Resistance Value	Packaging Code
RJ : Thick Film	0816 : 0.8 × 1.6(mm) - 0306(inch)	F: ±1%	4-digits coding system	CS: Tape & Reel 7"
Wide Terminal	1220 : 1.2 × 2.0(mm) - 0508(inch)	G: ±2%		ES: Tape & Reel 10"
CSR	2037 : 2.0 × 3.7(mm) - 0815(inch)	J: ±5%		AS: Tape & Reel 13"
	3264 : 3.2 × 6.4(mm) - 1225(inch)			

Specification

Type	Power Rating (W)	Rated Current (A)	Resistance Range (Ω)	T.C.R (ppm/°C)	Rated Ambient Temperature	Rated Working Temperature
RJ0618(0306)	1/2 (0.5)	$\sqrt{P/R}$	0.005~0.1 (5m~100m)	±100	70°C	-55°C~+155°C
RJ1220(0508)	1					
RJ1632(0612)	1					
RJ2037(0815)	1					
RJ3264(1225)	2					

• Rated Current (A) = $\sqrt{\text{Rated Power(W)} / \text{Nominal Resistance Value(}\Omega)}$
Please contact our sales representatives or production engineer for lower T.C.R or higher rated power products.

Power Derating Curve

The rated power is the maximum continuous loading power at 70°C ambient temperature. For ambient temperature above 70°C, the loading power follows the below power derating curve.

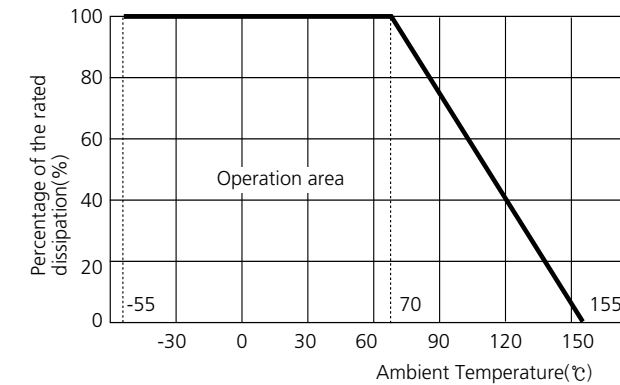

Marking

4-digits coding system

- R means decimal point.
- Other digits represent significant value.
- Example : R010
R010 = .010 = 0.010Ω
= 0.01Ω or 10 mΩ



Resistance Value Table

Code	Value (Ω)	Tol (%)	Code	Value (Ω)	Tol (%)	Code	Value (Ω)	Tol (%)	Code	Value (Ω)	Tol (%)
R005	0.005	±1, ±5	R013	0.013	±1, ±5	R030	0.03	±1, ±5	R051	0.051	±1, ±5
R006	0.006	±1, ±5	R015	0.015	±1, ±5	R033	0.033	±1, ±5	R056	0.056	±1, ±5
R007	0.007	±1, ±5	R016	0.016	±1, ±5	R036	0.036	±1, ±5	R062	0.062	±1, ±5
R008	0.008	±1, ±5	R018	0.018	±1, ±5	R039	0.039	±1, ±5	R068	0.068	±1, ±5
R009	0.009	±1, ±5	R020	0.02	±1, ±5	R040	0.04	±1, ±5	R075	0.075	±1, ±5
R010	0.01	±1, ±5	R022	0.022	±1, ±5	R043	0.043	±1, ±5	R082	0.082	±1, ±5
R011	0.011	±1, ±5	R024	0.024	±1, ±5	R047	0.047	±1, ±5	R091	0.091	±1, ±5
R012	0.012	±1, ±5	R027	0.027	±1, ±5	R050	0.05	±1, ±5	R100	0.1	±1, ±5

The specifications and designs contained herein may be subject to change without notice. Please contact our sales representatives or product engineers before order.

- Operation Notes
- Example of land Pattern Design
- Recommended Soldering Conditions
- General Structure
- General
- Precision
- Jumper
- Low ohms (RUT Series)
- Ultra Low ohms (RU Series)
- Ultra Low Ohms (RUK Series)
- Ultra Low Ohms (RJ Series)
- Arrays (CONVEX Type)
- Arrays (CONCAVE Type)
- Arrays (FLAT Type)
- Anti-Sulfur Resistors
- Attenuator
- Characteristics Performance
- Packaging
- Standard Resistance Value

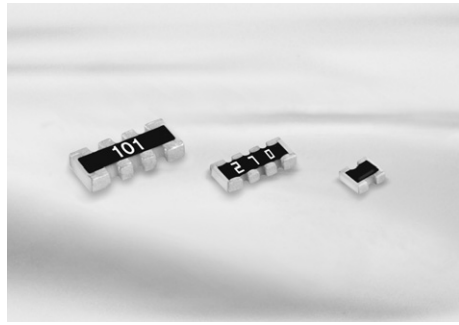

Feature

- Reducing SMD surface area (40% reduced).
- Reducing SMD costs (75% reduced).
- Both flow and reflow soldering are applicable.

The product of lead-free terminal is RoHS compliant. PbO(lead oxide) is included in the glass of our product which is prescribed on RoHS appendix as an exception.

Application

- For semiconductor devices.
- For computers, digital circuits.

Structure and Dimensions

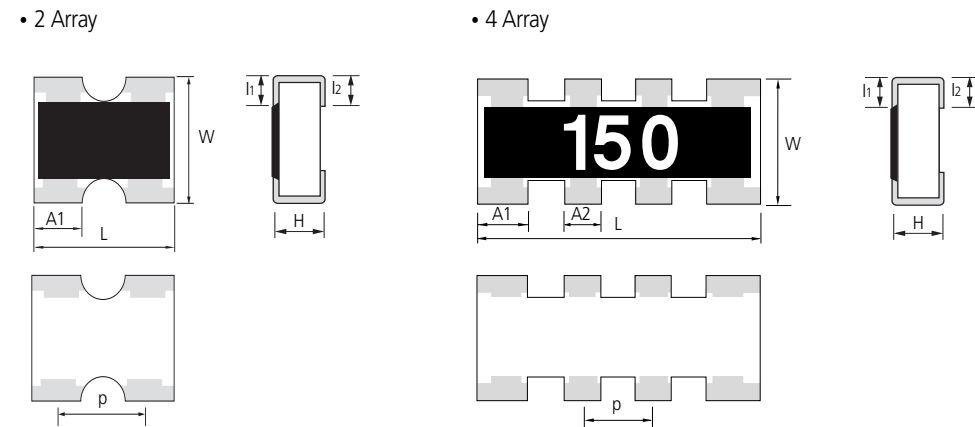

(UNIT: mm)

Type	L	W	H	A1	A2	l1	l2	P	Average Weight
RP102P	1.00±0.10	1.00±0.10	0.35±0.10	0.33±0.10	-	0.20±0.10	0.25±0.10	0.65±0.10	1.1mg
RP104P	2.00±0.10	1.00±0.10	0.35±0.10	0.30±0.15	0.40±0.15	0.15±0.10	0.25±0.15	0.50±0.15	2.2mg
RP164P	3.20±0.10	1.60±0.10	0.50±0.10	0.40±0.15	0.60±0.15	0.30±0.15	0.30±0.15	0.80±0.15	8.9mg

Parts Numbering System

• The part number system shall be in the following format

RP	10	4P	J	100	CS
Code Designation	Dimension	Resistors	Tolerance	Resistance Value	Packaging Code
RP: Convex type array	10 : 1005 16 : 1608	2P: 2 Pieces 4P: 4 Pieces	J: ±5%	3 digit coding system (IEC coding system) E-24 series	CS : Tape Packaging 7" ES : Tape Packaging 10" AS : Tape Packaging 13"

Specification

Type	Power Rating (W)	Working Voltage (MAX)	Overload Voltage (MAX)	TCR (ppm/°C)	Resistance Range (Ω)	Rated Ambient Temperature	Rated Working Temperature
102P	1/16	25(V)	50(V)	1 Ω ~ 99 Ω : ±300 10 Ω ~ 1 MΩ : ±200	1 Ω ~ 1MΩ	70°C	-55°C ~ +155°C
104P		25(V)	50(V)				
164P		50(V)	100(V)				

• Rated voltage (V) = $\sqrt{\text{Rated power(W)} \times \text{Nominal resistance value } (\Omega)}$
Rated voltage should be lower than (MAX) working voltage.

Power Derating Curve

The rated power is the maximum continuous loading power at 70°C ambient temperature. For ambient temperature above 70°C, the loading power follows the below power derating curve.

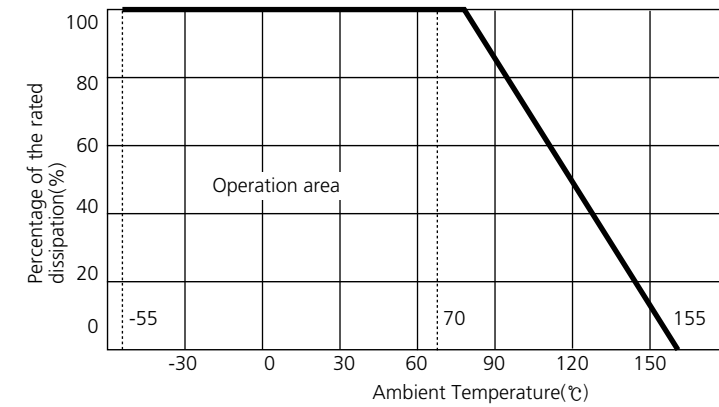

Marking

- 3 digits indication(E-24 series)
 - Left 2 digits represent significant figures.
 - Last 1 digit represents exponential number of 10.
 - Example: 103
 - Left 2 digits: 10
 - Last 1 digit: 3
 - $103 = 10 \times 10^3 = 10000 \Omega = 10k\Omega$
- RP102P: No marking.

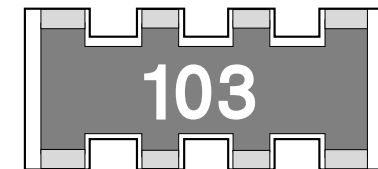

Land Pattern

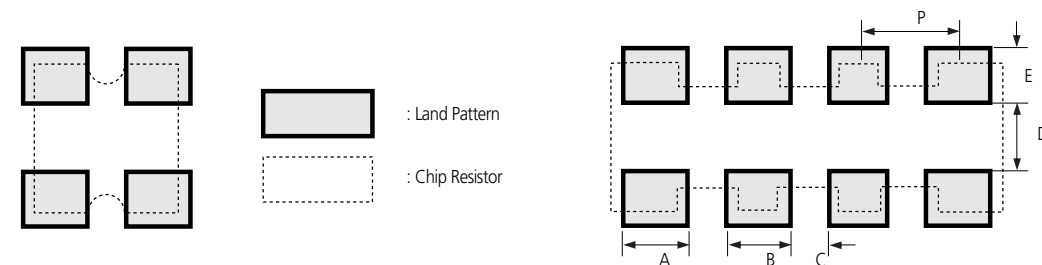

Type	A	B	C	D	E	P1	P2
10AT	0.4	0.4	0.25	0.5	0.5	0.65	-
102P	0.4	0.4	0.25	0.5	0.5	0.65	-
104P	0.7	0.3	0.2	0.5	0.5	0.55	0.5
164P	0.7	0.5	0.3	0.9	0.8	0.9	0.8

The specifications and designs contained herein may be subject to change without notice. Please contact our sales representatives or product engineers before order.

- Operation Notes
- Example of land Pattern Design
- Recommended Soldering Conditions
- General Structure
- General
- Precision
- Jumper
- Low ohms (RUT Series)
- Ultra Low ohms (RU Series)
- Ultra Low Ohms (RUK Series)
- Ultra Low Ohms (RJ Series)
- Arrays (CONVEX Type)
- Arrays (CONCAVE Type)
- Arrays (FLAT Type)
- Anti-Sulfur Resistors
- Attenuator
- Characteristics Performance
- Packaging
- Standard Resistance Value

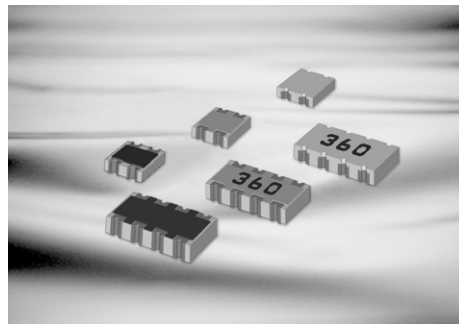

Feature

- Strong Body.
- Both flow and reflow soldering are applicable.
- Concave Type Terminal.

The product of lead-free terminal is RoHS compliant. PbO(lead oxide) is included in the glass of our product which is prescribed on RoHS appendix as an exception.

Application

- For semiconductor devices.
- For computers, digital circuits.

Structure and Dimensions

(1) Reverse Concave Type

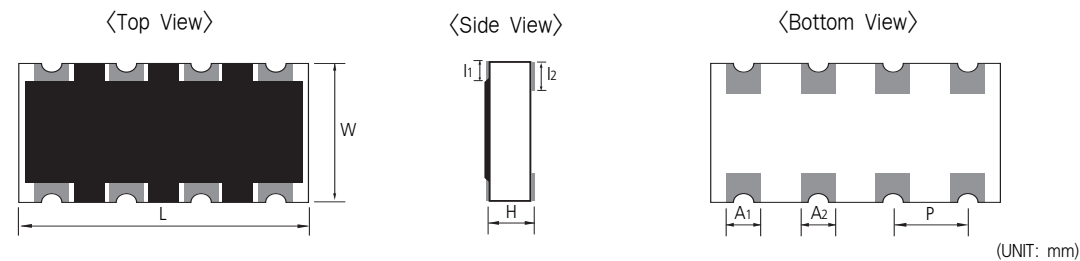

(UNIT: mm)

Type	Inch	L	W	H	A1	A2	l1	l2	P	Average Weight
RN102P	0402x2R	1.00±0.10	1.00±0.10	0.35±0.10	0.30±0.10	-	0.15±0.10	0.25±0.15	0.50±0.10	1.2mg
RN104P	0402x4R	2.00±0.10	1.00±0.10	0.40±0.10	0.30±0.10	0.30±0.10	0.15±0.10	0.25±0.15	0.50±0.10	2.8mg

(2) Inverted Concave Type

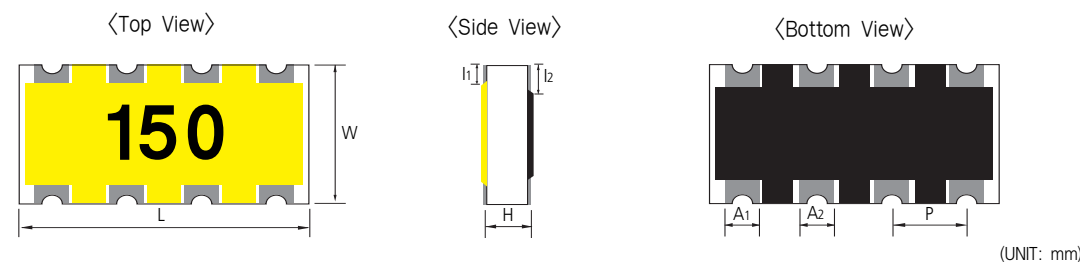

(UNIT: mm)

Type	Inch	L	W	H	A1	A2	l1	l2	P	Average Weight
RM102P	0402x2R	1.00±0.10	1.00±0.10	0.35±0.10	0.30±0.10	-	0.15±0.10	0.25±0.15	0.50±0.10	1.2mg
RM104P	0402x4R	2.00±0.10	1.00±0.10	0.40±0.10	0.30±0.10	0.30±0.10	0.15±0.10	0.25±0.15	0.50±0.10	2.8mg

(3) Short-free & Inverted Concave Type

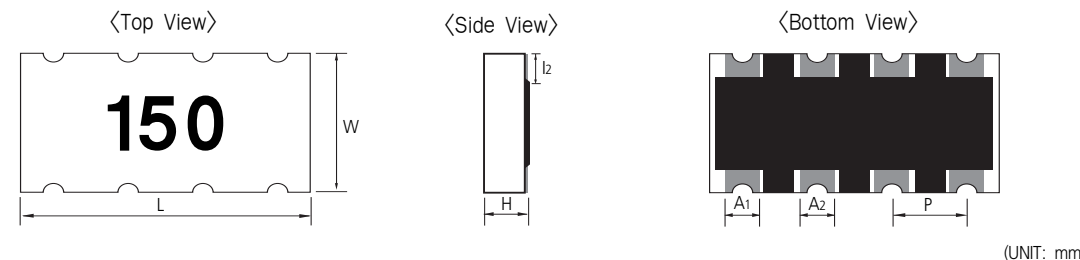

(UNIT: mm)

Type	Inch	L	W	H	A1	A2	l1	l2	P	Average Weight
RK102P	0402x2R	1.00±0.10	1.00±0.10	0.35±0.10	0.30±0.10	-	-	0.25±0.15	0.50±0.10	1.2mg
RK104P	0402x4R	2.00±0.10	1.00±0.10	0.40±0.10	0.30±0.10	0.30±0.10	-	0.25±0.15	0.50±0.10	2.8mg

Parts Numbering System

- The part number system shall be in the following format

RN	10	4P	J	100	CS
Code Designation	Dimension	Resistors	Tolerance	Resistance Value	Packaging Code
RN : Concave Type Array RM : Inverted Type Array RK : Short Free & Inverted Type	10: 1005	2P: 2 Pieces 4P: 4 Pieces	F: ±1% J: ±5%	3 digit coding system (IEC coding system) E-24 series	CS : Tape Packaging 7" ES : Tape Packaging 10" AS : Tape Packaging 13"

Specification

Type	Power Rating (W)	Working Voltage (MAX)	Overload Voltage (MAX)	TCR (ppm/°C)	Resistance Range (Ω)	Rated Ambient Temperature	Rated Working Temperature
102P	1/16	25(V)	50(V)	1~9.9 Ω: ±300	1 Ω~1M Ω	70°C	-55°C~+155°C
104P		25(V)	50(V)	10 Ω~1M Ω: ±200			

- Rated voltage (V) = $\sqrt{\text{Rated power(W)} \times \text{Nominal resistance value } (\Omega)}$
Rated voltage should be lower than (MAX) working voltage.

Power Derating Curve

The rated power is the maximum continuous loading power at 70°C ambient temperature. For ambient temperature above 70°C, the loading power follows the below power derating curve.

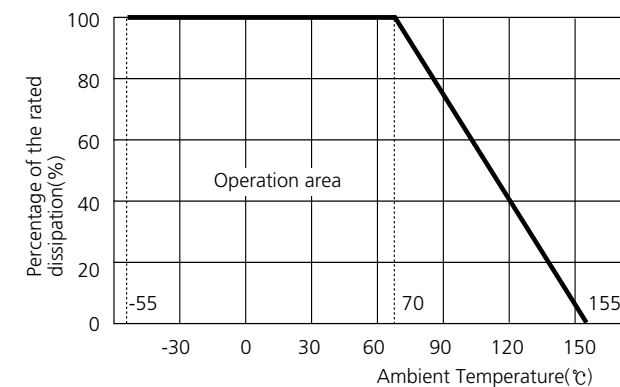

Land Pattern

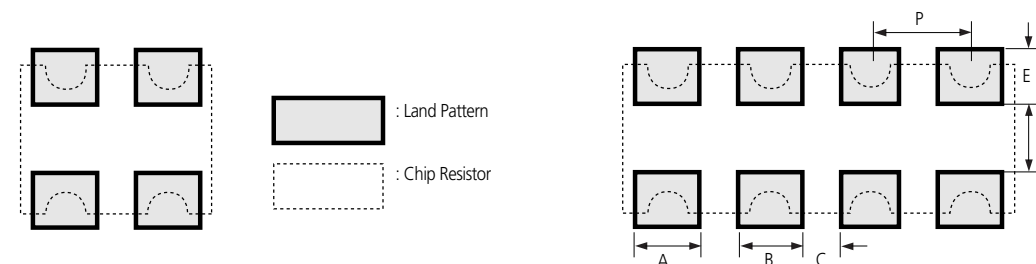

Type	A	B	C	D	E	P
102P	0.3	0.3	0.2	0.5	0.4	0.5
104P	0.3	0.3	0.2	0.5	0.4	0.5

The specifications and designs contained herein may be subject to change without notice. Please contact our sales representatives or product engineers before order.

- Operation Notes
- Example of land Pattern Design
- Recommended Soldering Conditions
- General Structure
- General
- Precision
- Jumper
- Low ohms (RUT Series)
- Ultra Low ohms (RU Series)
- Ultra Low Ohms (RUK Series)
- Ultra Low Ohms (RJ Series)
- Arrays (CONVEX Type)
- Arrays (CONCAVE Type)
- Arrays (FLAT Type)
- Anti-Sulfur Resistors
- Attenuator
- Characteristics Performance
- Packaging
- Standard Resistance Value

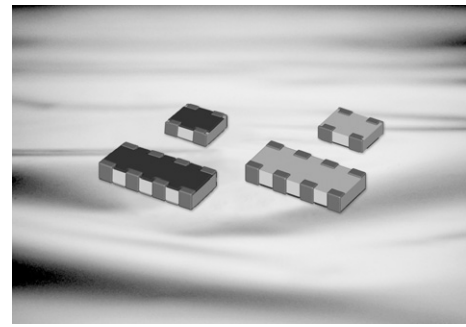

Feature

- Very Small Array.
- Stable and Accurate Resistance.
- Flat Type Terminal.

The product of lead-free terminal is RoHS compliant. PbO(lead oxide) is included in the glass of our product which is prescribed on RoHS appendix as an exception.

Application

- For semiconductor devices.
- For computers, digital circuits.

Structure and Dimensions

(1) Flat Type Array

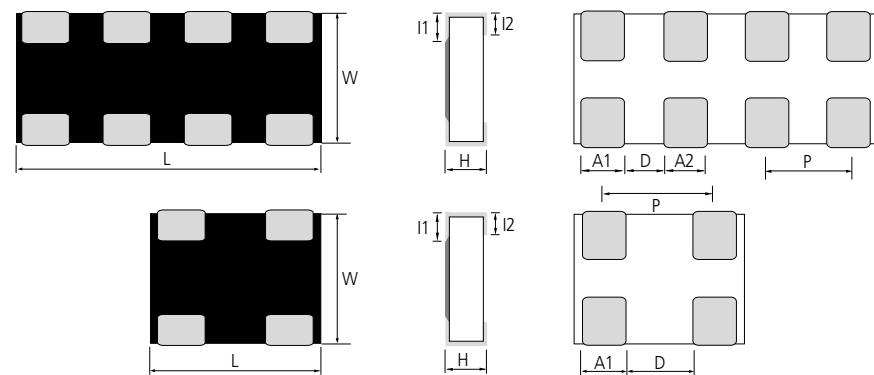

(UNIT: mm)

Type	Inch	L	W	H	A1	A2	D	l1	l2	P	Average Weight
RF062P	0201x2R	0.80±0.05	0.60±0.05	0.23±0.10	0.30±0.10	-	Min 0.1	0.10±0.10	0.20±0.10	0.50±0.05	0.3mg
RF064P	0201x4R	1.40±0.05	0.60±0.05	0.23±0.10	0.25±0.10	0.25±0.10	Min 0.1	0.10±0.10	0.20±0.10	0.35±0.05	0.5mg

(2) Inverted Type Array

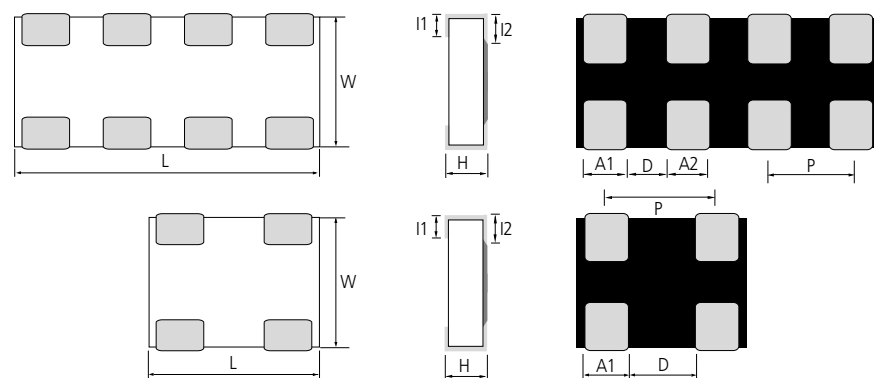

(UNIT: mm)

Type	Inch	L	W	H	A1	A2	D	l1	l2	P	Average Weight
RM062P	0201x2R	0.80±0.05	0.60±0.05	0.23±0.10	0.30±0.10	-	Min 0.1	0.10±0.10	0.20±0.10	0.50±0.05	0.3mg
RM064P	0201x4R	1.40±0.05	0.60±0.05	0.23±0.10	0.30±0.10	0.30±0.10	Min 0.1	0.10±0.10	0.15±0.10	0.40±0.05	0.5mg

Parts Numbering System

- The part number system shall be in the following format

RF	06	4P	J	150	CS
Code Designation	Dimension	Resistors	Tolerance	Resistance Value	Packaging Code
RF : Flat Type Array RM : Inverted Type Array	06: 0603	2P: 2 Pieces 4P: 4 Pieces	J: ±5%	3 digit coding system (IEC coding system) E-24 series	CS : Tape Packaging 7" ES : Tape Packaging 10" AS : Tape Packaging 13"

Specification

Type	Power Rating (W)	Working Voltage (MAX)	Overload Voltage (MAX)	TCR (ppm/°C)	Resistance Range (Ω)	Rated Ambient Temperature	Rated Working Temperature
062P 064P	1/32	12.5(V)	25(V)	±250	10Ω~1MΩ	70°C	-55°C~+125°C

• Rated voltage (V) = $\sqrt{\text{Rated power(W)} \times \text{Nominal resistance value } (\Omega)}$
Rated voltage should be lower than (MAX) working voltage.

Power Derating Curve

The rated power is the maximum continuous loading power at 70°C ambient temperature. For ambient temperature above 70°C, the loading power follows the below power derating curve.

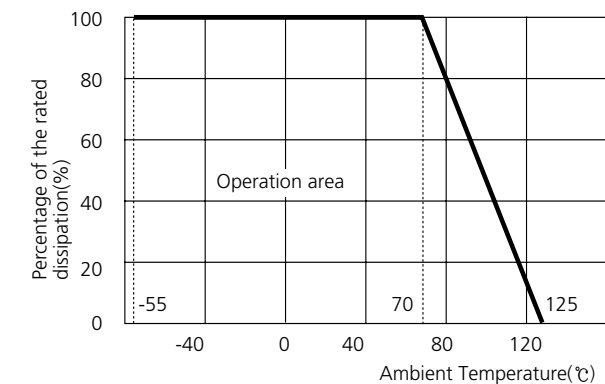

Land Pattern



TYPE (Inch)	Reflow Soldering				
	A	B	2A + B	C	D
062P	0.3	0.3	0.9	0.2	0.3
064P	0.3	0.3	0.9	0.2	0.2

The specifications and designs contained herein may be subject to change without notice. Please contact our sales representatives or product engineers before order.

- Operation Notes
- Example of land Pattern Design
- Recommended Soldering Conditions
- General Structure
- General
- Precision
- Jumper
- Low ohms (RUT Series)
- Ultra Low ohms (RU Series)
- Ultra Low Ohms (RUK Series)
- Ultra Low Ohms (RJ Series)
- Arrays (CONVEX Type)
- Arrays (CONCAVE Type)
- Arrays (FLAT Type)
- Anti-Sulfur Resistors
- Attenuator
- Characteristics Performance
- Packaging
- Standard Resistance Value

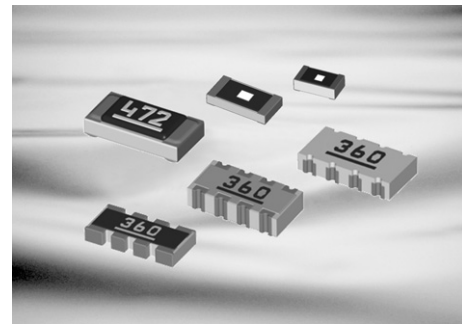

Feature

- Stable in the Sulfur Atmosphere.
- ASTM Satisfied.
- Passed 720hrs with the dried Sulfur at 105°C.
- High Precision Reliability.
- RoHS Compliant.

Application

- Electronic Devices with long-term reliability.
- Server System (Memory Module / HDD).
- Network Equipment.
- Automotive ECU parts.

Structure and Dimensions

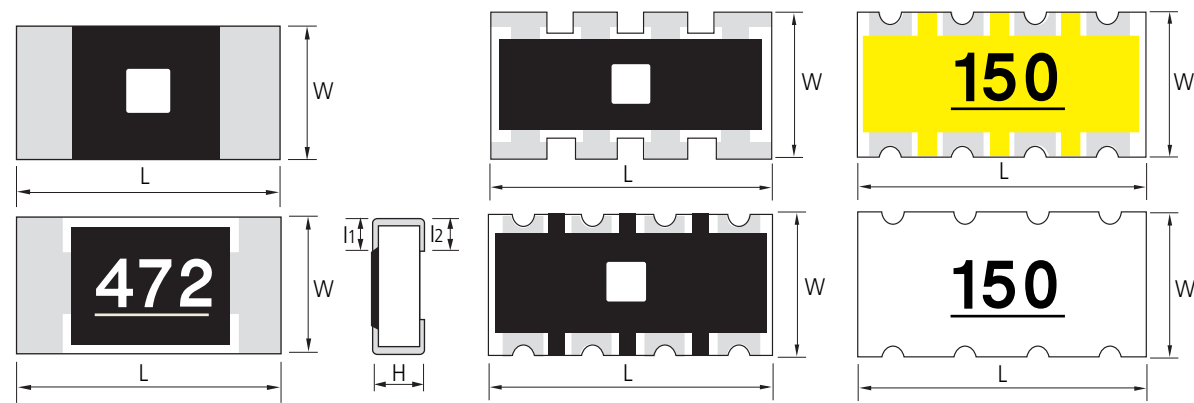

(UNIT: mm)

Type	Inch	L	W	H	A ₁	A ₂	I ₁	I ₂	P	Average Weight
RCS0603	0201	0.60±0.03	0.30±0.03	0.23±0.03			0.10±0.05	0.15±0.05		0.15mg
RCS1005	0402	1.00±0.05	0.50±0.05	0.35±0.05			0.20±0.10	0.25±0.10		0.6mg
RCS1608	0603	1.60±0.10	0.80±0.10	0.45±0.10			0.30±0.20	0.35±0.10		2.1mg
RCS2012	0805	2.00±0.15	1.25±0.15	0.50±0.10			0.40±0.20	0.35±0.20		4.9mg
RCS3216	1206	3.20±0.15	1.60±0.15	0.55±0.10			0.45±0.20	0.40±0.20		9.5mg
RCS3225	1210	3.20±0.20	2.55±0.20	0.55±0.10			0.45±0.20	0.40±0.20		16mg
RCS5025	2010	5.00±0.20	2.50±0.20	0.55±0.10			0.60±0.20	0.60±0.20		26mg
RCS6432	2512	6.30±0.20	3.20±0.20	0.55±0.10			0.60±0.20	0.60±0.20		41mg
RPS102P	0402x2R	1.00±0.10	1.00±0.10	0.35±0.10	0.33±0.10		0.20±0.10	0.25±0.10		1.1mg
RPS104P	0402x4R	2.00±0.10	1.00±0.10	0.35±0.10	0.40±0.15	0.30±0.15	0.15±0.10	0.25±0.10	0.65±0.10	2.2mg
RPS164P	0603x4R	3.20±0.10	1.60±0.10	0.50±0.10	0.40±0.15	0.40±0.15	0.30±0.15	0.30±0.15	0.50±0.15	8.9mg
RNS102P	0402x2R	1.00±0.10	1.00±0.10	0.35±0.10	0.30±0.10	-	0.15±0.10	0.25±0.15	0.80±0.15	1.2mg
RNS104P	0402x4R	2.00±0.10	1.00±0.10	0.40±0.10	0.30±0.10	0.30±0.10	0.15±0.10	0.25±0.15	0.50±0.10	2.8mg
RMS102P	0402x2R	1.00±0.10	1.00±0.10	0.35±0.10	0.30±0.10	-	0.15±0.10	0.25±0.15	0.50±0.10	1.2mg
PMS104P	0402x4R	2.00±0.10	1.00±0.10	0.45±0.10	0.30±0.10	0.30±0.10	0.15±0.10	0.25±0.15	0.50±0.10	2.8mg
RKS102P	0402x2R	1.00±0.10	1.00±0.10	0.35±0.10	0.30±0.10	-	0.15±0.10	0.25±0.15	0.50±0.10	1.2mg
RKS104P	0402x4R	2.00±0.10	1.00±0.10	0.45±0.10	0.30±0.10	0.30±0.10	-	0.25±0.15	0.50±0.10	2.8mg
RFS062P	0201x2R	0.80±0.05	0.60±0.05	0.23±0.10	0.20±0.10	-	0.10±0.10	0.20±0.10	0.50±0.05	0.3mg
RFS064P	0201x4R	1.40±0.05	0.60±0.05	0.23±0.10	0.20±0.10	0.20±0.10	0.10±0.10	0.20±0.10	0.40±0.05	0.5mg
RMS062P	0201x2R	0.80±0.05	0.60±0.05	0.23±0.10	0.20±0.10	-	0.10±0.10	0.20±0.10	0.50±0.05	0.3mg
RMS064P	0201x4R	1.40±0.05	0.60±0.05	0.23±0.10	0.20±0.10	0.20±0.10	0.10±0.10	0.20±0.10	0.40±0.05	0.5mg

Parts Numbering System

• The part number system shall be in the following format

RCS	2012	J	100	CS
Code Designation	Dimension & Size Code	Tolerance	Resistance Value	Packaging Code
RCS: Anti-sulfur General Type	0603: 0.6 × 0.3(mm) - 0201(inch)	F : ±1%	3 or 4 digits coding system	GS: Bulk Packaging
RPS: Anti-sulfur Convex Array	1005: 1.0 × 0.5(mm) - 0402(inch)	G : ±2%	(IEC coding system)	CS: Tape Packaging 7"
RNS: Anti-sulfur Concave Array	1608: 1.6 × 0.8(mm) - 0603(inch)	J : ±5%	3digits (E-24 series)	ES: Tape Packaging 10"
RMS: Anti-sulfur Inverted Array	2012: 2.0 × 1.2(mm) - 0805(inch)	K : ±10%	4digits (E-96 series)	AS: Tape Packaging 13"
RKS: Anti-sulfur Short-Free Array	3216: 3.2 × 1.6(mm) - 1206(inch)			
	3225: 3.2 × 2.5(mm) - 1210(inch)			
	5025: 5.0 × 2.5(mm) - 2010(inch)			
	6432: 6.4 × 3.2(mm) - 2512(inch)			
	062P: 0603 × 2R (0201x2R)			
	064P: 0603 × 4R (0201x4R)			
	102P: 0603 × 2R (0402x2R)			
	104P: 1005 × 4R (0402x4R)			
	164P: 1608 × 4R (0603x4R)			

Specification

Type	Power Rating (W)	Working Voltage (MAX)	Overload Voltage (MAX)	TCR (ppm/°C)	Resistance Range (Ω)	Rated Ambient Temperature	Rated Working Temperature
RC 0603	1/20	25(V)	50(V)	1~99 Ω : +300,200 10 Ω~1MΩ: ±100 (0603 : ±250) 1.1 MΩ~10 MΩ: ±300	1 Ω~10MΩ	70°C	-55°C~+125°C
RC 1005	1/16	50(V)	100(V)				
RC 1608	1/10						
RC 2012	1/8	150(V)	300(V)				
RC 3216	1/4	200(V)	400(V)				
RC 3225	1/3						
RC 5025	2/3						
RC 6432	1						
062P	1/32	12.5(V)	25(V)	±250	10 Ω~1MΩ	70°C	-55°C~+125°C
064P							
102P	1/16	25(V)	50(V)	1~99 Ω : ±300 10 Ω~1MΩ: ±200	1 Ω~1MΩ	70°C	-55°C~+155°C
104P		25(V)	50(V)				
164P		50(V)	100(V)				

• Rated voltage (V) = $\sqrt{\text{Rated power(W)} \times \text{Nominal resistance value (R)}}$
 Rated voltage should not exceed the working voltage.

Power Derating Curve

The rated power is the maximum continuous loading power at 70°C ambient temperature. For ambient temperature above 70°C, the loading power follows the below power derating curve. (The load current shall be derated according to derating curve in case of the 'Jumper')

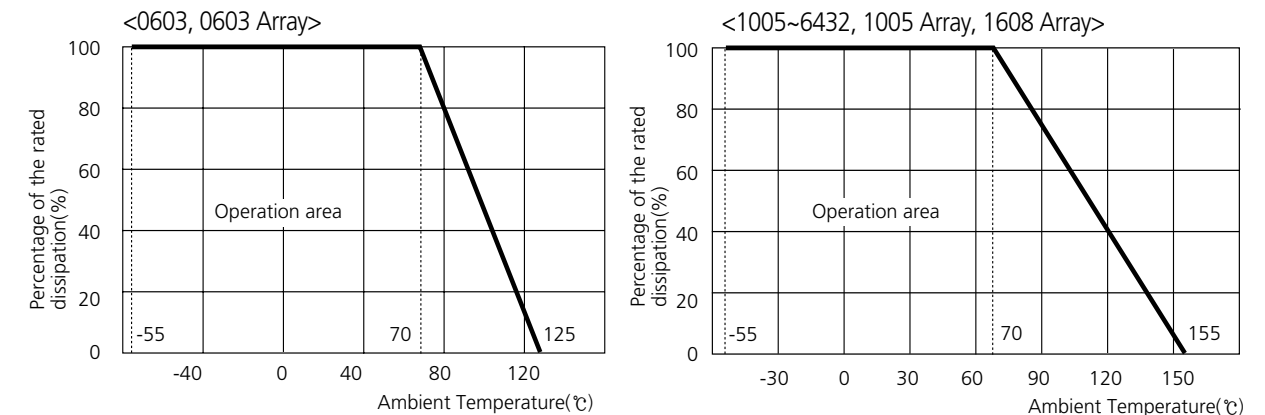

Sulfur Corrosion Test

Test name	Adding Material	Temperature	Duration Time	Decision Criteria
ASTM B-809-5	Sulfur 50 g KONs 200 g DI water 200ml	50°C	1000hr	ΔR<±1%
Dry Sulfur (IBM recommended)	Sulfur 50 g	105°C	720hr	ΔR<±1%

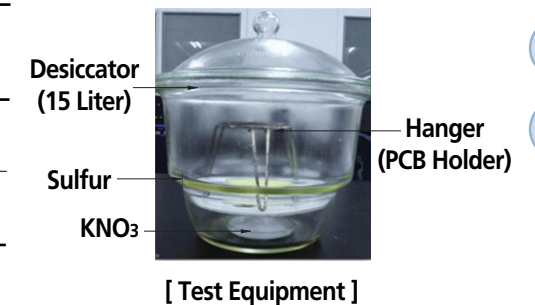

- Operation Notes
- Example of land Pattern Design
- Recommended Soldering Conditions
- General Structure
- General
- Precision
- Jumper
- Low ohms (RUT Series)
- Ultra Low ohms (RU Series)
- Ultra Low Ohms (RUK Series)
- Ultra Low Ohms (RJ Series)
- Arrays (CONVEX Type)
- Arrays (CONCAVE Type)
- Arrays (FLAT Type)
- Anti-Sulfur Resistors
- Attenuator
- Characteristics Performance
- Packaging
- Standard Resistance Value

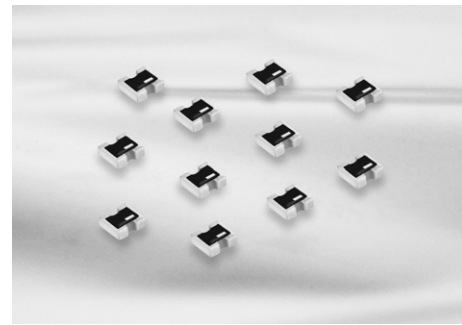

Feature

- The RP10AT is small-size chip Attenuator, suitable for high density surface mounting.
- Unbalanced π type attenuator circuit in one chip(1.0 mm x 1.0 mm).
- Mounting occupation area reduction : about 50 % reduction.
- Mounting cost reduction : Mounting times 3 times \rightarrow 1 time.
- Attenuation : 0 dB to 10 dB.

Application

- Attenuation / level control / impedance matching of high frequency signals of communication equipment; cellular phones(GSM, CDMA, etc.), PHS, PDA, for example.

Structure and Dimensions

• Structure

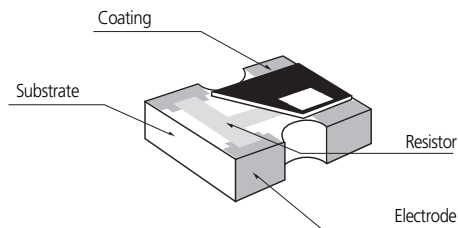

• Dimensions

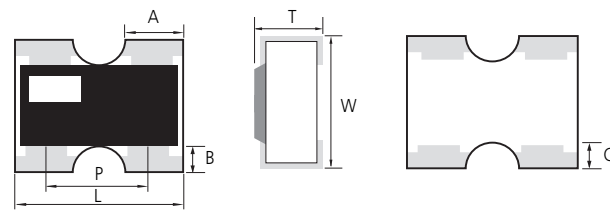

(UNIT: mm)

Type	Power(W)	L	W	T	A	B	C	P	Average Weight
RP10AT	0.04W / package	1.00 \pm 0.10	1.00 \pm 0.10	0.35 \pm 0.10	0.33 \pm 0.05	0.20 \pm 0.10	0.25 \pm 0.10	0.65 \pm 0.10	1.1mg

Parts Numbering System

- The part number system shall be in the following format

RP	10AT	L	A	03	CS
Code Designation	Dimensions & Circuit Configuration	Attenuation Value Tolerance	Characteristic Impedance	Attenuation Value	Packing Type
RP: Convex type	10: 1.0x1.0(mm) - 0404(inch) AT: Unbalanced π -type Attenuator	L : \pm 0.3 dB H : \pm 0.5 dB	A : 50 ohm	3 dB EX) 0 \rightarrow 0dB	CS: Tape Packaging 7"

Specification

Item	Specifications
Attenuation Value	0 dB~15dB
Attenuation Value Tolerance	0 dB~5 dB : \pm 0.3 dB 6 dB~15dB : \pm 0.5 dB
Characteristic Impedance	50 Ω
Power Rating	0.04W / package
Frequency Range	DC to 3 GHz
VSWR (Voltage Standing Wave Ratio)	1.3 max
Number of terminals	4 terminals
Category Temperature Range (Operating Temperature Range)	-55 $^{\circ}$ C to +125 $^{\circ}$ C

Power Derating Curve

The rated power is the maximum continuous loading power at 70 $^{\circ}$ C ambient temperature. For ambient temperature above 70 $^{\circ}$ C, the loading power follows the below power derating curve.

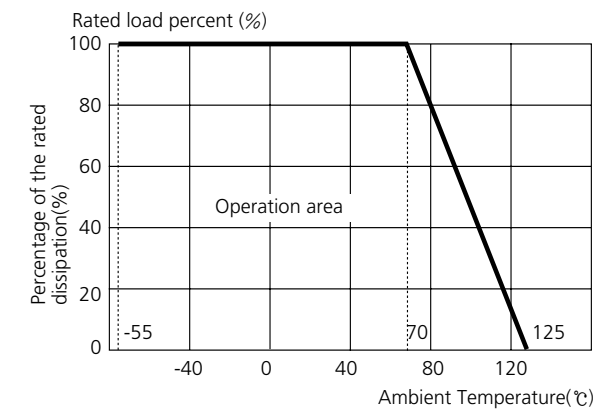

Equivalent Circuit Configuration

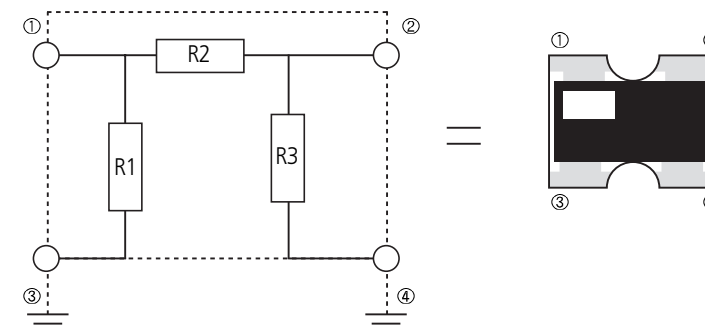

The specifications and designs contained herein may be subject to change without notice. Please contact our sales representatives or product engineers before order.

Operation Notes

Example of land Pattern Design

Recommended Soldering Conditions

General Structure

General

Precision

Jumper

Low ohms (RUT Series)

Ultra Low ohms (RU Series)

Ultra Low Ohms (RUK Series)

Ultra Low Ohms (RJ Series)

Arrays (CONVEX Type)

Arrays (CONCAVE Type)

Arrays (FLAT Type)

Anti-Sulfur Resistors

Attenuator

Characteristics Performance



Packaging

Standard Resistance Value

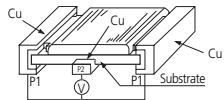
Electrical Characteristic

Item	Requirements Specification		Test Methods	
	Resistor	Jumper	Resistor	Jumper
Direct Current Resistance	Within the regulated resistance tolerance.	50mΩ Max.	JIS C 5201-1 4.5 Voltage apply Within 5 sec. Test temp: 20℃, 65RH Test board: <FIG. 1>	
Temperature Characteristic	<ul style="list-style-type: none"> ■J-Grade 1Ω ≤ R < 10Ω : ±300/-200ppm/℃ 10Ω ≤ R ≤ 1MΩ : ±100ppm/℃(0603±250ppm) 1MΩ < R ≤ 10MΩ : ±300ppm/℃ ■F-Grade 1Ω ≤ R ≤ 10MΩ : ±100ppm/℃(0603±250ppm) 		JIS C 5201-1 4.8 Test Temperature(℃) 20℃ → -55℃ / 20℃ → 125℃ T.C.R(ppm / ℃)=(R-R ₂₀) / R ₂₀ × 1 / (T-T ₂₀) × 10 ⁶ ※T=test Temperature, T ₂₀ =20℃ R=Resistance at T, R ₂₀ =Resistance at T ₂₀ Test board: <FIG. 1>	
Short-time Overload	ΔR	Less than ±(1%+0.1Ω) of the initial value.	50mΩ Max.	Max Surge Current
	Visual	No evidence of mechanical damage.		
Intermittent Overload	ΔR	Less than ±(3%+0.1Ω) of the initial value.	50mΩ Max.	Max Surge Current
	Visual	No evidence of mechanical damage.		
Dielectric Withstanding Voltage	No evidence of mechanical damage.		JIS C 5201-1 4.7 Apply Voltage for 1 minute 0402,0603:50V 1005, 1608: 100V Other: 500V	
Insulation Resistance	Over 1,000MΩ			

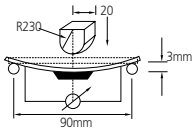
Mechanical Characteristic

Item	Requirements Specification		Test Methods	
	Resistor	Jumper	Resistor	Jumper
Solderability	Coverage: ≥95% each termination. No crack of termination parts and ceramic exposure of surface by melting.		IEC60068-2-58 Rosin Flux: Rosin 25%, Methanol 75% Solder Temp.: 245±5/-0℃ Dipping time: 2±0.5 sec.(Both side dipping)	
Bending Test	ΔR	Less than ±(1.0%+0.05Ω) of the initial value.	50mΩ Max.	
	Visual	No evidence of mechanical damage.		
Adhesive strength of termination	·No mechanical damage or sign of disconnection		JIS C 5201-1(4.16) - Test strength : 5N (500g · f), 0603 : 2N - Test time : Applying pressure for 10 seconds 	
Resistance to Soldering Heat	ΔR	Less than ±(1%+0.05Ω) of the initial value.	50mΩ Max.	JIS C 5201-1 4.18 - Flow soldering : 260±5℃, 10 sec. max.(both side dipping) - Reflow soldering : 260±5℃, 10 sec. max. over 230℃, 30~40 sec.
	Visual	No evidence of mechanical damage.		
Anti-Vibration Test	ΔR	Less than ±(1%+0.05Ω) of the initial value.	50mΩ Max.	JIS C 5201-1 4.22 2 hours each in X, Y and Z axis(total 6 hours) 10 to 55Hz sweep in 1 minute at 1.5mm amplitude.
	Visual	No evidence of mechanical damage.		

Environmental Characteristic

Item	Requirements Specification		Test Methods	
	Resistor	Jumper	Resistor	Jumper
Temperature Cycle	ΔR	Less than ±(1%+0.1Ω) of the initial value.	50mΩ Max.	JIS C 5201-1 4.19 Perform 100 cycles as follows. Test Condition: -55℃/30min ↔ 125℃/30min sweep time: 5 min Test board: <FIG. 1>
	Visual	No evidence of mechanical damage.		
Load Life	ΔR	Less than ±(3%+0.1Ω) of the initial value.	50mΩ Max.	JIS C 5201-1 4.25 Test Voltage: rated voltage Test temp.: 70±2℃ Time: 1,000 ^{±48} hours(90 min; ON, 30 min; OFF) Test board: <FIG. 1>
	Visual	No evidence of mechanical damage.		
Low Temp. Exposure	ΔR	Less than ±(3%+0.1Ω) of the initial value.	50mΩ Max.	JIS C 5201-1 4.23 Dwell in -55℃ chamber without loading for 1,000 ^{±48} hours. Stabilize for 60 minutes at room temperature. Measure value. Test board: <FIG. 1>
	Visual	No evidence of mechanical damage.		
High Temp. Exposure	ΔR	Less than ±(3%+0.1Ω) of the initial value.	50mΩ Max.	JIS C 5201-1 4.23 Dwell in 125℃±2℃ or 155℃±2℃ chamber without loading for 1,000 ^{±48} hours. Stabilize for 60 minutes at room temperature. Measure value. Test board: <FIG. 1>
	Visual	No evidence of mechanical damage.		
Moisture Resistance	ΔR	Less than ±(3%+0.1Ω) of the initial value.	50mΩ Max.	JIS C 5201-1 4.14 Test Voltage: rated voltage Test temp.: 40±2℃ Time: 1,000 ^{±48} hours(90 min; ON, 30 min; OFF) Humidity: 90~95% RH Stabilize for 1 hrs & Measure. Test board: <FIG. 1>
	Visual	No evidence of mechanical damage.		

* These characteristics apply to 1Ω ~ 10MΩ. In case of other resistance range, please contact us.

* The next is specification in our company for flow soldering and test boards.

Flow soldering Conditions

Item	Specification	Dipping
Flux	ROSIN 25%, IPA 75%	Time: 5~10 sec.
Solder	Sn-3.0Ag-0.5Cu	Time: 10 sec max. Temp.: 260±5℃.

Operation Notes

Example of land Pattern Design

Recommended Soldering Conditions

General Structure

General

Precision

Jumper

Low ohms (RUT Series)

Ultra Low ohms (RU Series)

Ultra Low Ohms (RUK Series)

Ultra Low Ohms (RJ Series)

Arrays (CONVEX Type)

Arrays (CONCAVE Type)

Arrays (FLAT Type)

Anti-Sulfur Resistors

Attenuator

Characteristics Performance

Packaging

Standard Resistance Value

Taping Type

• Reel dimensions

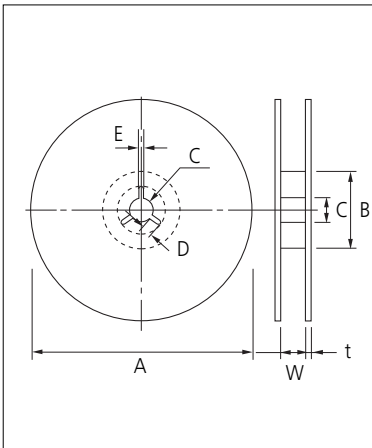

Unit: mm

Symbol	Tape Width	A	B	C	D
7" Reel	8mm	∅180+0/-3	∅60±1.0	∅13±0.3	4±0.2
	12mm	∅180+0/-3	∅60±1.0	∅13±0.3	4±0.2
10" Reel	8mm	∅258+0/-3	∅80±1.0	∅13±0.3	4±0.2
	12mm	∅258+0/-3	∅80±1.0	∅13±0.3	4±0.2
13" Reel	8mm	∅330±2.0	∅100±1.0	∅13±0.3	4±0.2
	12mm	∅330±2.0	∅80±1.0	∅13±0.3	4±0.2

Symbol	Tape Width	E	W	t
7" Reel	8mm	2.0±0.5	9±0.5	1.2±0.2
	12mm	2.0±0.5	13±0.5	1.2±0.2
10" Reel	8mm	2.0±0.5	9±0.5	1.8±0.2
	12mm	2.0±0.5	13±0.5	1.8±0.2
13" Reel	8mm	2.0±0.5	9±0.5	2.2±0.2
	12mm	2.0±0.5	13±0.5	2.2±0.2

• Tape dimensions

(UNIT: mm)

Type	Pitch	Width	Dimensions																																												
Press Pocket or Punched Paper	2mm	8mm	<table border="1"> <thead> <tr> <th></th> <th>A</th> <th>B</th> <th>T</th> </tr> </thead> <tbody> <tr><td>0402</td><td>0.24±0.03</td><td>0.45±0.03</td><td>0.5 Max</td></tr> <tr><td>0603</td><td>0.38±0.05</td><td>0.68±0.05</td><td>0.5 Max</td></tr> <tr><td>1005</td><td>0.70±0.10</td><td>1.20±0.10</td><td>0.6 Max</td></tr> <tr><td>RF062P</td><td>0.70±0.10</td><td>0.90±0.10</td><td>0.35 Max</td></tr> <tr><td>RF064P</td><td>0.70±0.10</td><td>1.60±0.10</td><td>0.35 Max</td></tr> <tr><td>RP102</td><td>1.17±0.10</td><td>1.17±0.10</td><td>0.6 Max</td></tr> <tr><td>RP10AT</td><td>1.20±0.10</td><td>1.20±0.10</td><td>0.6 Max</td></tr> <tr><td>RN102</td><td>1.20±0.10</td><td>1.20±0.10</td><td>0.6 Max</td></tr> <tr><td>RP104</td><td>1.20±0.10</td><td>2.20±0.10</td><td>0.6 Max</td></tr> <tr><td>RN104</td><td>1.20±0.10</td><td>2.20±0.10</td><td>0.8 Max</td></tr> </tbody> </table> <p>-0603: Press pocket.</p>		A	B	T	0402	0.24±0.03	0.45±0.03	0.5 Max	0603	0.38±0.05	0.68±0.05	0.5 Max	1005	0.70±0.10	1.20±0.10	0.6 Max	RF062P	0.70±0.10	0.90±0.10	0.35 Max	RF064P	0.70±0.10	1.60±0.10	0.35 Max	RP102	1.17±0.10	1.17±0.10	0.6 Max	RP10AT	1.20±0.10	1.20±0.10	0.6 Max	RN102	1.20±0.10	1.20±0.10	0.6 Max	RP104	1.20±0.10	2.20±0.10	0.6 Max	RN104	1.20±0.10	2.20±0.10	0.8 Max
				A	B	T																																									
0402	0.24±0.03	0.45±0.03	0.5 Max																																												
0603	0.38±0.05	0.68±0.05	0.5 Max																																												
1005	0.70±0.10	1.20±0.10	0.6 Max																																												
RF062P	0.70±0.10	0.90±0.10	0.35 Max																																												
RF064P	0.70±0.10	1.60±0.10	0.35 Max																																												
RP102	1.17±0.10	1.17±0.10	0.6 Max																																												
RP10AT	1.20±0.10	1.20±0.10	0.6 Max																																												
RN102	1.20±0.10	1.20±0.10	0.6 Max																																												
RP104	1.20±0.10	2.20±0.10	0.6 Max																																												
RN104	1.20±0.10	2.20±0.10	0.8 Max																																												
Punched Paper	4mm	8mm	<table border="1"> <thead> <tr> <th></th> <th>A</th> <th>B</th> <th>T</th> </tr> </thead> <tbody> <tr><td>1608</td><td>1.10±0.20</td><td>1.90±0.20</td><td>0.8 Max</td></tr> <tr><td>2012</td><td>1.65±0.20</td><td>2.40±0.20</td><td>1.1 Max</td></tr> <tr><td>3216</td><td>2.00±0.20</td><td>3.60±0.20</td><td>1.1 Max</td></tr> <tr><td>3225</td><td>2.90±0.20</td><td>3.60±0.20</td><td>1.1 Max</td></tr> <tr><td>RP164</td><td>2.00±0.20</td><td>3.60±0.20</td><td>1.1 Max</td></tr> </tbody> </table>		A	B	T	1608	1.10±0.20	1.90±0.20	0.8 Max	2012	1.65±0.20	2.40±0.20	1.1 Max	3216	2.00±0.20	3.60±0.20	1.1 Max	3225	2.90±0.20	3.60±0.20	1.1 Max	RP164	2.00±0.20	3.60±0.20	1.1 Max																				
				A	B	T																																									
1608	1.10±0.20	1.90±0.20	0.8 Max																																												
2012	1.65±0.20	2.40±0.20	1.1 Max																																												
3216	2.00±0.20	3.60±0.20	1.1 Max																																												
3225	2.90±0.20	3.60±0.20	1.1 Max																																												
RP164	2.00±0.20	3.60±0.20	1.1 Max																																												
Embossed Tape	12mm	12mm	<table border="1"> <thead> <tr> <th></th> <th>A</th> <th>B</th> <th>T</th> </tr> </thead> <tbody> <tr><td>5025</td><td>2.80±0.20</td><td>5.30±0.20</td><td>1.1 Max</td></tr> <tr><td>6432</td><td>3.50±0.20</td><td>6.75±0.20</td><td>1.1 Max</td></tr> </tbody> </table>		A	B	T	5025	2.80±0.20	5.30±0.20	1.1 Max	6432	3.50±0.20	6.75±0.20	1.1 Max																																
				A	B	T																																									
5025	2.80±0.20	5.30±0.20	1.1 Max																																												
6432	3.50±0.20	6.75±0.20	1.1 Max																																												

Packaging Table

TYPE (mm)	TYPE (inch)	Taping Packaging					
		Code	Reels	Carrier Tape	Quantity	Weight(g)	
0402	01005	CS	7"	Pressed Paper	20,000	143	
		AS	13"	Pressed Paper	15,000	126	
0603	0201	DP	7"	Punched PE	20,000	154	
		AS	13"	Pressed Paper	60,000	573	
		FP	13"	Punched PE	50,000	474	
		CS	7"	Punched paper	10,000	92	
DS	7"	20,000	152				
ES	10"	30,000	331				
AS	13"	40,000	539				
1005	0402	CS	7"	Punched paper	5,000	125	
		ES	10"		10,000	324	
AS	13"	20,000	561				
AS	13"	5,000	149				
1608	0603	CS	7"	Punched paper	10,000	360	
		ES	10"		20,000	658	
		AS	13"		5,000	157	
AS	13"	10,000	382				
2012	0805	CS	7"	Punched paper	5,000	183	
		ES	10"		10,000	463	
AS	13"	20,000	674				
AS	13"	20,000	695				
3216	1206	CS	7"	Punched paper	5,000	202	
		ES	10"		10,000	485	
AS	13"	20,000	1,041				
AS	13"	20,000	126				
3225	1210	CS	7"	Embossed PE	4,000	267	
		ES	10"		10,000	485	
AS	13"	20,000	1,041				
AS	13"	20,000	126				
5025	2010	CS	7"	Embossed PE	4,000	267	
		AS	13"		15,000	1,041	
6432	2512	CS	7"		Embossed PE	4,000	267
		AS	13"			15,000	1,041
062P	0201×2R	CS	7"	Punched paper		20,000	126
		AS	13"			20,000	126
064P	0201×4R	CS	7"		Punched paper	10,000	100
		AS	13"			40,000	485
102P	0402×2R	CS	7"	Punched paper		10,000	136
		AS	13"			40,000	610
104P	0402×4R	CS	7"		Punched paper	5,000	157
		AS	13"			20,000	695
164P	0603×4R	CS	7"	Punched paper		10,000	100
		AS	13"			40,000	485
10AT (1010)	0404	CS	7"		Punched paper	10,000	100
		AS	13"			40,000	485

- General type, Precision, Low ohms, High ohms.
- Packaging style can be modified when you want.

- Operation Notes
- Example of land Pattern Design
- Recommended Soldering Conditions
- General Structure
- General
- Precision
- Jumper
- Low ohms (RUT Series)
- Ultra Low ohms (RU Series)
- Ultra Low Ohms (RUK Series)
- Ultra Low Ohms (RJ Series)
- Arrays (CONVEX Type)
- Arrays (CONCAVE Type)
- Arrays (FLAT Type)
- Anti-Sulfur Resistors
- Attenuator
- Characteristics Performance
- Packaging
- Standard Resistance Value

Tolerance Code Table

Tolerance Code	D	F	G	J	K	M
Digit Number	4 digit			3 digit		
IEC-Code System	E-192	E-96	E-48	E-24	E-12	E-6
Specification	±0.5%	±1%	±2%	±5%	±10%	±20%

Significant Figure of Resistance Value

E-192	E-96	E-48	E-24	E-192	E-96	E-48	E-24	E-192	E-96	E-48	E-24	E-192	E-96	E-48	E-24
100	100	100	10	178	178	178	18	316	316	316		562	562	562	56
101				180				320				569			
102	102			182	182			324	324			576	576		
104				184				328				583			
105	105	105		187	187	187		332	332	332	33	590	590	590	
106				189				336				597			
107	107			191	191			340	340			604	604		
109				193				344				612			
110	110	110	11	196	196	196		348	348	348		619	619	619	
111				198				352				626			62
113	113			200	200		20	357	357			634	634		
114				203				361			36	642			
115	115	115		205	205	205		365	365	365		649	649	649	
117				208				370				657			
118	118			210	210			374	374			665	665		
120			12	213				379				673			
121	121	121		215	215	215		383	383	383		681	681	681	68
123				218				388				690			
124	124			221	221		22	392	392		39	698	698		
126				223				397				706			
127	127	127		226	226	226		402	402	402		715	715	715	
129				229				407				723			
130	130		13	232	232			412	412			732	732		
132				234				417				741			
133	133	133		237	237	237		422	422	422		750	750	750	75
135				240			24	427			43	759			
137	137			243	243			432	432			768	768		
138				246				437				777			
140	140	140		249	249	249		442	442	442		787	787	787	
142				252				448				796			
143	143			255	255			453	453			806	806		
145				258				459				816			
147	147	147		261	261	261		464	464	464		825	825	825	82
149				264				470			47	835			
150	150		15	267	267			475	475			845	845		
152				271			27	481				856			
154	154	154		274	274	274		487	487	487		866	866	866	
156				277				493				876			
158	158			280	280			499	499			887	887		
160			16	284				505				898			
162	162	162		287	287	287		511	511	511	51	909	909	909	
164				291				517				920			91
165	165			294	294			523	523			931	931		
167				298				530				942			
169	169	169		301	301	301	30	536	536	536		953	953	953	
172				305				542				965			
174	174			309	309			549	549			976	976		
176				312				556				988			

• Example

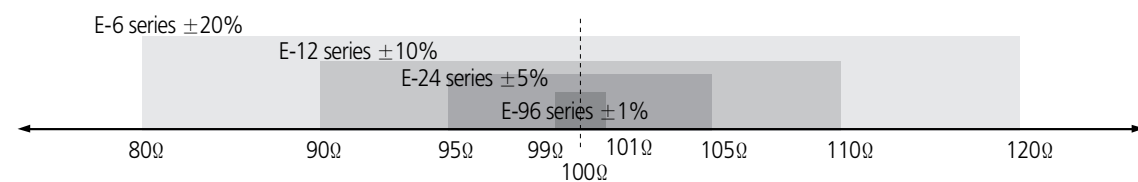

- Operation Notes
- Example of land Pattern Design
- Recommended Soldering Conditions
- General Structure
- General
- Precision
- Jumper
- Low ohms (RUT Series)
- Ultra Low ohms (RU Series)
- Ultra Low Ohms (RUK Series)
- Ultra Low Ohms (RJ Series)
- Arrays (CONVEX Type)
- Arrays (CONCAVE Type)
- Arrays (FLAT Type)
- Anti-Sulfur Resistors
- Attenuator
- Characteristics Performance
- Packaging
- Standard Resistance Value**

Attention

- This catalogue is valid only to the products purchased either from us or through our official distributors.
- Product specifications included in this catalogue are effective as of March 1, 2013. Please be advised that they are standard product specifications for reference only. We may change, modify or discontinue the product specifications without notice at any time. So, you need to approve the product specifications before placing an order. Should you have any question regarding our product specifications, please contact our sales personnel or application engineers.
- We may modify or cease to produce the products listed in this catalogue without notice. Should you have any question, please contact our sales personnel or application engineers.
- Without obtaining our permission, you should not be allowed to reproduce, copy, use or transfer any content or information contained this catalogue in any manner whatsoever for any purpose.
- In no event, will we be responsible for any claim, dispute, damage or liability whatsoever arising from, relating to or in connection with your misuse of the products or/and information included in this catalogue. We will also not assume any responsibilities whatsoever for any claim, dispute, damage or liability with regards to the intellectual property rights or other related rights of ours or any third party associated with your use of our products and/or information contained in this catalogue. We expressly disclaim that no license is granted regarding the aforementioned rights.
- Please note that the products in this catalogue are not designed or intended to use for the applications set forth below. So, if you intend to use the products in this catalogue for the applications listed below, you should contact our sales personnel or application engineers before using. Please be aware that any misuse of the products deviating from product specifications or information provided in this catalogue may cause a serious property damage or a personal injury.
 - Aerospace/Aviation equipment
 - Transportation equipment (vehicles, trains, ships, etc)
 - Medical equipment
 - Military equipment
 - Disaster prevention/crime prevention equipment
 - Any other applications with the same as or similar complexity or reliability to the applications set forth above.



Quality System Certification List

Table 1: Certification list of Samsung Factory

Certification	Section	High Tech(China)
ISO / TS 16949	Authority	BSI
	Number	TS 91430-008
	Date	2011 - 11 - 29
	Validity	2014 - 11 - 28
ISO 14001	Authority	BSI
	Number	EMS 585307
	Date	2012 - 04 - 17
	Validity	2015 - 04 - 16
OHSAS 18001	Authority	BSI
	Number	OHS 585308
	Date	2012 - 04 - 17
	Validity	2015 - 04 - 16
QC080000	Authority	UL
	Number	PRC-HSPM-1766
	Date	2010 - 07 - 27
	Validity	2013 - 07 - 26

- Operation Notes
- Example of land Pattern Design
- Recommended Soldering Conditions
- General Structure
- General
- Precision
- Jumper
- Low ohms (RUT Series)
- Ultra Low ohms (RU Series)
- Ultra Low Ohms (RUK Series)
- Ultra Low Ohms (RJ Series)
- Arrays (CONVEX Type)
- Arrays (CONCAVE Type)
- Arrays (FLAT Type)
- Anti-Sulfur Resistors
- Attenuator
- Characteristics Performance
- Packaging
- Standard Resistance Value