

The RF MOSFET Line
RF Power Field Effect Transistors
N-Channel Enhancement-Mode Lateral MOSFETs

MRF21060R3
MRF21060SR3

Designed for PCN and PCS base station applications with frequencies from 2.1 to 2.2 GHz. Suitable for W-CDMA, CDMA, TDMA, GSM and multicarrier amplifier applications.

- Typical W-CDMA Performance: 2140 MHz, 28 Volts
 5 MHz Offset @ 4.096 MHz BW, 15 DTCH
 Output Power — 6.0 Watts
 Power Gain — 12.5 dB
 Drain Efficiency — 15%
- Internally Matched, Controlled Q, for Ease of Use
- High Gain, High Efficiency and High Linearity
- Integrated ESD Protection
- Designed for Maximum Gain and Insertion Phase Flatness
- Capable of Handling 10:1 VSWR, @ 28 Vdc, 2.11 GHz, 60 Watts CW Output Power
- Excellent Thermal Stability
- Characterized with Series Equivalent Large-Signal Impedance Parameters
- In Tape and Reel. R3 Suffix = 250 Units per 56 mm, 13 Inch Reel.

2170 MHz, 60 W, 28 V
LATERAL N-CHANNEL
RF POWER MOSFETs

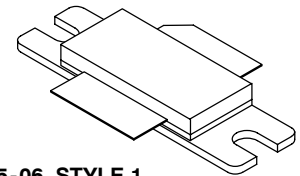

CASE 465-06, STYLE 1
NI-780
MRF21060R3

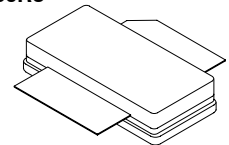

CASE 465A-06, STYLE 1
NI-780S
MRF21060SR3

MAXIMUM RATINGS

Rating	Symbol	Value	Unit
Drain-Source Voltage	V_{DSS}	65	Vdc
Gate-Source Voltage	V_{GS}	-0.5, +15	Vdc
Total Device Dissipation @ $T_C = 25^\circ\text{C}$ Derate above 25°C	P_D	180 0.98	Watts W/ $^\circ\text{C}$
Storage Temperature Range	T_{stg}	- 65 to +150	$^\circ\text{C}$
Operating Junction Temperature	T_J	200	$^\circ\text{C}$

THERMAL CHARACTERISTICS

Characteristic	Symbol	Value	Unit
Thermal Resistance, Junction to Case	$R_{\theta JC}$	1.02	$^\circ\text{C}/\text{W}$

ESD PROTECTION CHARACTERISTICS

Test Conditions	Class
Human Body Model	2 (Minimum)
Machine Model	M3 (Minimum)

NOTE - **CAUTION** - MOS devices are susceptible to damage from electrostatic charge. Reasonable precautions in handling and packaging MOS devices should be observed.

Freescale Semiconductor, Inc.

ELECTRICAL CHARACTERISTICS (T_C = 25°C unless otherwise noted)

Characteristic	Symbol	Min	Typ	Max	Unit
OFF CHARACTERISTICS					
Drain-Source Breakdown Voltage (V _{GS} = 0 Vdc, I _D = 10 μAdc)	V _{(BR)DSS}	65	—	—	Vdc
Zero Gate Voltage Drain Current (V _{DS} = 28 Vdc, V _{GS} = 0 Vdc)	I _{DSS}	—	—	6	μAdc
Gate-Source Leakage Current (V _{GS} = 5 Vdc, V _{DS} = 0 Vdc)	I _{GSS}	—	—	1	μAdc
ON CHARACTERISTICS					
Gate Threshold Voltage (V _{DS} = 10 Vdc, I _D = 300 μAdc)	V _{GS(th)}	2	—	4	Vdc
Gate Quiescent Voltage (V _{DS} = 28 Vdc, I _D = 500 mAdc)	V _{GS(Q)}	2.5	3.9	4.5	Vdc
Drain-Source On-Voltage (V _{GS} = 10 Vdc, I _D = 2 Adc)	V _{DS(on)}	—	0.27	—	Vdc
Forward Transconductance (V _{DS} = 10 Vdc, I _D = 2 Adc)	g _{fs}	—	4.7	—	S
DYNAMIC CHARACTERISTICS					
Reverse Transfer Capacitance (1) (V _{DS} = 28 Vdc, V _{GS} = 0, f = 1 MHz)	C _{rss}	—	2.7	—	pF
FUNCTIONAL TESTS (In Motorola Test Fixture, 50 ohm system)					
Two-Tone Common-Source Amplifier Power Gain (V _{DD} = 28 Vdc, P _{out} = 60 W PEP, I _{DQ} = 500 mA, f = 2110 MHz and 2170 MHz, Tone Spacing = 100 kHz)	G _{ps}	11	12.5	—	dB
Two-Tone Drain Efficiency (V _{DD} = 28 Vdc, P _{out} = 60 W PEP, I _{DQ} = 500 mA, f = 2110 MHz and 2170 MHz, Tone Spacing = 100 kHz)	η	31	34	—	%
3rd Order Intermodulation Distortion (V _{DD} = 28 Vdc, P _{out} = 60 W PEP, I _{DQ} = 500 mA, f = 2110 MHz and 2170 MHz, Tone Spacing = 100 kHz)	IMD	—	-30	-28	dBc
Input Return Loss (V _{DD} = 28 Vdc, P _{out} = 60 W PEP, I _{DQ} = 500 mA, f = 2110 MHz and 2170 MHz, Tone Spacing = 100 kHz)	IRL	—	-12	—	dB
P _{out} 1 dB Compression Point (V _{DD} = 28 Vdc, P _{out} = 60 W CW, f = 2170 MHz)	P1dB	—	60	—	W
Output Mismatch Stress (V _{DD} = 28 Vdc, P _{out} = 60 W CW, I _{DQ} = 500 mA, f = 2110 MHz, VSWR = 10:1, All Phase Angles at Frequency of Tests)	Ψ	No Degradation In Output Power Before and After Test			

(1) Part is internally matched both on input and output.

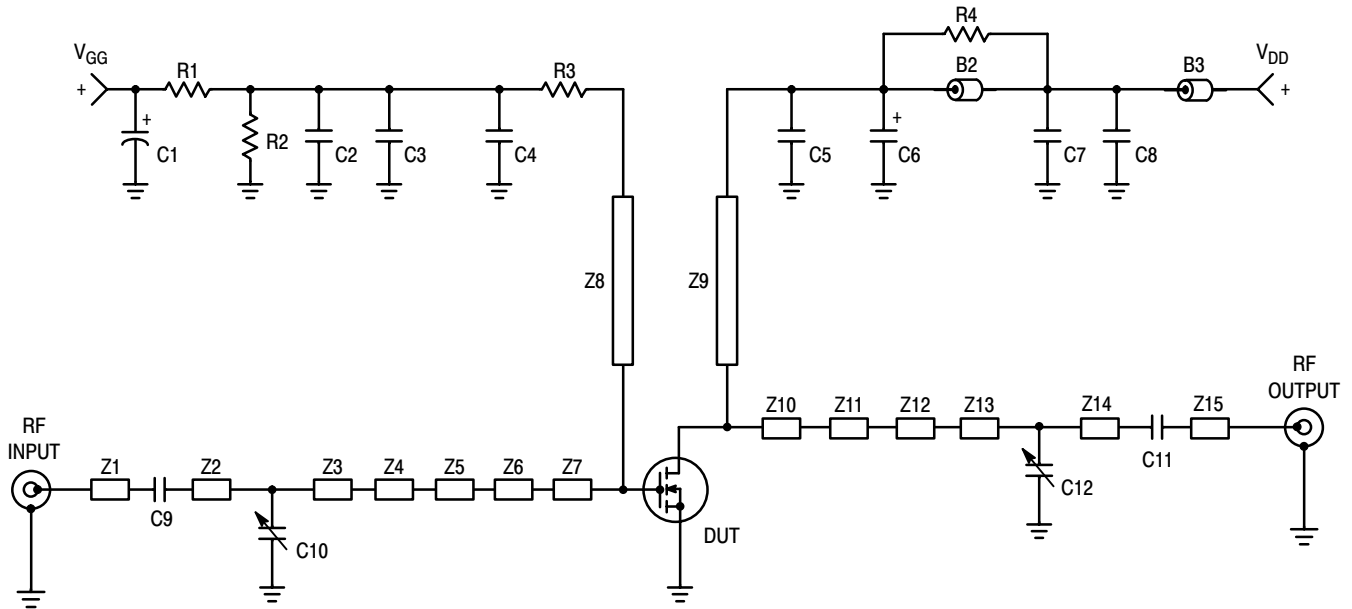

B2 - B3	Ferrite Beads, Fair Rite #2743019447	Z3	0.180" x 0.100" Microstrip
C1	10 μ F, 50 V Electrolytic Chip Capacitor, Panasonic #ECEV1HV100R	Z4	0.152" x 0.293" Microstrip
C2, C7	1000 pF Chip Capacitors, ATC #100B102JCA500X	Z5	0.216" x 0.100" Microstrip
C3, C8	0.10 μ F Chip Capacitors, Kemet #CDR33BX104AKWS	Z6	0.114" x 0.410" Microstrip
C4, C5	4.7 pF Chip Capacitors, ATC #100B4R7JCA500X	Z7	0.626" x 0.872" Microstrip
C6	22 μ F, 35 V Tantalum Surface Mount Chip Capacitor, Sprague	Z8	1.050" x 0.050" Microstrip
C9, C11	9.1 pF Chip Capacitors, ATC #100B9R1JCA500X	Z9	0.830" x 0.050" Microstrip
C10	0.8 pF - 8.0 pF Variable Capacitor, Johanson Gigatrim	Z10	0.596" x 1.040" Microstrip
C12	0.4 pF - 4.5 pF Variable Capacitor, Johanson Gigatrim	Z11	0.186" x 0.315" Microstrip
R1	1 k Ω , 1/4 W Fixed Film Chip Resistor, 0.08" x 0.13"	Z12	0.097" x 0.525" Microstrip
R2	560 k Ω , 1/4 W Fixed Film Chip Resistor, 0.08" x 0.13"	Z13	0.353" x 0.138" Microstrip
R3	10 Ω , 1/4 W Fixed Film Chip Resistor, 0.08" x 0.13"	Z14	0.112" x 0.080" Microstrip
R4	10 Ω , 1/4 W Fixed Film Chip Resistor, 0.08" x 0.13"	Z15	0.722" x 0.080" Microstrip
Z1	0.743" x 0.080" Microstrip	Board	0.030" Glass Teflon [®] , Arlon GX-0300-55-22, 2 oz Cu
Z2	0.070" x 0.100" Microstrip		

Figure 1. MRF21060 Test Circuit Schematic

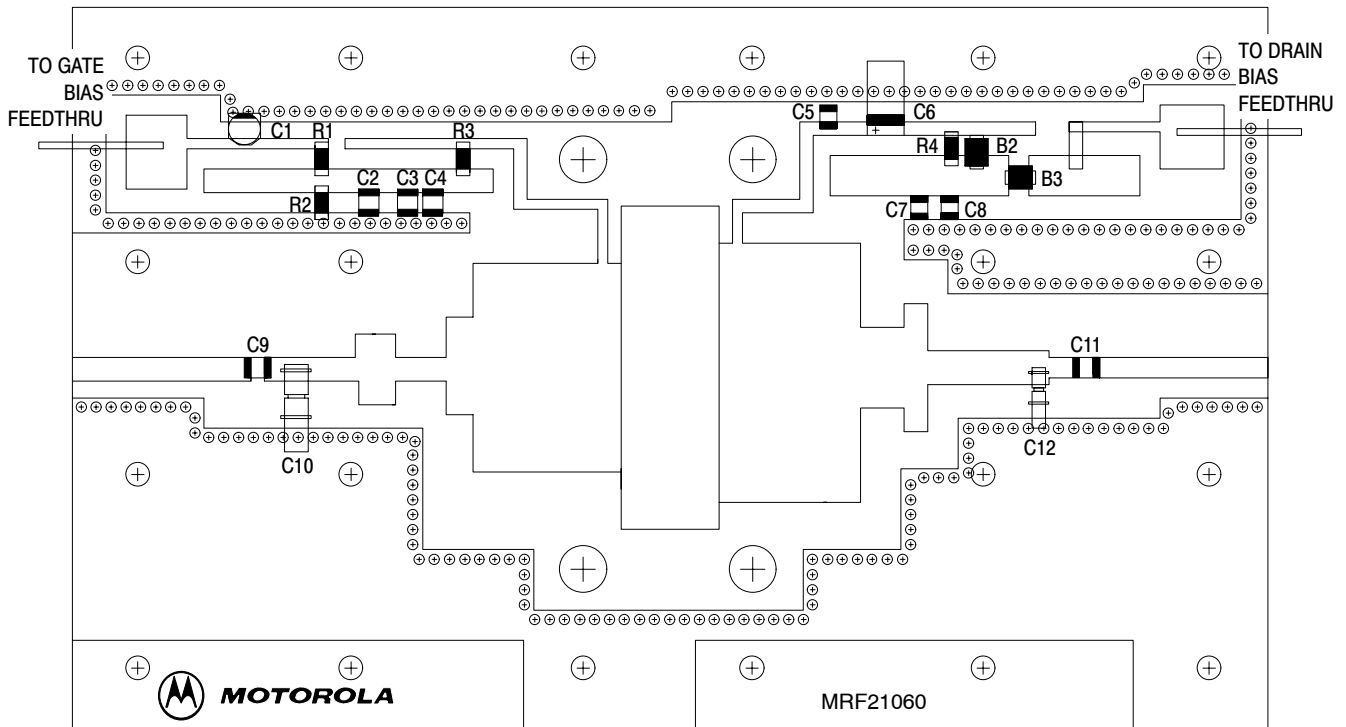

Figure 2. MRF21060 Test Circuit Component Layout

TYPICAL CHARACTERISTICS

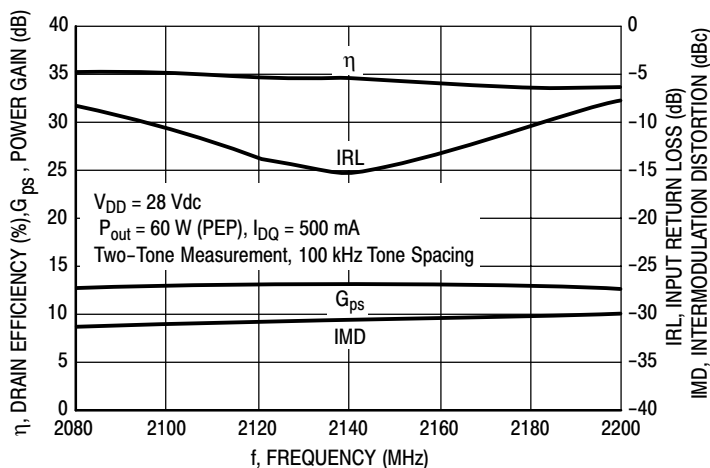

Figure 3. Class AB Broadband Circuit Performance

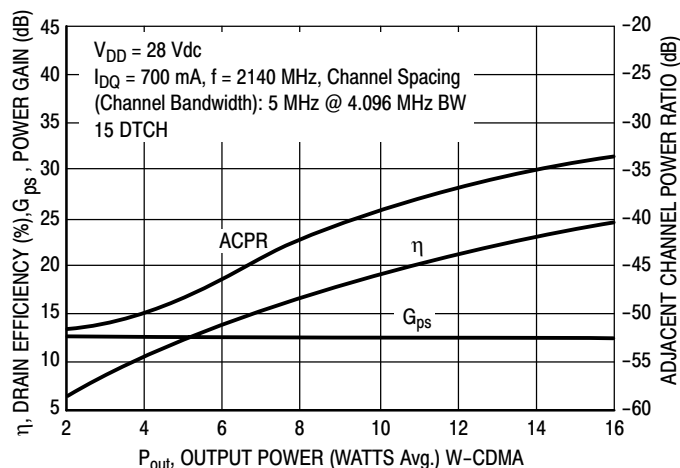

Figure 4. W-CDMA ACPR, Power Gain and Drain Efficiency versus Output Power

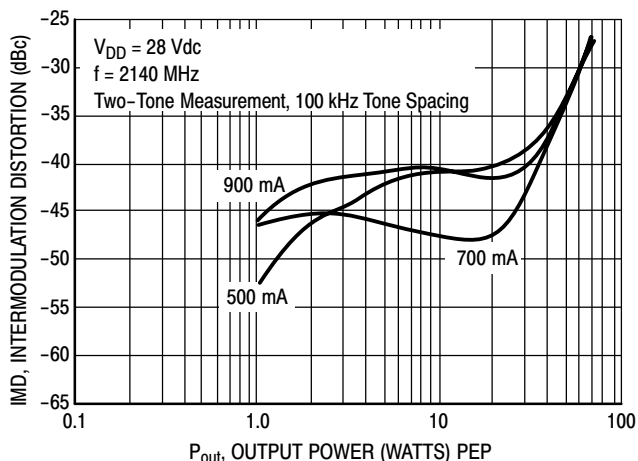

Figure 5. Intermodulation Distortion versus Output Power

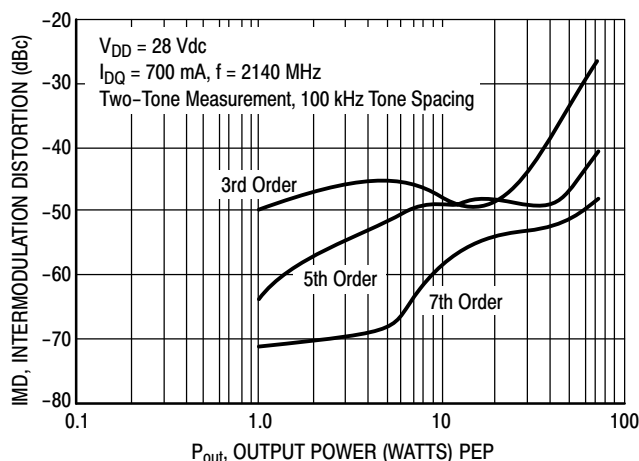

Figure 6. Intermodulation Distortion Products versus Output Power

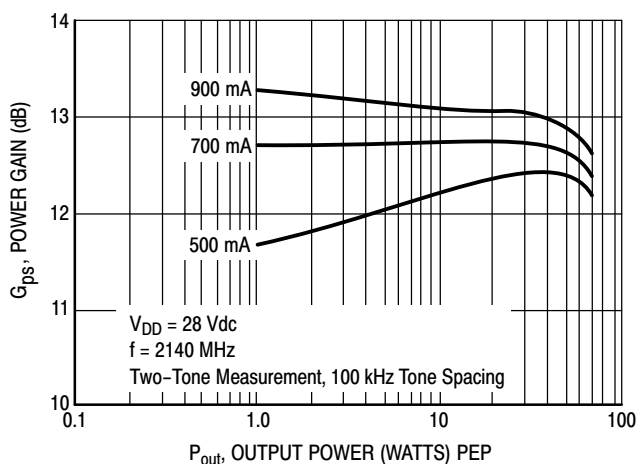

Figure 7. Power Gain versus Output Power

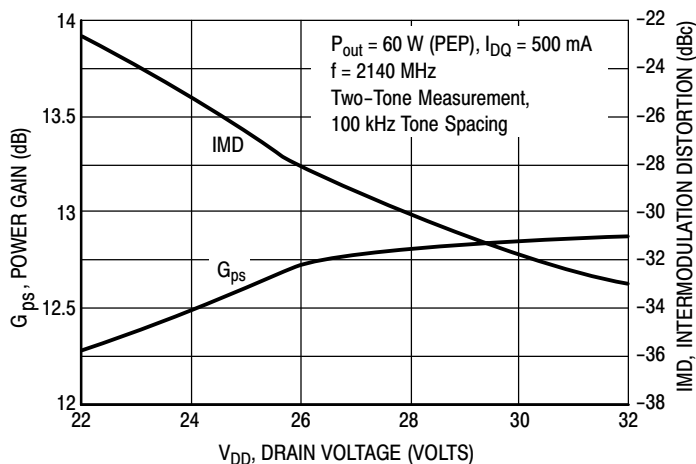
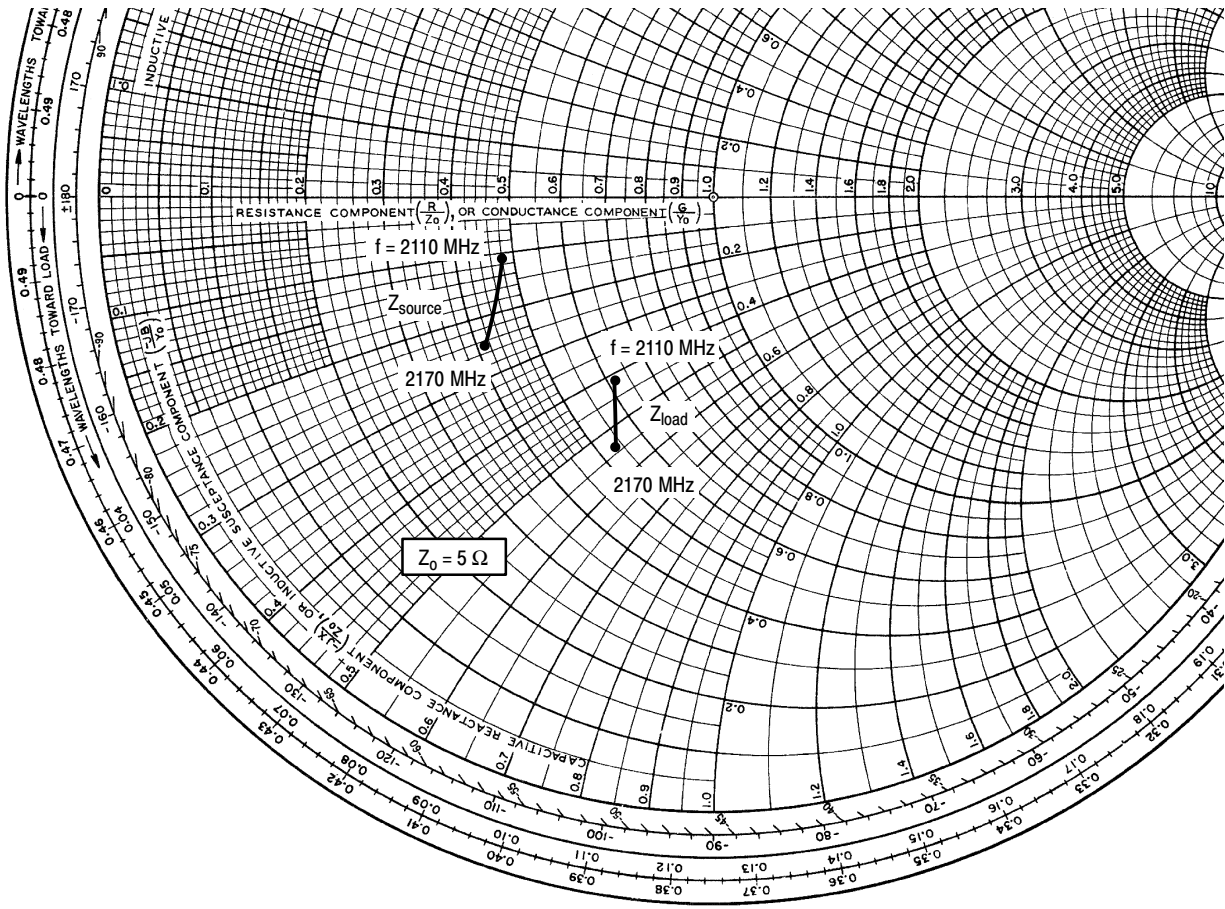

Figure 8. Power Gain and Intermodulation Distortion versus Supply Voltage



$V_{DD} = 28\text{ V}$, $I_{DQ} = 500\text{ mA}$, $P_{out} = 60\text{ W PEP}$

f MHz	Z_{source} Ω	Z_{load} Ω
2110	$2.40 - j0.55$	$3.07 - j2.05$
2140	$2.26 - j0.87$	$2.89 - j2.38$
2170	$2.08 - j1.23$	$2.66 - j2.71$

Z_{source} = Test circuit impedance as measured from gate to ground.

Z_{load} = Test circuit impedance as measured from drain to ground.

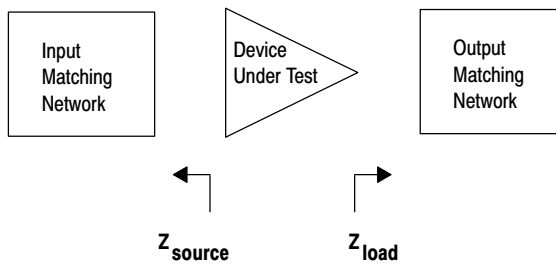
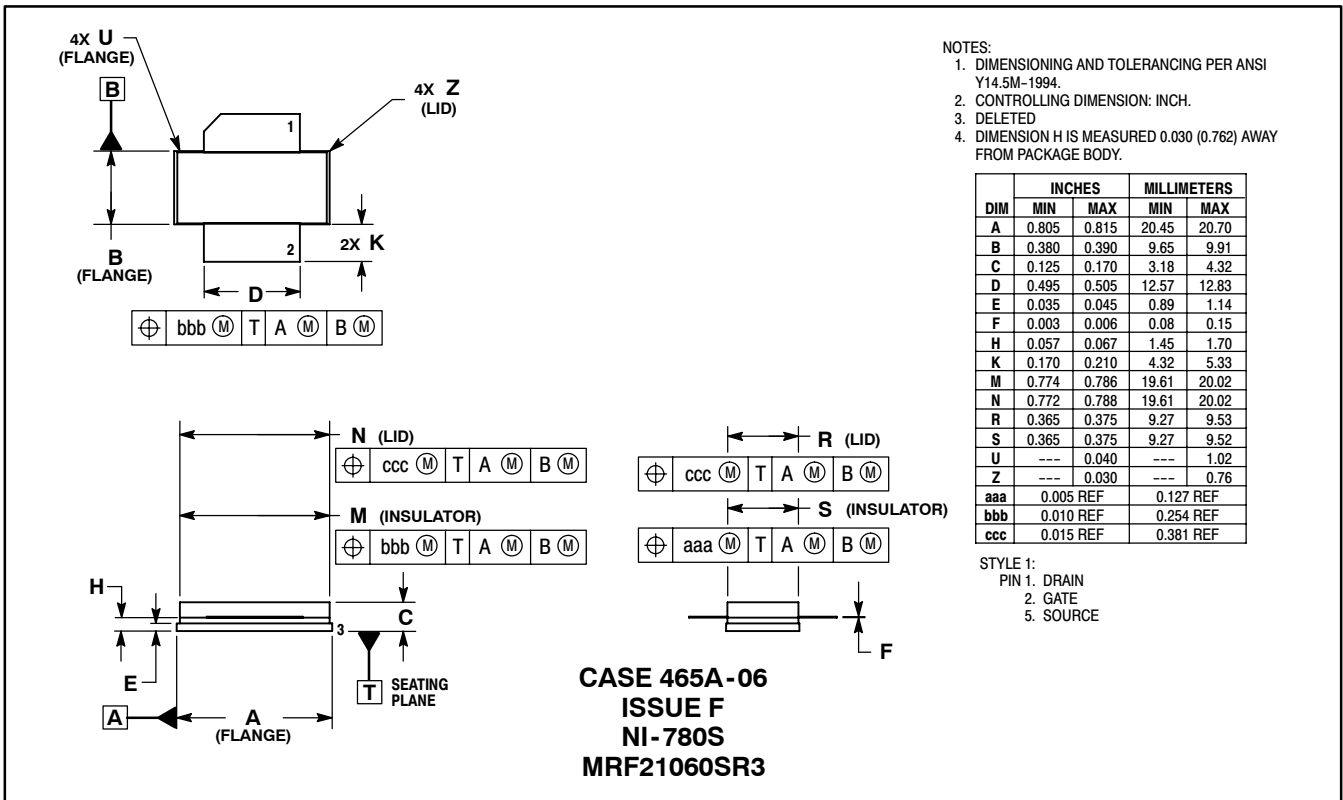
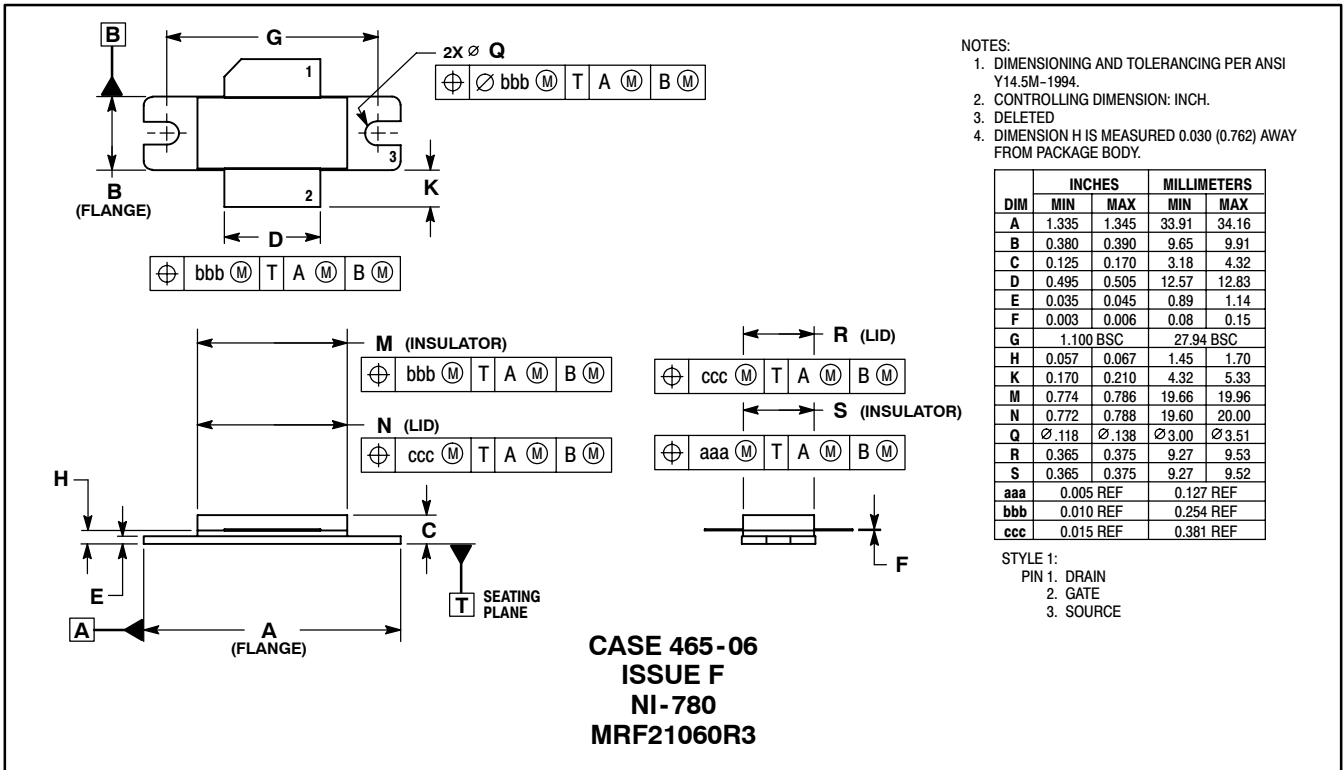

Figure 9. Series Equivalent Source and Load Impedance

Freescale Semiconductor, Inc.

PACKAGE DIMENSIONS



Information in this document is provided solely to enable system and software implementers to use Motorola products. There are no express or implied copyright licenses granted hereunder to design or fabricate any integrated circuits or integrated circuits based on the information in this document.

Motorola reserves the right to make changes without further notice to any products herein. Motorola makes no warranty, representation or guarantee regarding the suitability of its products for any particular purpose, nor does Motorola assume any liability arising out of the application or use of any product or circuit, and specifically disclaims any and all liability, including without limitation consequential or incidental damages. "Typical" parameters that may be provided in Motorola data sheets and/or specifications can and do vary in different applications and actual performance may vary over time. All operating parameters, including "Typicals", must be validated for each customer application by customer's technical experts. Motorola does not convey any license under its patent rights nor the rights of others. Motorola products are not designed, intended, or authorized for use as components in systems intended for surgical implant into the body, or other applications intended to support or sustain life, or for any other application in which the failure of the Motorola product could create a situation where personal injury or death may occur. Should Buyer purchase or use Motorola products for any such unintended or unauthorized application, Buyer shall indemnify and hold Motorola and its officers, employees, subsidiaries, affiliates, and distributors harmless against all claims, costs, damages, and expenses, and reasonable attorney fees arising out of, directly or indirectly, any claim of personal injury or death associated with such unintended or unauthorized use, even if such claim alleges that Motorola was negligent regarding the design or manufacture of the part.

MOTOROLA and the Stylized M Logo are registered in the US Patent and Trademark Office. All other product or service names are the property of their respective owners. Motorola, Inc. is an Equal Opportunity/Affirmative Action Employer.

© Motorola Inc. 2004

HOW TO REACH US:

USA/EUROPE/LOCATIONS NOT LISTED:
Motorola Literature Distribution
P.O. Box 5405, Denver, Colorado 80217
1-800-521-6274 or 480-768-2130

JAPAN: Motorola Japan Ltd.; SPS, Technical Information Center,
3-20-1, Minami-Azabu, Minato-ku, Tokyo 106-8573, Japan
81-3-3440-3569

ASIA/PACIFIC: Motorola Semiconductors H.K. Ltd.; Silicon Harbour Centre,
2 Dai King Street, Tai Po Industrial Estate, Tai Po, N.T., Hong Kong
852-26668334

HOME PAGE: <http://motorola.com/semiconductors>



◇ **For More Information On This Product,
Go to: www.freescale.com**

MRF21060/D