

**VOLTAGE RANGE: 50 - 400V**  
**CURRENT: 8.0 A**

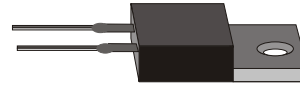

### Features

- Low Leakage
- Low Forward Voltage Drop
- High Current Capability
- Super-fast Switching Speed < 35ns
- Plastic Material - UL Flammability Classification 94V-0
- Good for 200KHz Power Supplier

### Mechanical Data

- Case: TO-220, Molded Plastic
- Terminals: Plated Axial Leads, Solderable per MIL-STD-202 Method 208
- Approx Weight: 2.24 grams
- Mounting Position: Any

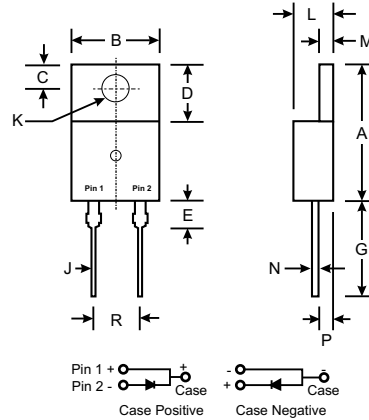

TO-220		
Dim	Min	Max
A	14.22	15.88
B	9.65	10.67
C	2.54	3.43
D	5.84	6.86
E	—	6.25
G	12.70	14.73
H	2.29	2.79
J	0.51	1.14
K	3.53Ø	4.09Ø
L	3.56	4.83
M	1.14	1.40
N	0.30	0.64
P	2.03	2.92
R	4.83	5.33
All Dimensions in mm		

### Maximum Ratings and Electrical Characteristics T<sub>A</sub> = 25°C unless otherwise specified

Single phase, half wave, 60Hz, resistive or inductive load. For capacitive load, derate current by 20%.

Characteristic	Symbol	SF81	SF82	SF83	SF84	SF85	SF86	Unit
Maximum Repetitive Peak Reverse Voltage	V <sub>RRM</sub>	50	100	150	200	300	400	Volts
Maximum RMS Voltage	V <sub>RMS</sub>	35	70	105	140	210	280	Volts
Maximum DC Blocking Voltage	V <sub>DC</sub>	50	100	150	200	300	400	Volts
Maximum Average Forward Rectified Current At T <sub>C</sub> =105	I <sub>(AV)</sub>	8.0						Amps
Peak Forward Surge Current 8.3ms single half sine wave superimposed on rated load (JEDEC method)	I <sub>FSM</sub>	125						
Maximum Instantaneous Forward Voltage at 8.0A	V <sub>F</sub>	0.975			1.4			
Maximum DC Reverse Current at rated DC Blocking Voltage	I <sub>R</sub>	10						µA
		500						
Maximum Reverse Recovery Time Test conditions I <sub>F</sub> =0.5A, I <sub>R</sub> =1.0A I <sub>RR</sub> =0.25A	t <sub>rr</sub>	35			50		nS	
Typical Junction Capacitance (Note 2)	C <sub>J</sub>	40						pF
Typical Thermal Resistance (Note 1)	R <sub>θJC</sub>	2.5						/W
Operating Junction Temperature Range	T <sub>J</sub>	(-55 to +150)						
Storage Temperature Range	T <sub>STG</sub>	(-55 to +150)						

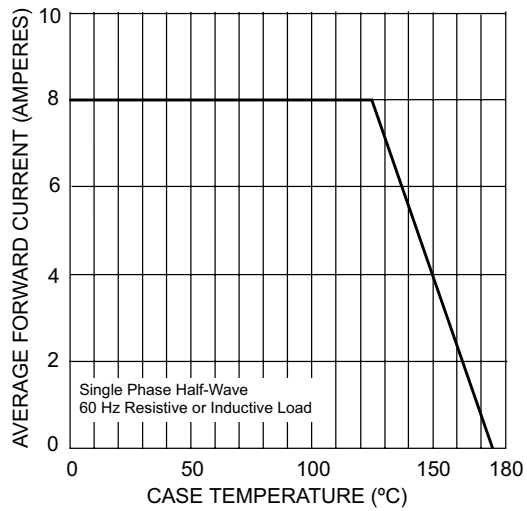

Fig. 1 Forward Current Derating Curve

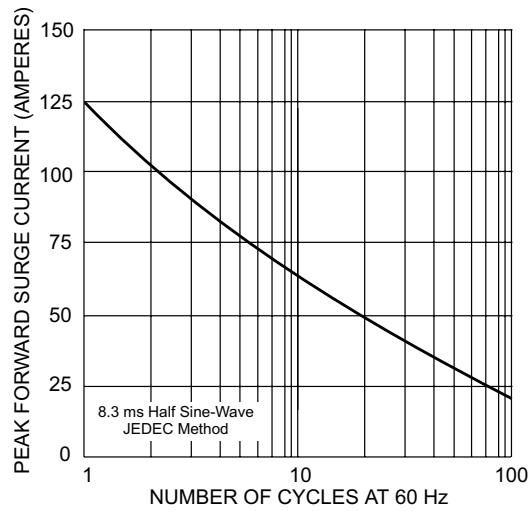

Fig. 2 Maximum Non-Repetitive Surge Current

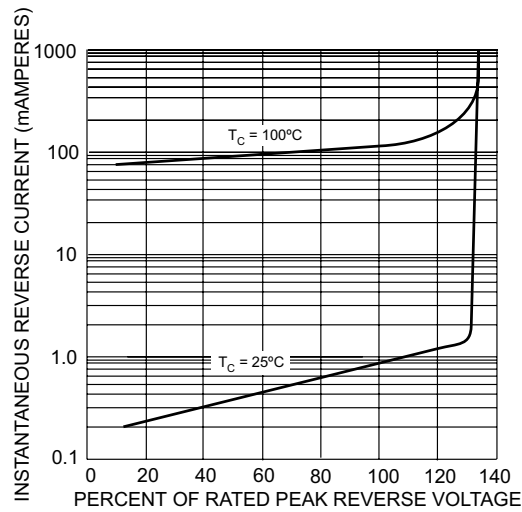

Fig. 3 Typical Reverse Characteristics

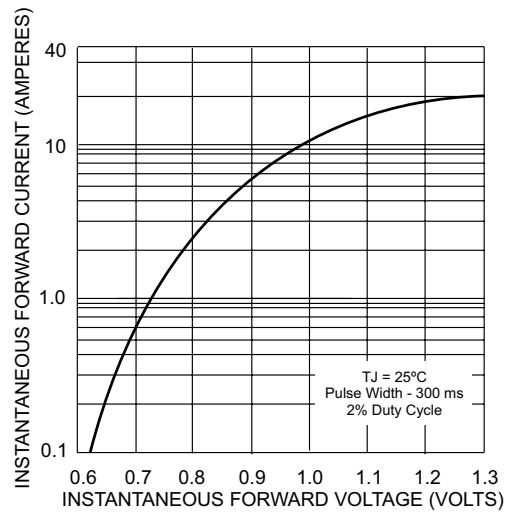

Fig. 4 Typical Instantaneous Forward Characteristics

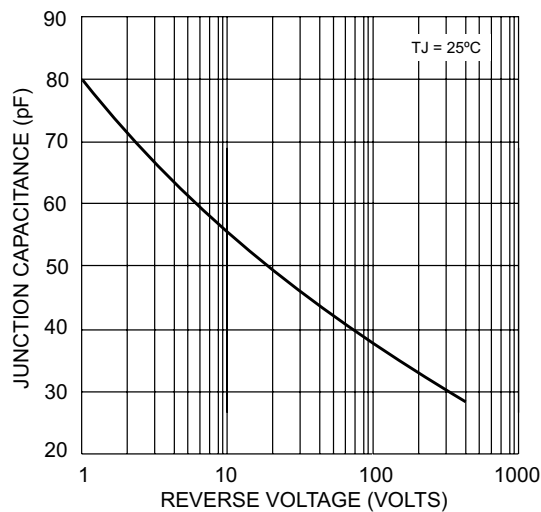

Fig. 5 Typical Junction Capacitance