

REF20xx Low-Drift, Low-Power, Dual-Output, V_{REF} and $V_{REF} / 2$ Voltage References

1 Features

- Two Outputs, V_{REF} and $V_{REF} / 2$, for Convenient Use in Single-Supply Systems
- Excellent Temperature Drift Performance:
 - 8 ppm/°C (max) from –40°C to 125°C
- High Initial Accuracy: $\pm 0.05\%$ (max)
- V_{REF} and V_{BIAS} Tracking over Temperature:
 - 6 ppm/°C (max) from –40°C to 85°C
 - 7 ppm/°C (max) from –40°C to 125°C
- Microsize Package: SOT23-5
- Low Dropout Voltage: 10 mV
- High Output Current: ± 20 mA
- Low Quiescent Current: 360 μ A
- Line Regulation: 3 ppm/V
- Load Regulation: 8 ppm/mA

2 Applications

- Digital Signal Processing:
 - Power Inverters
 - Motor Controls
- Current Sensing
- Industrial Process Controls
- Medical Equipment
- Data Acquisition Systems
- Single-Supply Systems

3 Description

Applications with only a positive supply voltage often require additional stable voltage in the middle of the analog-to-digital converter (ADC) input range to bias input bipolar signals. The REF20xx provides a reference voltage (V_{REF}) for the ADC and a second highly-accurate voltage (V_{BIAS}) that can be used to bias the input bipolar signals.

The REF20xx offers excellent temperature drift (8 ppm/°C, max) and initial accuracy (0.05%) on both the V_{REF} and V_{BIAS} outputs while operating at a quiescent current less than 430 μ A. In addition, the V_{REF} and V_{BIAS} outputs track each other with a precision of 6 ppm/°C (max) across the temperature range of –40°C to 85°C. All these features increase the precision of the signal chain and decrease board space, while reducing the cost of the system as compared to a discrete solution. Extremely low dropout voltage of only 10 mV allows operation from very low input voltages, which can be very useful in battery-operated systems.

Both the V_{REF} and V_{BIAS} voltages have the same excellent specifications and can sink and source current equally well. Very good long-term stability and low noise levels make these devices ideally-suited for high-precision industrial applications.

Device Information⁽¹⁾

PART NAME	PACKAGE	BODY SIZE (NOM)
REF20xx	SOT (5)	2.90 mm x 1.60 mm

(1) For all available packages, see the orderable addendum at the end of the datasheet.

Application Example

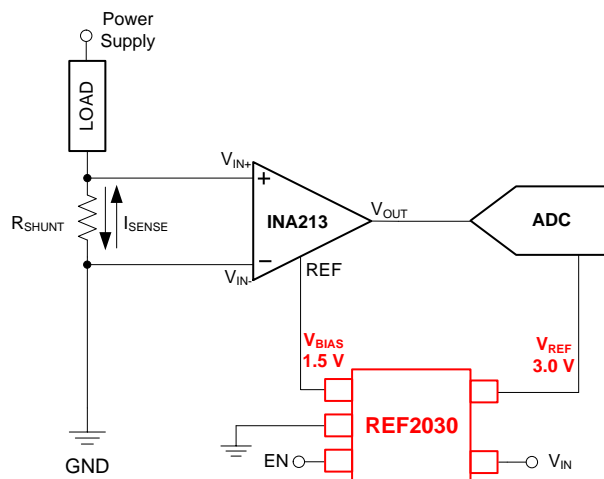

V_{REF} and V_{BIAS} vs Temperature

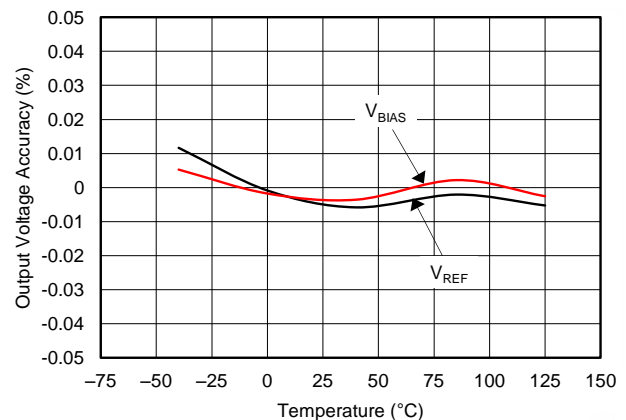

Table of Contents

1 Features	1	9.1 Overview	16
2 Applications	1	9.2 Functional Block Diagram	16
3 Description	1	9.3 Feature Description	16
4 Revision History	2	9.4 Device Functional Modes	17
5 Device Comparison Table	3	10 Applications and Implementation	18
6 Pin Configuration and Functions	3	10.1 Application Information	18
7 Specifications	4	10.2 Typical Application	18
7.1 Absolute Maximum Ratings	4	11 Power-Supply Recommendations	23
7.2 Handling Ratings	4	12 Layout	24
7.3 Recommended Operating Conditions	4	12.1 Layout Guidelines	24
7.4 Thermal Information	4	12.2 Layout Example	24
7.5 Electrical Characteristics	5	13 Device and Documentation Support	25
7.6 Typical Characteristics	6	13.1 Documentation Support	25
8 Parameter Measurement Information	13	13.2 Related Links	25
8.1 Solder Heat Shift	13	13.3 Trademarks	25
8.2 Thermal Hysteresis	14	13.4 Electrostatic Discharge Caution	25
8.3 Noise Performance	15	13.5 Glossary	25
9 Detailed Description	16	14 Mechanical, Packaging, and Orderable Information	25

4 Revision History

Changes from Revision A (June 2014) to Revision B	Page
• Changed device status to Production Data from Mixed Status	1
• Deleted footnote 2 from Device Information table	1
• Deleted footnote from Device Comparison Table	3
• Added Thermal Information table	4

Changes from Original (May 2014) to Revision A	Page
• Made changes to product preview data sheet	1

5 Device Comparison Table

PRODUCT	V_{REF}	V_{BIAS}
REF2025	2.5 V	1.25 V
REF2030	3.0 V	1.5 V
REF2033	3.3 V	1.65 V
REF2041	4.096 V	2.048 V

6 Pin Configuration and Functions

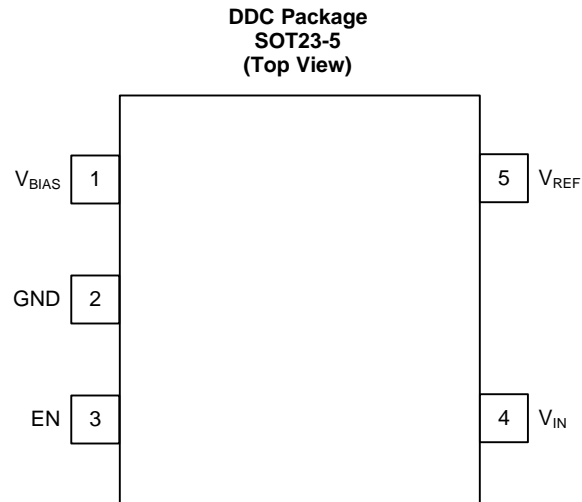

Pin Functions

PIN		DESCRIPTION
NO.	NAME	
1	V_{BIAS}	Bias voltage output ($V_{REF} / 2$)
2	GND	Ground
3	EN	Enable ($EN \geq V_{IN} - 0.7$ V, device enabled)
4	V_{IN}	Input supply voltage
5	V_{REF}	Reference voltage output (V_{REF})

7 Specifications

7.1 Absolute Maximum Ratings

over operating free-air temperature range (unless otherwise noted)⁽¹⁾

		MIN	MAX	UNIT
Input voltage	V _{IN}	-0.3	6	V
	EN	-0.3	V _{IN} + 0.3	V
Temperature	Operating temperature range	-55	150	°C
	Junction Temperature, T _J		150	°C

- (1) Stresses beyond those listed under *Absolute Maximum Ratings* may cause permanent damage to the device. These are stress ratings only, which do not imply functional operation of the device at these or any other conditions beyond those indicated under *Recommended Operating Conditions*. Exposure to absolute-maximum-rated conditions for extended periods may affect device reliability.

7.2 Handling Ratings

			MIN	MAX	UNIT
T _{stg}	Storage temperature range		-65	170	°C
V _(ESD)	Electrostatic discharge	Human body model (HBM), per ANSI/ESDA/JEDEC JS-001, all pins ⁽¹⁾	-4000	4000	V
		Charged device model (CDM), per JEDEC specification JESD22-C101, all pins ⁽²⁾	-1500	1500	

- (1) JEDEC document JEP155 states that 500-V HBM allows safe manufacturing with a standard ESD control process.
 (2) JEDEC document JEP157 states that 250-V CDM allows safe manufacturing with a standard ESD control process.

7.3 Recommended Operating Conditions

over operating free-air temperature range (unless otherwise noted)

		MIN	NOM	MAX	UNIT
V _{IN}	Supply input voltage range (I _L = 0 mA, T _A = 25°C)	V _{REF} + 0.02 ⁽¹⁾		5.5	V

- (1) Please refer to [Figure 28](#) in [Typical Characteristics](#) for minimum input voltage at different load currents and temperature

7.4 Thermal Information

THERMAL METRIC ⁽¹⁾		REF20xx	UNIT
		DDC (SOT23)	
		5 PINS	
R _{θJA}	Junction-to-ambient thermal resistance	193.6	°C/W
R _{θJC(top)}	Junction-to-case (top) thermal resistance	40.2	
R _{θJB}	Junction-to-board thermal resistance	34.5	
Ψ _{JT}	Junction-to-top characterization parameter	0.9	
Ψ _{JB}	Junction-to-board characterization parameter	34.3	
R _{θJC(bot)}	Junction-to-case (bottom) thermal resistance	N/A	

- (1) For more information about traditional and new thermal metrics, see the *IC Package Thermal Metrics* application report, [SPRA953](#).

7.5 Electrical Characteristics

At $T_A = 25^\circ\text{C}$, $I_L = 0\text{ mA}$, and $V_{IN} = 5\text{ V}$, unless otherwise noted. Both V_{REF} and V_{BIAS} have the same specifications.

PARAMETER		TEST CONDITIONS	MIN	TYP	MAX	UNIT
ACCURACY AND DRIFT						
Output voltage accuracy			-0.05%		0.05%	
Output voltage temperature coefficient ⁽¹⁾		$-40^\circ\text{C} \leq T_A \leq 125^\circ\text{C}$		± 3	± 8	ppm/ $^\circ\text{C}$
V_{REF} and V_{BIAS} tracking over temperature ⁽²⁾		$-40^\circ\text{C} \leq T_A \leq 85^\circ\text{C}$		± 1.5	± 6	ppm/ $^\circ\text{C}$
		$-40^\circ\text{C} \leq T_A \leq 125^\circ\text{C}$		± 2	± 7	ppm/ $^\circ\text{C}$
LINE AND LOAD REGULATION						
$\Delta V_{O(\Delta V_I)}$	Line regulation	$V_{REF} + 0.02\text{ V} \leq V_{IN} \leq 5.5\text{ V}$		3	35	ppm/V
$\Delta V_{O(\Delta I_L)}$	Load regulation	Sourcing $0\text{ mA} \leq I_L \leq 20\text{ mA}$, $V_{REF} + 0.6\text{ V} \leq V_{IN} \leq 5.5\text{ V}$		8	20	ppm/mA
		Sinking $0\text{ mA} \leq I_L \leq -20\text{ mA}$, $V_{REF} + 0.02\text{ V} \leq V_{IN} \leq 5.5\text{ V}$		8	20	ppm/mA
POWER SUPPLY						
I_{CC}	Supply current	Active mode $-40^\circ\text{C} \leq T_A \leq 125^\circ\text{C}$		360	430	μA
					460	μA
	Enable voltage	Device in shutdown mode (EN = 0) $-40^\circ\text{C} \leq T_A \leq 125^\circ\text{C}$		0	0.7	V
				$V_{IN} - 0.7$	V_{IN}	V
	Dropout voltage	$I_L = 20\text{ mA}$		10	20	mV
					600	mV
I_{SC}	Short-circuit current			50		mA
t_{on}	Turn-on time	0.1% settling, $C_L = 1\text{ }\mu\text{F}$		500		μs
NOISE						
	Low-frequency noise ⁽³⁾	$0.1\text{ Hz} \leq f \leq 10\text{ Hz}$		12		ppm _{PP}
	Output voltage noise density	$f = 100\text{ Hz}$		0.25		ppm/ $\sqrt{\text{Hz}}$
CAPACITIVE LOAD						
	Stable output capacitor range			0	10	μF
HYSTERESIS AND LONG TERM STABILITY						
	Long-term stability	0 to 1000 hours		60		ppm
	Output voltage hysteresis ⁽⁴⁾	25°C , -40°C , 125°C , 25°C	Cycle 1	60		ppm
			Cycle 2	35		ppm

(1) Temperature drift is specified according to the box method. See the [Feature Description](#) section for more details.

(2) The V_{REF} and V_{BIAS} tracking over temperature specification is explained in more detail in the [Feature Description](#) section.

(3) The peak-to-peak noise measurement procedure is explained in more detail in the [Noise Performance](#) section.

(4) The thermal hysteresis measurement procedure is explained in more detail in the [Thermal Hysteresis](#) section.

7.6 Typical Characteristics

At $T_A = 25^\circ\text{C}$, $I_L = 0\text{ mA}$, $V_{IN} = 5\text{-V}$ power supply, $C_L = 0\text{ }\mu\text{F}$, and 2.5-V output, unless otherwise noted.

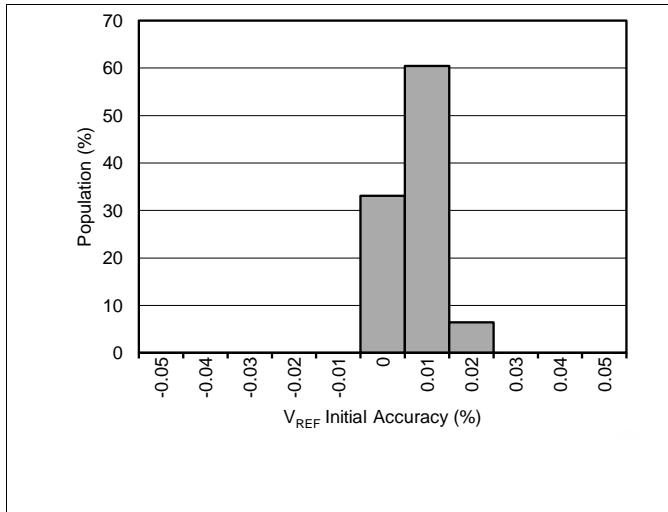

Figure 1. Initial Accuracy Distribution (V_{REF})

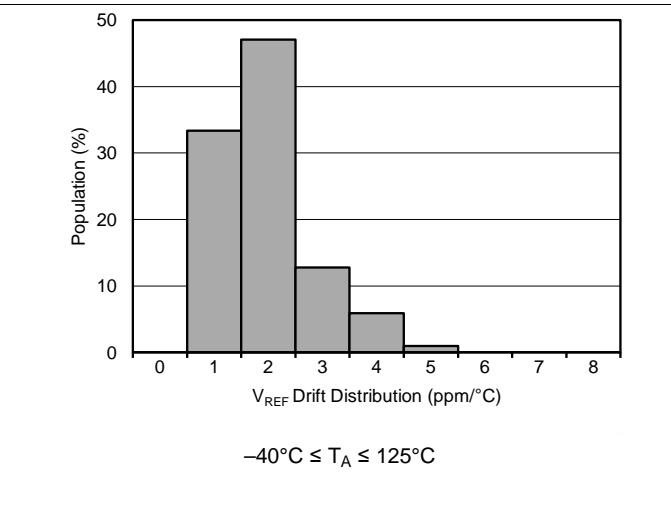

Figure 2. Drift Distribution (V_{REF})

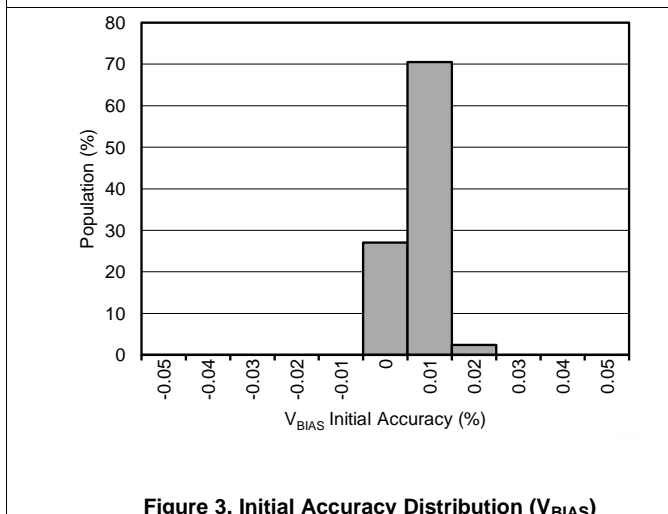

Figure 3. Initial Accuracy Distribution (V_{BIAS})

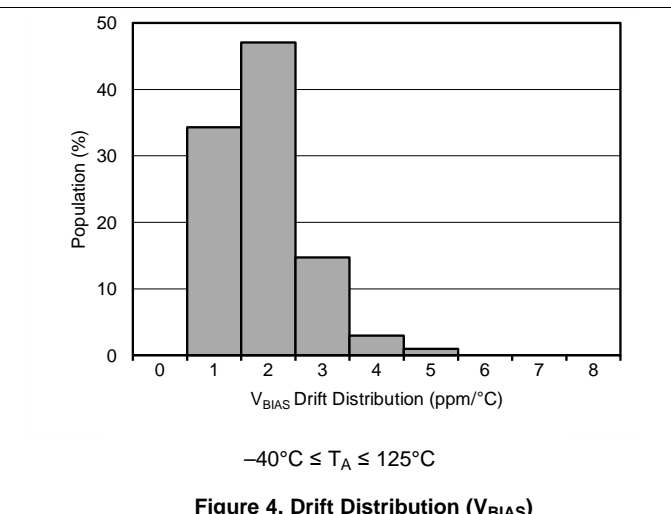

Figure 4. Drift Distribution (V_{BIAS})

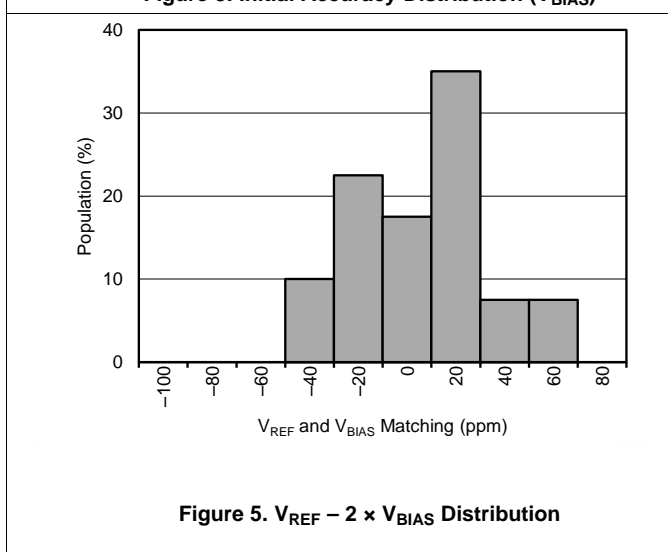

Figure 5. $V_{REF} - 2 \times V_{BIAS}$ Distribution

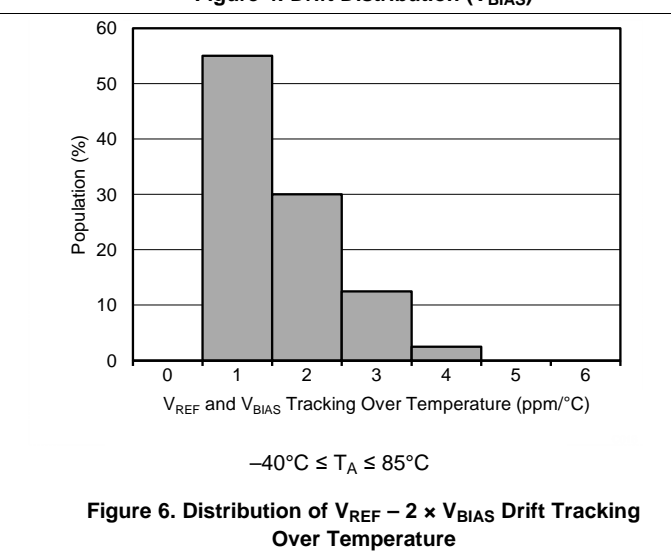
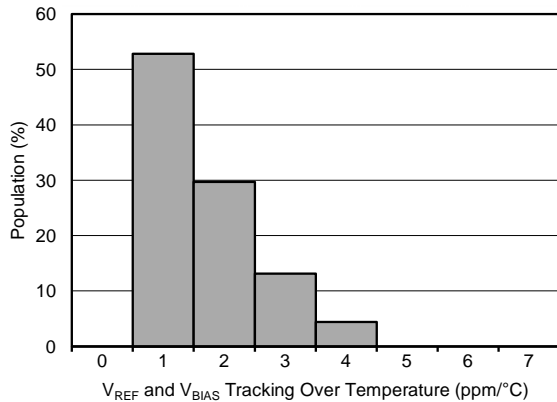

Figure 6. Distribution of $V_{REF} - 2 \times V_{BIAS}$ Drift Tracking Over Temperature

Typical Characteristics (continued)

At $T_A = 25^\circ\text{C}$, $I_L = 0\text{ mA}$, $V_{IN} = 5\text{-V power supply}$, $C_L = 0\text{ }\mu\text{F}$, and 2.5-V output , unless otherwise noted.



$-40^\circ\text{C} \leq T_A \leq 125^\circ\text{C}$

Figure 7. Distribution of $V_{REF} - 2 \times V_{BIAS}$ Drift Tracking Over Temperature

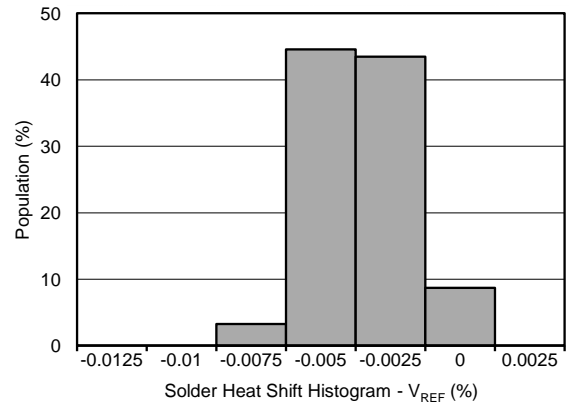

Refer to the [Solder Heat Shift](#) section for more information.

Figure 8. Solder Heat Shift Distribution (V_{REF})

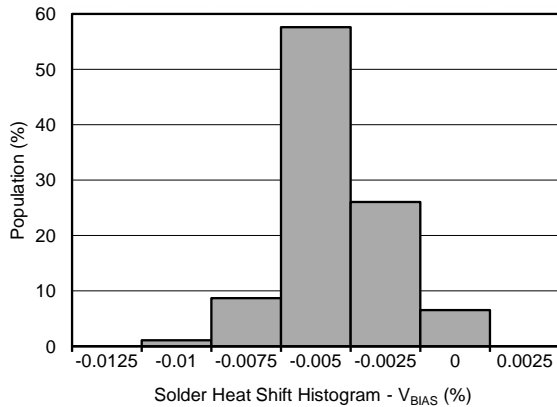

Refer to the [Solder Heat Shift](#) section for more information.

Figure 9. Solder Heat Shift Distribution (V_{BIAS})

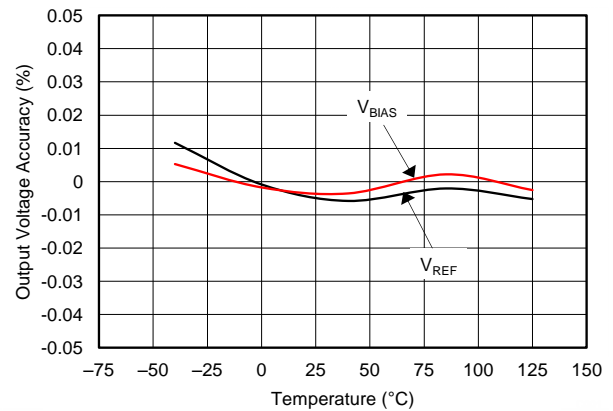

Figure 10. Output Voltage Accuracy (V_{REF}) vs Temperature

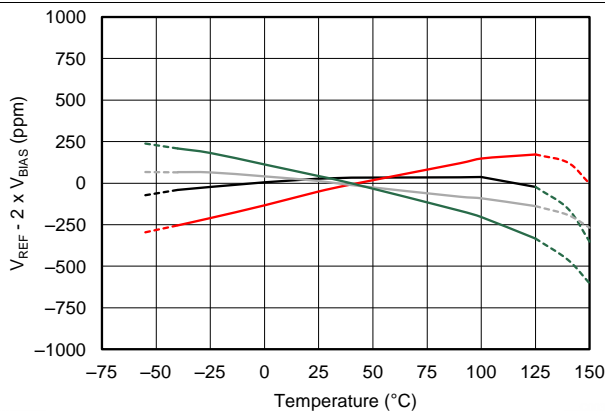

Figure 11. $V_{REF} - 2 \times V_{BIAS}$ Tracking vs Temperature

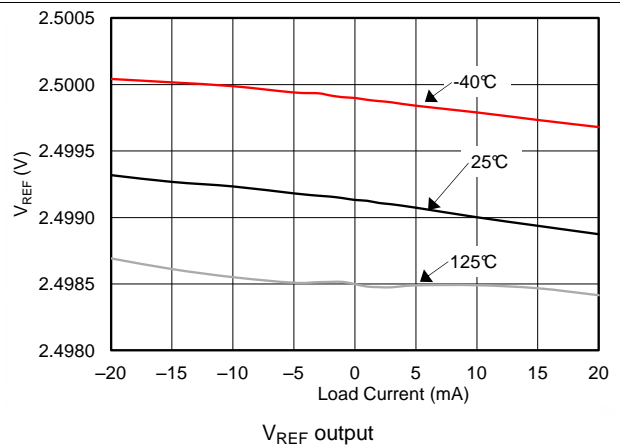

Figure 12. Output Voltage Change vs Load Current (V_{REF})

Typical Characteristics (continued)

At $T_A = 25^\circ\text{C}$, $I_L = 0\text{ mA}$, $V_{IN} = 5\text{-V}$ power supply, $C_L = 0\text{ }\mu\text{F}$, and 2.5-V output, unless otherwise noted.

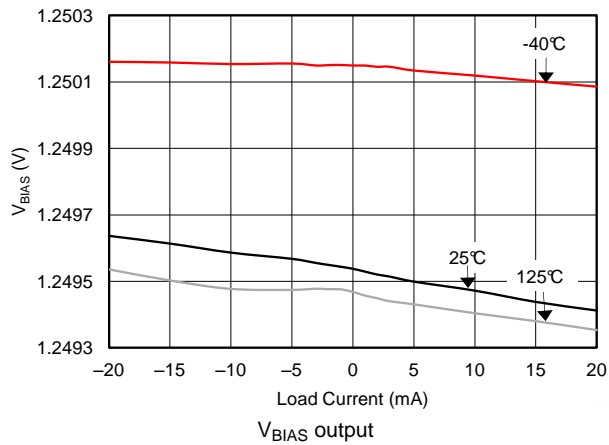

Figure 13. Output Voltage Change vs Load Current (V_{BIAS})

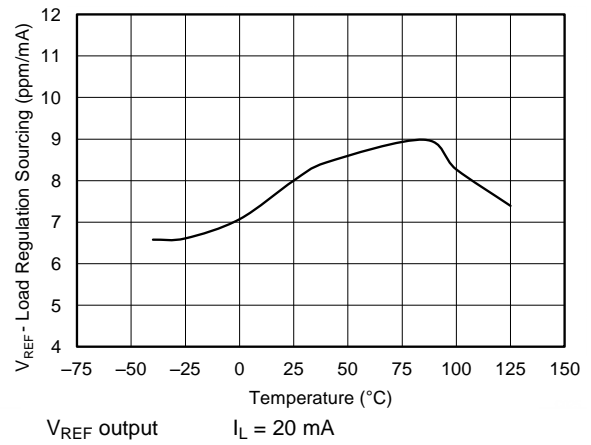

Figure 14. Load Regulation Sourcing vs Temperature (V_{REF})

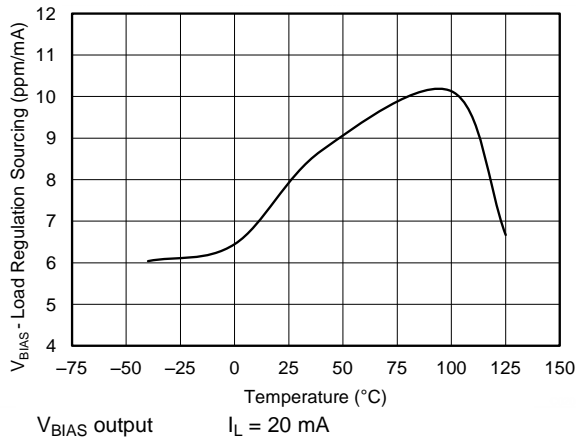

Figure 15. Load Regulation Sourcing vs Temperature (V_{BIAS})

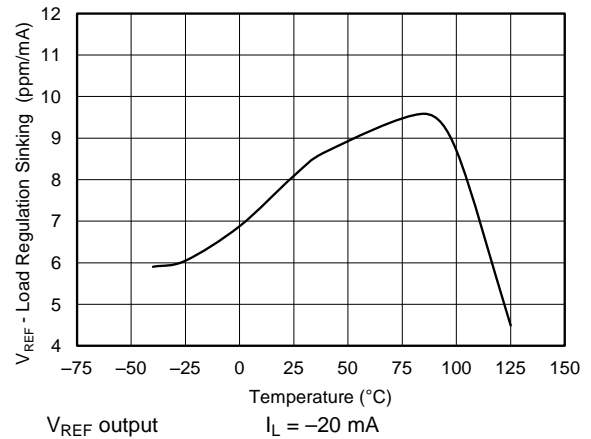

Figure 16. Load Regulation Sinking vs Temperature (V_{REF})

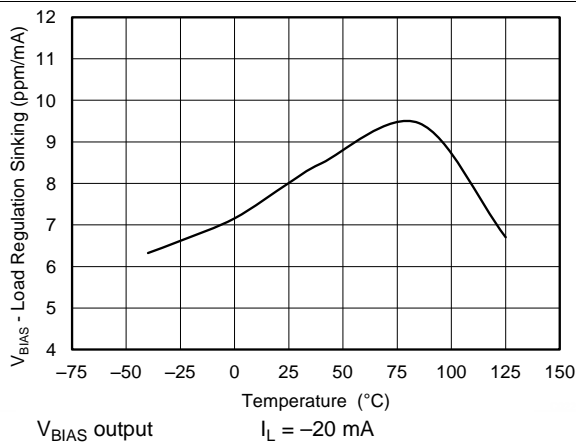

Figure 17. Load Regulation Sinking vs Temperature (V_{BIAS})

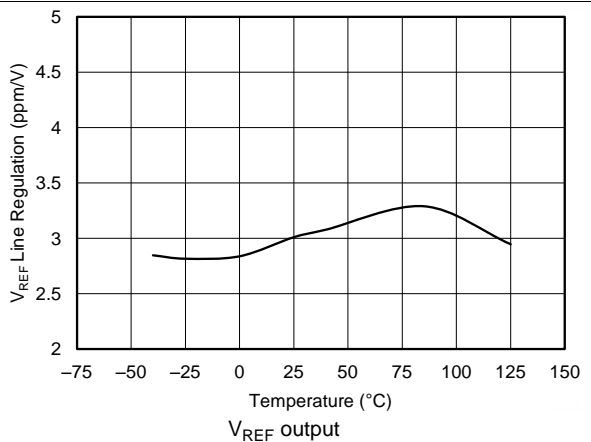

Figure 18. Line Regulation vs Temperature (V_{REF})

Typical Characteristics (continued)

At $T_A = 25^\circ\text{C}$, $I_L = 0\text{ mA}$, $V_{IN} = 5\text{-V}$ power supply, $C_L = 0\text{ }\mu\text{F}$, and 2.5-V output, unless otherwise noted.

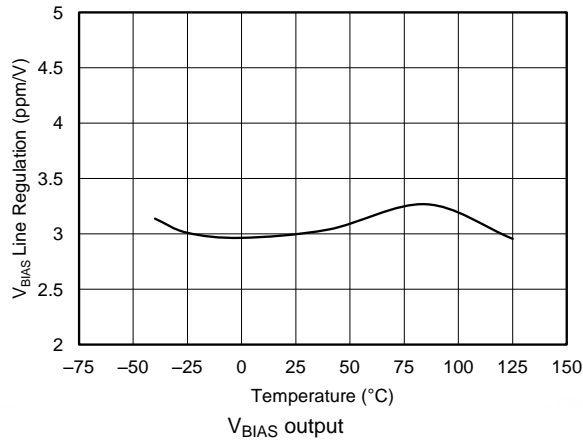

Figure 19. Line Regulation vs Temperature (V_{BIAS})

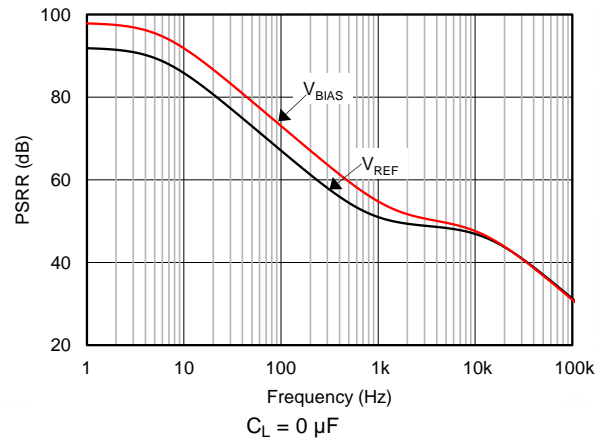

Figure 20. Power-Supply Rejection Ratio vs Frequency

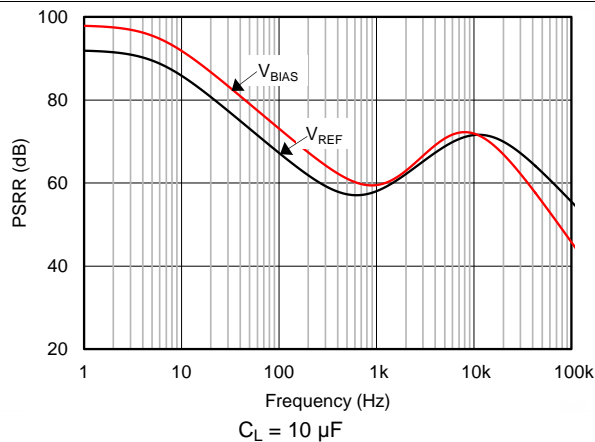

Figure 21. Power-Supply Rejection Ratio vs Frequency

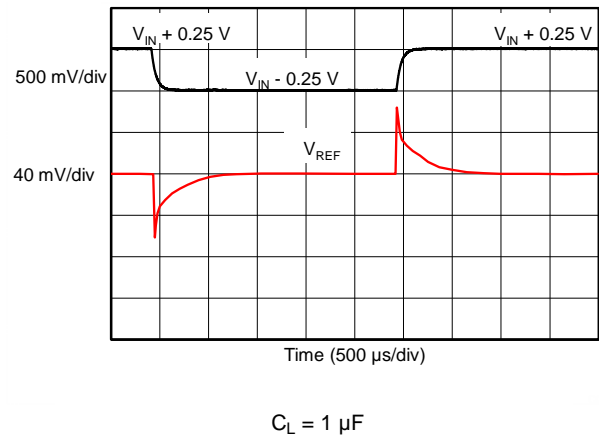

Figure 22. Line Transient Response

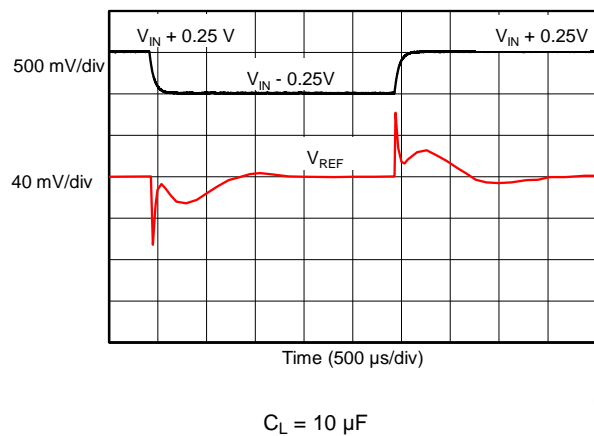

Figure 23. Line Transient Response

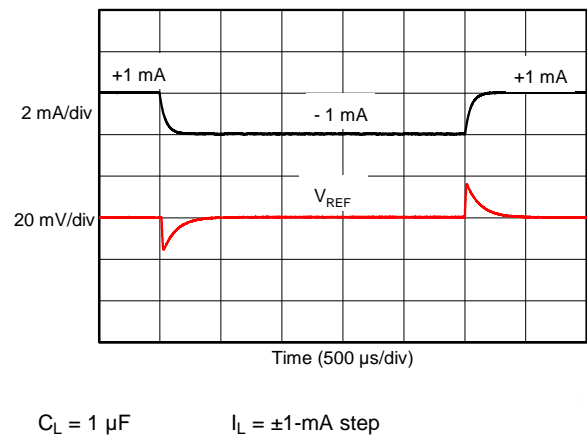
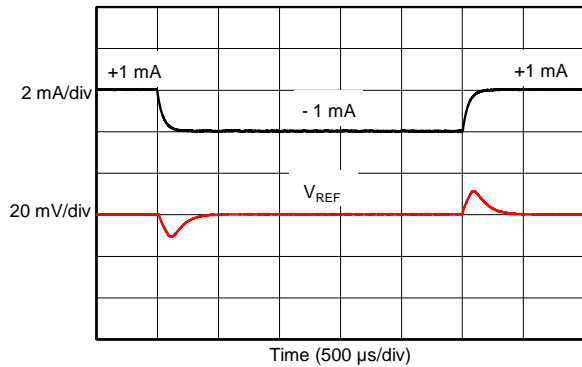

Figure 24. Load Transient Response

Typical Characteristics (continued)

At $T_A = 25^\circ\text{C}$, $I_L = 0\text{ mA}$, $V_{IN} = 5\text{-V}$ power supply, $C_L = 0\text{ }\mu\text{F}$, and 2.5-V output, unless otherwise noted.



$C_L = 10\text{ }\mu\text{F}$ $I_L = \pm 1\text{-mA}$ step

Figure 25. Load Transient Response

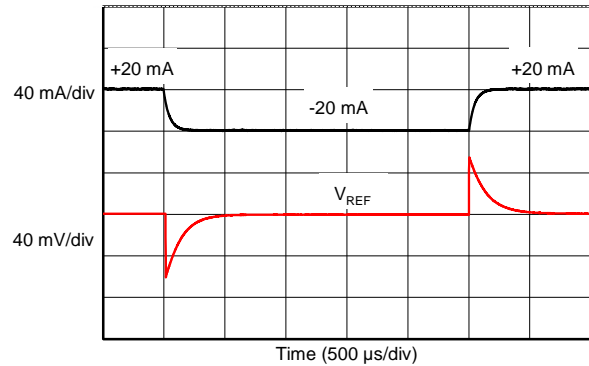

$C_L = 1\text{ }\mu\text{F}$ $I_L = \pm 20\text{-mA}$ step

Figure 26. Load Transient Response

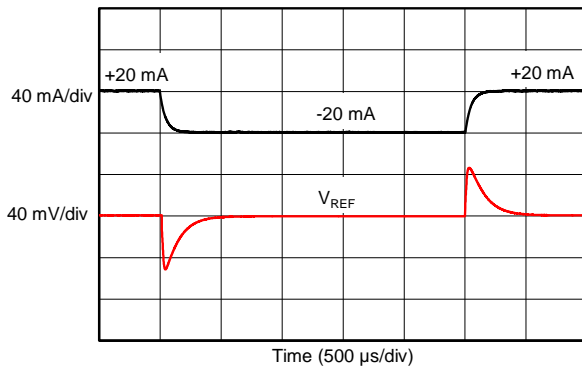

$C_L = 10\text{ }\mu\text{F}$ $I_L = \pm 20\text{-mA}$ step

Figure 27. Load Transient Response

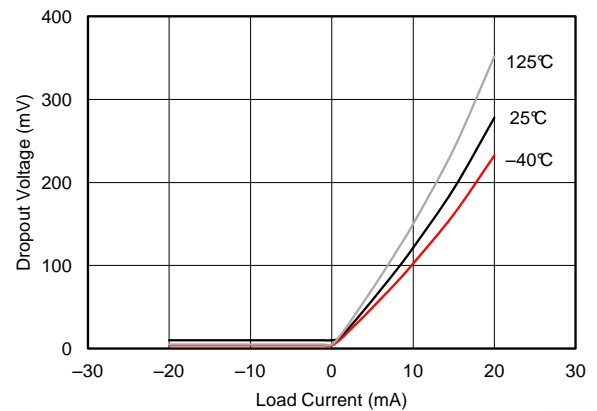
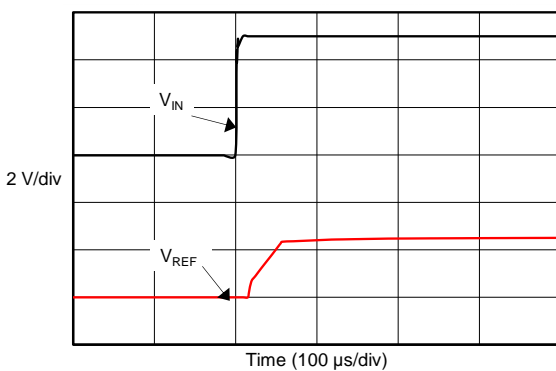
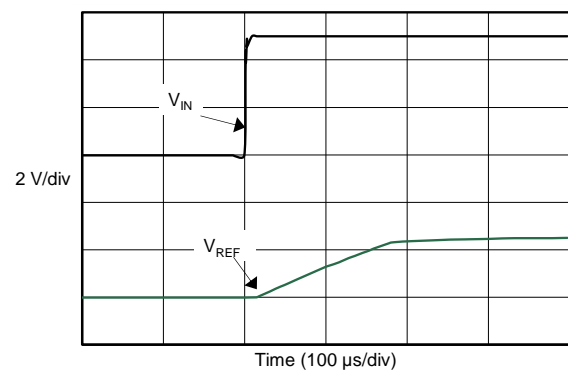

Figure 28. Minimum Dropout Voltage vs Load Current



$C_L = 1\text{ }\mu\text{F}$

Figure 29. Turn-On Settling Time



$C_L = 10\text{ }\mu\text{F}$

Figure 30. Turn-On Settling Time

Typical Characteristics (continued)

At $T_A = 25^\circ\text{C}$, $I_L = 0\text{ mA}$, $V_{IN} = 5\text{-V}$ power supply, $C_L = 0\ \mu\text{F}$, and 2.5-V output, unless otherwise noted.

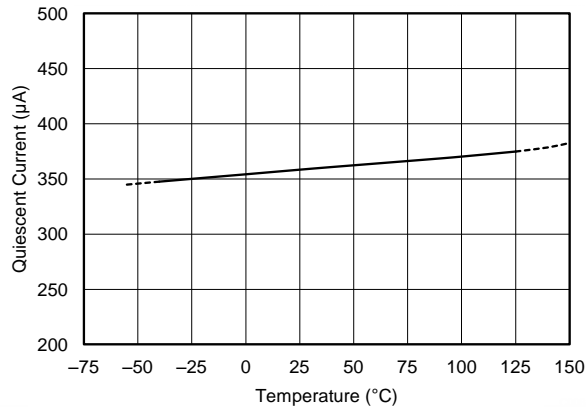

Figure 31. Quiescent Current vs Temperature

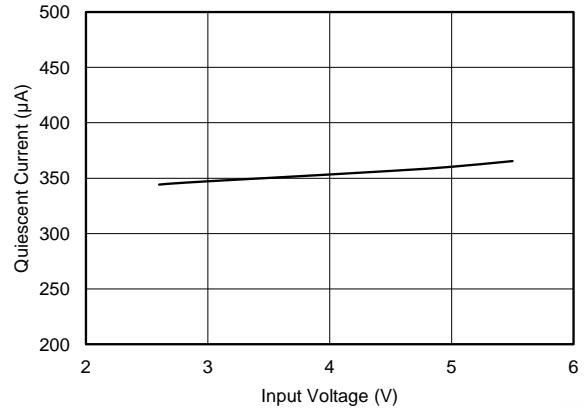
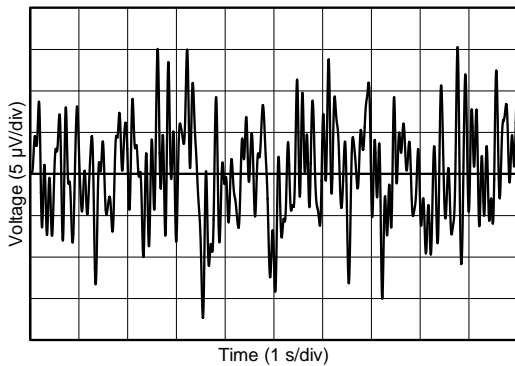
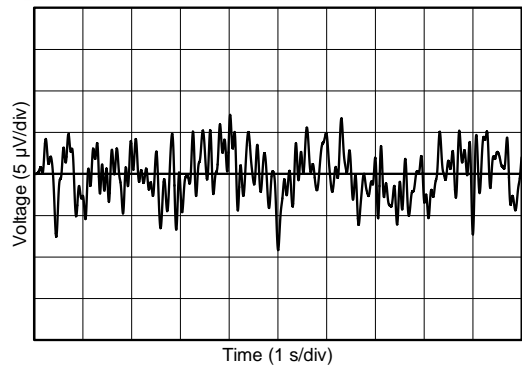

Figure 32. Quiescent Current vs Input Voltage



V_{REF} output

Figure 33. 0.1-Hz to 10-Hz Noise (V_{REF})



V_{BIAS} output

Figure 34. 0.1-Hz to 10-Hz Noise (V_{BIAS})

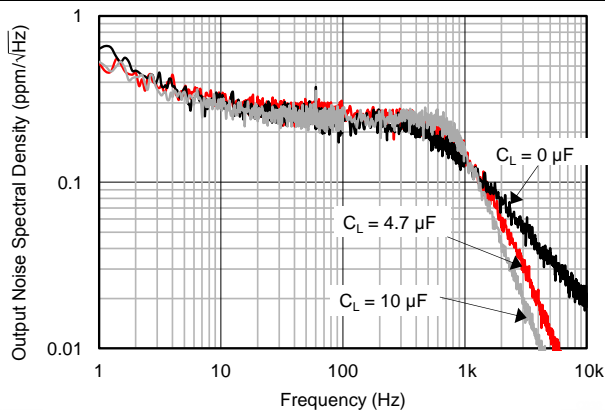

Figure 35. Output Voltage Noise Spectrum

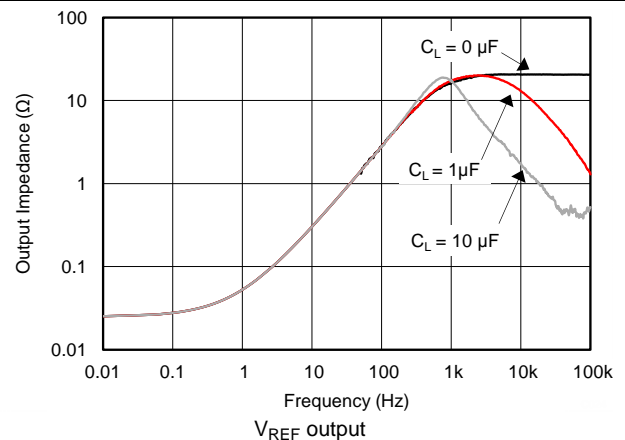

Figure 36. Output Impedance vs Frequency (V_{REF})

Typical Characteristics (continued)

At $T_A = 25^\circ\text{C}$, $I_L = 0\text{ mA}$, $V_{IN} = 5\text{-V}$ power supply, $C_L = 0\ \mu\text{F}$, and 2.5-V output, unless otherwise noted.

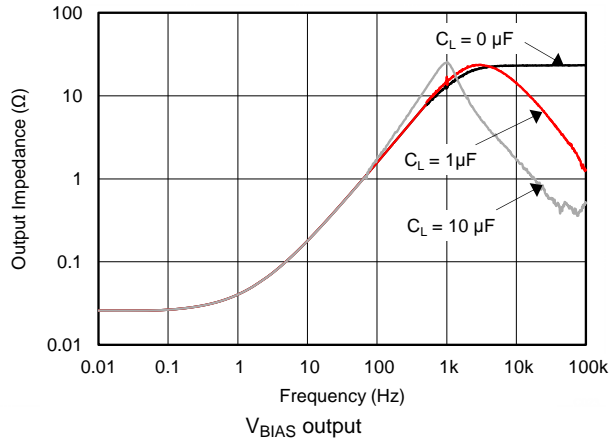

Figure 37. Output Impedance vs Frequency (V_{BIAS})

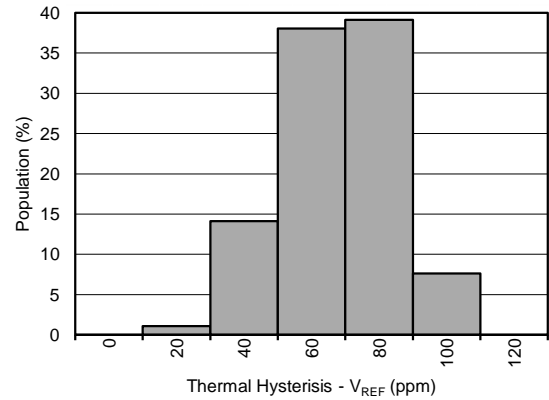

Figure 38. Thermal Hysteresis Distribution (V_{REF})

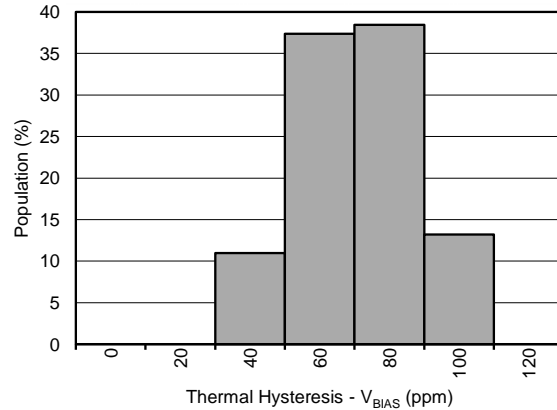

Figure 39. Thermal Hysteresis Distribution (V_{BIAS})

8 Parameter Measurement Information

8.1 Solder Heat Shift

The materials used in the manufacture of the REF20xx have differing coefficients of thermal expansion, resulting in stress on the device die when the part is heated. Mechanical and thermal stress on the device die can cause the output voltages to shift, degrading the initial accuracy specifications of the product. Reflow soldering is a common cause of this error.

In order to illustrate this effect, a total of 92 devices were soldered on four printed circuit boards [23 devices on each printed circuit board (PCB)] using lead-free solder paste and the paste manufacturer suggested reflow profile. The reflow profile is as shown in [Figure 40](#). The printed circuit board is comprised of FR4 material. The board thickness is 1.57 mm and the area is 171.54 mm × 165.1 mm.

The reference and bias output voltages are measured before and after the reflow process; the typical shift is displayed in [Figure 41](#) and [Figure 42](#). Although all tested units exhibit very low shifts (< 0.01%), higher shifts are also possible depending on the size, thickness, and material of the printed circuit board. An important note is that the histograms display the typical shift for exposure to a single reflow profile. Exposure to multiple reflows, as is common on PCBs with surface-mount components on both sides, causes additional shifts in the output bias voltage. If the PCB is exposed to multiple reflows, the device should be soldered in the second pass to minimize its exposure to thermal stress.

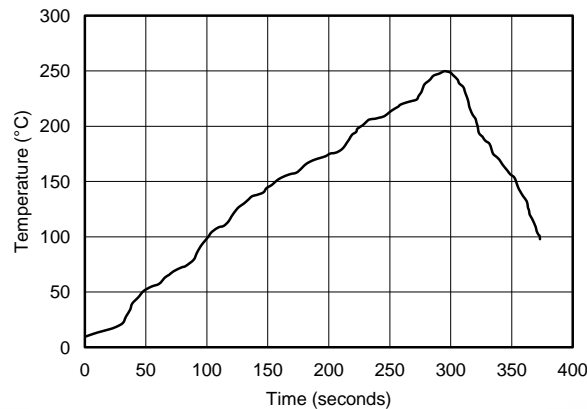

Figure 40. Reflow Profile

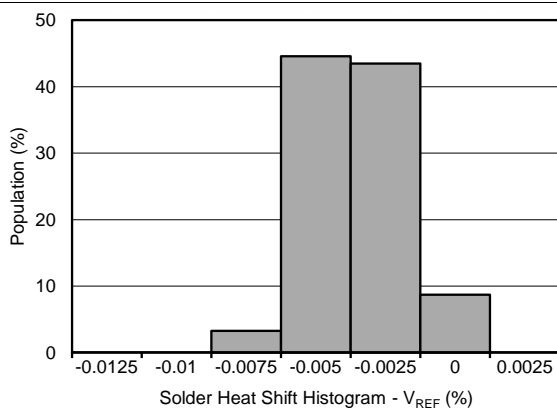

Figure 41. Solder Heat Shift Distribution, V_{REF} (%)

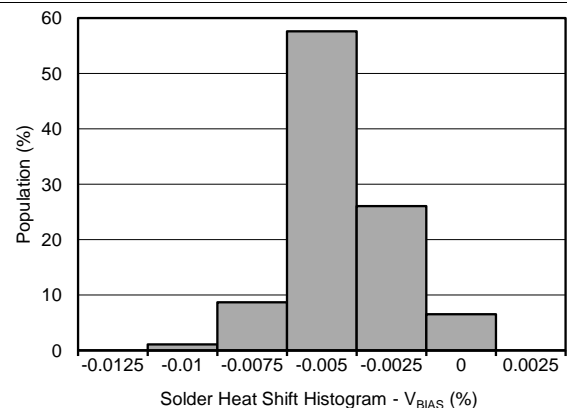

Figure 42. Solder Heat Shift Distribution, V_{BIAS} (%)

8.2 Thermal Hysteresis

Thermal hysteresis is measured with the REF20xx soldered to a PCB, similar to a real-world application. Thermal hysteresis for the device is defined as the change in output voltage after operating the device at 25°C, cycling the device through the specified temperature range, and returning to 25°C. Hysteresis can be expressed by Equation 1:

$$V_{\text{HYST}} = \left(\frac{|V_{\text{PRE}} - V_{\text{POST}}|}{V_{\text{NOM}}} \right) \cdot 10^6 \text{ (ppm)}$$

where

- V_{HYST} = thermal hysteresis (in units of ppm),
- V_{NOM} = the specified output voltage,
- V_{PRE} = output voltage measured at 25°C pre-temperature cycling, and
- V_{POST} = output voltage measured after the device has cycled from 25°C through the specified temperature range of –40°C to 125°C and returns to 25°C. (1)

Typical thermal hysteresis distribution is as shown in Figure 43 and Figure 44.

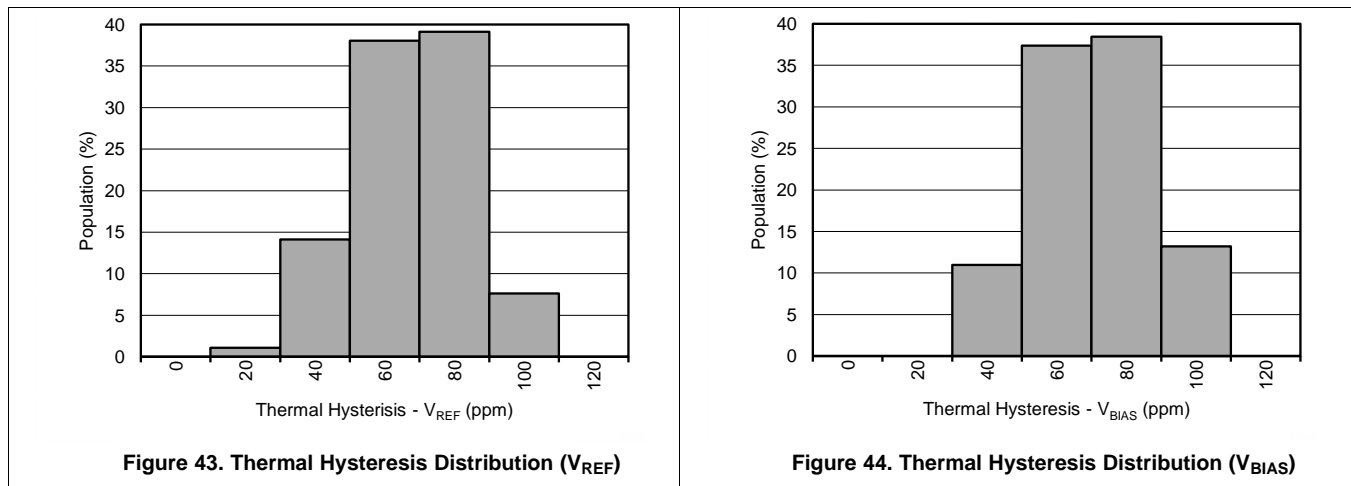

Figure 43. Thermal Hysteresis Distribution (V_{REF})

Figure 44. Thermal Hysteresis Distribution (V_{BIAS})

8.3 Noise Performance

Typical 0.1-Hz to 10-Hz voltage noise can be seen in [Figure 45](#) and [Figure 46](#). Device noise increases with output voltage and operating temperature. Additional filtering can be used to improve output noise levels, although care should be taken to ensure the output impedance does not degrade ac performance. Peak-to-peak noise measurement setup is shown in [Figure 47](#).

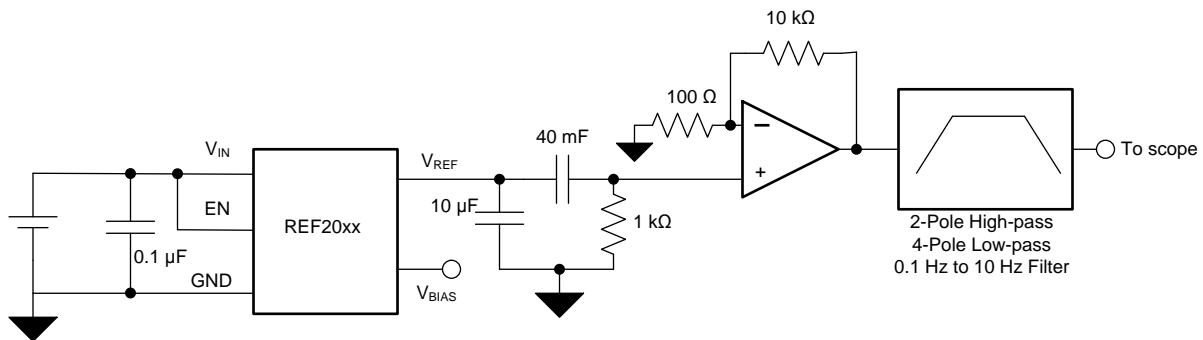
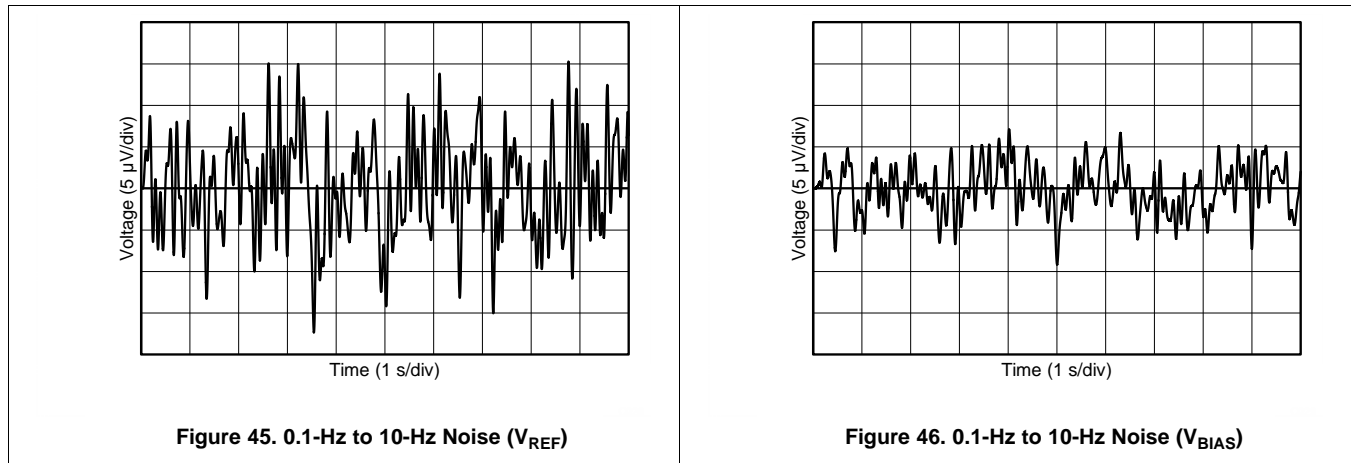

Figure 47. 0.1-Hz to 10-Hz Noise Measurement Setup

9 Detailed Description

9.1 Overview

The REF20xx are a family of dual-output, V_{REF} and V_{BIAS} ($V_{REF} / 2$) band-gap voltage references. The [Functional Block Diagram](#) section provides a block diagram of the basic band-gap topology and the two buffers used to derive the V_{REF} and V_{BIAS} outputs. Transistors Q_1 and Q_2 are biased such that the current density of Q_1 is greater than that of Q_2 . The difference of the two base emitter voltages ($V_{BE1} - V_{BE2}$) has a positive temperature coefficient and is forced across resistor R_5 . The voltage is amplified and added to the base emitter voltage of Q_2 , which has a negative temperature coefficient. The resulting band-gap output voltage is almost independent of temperature. Two independent buffers are used to generate V_{REF} and V_{BIAS} from the band-gap voltage. The resistors R_1 , R_2 and R_3 , R_4 are sized such that $V_{BIAS} = V_{REF} / 2$.

e-Trim™ is a method of package-level trim for the initial accuracy and temperature coefficient of V_{REF} and V_{BIAS} , implemented during the final steps of manufacturing after the plastic molding process. This method minimizes the influence of inherent transistor mismatch, as well as errors induced during package molding. e-Trim is implemented in the REF20xx to minimize the temperature drift and maximize the initial accuracy of both the V_{REF} and V_{BIAS} outputs.

9.2 Functional Block Diagram

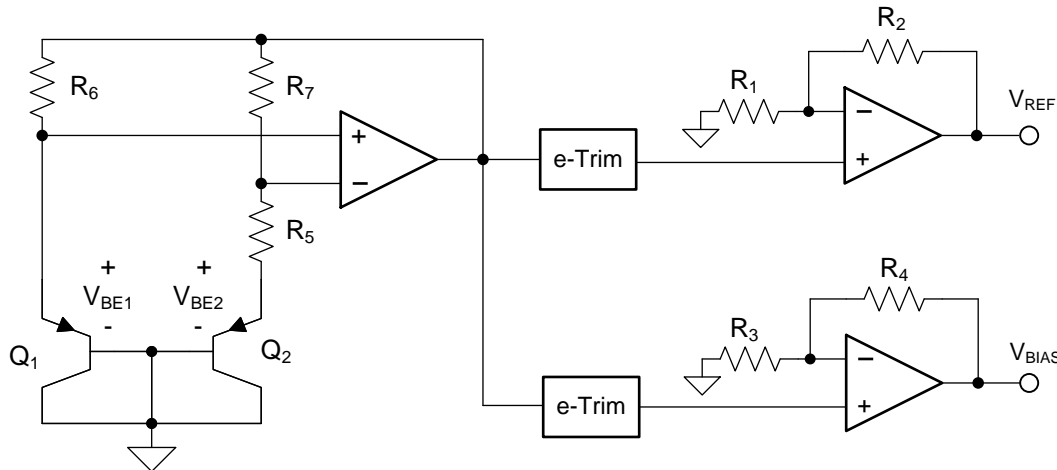

9.3 Feature Description

9.3.1 V_{REF} and V_{BIAS} Tracking

Most single-supply systems require an additional stable voltage in the middle of the analog-to-digital converter (ADC) input range to bias input bipolar signals. The V_{REF} and V_{BIAS} outputs of the REF20xx are generated from the same band-gap voltage as shown in the [Functional Block Diagram](#) section. Hence, both outputs track each other over the full temperature range of -40°C to 125°C with an accuracy of 7 ppm/ $^{\circ}\text{C}$ (max). The tracking accuracy increases to 6 ppm/ $^{\circ}\text{C}$ (max) when the temperature range is limited to -40°C to 85°C . The tracking error is calculated using the box method, as described by [Equation 2](#):

$$\text{Tracking Error} = \left(\frac{V_{\text{DIFF(MAX)}} - V_{\text{DIFF(MIN)}}}{V_{\text{REF}} \cdot \text{Temperature Range}} \right) \cdot 10^6 \quad (\text{ppm})$$

where

$$\bullet \quad V_{\text{DIFF}} = V_{\text{REF}} - 2 \cdot V_{\text{BIAS}} \quad (2)$$

Feature Description (continued)

The tracking accuracy is as shown in Figure 48.

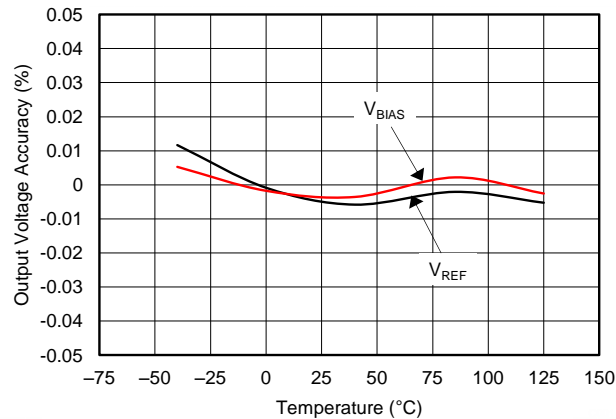

Figure 48. V_{REF} and V_{BIAS} Tracking vs Temperature

9.3.2 Low Temperature Drift

The REF20xx is designed for minimal drift error, which is defined as the change in output voltage over temperature. The drift is calculated using the box method, as described by Equation 3:

$$\text{Drift} = \left(\frac{V_{\text{REF(MAX)}} - V_{\text{REF(MIN)}}}{V_{\text{REF}} \cdot \text{Temperature Range}} \right) \cdot 10^6 \quad (\text{ppm}) \quad (3)$$

9.3.3 Load Current

The REF20xx family is specified to deliver a current load of ± 20 mA per output. Both the V_{REF} and V_{BIAS} outputs of the device are protected from short circuits by limiting the output short-circuit current to 50 mA. The device temperature increases according to Equation 4:

$$T_J = T_A + P_D \cdot R_{\theta JA}$$

where

- T_J = junction temperature (°C),
 - T_A = ambient temperature (°C),
 - P_D = power dissipated (W), and
 - R_{θJA} = junction-to-ambient thermal resistance (°C/W)
- (4)

The REF20xx maximum junction temperature must not exceed the absolute maximum rating of 150°C.

9.4 Device Functional Modes

When the EN pin of the REF20xx is pulled high, the device is in active mode. The device should be in active mode for normal operation. The REF20xx can be placed in a low-power mode by pulling the ENABLE pin low. When in shutdown mode, the output of the device becomes high impedance and the quiescent current of the device reduces to 5 μA in shutdown mode. See the [Electrical Characteristics](#) for logic high and logic low voltage levels.

10 Applications and Implementation

10.1 Application Information

The low-drift, bidirectional, single-supply, low-side, current-sensing solution, described in this section, can accurately detect load currents from -2.5 A to 2.5 A. The linear range of the output is from 250 mV to 2.75 V. Positive current is represented by output voltages from 1.5 V to 2.75 V, whereas negative current is represented by output voltages from 250 mV to 1.5 V. The difference amplifier is the [INA213](#) current-shunt monitor, whose supply and reference voltages are supplied by the low-drift REF2030.

10.2 Typical Application

10.2.1 Low-Side, Current-Sensing Application

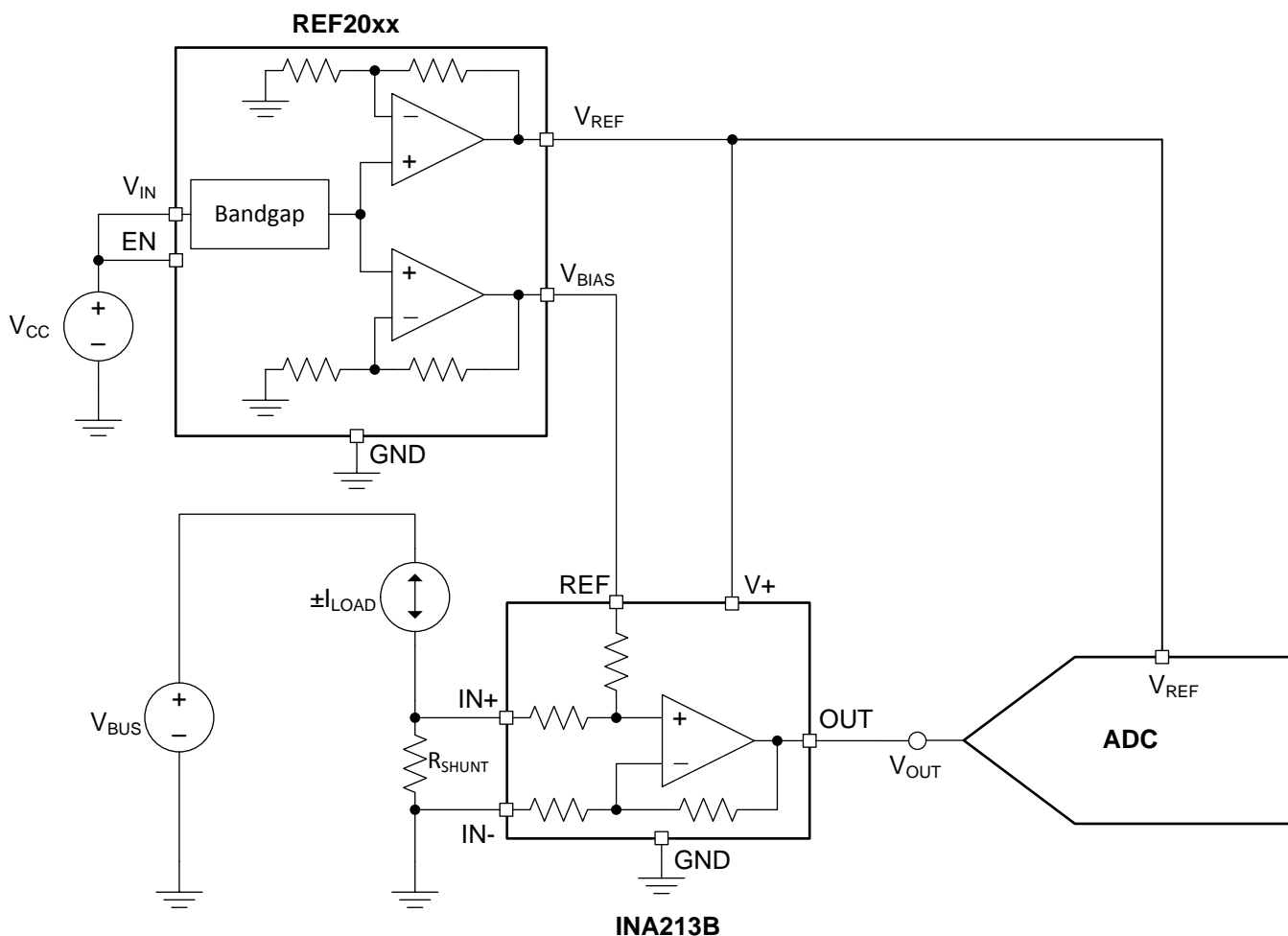

Figure 49. Low-Side, Current-Sensing Application

10.2.1.1 Design Requirements

The design requirements are as follows:

1. Supply voltage: 5.0 V
2. Load current: ± 2.5 A
3. Output: 250 mV to 2.75 V
4. Maximum shunt voltage: ± 25 mV

Typical Application (continued)

10.2.1.2 Detailed Design Procedure

Low-side current sensing is desirable because the common-mode voltage is near ground. Therefore, the current-sensing solution is independent of the bus voltage, V_{BUS} . When sensing bidirectional currents, use a differential amplifier with a reference pin. This procedure allows for the differentiation between positive and negative currents by biasing the output stage such that it can respond to negative input voltages. There are a variety of methods for supplying power ($V+$) and the reference voltage (V_{REF} , or V_{BIAS}) to the differential amplifier. For a low-drift solution, use a monolithic reference that supplies both power and the reference voltage. Figure 50 shows the general circuit topology for a low-drift, low-side, bidirectional, current-sensing solution. This topology is particularly useful when interfacing with an ADC; see Figure 49. Not only do V_{REF} and V_{BIAS} track over temperature, but their matching is much better than alternate topologies. For a more detailed version of the design procedure, refer to TIDU357.

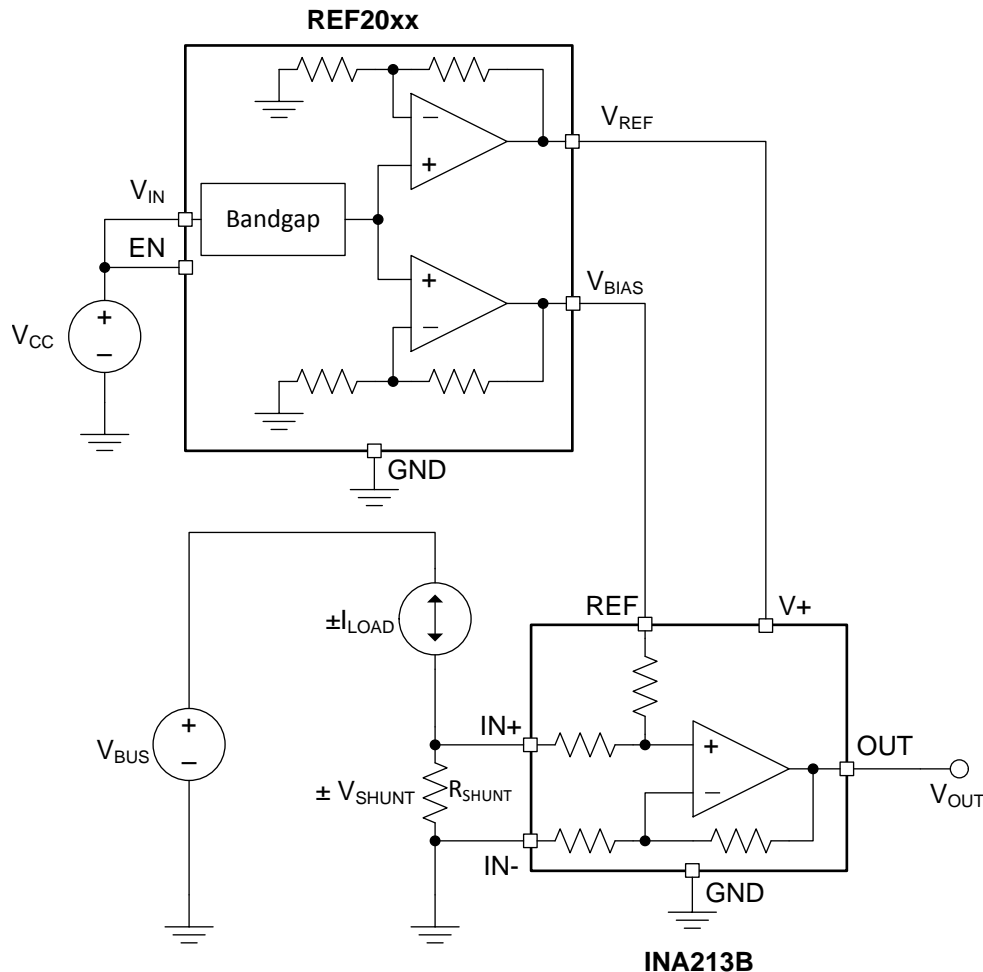

Figure 50. Low-Drift, Low-side, Bidirectional, Current-Sensing Circuit Topology

The transfer function for the circuit given in Figure 50 is as shown in Equation 5:

$$\begin{aligned}
 V_{OUT} &= G \cdot (\pm V_{SHUNT}) + V_{BIAS} \\
 &= G \cdot (\pm I_{LOAD} \cdot R_{SHUNT}) + V_{BIAS}
 \end{aligned}
 \tag{5}$$

Typical Application (continued)

10.2.1.2.1 Shunt Resistor

As illustrated in [Figure 50](#), the value of V_{SHUNT} is the ground potential for the system load. If the value of V_{SHUNT} is too large, issues may arise when interfacing with systems whose ground potential is actually 0 V. Also, a value of V_{SHUNT} that is too negative may violate the input common-mode voltage of the differential amplifier in addition to potential interfacing issues. Therefore, limiting the voltage across the shunt resistor is important. [Equation 6](#) can be used to calculate the maximum value of R_{SHUNT} .

$$R_{SHUNT(max)} = \frac{V_{SHUNT(max)}}{I_{LOAD(max)}} \quad (6)$$

Given that the maximum shunt voltage is ± 25 mV and the load current range is ± 2.5 A, the maximum shunt resistance is calculated as shown in [Equation 7](#).

$$R_{SHUNT(max)} = \frac{V_{SHUNT(max)}}{I_{LOAD(max)}} = \frac{25mV}{2.5A} = 10m\Omega \quad (7)$$

To minimize errors over temperature, select a low-drift shunt resistor. To minimize offset error, select a shunt resistor with the lowest tolerance. For this design, the Y14870R01000B9W resistor is used.

10.2.1.2.2 Differential Amplifier

The differential amplifier used for this design should have the following features:

1. Single-supply (3 V),
2. Reference voltage input,
3. Low initial input offset voltage (V_{OS}),
4. Low-drift,
5. Fixed gain, and
6. Low-side sensing (input common-mode range below ground).

For this design, a current-shunt monitor (INA213) is used. The INA21x family topology is shown in [Figure 51](#). The INA213B specifications can be found in the [INA213 product data sheet](#).

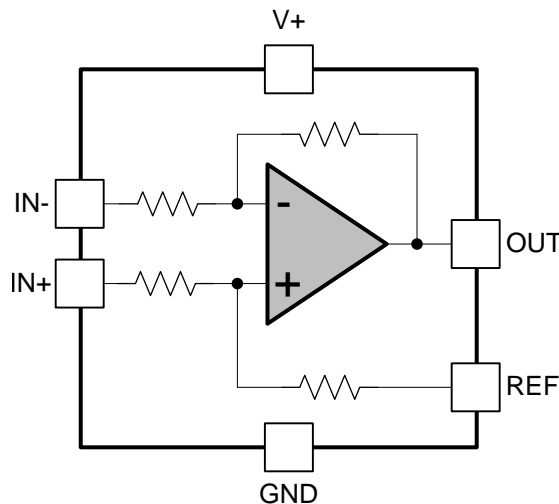

Figure 51. INA21x Current-Shunt Monitor Topology

The INA213B is an excellent choice for this application because all the required features are included. In general, instrumentation amplifiers (INAs) do not have the input common-mode swing to ground that is essential for this application. In addition, INAs require external resistors to set their gain, which is not desirable for low-drift applications. Difference amplifiers typically have larger input bias currents, which reduce solution accuracy at small load currents. Difference amplifiers typically have a gain of 1 V/V. When the gain is adjustable, these amplifiers use external resistors that are not conducive to low-drift applications.

Typical Application (continued)

10.2.1.2.3 Voltage Reference

The voltage reference for this application should have the following features:

1. Dual output (3.0 V and 1.5 V),
2. Low drift, and
3. Low tracking errors between the two outputs.

For this design, the REF2030 is used. The REF20xx topology is as shown in the [Functional Block Diagram](#) section.

The REF2030 is an excellent choice for this application because of its dual output. The temperature drift of 8 ppm/°C and initial accuracy of 0.05% make the errors resulting from the voltage reference minimal in this application. In addition, there is minimal mismatch between the two outputs and both outputs track very well across temperature, as shown in [Figure 52](#) and [Figure 53](#).

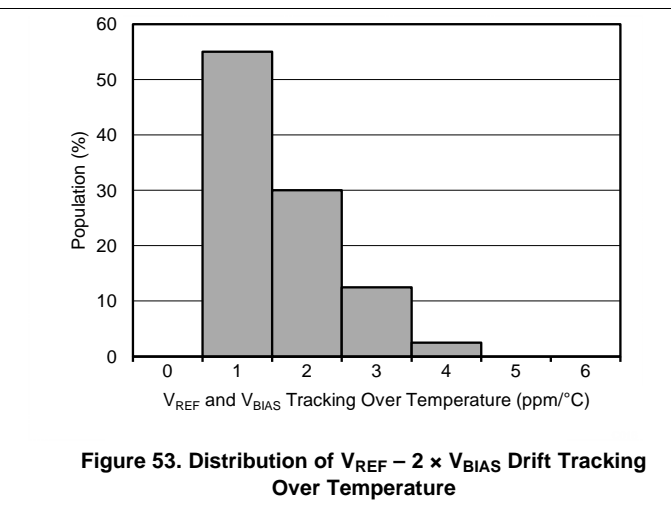
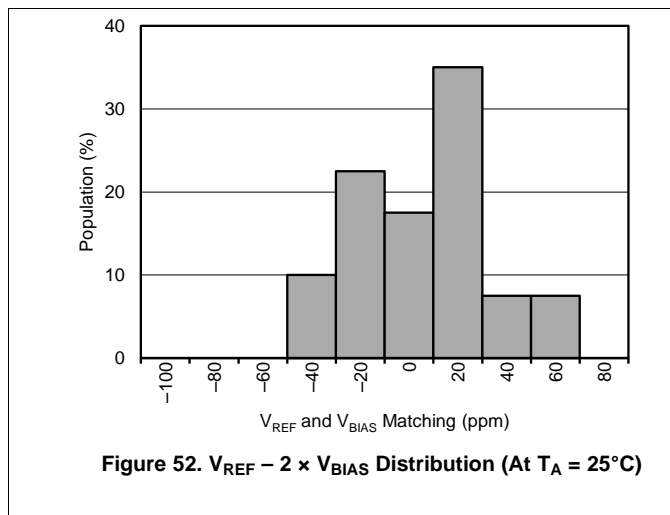

10.2.1.2.4 Results

[Table 1](#) summarizes the measured results.

Table 1. Measured Results

ERROR	UNCALIBRATED (%)	CALIBRATED (%)
Error across the full load current range (25°C)	±0.0355	±0.004
Error across the full load current range (-40°C to 125°C)	±0.0522	±0.0606

10.2.1.3 Application Curves

Performing a two-point calibration at 25°C removes the errors associated with offset voltage, gain error, and so forth. [Figure 54](#) to [Figure 56](#) show the measured error at different conditions. For a more detailed description on measurement procedure, calibration, and calculations, please refer to [TIDU357](#).

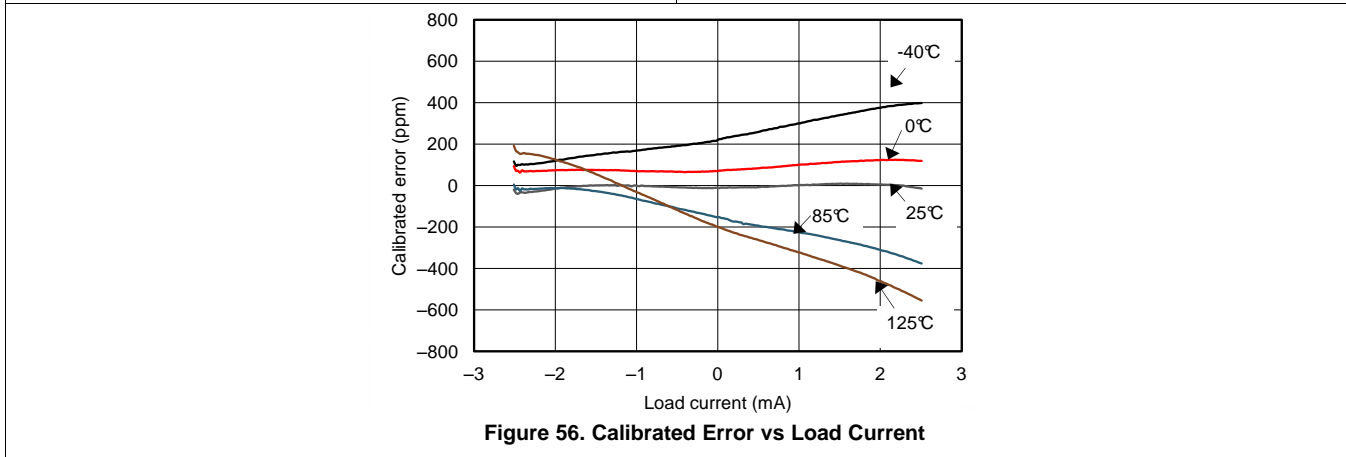
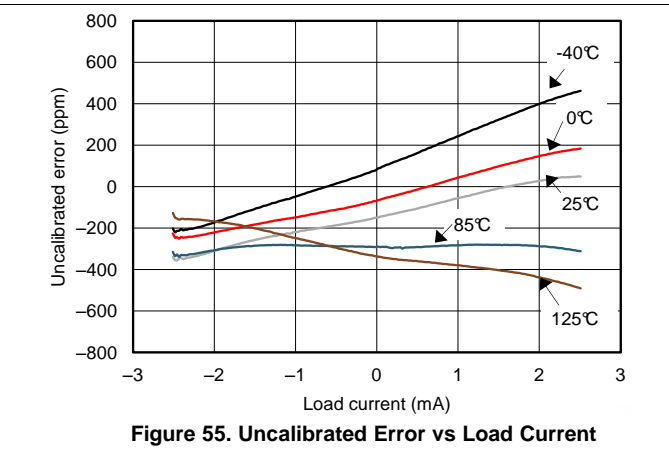
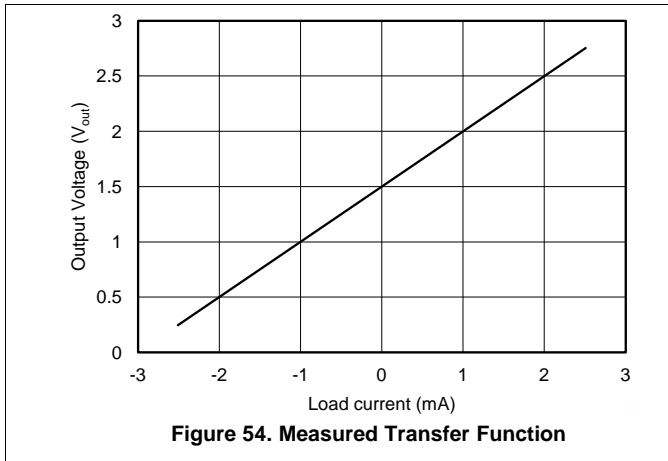

11 Power-Supply Recommendations

The REF20xx family of references feature an extremely low-dropout voltage. These references can be operated with a supply of only 20 mV above the output voltage. For loaded reference conditions, a typical dropout voltage versus load is shown in the [Figure 57](#). A supply bypass capacitor ranging between 0.1 μF to 10 μF is recommended.

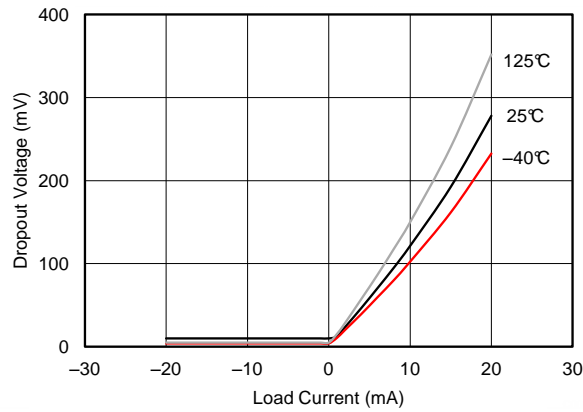

Figure 57. Dropout Voltage vs Load Current

12 Layout

12.1 Layout Guidelines

Figure 58 illustrates an example of a PCB layout for a data acquisition system using the REF2030. Some key considerations are:

- Connect low-ESR, 0.1- μ F ceramic bypass capacitors at V_{IN} , V_{REF} , and V_{BIAS} of the REF2030.
- Decouple other active devices in the system per the device specifications.
- Using a solid ground plane helps distribute heat and reduces electromagnetic interference (EMI) noise pickup.
- Place the external components as close to the device as possible. This configuration prevents parasitic errors (such as the Seebeck effect) from occurring.
- Minimize trace length between the reference and bias connections to the INA and ADC to reduce noise pickup.
- Do not run sensitive analog traces in parallel with digital traces. Avoid crossing digital and analog traces if possible, and only make perpendicular crossings when absolutely necessary.

12.2 Layout Example

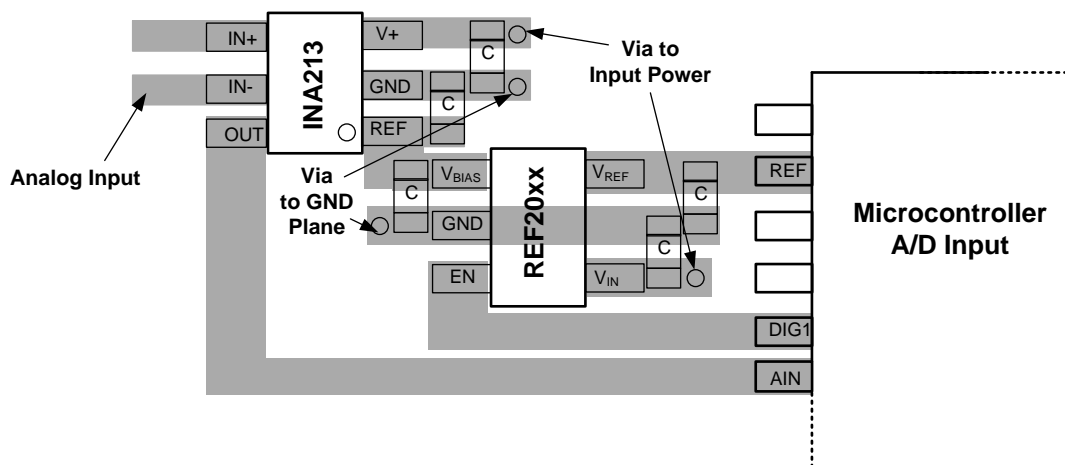

Figure 58. Layout Example

13 Device and Documentation Support

13.1 Documentation Support

13.1.1 Related Documentation

For related documentation see the following:

- INA213 Data Sheet, [SBOS437](#)
- *Low-Drift Bidirectional Single-Supply Low-Side Current Sensing Reference Design*, [TIDU357](#)

13.2 Related Links

The table below lists quick access links. Categories include technical documents, support and community resources, tools and software, and quick access to sample or buy.

Table 2. Related Links

PARTS	PRODUCT FOLDER	SAMPLE & BUY	TECHNICAL DOCUMENTS	TOOLS & SOFTWARE	SUPPORT & COMMUNITY
REF2025	Click here	Click here	Click here	Click here	Click here
REF2030	Click here	Click here	Click here	Click here	Click here
REF2033	Click here	Click here	Click here	Click here	Click here
REF2041	Click here	Click here	Click here	Click here	Click here

13.3 Trademarks

e-Trim is a trademark of Texas Instruments, Inc.
All other trademarks are the property of their respective owners.

13.4 Electrostatic Discharge Caution



These devices have limited built-in ESD protection. The leads should be shorted together or the device placed in conductive foam during storage or handling to prevent electrostatic damage to the MOS gates.

13.5 Glossary

[SLYZ022](#) — *TI Glossary*.

This glossary lists and explains terms, acronyms, and definitions.

14 Mechanical, Packaging, and Orderable Information

The following pages include mechanical packaging and orderable information. This information is the most current data available for the designated devices. This data is subject to change without notice and revision of this document. For browser-based versions of this data sheet, refer to the left-hand navigation.

PACKAGING INFORMATION

Orderable Device	Status (1)	Package Type	Package Drawing	Pins	Package Qty	Eco Plan (2)	Lead/Ball Finish (6)	MSL Peak Temp (3)	Op Temp (°C)	Device Marking (4/5)	Samples
REF2025AIDDCR	ACTIVE	SOT	DDC	5	3000	Green (RoHS & no Sb/Br)	CU NIPDAU	Level-2-260C-1 YEAR	-40 to 125	GACM	Samples
REF2025AIDDCT	ACTIVE	SOT	DDC	5	250	Green (RoHS & no Sb/Br)	CU NIPDAU	Level-2-260C-1 YEAR	-40 to 125	GACM	Samples
REF2030AIDDCR	ACTIVE	SOT	DDC	5	3000	Green (RoHS & no Sb/Br)	CU NIPDAU	Level-2-260C-1 YEAR	-40 to 125	GADM	Samples
REF2030AIDDCT	ACTIVE	SOT	DDC	5	250	Green (RoHS & no Sb/Br)	CU NIPDAU	Level-2-260C-1 YEAR	-40 to 125	GADM	Samples
REF2033AIDDCR	ACTIVE	SOT	DDC	5	3000	Green (RoHS & no Sb/Br)	CU NIPDAU	Level-2-260C-1 YEAR	-40 to 125	GAEM	Samples
REF2033AIDDCT	ACTIVE	SOT	DDC	5	250	Green (RoHS & no Sb/Br)	CU NIPDAU	Level-2-260C-1 YEAR	-40 to 125	GAEM	Samples
REF2041AIDDCR	ACTIVE	SOT	DDC	5	3000	Green (RoHS & no Sb/Br)	CU NIPDAU	Level-2-260C-1 YEAR	-40 to 125	GAFM	Samples
REF2041AIDDCT	ACTIVE	SOT	DDC	5	250	Green (RoHS & no Sb/Br)	CU NIPDAU	Level-2-260C-1 YEAR	-40 to 125	GAFM	Samples

(1) The marketing status values are defined as follows:

ACTIVE: Product device recommended for new designs.

LIFEBUY: TI has announced that the device will be discontinued, and a lifetime-buy period is in effect.

NRND: Not recommended for new designs. Device is in production to support existing customers, but TI does not recommend using this part in a new design.

PREVIEW: Device has been announced but is not in production. Samples may or may not be available.

OBSOLETE: TI has discontinued the production of the device.

(2) Eco Plan - The planned eco-friendly classification: Pb-Free (RoHS), Pb-Free (RoHS Exempt), or Green (RoHS & no Sb/Br) - please check <http://www.ti.com/productcontent> for the latest availability information and additional product content details.

TBD: The Pb-Free/Green conversion plan has not been defined.

Pb-Free (RoHS): TI's terms "Lead-Free" or "Pb-Free" mean semiconductor products that are compatible with the current RoHS requirements for all 6 substances, including the requirement that lead not exceed 0.1% by weight in homogeneous materials. Where designed to be soldered at high temperatures, TI Pb-Free products are suitable for use in specified lead-free processes.

Pb-Free (RoHS Exempt): This component has a RoHS exemption for either 1) lead-based flip-chip solder bumps used between the die and package, or 2) lead-based die adhesive used between the die and leadframe. The component is otherwise considered Pb-Free (RoHS compatible) as defined above.

Green (RoHS & no Sb/Br): TI defines "Green" to mean Pb-Free (RoHS compatible), and free of Bromine (Br) and Antimony (Sb) based flame retardants (Br or Sb do not exceed 0.1% by weight in homogeneous material)

(3) MSL, Peak Temp. - The Moisture Sensitivity Level rating according to the JEDEC industry standard classifications, and peak solder temperature.

(4) There may be additional marking, which relates to the logo, the lot trace code information, or the environmental category on the device.

(5) Multiple Device Markings will be inside parentheses. Only one Device Marking contained in parentheses and separated by a "~" will appear on a device. If a line is indented then it is a continuation of the previous line and the two combined represent the entire Device Marking for that device.

(6) Lead/Ball Finish - Orderable Devices may have multiple material finish options. Finish options are separated by a vertical ruled line. Lead/Ball Finish values may wrap to two lines if the finish value exceeds the maximum column width.

Important Information and Disclaimer:The information provided on this page represents TI's knowledge and belief as of the date that it is provided. TI bases its knowledge and belief on information provided by third parties, and makes no representation or warranty as to the accuracy of such information. Efforts are underway to better integrate information from third parties. TI has taken and continues to take reasonable steps to provide representative and accurate information but may not have conducted destructive testing or chemical analysis on incoming materials and chemicals. TI and TI suppliers consider certain information to be proprietary, and thus CAS numbers and other limited information may not be available for release.

In no event shall TI's liability arising out of such information exceed the total purchase price of the TI part(s) at issue in this document sold by TI to Customer on an annual basis.

TAPE AND REEL INFORMATION



QUADRANT ASSIGNMENTS FOR PIN 1 ORIENTATION IN TAPE



*All dimensions are nominal

Device	Package Type	Package Drawing	Pins	SPQ	Reel Diameter (mm)	Reel Width W1 (mm)	A0 (mm)	B0 (mm)	K0 (mm)	P1 (mm)	W (mm)	Pin1 Quadrant
REF2025AIDDCR	SOT	DDC	5	3000	179.0	8.4	3.2	3.2	1.4	4.0	8.0	Q3
REF2025AIDDCT	SOT	DDC	5	250	179.0	8.4	3.2	3.2	1.4	4.0	8.0	Q3
REF2030AIDDCR	SOT	DDC	5	3000	179.0	8.4	3.2	3.2	1.4	4.0	8.0	Q3
REF2030AIDDCT	SOT	DDC	5	250	179.0	8.4	3.2	3.2	1.4	4.0	8.0	Q3
REF2033AIDDCR	SOT	DDC	5	3000	179.0	8.4	3.2	3.2	1.4	4.0	8.0	Q3
REF2033AIDDCT	SOT	DDC	5	250	179.0	8.4	3.2	3.2	1.4	4.0	8.0	Q3
REF2041AIDDCR	SOT	DDC	5	3000	179.0	8.4	3.2	3.2	1.4	4.0	8.0	Q3
REF2041AIDDCT	SOT	DDC	5	250	179.0	8.4	3.2	3.2	1.4	4.0	8.0	Q3

TAPE AND REEL BOX DIMENSIONS

*All dimensions are nominal

Device	Package Type	Package Drawing	Pins	SPQ	Length (mm)	Width (mm)	Height (mm)
REF2025AIDDCR	SOT	DDC	5	3000	195.0	200.0	45.0
REF2025AIDDCT	SOT	DDC	5	250	195.0	200.0	45.0
REF2030AIDDCR	SOT	DDC	5	3000	195.0	200.0	45.0
REF2030AIDDCT	SOT	DDC	5	250	195.0	200.0	45.0
REF2033AIDDCR	SOT	DDC	5	3000	195.0	200.0	45.0
REF2033AIDDCT	SOT	DDC	5	250	195.0	200.0	45.0
REF2041AIDDCR	SOT	DDC	5	3000	195.0	200.0	45.0
REF2041AIDDCT	SOT	DDC	5	250	195.0	200.0	45.0

DDC (R-PDSO-G5)

PLASTIC SMALL-OUTLINE

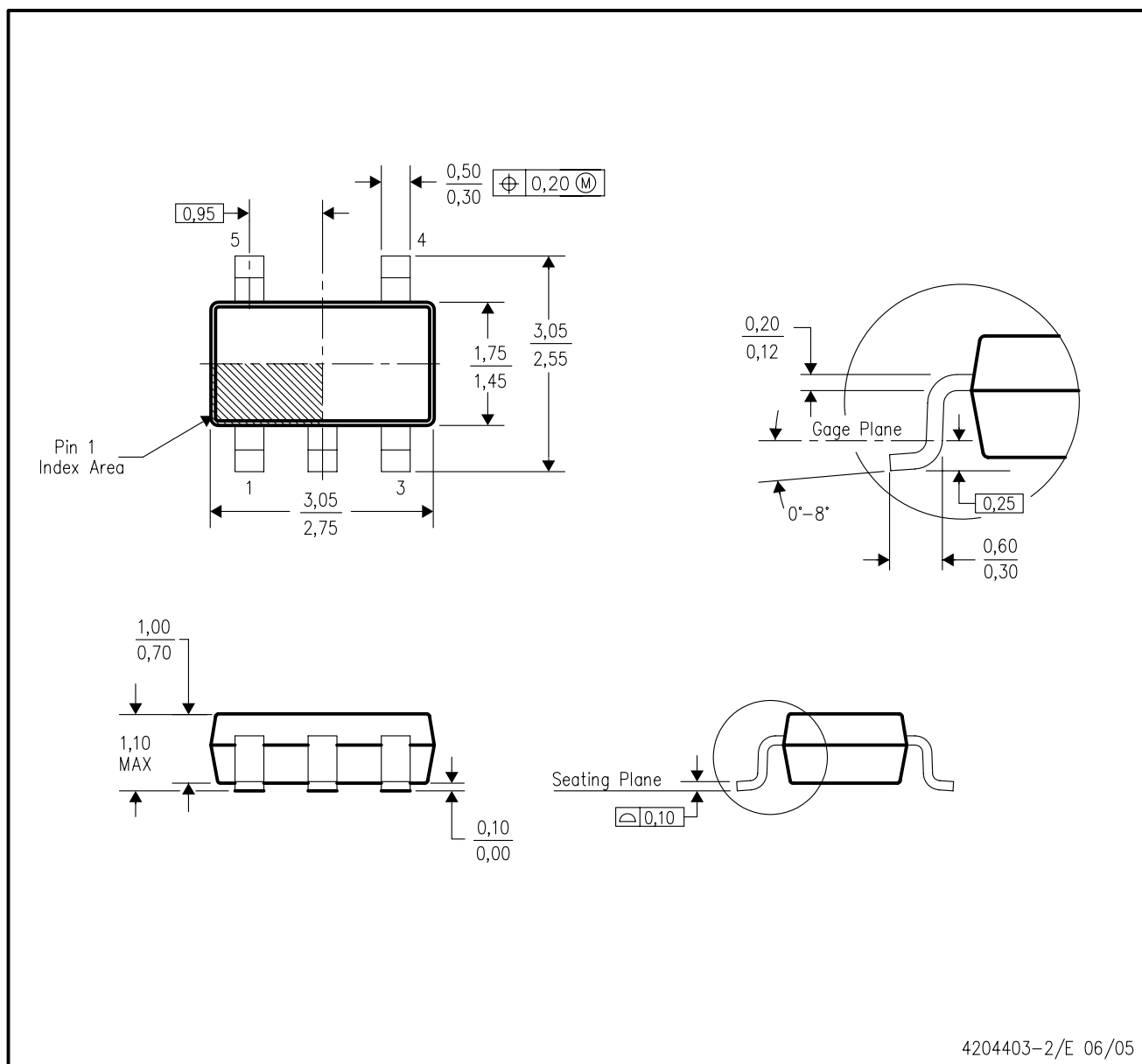

- NOTES:
- All linear dimensions are in millimeters.
 - This drawing is subject to change without notice.
 - Body dimensions do not include mold flash or protrusion.
 - Falls within JEDEC MO-193 variation AB (5 pin).

DDC (R-PDSO-G5)

PLASTIC SMALL OUTLINE

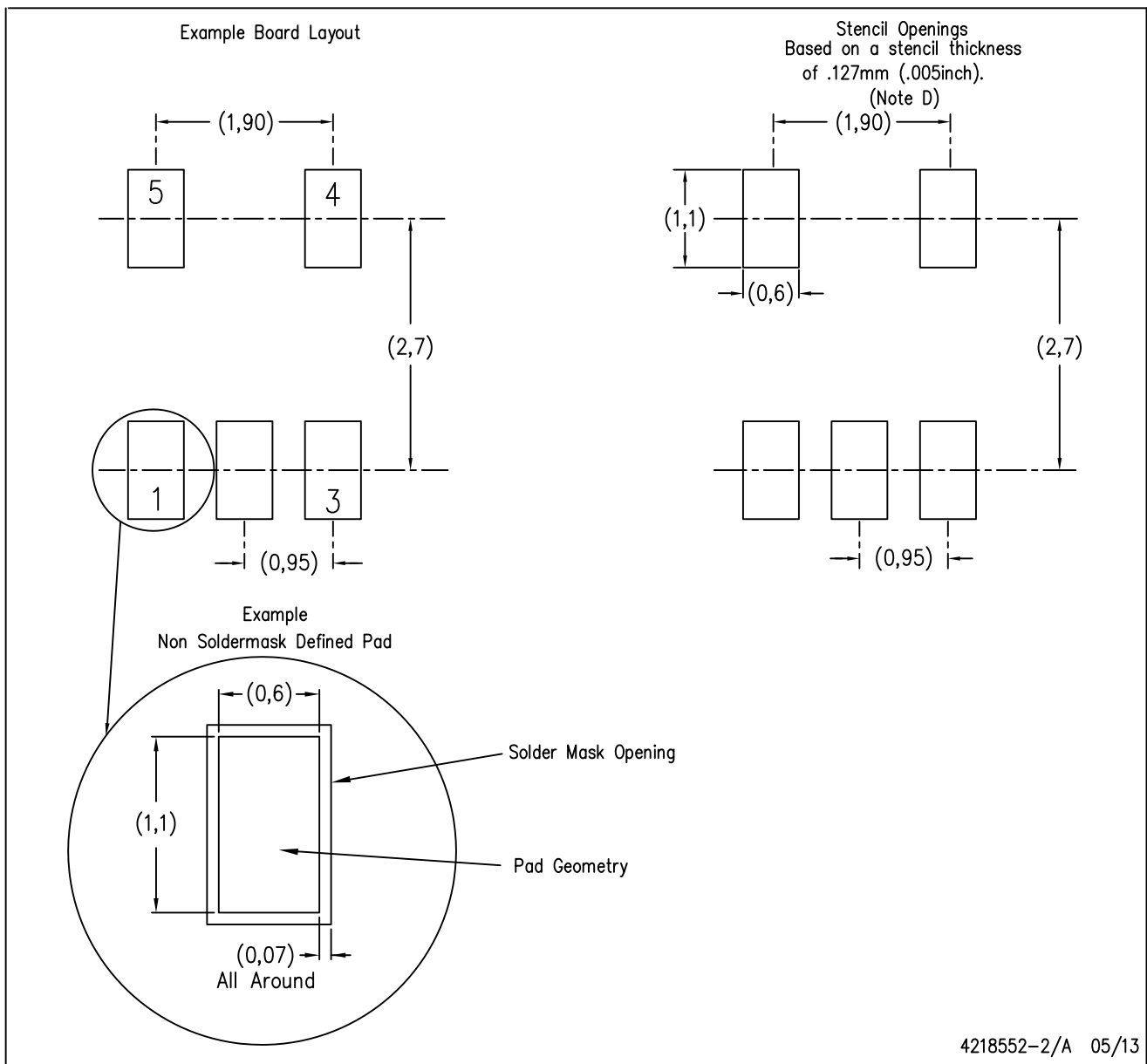

- NOTES:
- A. All linear dimensions are in millimeters.
 - B. This drawing is subject to change without notice.
 - C. Publication IPC-7351 is recommended for alternate designs.
 - D. Laser cutting apertures with trapezoidal walls and also rounding corners will offer better paste release. Customers should contact their board assembly site for stencil design recommendations. Example stencil design based on a 50% volumetric metal load solder paste. Refer to IPC-7525 for other stencil recommendations.

IMPORTANT NOTICE

Texas Instruments Incorporated and its subsidiaries (TI) reserve the right to make corrections, enhancements, improvements and other changes to its semiconductor products and services per JESD46, latest issue, and to discontinue any product or service per JESD48, latest issue. Buyers should obtain the latest relevant information before placing orders and should verify that such information is current and complete. All semiconductor products (also referred to herein as "components") are sold subject to TI's terms and conditions of sale supplied at the time of order acknowledgment.

TI warrants performance of its components to the specifications applicable at the time of sale, in accordance with the warranty in TI's terms and conditions of sale of semiconductor products. Testing and other quality control techniques are used to the extent TI deems necessary to support this warranty. Except where mandated by applicable law, testing of all parameters of each component is not necessarily performed.

TI assumes no liability for applications assistance or the design of Buyers' products. Buyers are responsible for their products and applications using TI components. To minimize the risks associated with Buyers' products and applications, Buyers should provide adequate design and operating safeguards.

TI does not warrant or represent that any license, either express or implied, is granted under any patent right, copyright, mask work right, or other intellectual property right relating to any combination, machine, or process in which TI components or services are used. Information published by TI regarding third-party products or services does not constitute a license to use such products or services or a warranty or endorsement thereof. Use of such information may require a license from a third party under the patents or other intellectual property of the third party, or a license from TI under the patents or other intellectual property of TI.

Reproduction of significant portions of TI information in TI data books or data sheets is permissible only if reproduction is without alteration and is accompanied by all associated warranties, conditions, limitations, and notices. TI is not responsible or liable for such altered documentation. Information of third parties may be subject to additional restrictions.

Resale of TI components or services with statements different from or beyond the parameters stated by TI for that component or service voids all express and any implied warranties for the associated TI component or service and is an unfair and deceptive business practice. TI is not responsible or liable for any such statements.

Buyer acknowledges and agrees that it is solely responsible for compliance with all legal, regulatory and safety-related requirements concerning its products, and any use of TI components in its applications, notwithstanding any applications-related information or support that may be provided by TI. Buyer represents and agrees that it has all the necessary expertise to create and implement safeguards which anticipate dangerous consequences of failures, monitor failures and their consequences, lessen the likelihood of failures that might cause harm and take appropriate remedial actions. Buyer will fully indemnify TI and its representatives against any damages arising out of the use of any TI components in safety-critical applications.

In some cases, TI components may be promoted specifically to facilitate safety-related applications. With such components, TI's goal is to help enable customers to design and create their own end-product solutions that meet applicable functional safety standards and requirements. Nonetheless, such components are subject to these terms.

No TI components are authorized for use in FDA Class III (or similar life-critical medical equipment) unless authorized officers of the parties have executed a special agreement specifically governing such use.

Only those TI components which TI has specifically designated as military grade or "enhanced plastic" are designed and intended for use in military/aerospace applications or environments. Buyer acknowledges and agrees that any military or aerospace use of TI components which have **not** been so designated is solely at the Buyer's risk, and that Buyer is solely responsible for compliance with all legal and regulatory requirements in connection with such use.

TI has specifically designated certain components as meeting ISO/TS16949 requirements, mainly for automotive use. In any case of use of non-designated products, TI will not be responsible for any failure to meet ISO/TS16949.

Products

Audio	www.ti.com/audio
Amplifiers	amplifier.ti.com
Data Converters	dataconverter.ti.com
DLP® Products	www.dlp.com
DSP	dsp.ti.com
Clocks and Timers	www.ti.com/clocks
Interface	interface.ti.com
Logic	logic.ti.com
Power Mgmt	power.ti.com
Microcontrollers	microcontroller.ti.com
RFID	www.ti-rfid.com
OMAP Applications Processors	www.ti.com/omap
Wireless Connectivity	www.ti.com/wirelessconnectivity

Applications

Automotive and Transportation	www.ti.com/automotive
Communications and Telecom	www.ti.com/communications
Computers and Peripherals	www.ti.com/computers
Consumer Electronics	www.ti.com/consumer-apps
Energy and Lighting	www.ti.com/energy
Industrial	www.ti.com/industrial
Medical	www.ti.com/medical
Security	www.ti.com/security
Space, Avionics and Defense	www.ti.com/space-avionics-defense
Video and Imaging	www.ti.com/video

TI E2E Community

e2e.ti.com