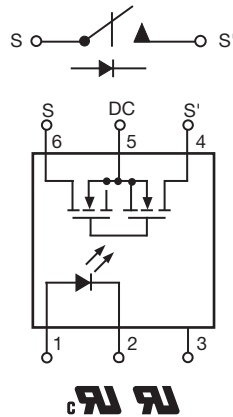


## 1 Form A Solid State Relay



20091



### FEATURES

- High speed SSR -  $t_{on}/t_{off} < 800 \mu s$
- Maximum  $R_{ON} 0.25 \Omega$
- Isolation test voltage 5300 V<sub>RMS</sub>
- Load voltage 60 V
- Load current 2 A DC configuration
- DIP-6 package
- Clean bounce free switching
- TTL/CMOS compatible input
- Available on tape and reel
- Pure tin leads
- Compliant to RoHS Directive 2002/95/EC and in accordance to WEEE 2002/96/EC



**RoHS**  
COMPLIANT

### DESCRIPTION

The VO14642AT are high speed SPST normally open (1 form A) solid-state relay in a DIP-6 package. The relays are constructed as a multi-chip hybrid device. Actuation control is via an infrared LED. The output switch is a combination of a photodiode array with MOSFET switches. The relays can be configured for AC/DC or DC only operation.

### APPLICATIONS

- Instrumentation
- Industrial controls
- Security

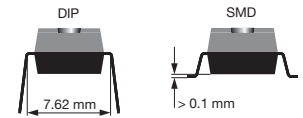
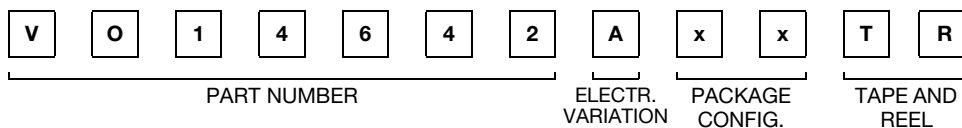
### AGENCY APPROVALS

UL1577: file no. E52744 system code H, double protection  
 cUL - UL1577: file no. E52744 system code H, double protection

### Notes

- IEC 60747-5-2 (VDE 0884) capable, consult sales representative for details
- Agency approvals are valid only for ambient temperature range - 40 °C to 85 °C

### ORDERING INFORMATION



PACKAGE	UL, cUL
SMD-6, tape and reel	VO14642AABTR
DIP-6, Tubes	VO14642AT

<b>ABSOLUTE MAXIMUM RATINGS (1)</b> ( $T_{amb} = 25\text{ }^{\circ}\text{C}$ , unless otherwise specified)				
PARAMETER	TEST CONDITION	SYMBOL	VALUE	UNIT
<b>INPUT</b>				
LED continuous forward current		$I_F$	50	mA
LED reverse voltage		$V_R$	5	V
LED power dissipation	at 25 °C	$P_{diss}$	80	mW
<b>OUTPUT</b>				
DC or peak AC load voltage		$V_L$	60	V
Load current (DC only)		$I_L$	2	A
Peak load current (AC/DC)	$t = 10\text{ ms}$	$I_{LPK}$	3.6	A
Output power dissipation	at 25 °C	$P_{diss}$	250	mW
<b>SSR</b>				
Total power dissipation		$P_{diss}$	330	mW
Ambient temperature range		$T_{amb}$	- 55 to + 85	°C
Storage temperature range		$T_{stg}$	- 55 to + 125	°C
Soldering temperature (2)	$t \leq 10\text{ s max.}$	$T_{sld}$	260	°C
Isolation test voltage	for 1 s	$V_{ISO}$	5300	$V_{RMS}$

**Notes**

(1) Stresses in excess of the absolute maximum ratings can cause permanent damage to the device. Functional operation of the device is not implied at these or any other conditions in excess of those given in the operational sections of this document. Exposure to absolute maximum ratings for extended periods of the time can adversely affect reliability.

(2) Refer to reflow profile for soldering conditions for surface mounted devices (SMD). Refer to wave profile for soldering conditions for through hole devices (DIP).

**ABSOLUTE MAXIMUM RATING CURVE**

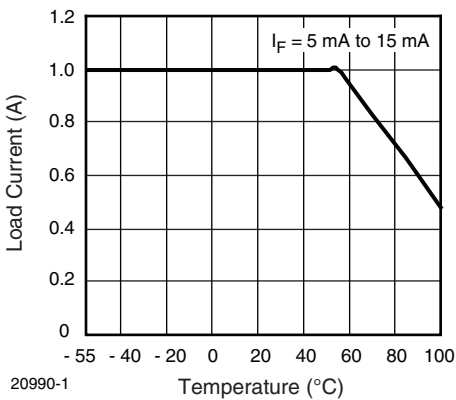
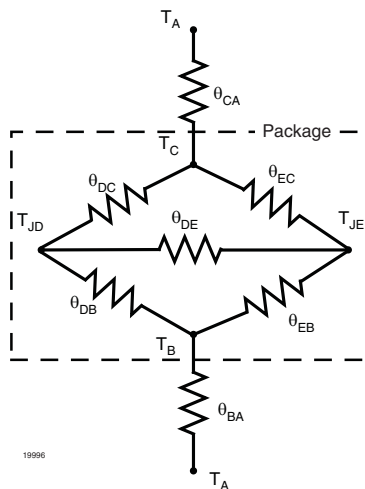


Fig. 1 - Load Current (AC/DC) vs. Temperature

<b>THERMAL CHARACTERISTICS</b>				
PARAMETER	TEST CONDITION	SYMBOL	VALUE	UNIT
Maximum LED junction temperature	at 25 °C	$T_{jmax.}$	125	°C
Maximum output die junction temperature	at 25 °C	$T_{jmax.}$	125	°C
Thermal resistance, junction emitter to board	at 25 °C	$\theta_{EB}$	176	°C/W
Thermal resistance, junction emitter to case	at 25 °C	$\theta_{EC}$	208	°C/W
Thermal resistance, junction detector to board	at 25 °C	$\theta_{DB}$	67	°C/W
Thermal resistance, junction detector to case	at 25 °C	$\theta_{DC}$	134	°C/W
Thermal resistance, junction emitter to junction detector	at 25 °C	$\theta_{ED}$	310	°C/W
Thermal resistance, case to ambient	at 25 °C	$\theta_{CA}$	2180	°C/W

**Note**

- The thermal model is represented in the thermal network below. Each resistance value given in this model can be used to calculate the temperatures at each node for a given operating condition. The thermal resistance from board to ambient will be dependent on the type of PCB, layout and thickness of copper traces. For a detailed explanation of the thermal model, please reference Vishay's thermal characteristics of optocouplers application note.

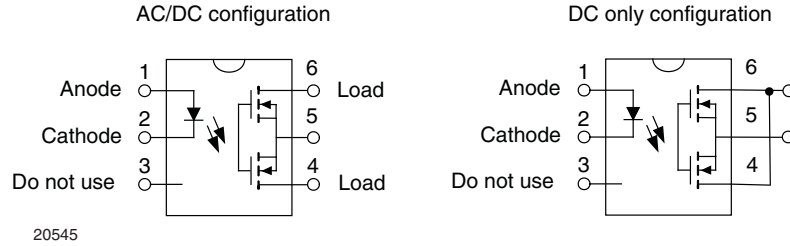


<b>ELECTRICAL CHARACTERISTICS</b> ( $T_{amb} = 25\text{ °C}$ , unless otherwise specified)						
PARAMETER	TEST CONDITION	SYMBOL	MIN.	TYP.	MAX.	UNIT
<b>INPUT</b>						
LED forward current, switch turn-on	$I_L = 1\text{ A}$ , $V_L \leq 0.5\text{ V}$ , $t = 10\text{ ms}$	$I_{Fon}$		0.5	2	mA
LED forward current, switch turn-off	$V_L = 60\text{ V}$ , $I_L < 1\text{ }\mu\text{A}$	$I_{Foff}$	50			$\mu\text{A}$
LED reverse current	$V_R = 5\text{ V}$	$I_R$			10	$\mu\text{A}$
LED forward voltage	$I_F = 10\text{ mA}$	$V_F$	1	1.3	1.5	V
<b>OUTPUT</b>						
On-resistance (AC/DC)	$I_F = 10\text{ mA}$ , $I_L = 1\text{ A}$	$R_{ON}$		0.18	0.25	$\Omega$
On-resistance (DC only)	$I_F = 10\text{ mA}$ , $I_L = 2\text{ A}$	$R_{ON}$		0.05	0.07	$\Omega$
Off-state leakage current	$I_F = 0\text{ mA}$ , $V_L = 60\text{ V}$	$I_{LEAK}$			1	$\mu\text{A}$

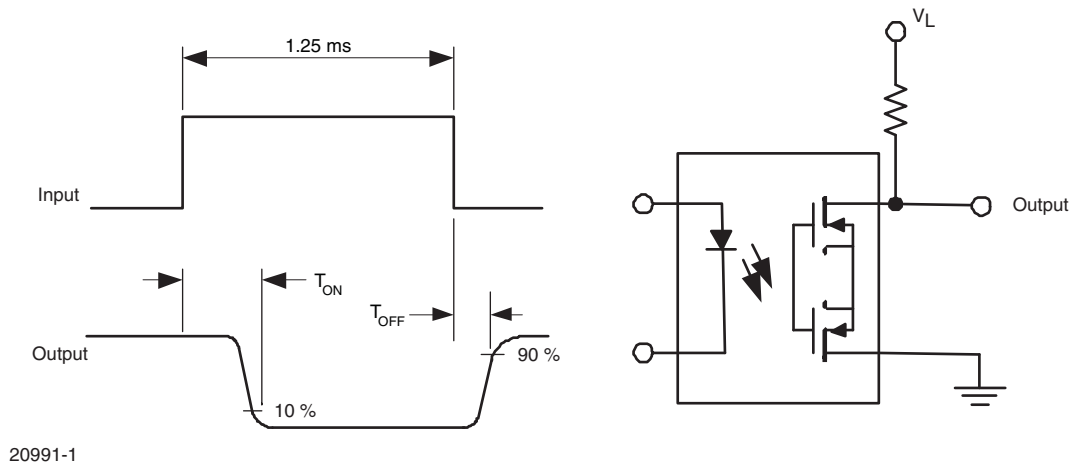
**Note**

- Minimum and maximum values are testing requirements. Typical values are characteristics of the device and are the result of engineering evaluations. Typical values are for information only and are not part of the testing requirements.

## PIN CONFIGURATION



SWITCHING CHARACTERISTICS (AC/DC CONNECTION)						
PARAMETER	TEST CONDITION	SYMBOL	MIN.	TYP.	MAX.	UNIT
Turn-on time	$I_F = 10 \text{ mA}$ , $V_L = 30 \text{ V}$ , $I_L = 200 \text{ mA}$	$t_{on}$		370	800	$\mu\text{s}$
Turn-off time	$I_F = 10 \text{ mA}$ , $V_L = 30 \text{ V}$ , $I_L = 200 \text{ mA}$	$t_{off}$		50	800	$\mu\text{s}$
Turn-on time	$I_F = 10 \text{ mA}$ , $V_L = 5 \text{ V}$ , $I_L = 1 \text{ A}$	$t_{on}$		550		$\mu\text{s}$
Turn-off time	$I_F = 10 \text{ mA}$ , $V_L = 5 \text{ V}$ , $I_L = 1 \text{ A}$	$t_{off}$		18		$\mu\text{s}$



SAFETY AND INSULATION RATINGS						
PARAMETER	TEST CONDITION	SYMBOL	MIN.	TYP.	MAX.	UNIT
Climatic classification	IEC 68 part 1			40/85/21		
Pollution degree	DIN VDE 0109			2		
Tracking resistance (comparative tracking index)	Insulation group IIIa	CTI	175			
Highest allowable overvoltage	Transient overvoltage	$V_{IOTM}$	8000			$V_{peak}$
Maximum working insulation voltage	Recurring peak voltage	$V_{IORM}$	890			$V_{peak}$
Insulation resistance at 25 °C	$V_{IO} = 500\text{ V}$	$R_{IS}$			$\geq 10^{12}$	$\Omega$
Insulation resistance at $T_S$	$V_{IO} = 500\text{ V}$	$R_{IS}$			$\geq 10^9$	$\Omega$
Insulation resistance at 100 °C	$V_{IO} = 500\text{ V}$	$R_{IS}$			$\geq 10^{11}$	$\Omega$
Partial discharge test voltage	Method b, $V_{pd} = V_{IORM} \times 1.875$	$V_{pd}$			1669	$V_{peak}$
Isolation test voltage	1 s	$V_{ISO}$			5300	$V_{RMS}$
Safety limiting values - maximum values allowed in the event of a failure	Case temperature	$T_{SI}$		165		°C
	Input current	$I_{SI}$		150		mA
	Output power	$P_{SO}$		400		mW
Minimum external air gap (clearance distance)	Measured from input terminals to output terminals, shortest distance through air			$\geq 7$		mm
Minimum external tracking (creepage distance)	Measured from input terminals to output terminals, shortest distance path along body			$\geq 7$		mm

**Note**

- This SSR is suitable for "safe electrical insulation" only within the safety ratings. Compliance with the safety ratings shall be ensured by means of protective circuits.

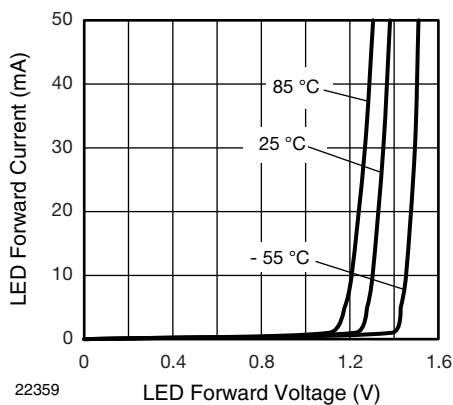
**TYPICAL CHARACTERISTICS** ( $T_{amb} = 25\text{ °C}$ , unless otherwise specified)


Fig. 2 - LED Forward Voltage vs. Current

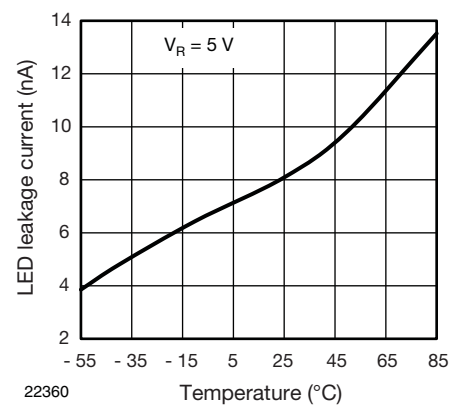


Fig. 3 - LED Leakage Current vs. Temperature

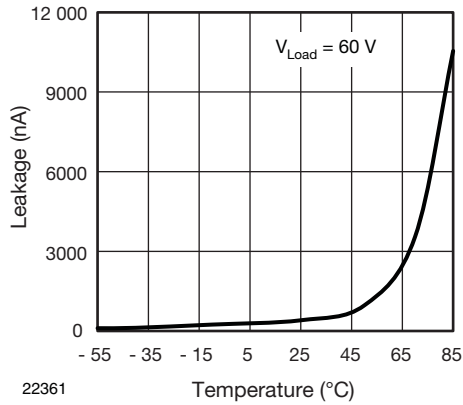


Fig. 4 - Output Leakage Current vs. Temperature

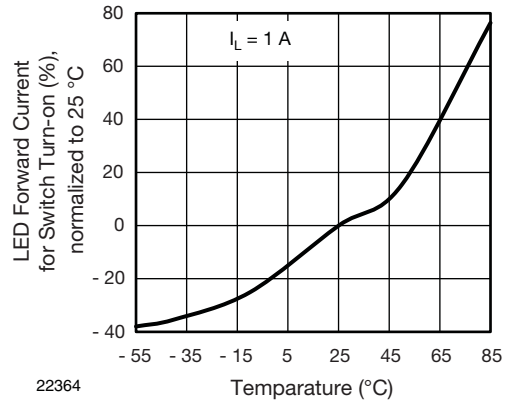


Fig. 7 - LED Current for Switch Turn-on vs. Temperature

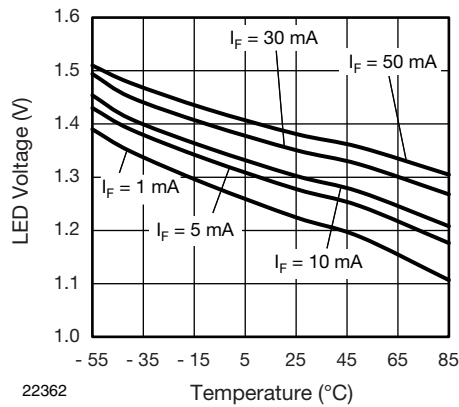


Fig. 5 - LED Voltage vs. Temperature

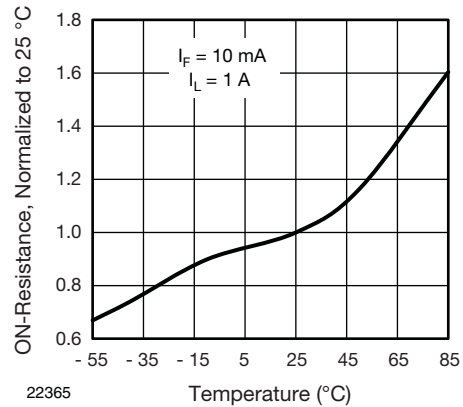


Fig. 8 - On-resistance vs. Temperature

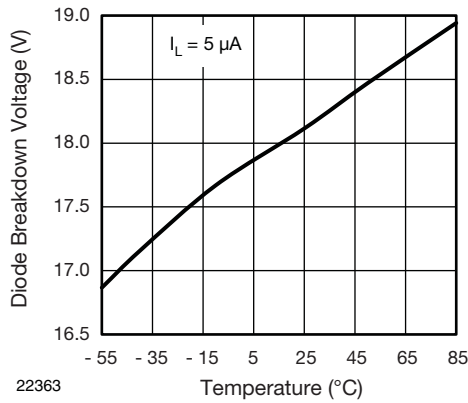


Fig. 6 - Diode Breakdown Voltage vs. Temperature

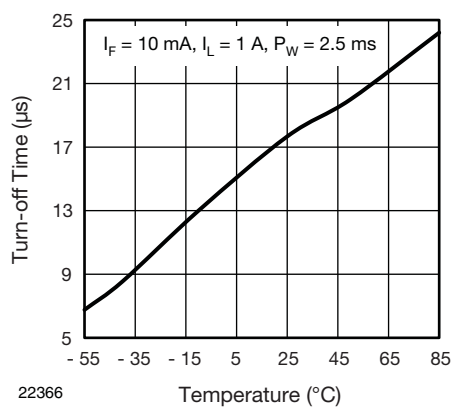


Fig. 9 - Turn-off Time vs. Temperature

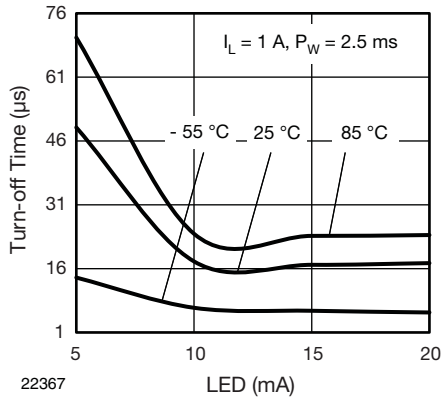


Fig. 10 - Turn-off Time vs. LED

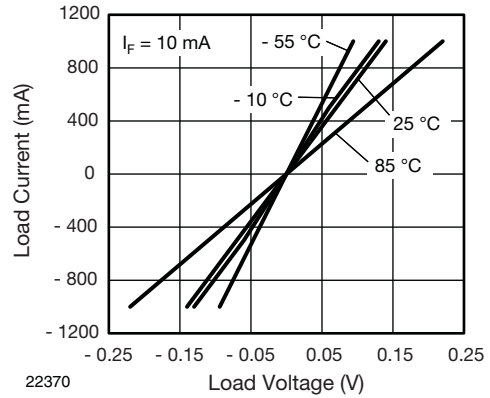


Fig. 13 - Load Current vs. Load Voltage

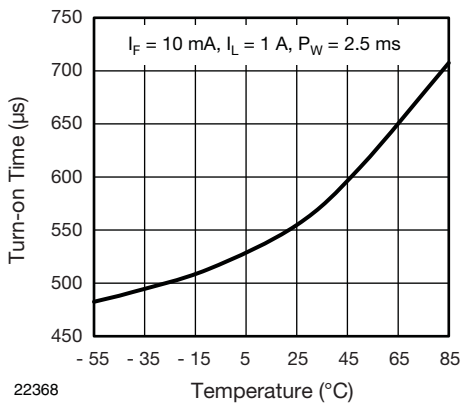


Fig. 11 - Turn-on Time vs. Temperature

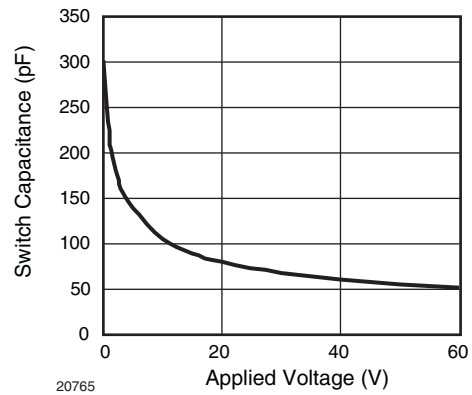


Fig. 14 - Switch Capacitance vs. Applied Voltage

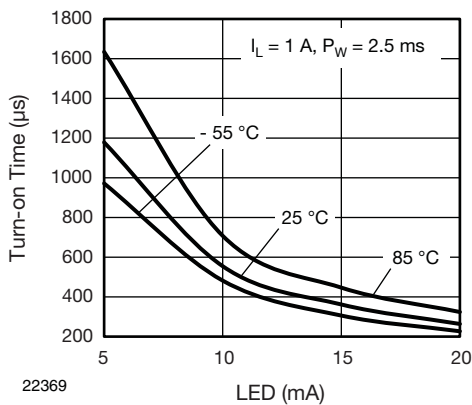


Fig. 12 - Turn-on Time vs. LED

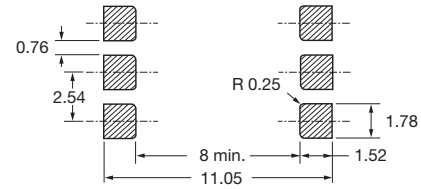
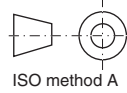
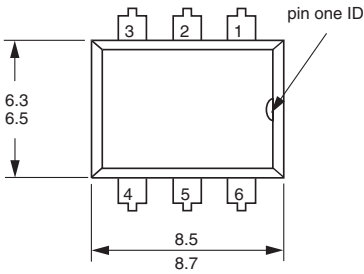
# VO14642AT, VO14642AABTR



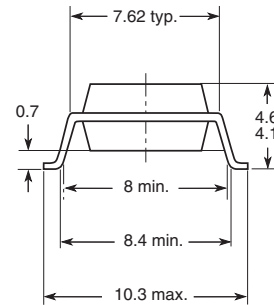
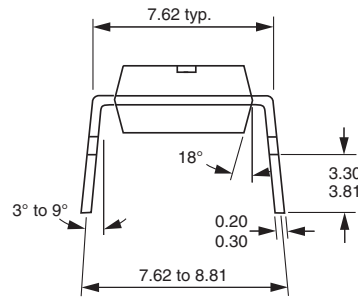
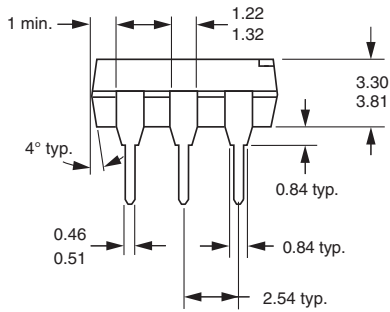
Vishay Semiconductors

1 Form A Solid State Relay

## PACKAGE DIMENSIONS in millimeters

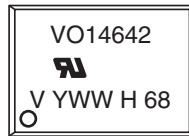


Option 7



i178014\_2

## PACKAGE MARKING



### Note

- Tape and reel suffix (TR) is not part of the package marking.





## **Disclaimer**

ALL PRODUCT, PRODUCT SPECIFICATIONS AND DATA ARE SUBJECT TO CHANGE WITHOUT NOTICE TO IMPROVE RELIABILITY, FUNCTION OR DESIGN OR OTHERWISE.

Vishay Intertechnology, Inc., its affiliates, agents, and employees, and all persons acting on its or their behalf (collectively, "Vishay"), disclaim any and all liability for any errors, inaccuracies or incompleteness contained in any datasheet or in any other disclosure relating to any product.

Vishay makes no warranty, representation or guarantee regarding the suitability of the products for any particular purpose or the continuing production of any product. To the maximum extent permitted by applicable law, Vishay disclaims (i) any and all liability arising out of the application or use of any product, (ii) any and all liability, including without limitation special, consequential or incidental damages, and (iii) any and all implied warranties, including warranties of fitness for particular purpose, non-infringement and merchantability.

Statements regarding the suitability of products for certain types of applications are based on Vishay's knowledge of typical requirements that are often placed on Vishay products in generic applications. Such statements are not binding statements about the suitability of products for a particular application. It is the customer's responsibility to validate that a particular product with the properties described in the product specification is suitable for use in a particular application. Parameters provided in datasheets and / or specifications may vary in different applications and performance may vary over time. All operating parameters, including typical parameters, must be validated for each customer application by the customer's technical experts. Product specifications do not expand or otherwise modify Vishay's terms and conditions of purchase, including but not limited to the warranty expressed therein.

Except as expressly indicated in writing, Vishay products are not designed for use in medical, life-saving, or life-sustaining applications or for any other application in which the failure of the Vishay product could result in personal injury or death. Customers using or selling Vishay products not expressly indicated for use in such applications do so at their own risk. Please contact authorized Vishay personnel to obtain written terms and conditions regarding products designed for such applications.

No license, express or implied, by estoppel or otherwise, to any intellectual property rights is granted by this document or by any conduct of Vishay. Product names and markings noted herein may be trademarks of their respective owners.