

# SHIMPO

## Digital Force Gauge

FGV - 0.5/1/2/5/10/20/50/100/200 XY

# Instruction Manual

Please read the entire manual before using your gauge.

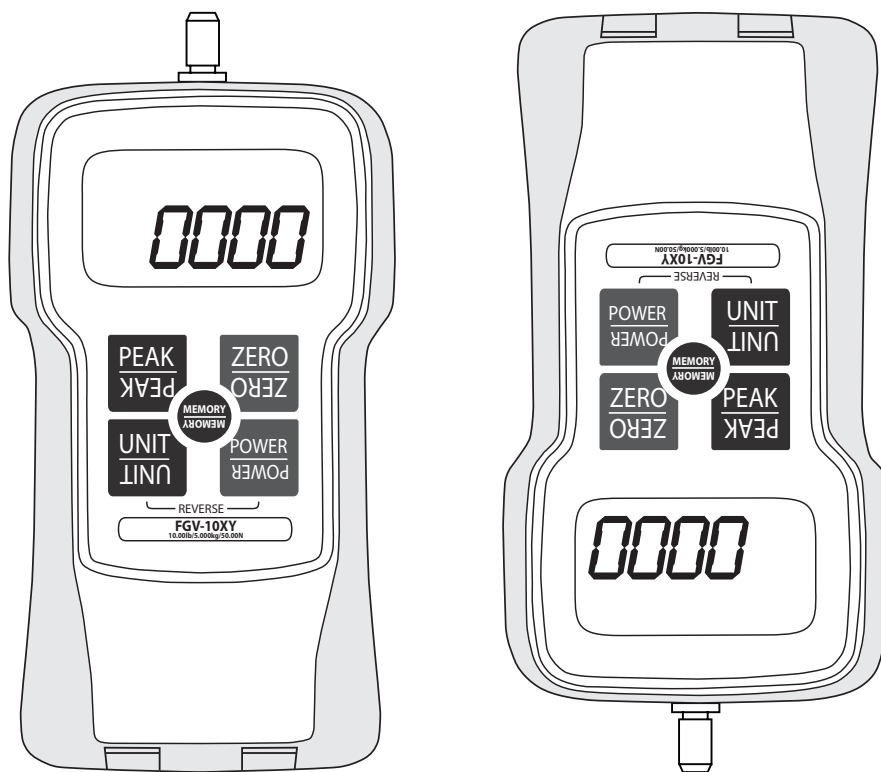

***DART 2.0***

NIDEC-SHIMPO CORPORATION

# Safety Precautions

Observe the following safety symbols throughout this manual.



Warning



Prohibited Actions



Important Instructions



Failure to follow the instructions in this manual may result in serious injury or death.



## Warning



Use appropriate safety equipment while performing tests with the FGV-XY.

Weighing large masses, performing break tests, and other uses may necessitate special safety equipment. Please contact your supervisor for the necessary safety equipment and test procedures.



Use of a broken, deformed, or damaged attachment or gauge is prohibited.

Contact your Shimpo dealer for information regarding replacement accessories, additional accessories, and repair.



## Caution



Loading the FGV-XY with a force greater than its rated capacity can damage the gauge.



OVR is displayed when the gauge is overloaded. Remove the load immediately to avoid damage. Any measurement during the OVR condition is not accurate.



## Caution



Only use the supplied AC adapter for charging the FGV-XY.

Use of a third party AC adapter will void the unit's warranty, and may cause circuit damage or fire.



Do not attempt to power your AC adapter with voltages other than 100-230V AC.

Fire and shock hazards may occur if used improperly.



Plug in the AC adapter firmly.

Loose connections can cause a fire or shock hazard.



Do not operate the FGV-XY or its AC adapter in wet conditions.

Shock hazards and malfunctions may occur.



Do not open, repair, or attempt to modify your FGV-XY.







Please contact your Shimpo dealer for information regarding repairs and modifications.







Unplug the AC adapter by grasping the plugs, and not the cables.

Unnecessary tension on the power chord may create a shock or fire hazard.

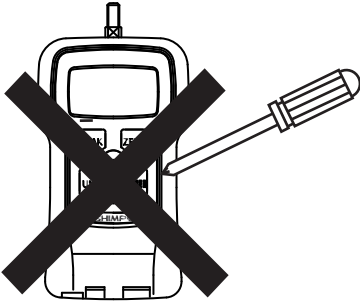
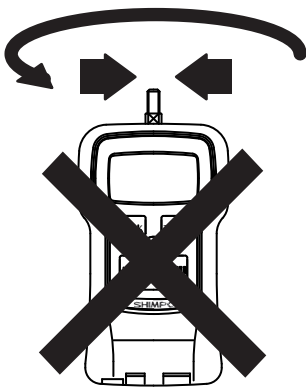
# Safety Precautions

 <b>Caution</b>	
 <p>Keep the AC adapter's plugs, and the FGV-XY's power jack clean. Dirt or corrosion may create a shock or fire hazard.</p>	 <p>Do not use your FGV-XY in the following conditions or environments:</p> <ul style="list-style-type: none"> <li>·In or around water</li> <li>·In direct sunlight</li> <li>·In high humidity</li> <li>·In excessively dusty or oily environments</li> <li>·In caustic or corrosive environments</li> <li>·In flammable or volatile environments</li> </ul>
 <p>Clean your FGV-XY with a damp cloth and a solution of mild soap and water.</p> <p>Do not use caustic or abrasive chemicals when cleaning your FGV-XY.</p>	 <p>Operate your FGV-XY within 0~40° C (-32~104° F).</p> <p>Use of your FGV-XY outside this temperature range may cause malfunctions or damage.</p>
 <p>To ensure consistent accuracy, it is recommended that your FGV-XY be calibrated at a minimum of once per year.</p> <p>Contact your Shimpo dealer for information regarding calibration.</p>	 <p>Operate your FGV-XY within 35~85% RH.</p> <p>Use of your FGV-XY outside this humidity range may cause malfunctions or damage.</p>

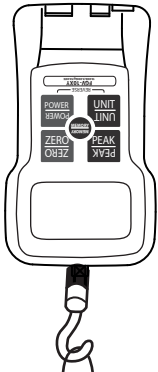
 <b>Caution</b>	
<p>Do not press the buttons on the FGV-XY with any objects other than your fingers.</p> 	<p>Do not apply side loads or torque to your FGV-XY.</p>   <p>Your FGV-XY has an internal mechanism which helps prevent overloading when the measured force is applied in line with the sensor shaft. Applying a twisting, bending or perpendicular force to the shaft will result in permanent damage, and inaccurate measurements.</p>
<p>Avoid dropping your FGV-XY.</p>  <p>Your FGV-XY is not designed to withstand dynamic loads. A fall of sufficient height can permanently damage your gauge.</p>	<p>Do not use your force gauge in, or around water.</p>  <p>Your FGV-XY is not waterproof, and is not designed for wet, or excessively humid locations.</p>
<p>Measuring small loads.</p> <p>Turn off Tracking function before measuring small forces. Refer to section "4.4. Tracking" for more information.</p> 	

# Table of Contents

<u>1. Product Features</u>	<u>4</u>		
<u>2. Standard Accessory Checklist</u>	<u>4</u>		
<u>3. Parts of your FGV-XY</u>	<u>5</u>		
3.1 Main Unit	5		
3.2 Display	6		
3.2.1 LCD Sections	6		
3.2.2 Numeric Display	6		
3.2.3 Display Indicators	6		
3.2.4 MAX/MIN display	6		
<u>4. Setup</u>	<u>7</u>		
4.1 Battery	7		
4.2 Measurement Accessories	7		
4.3 Hanger	7		
4.4 Tracking	8		
4.5 Functions	8		
4.5.1 Measurement Polarity: f01	9		
4.5.2 Display Update Time: f02	9		
4.5.3 Auto Power Off: f03	9		
4.5.4 RS-232C Baud Rate: f04	10		
4.5.5 Response Time: f05	10		
4.5.6 External Output: f06	10		
4.6 Reversing the Display	11		
<u>5. Features and Operation</u>	<u>11</u>		
5.1 Overview of Operation	11		
5.2 Measuring Mode	12		
5.2.1 Standard Measuring Mode	12		
5.2.2 Peak Mode	12		
5.3 Change Display Unit	12		
5.4 Tare	12		
5.5 Comparator	13		
5.5.1 Comparator Overview	13		
5.5.2 Comparator / Memory Settings Mode	13		
5.5.3 Setting HI Limit	13		
5.5.4 Setting LO Limit	14		
5.5.5 Comparator Display	14		
5.5.6 Comparator Output	14		
		5.6 Memory	14
		5.6.1 Setting the Memory Mode	16
		5.6.2 Recording Memory Data	17
		5.6.2.1 Continuous Mode	17
		5.6.2.2 Single Mode	17
		5.6.2.3 Standard Mode	17
		5.7 Reviewing Memory Data	18
		5.7.1 Continuous Mode Memory	18
		5.7.1.1 Accessing Memory Data	18
		5.7.1.2 Statistics Data	19
		5.7.2 Single Mode Memory	20
		5.7.2.1 Accessing Memory Data	20
		5.7.2.2 Statistics Data	21
		5.7.3 Standard Mode Memory	22
		5.7.3.1 Accessing Memory Data	22
		5.7.3.2 Statistics Data	23
		5.8 Clearing the Memory	23
		5.8.1 Clearing the Last Record	23
		5.8.2 Clearing All Memory	24
		5.8.3 No Recorded Data	24
		5.9 USB Communication	24
		5.9.1 Features of ToriemonUSB	24
		5.9.2 Download ToriemonUSB	24
		5.9.3 Battery Life and USB	24
		<u>6. External Data Port</u>	<u>25</u>
		6.1 Pin Assignment	25
		6.2 RS-232C Output	25
		6.2.1 RS-232C Interface	25
		6.2.2 RS-232C Communication Commands	26
		6.2.3 Connection between FGV and Host	27
		6.3 Analog Output	27
		6.4 Overload/Comparator Output	27
		<u>7. Frequently Asked Questions</u>	<u>28</u>
		7.1 Troubleshooting	28
		7.2 Technical Inquiries	28
		<u>8. Support</u>	<u>29</u>
		8.1 Repair and Calibration	29
		8.2 Warranty	29
		<u>9. Specifications and Dimensions</u>	<u>29</u>

# 1. Product Features

- Nickel – Hydrogen battery allows for long periods of use.

→ 4.1 Battery

- Data can be downloaded to PC via USB.

→ 5.9 USB Communication

- 1000 points of data storage.

→ 5.6. Memory

- Comparator feature for pass/fail testing.

→ 5.5. Comparator

- Broad range of capacities: 2.000N (200.0gf, 8oz) ~ 1000N (100.0kgf, 200lb).

→ 9 Specifications and Dimensions

- Reversible display with reversed key pad for easy upside down reading.

→ 4.6. Reverse the Display

- One touch operation to change the measurement unit N, kg(g), Lb(oz).

→ 5.3. Change Display Unit

- Measures peak values for tension and compression.

→ 5.2.2. Peak Hold Mode

- High speed measurement rate of 1000 times/second.

→ 5.2.2. Peak Hold Mode

- Display update time as fast as 20 times/second.

→ 5.2.1 Standard Measuring Mode

# 2. Standard Accessory Checklist

- Before use, please confirm that the following items are included in the carrying case.

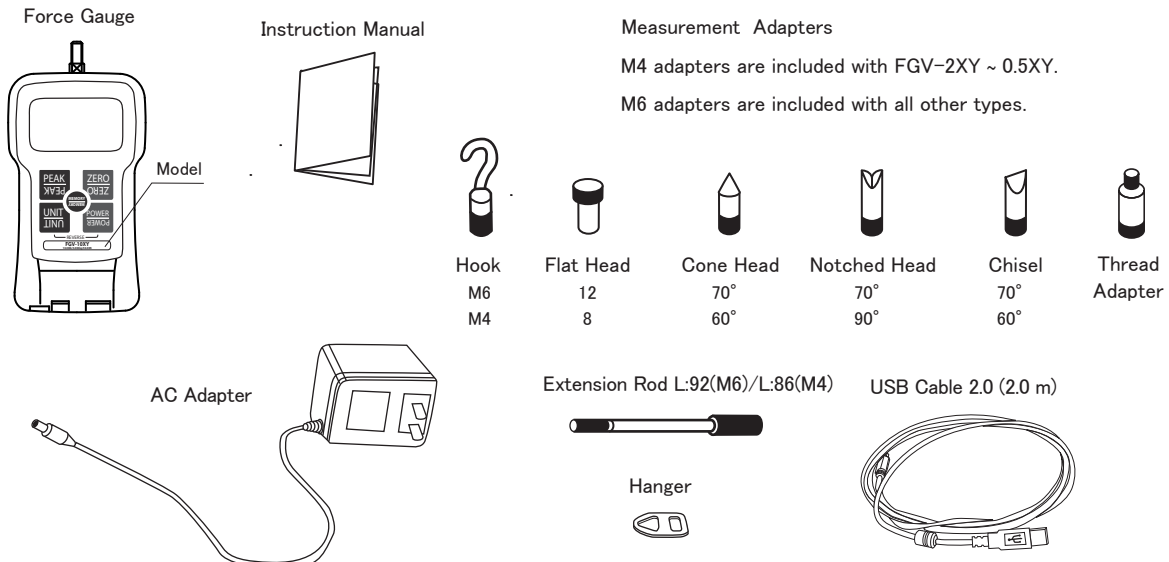

## 3. Parts of your FGV-XY

### 3.1. Main Unit

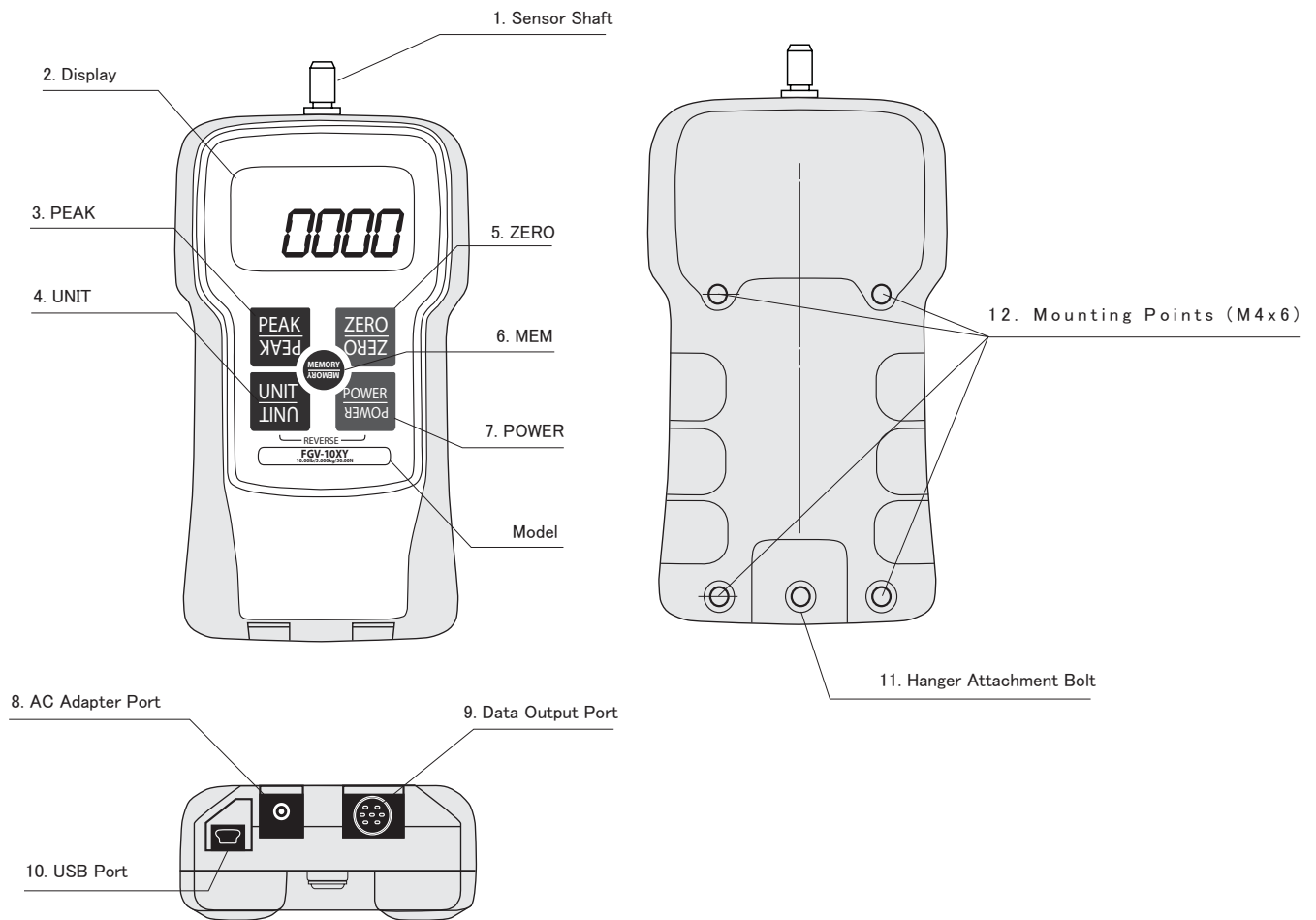

1.	Sensor Shaft	Apply your force in line with this threaded shaft. Use the included attachments for a your testing application.
2.	Display	LCD screen is unit's main information display.
3.	PEAK	Press PEAK to change measuring modes
4.	UNIT	Press UNIT to switch to available measurement units.
5.	ZERO	Press ZERO in Standard mode to tare gauge. Pressing ZERO in Peak mode will clear the current peak value.
6.	MEM	Press MEM in standard mode to activate measurement recording
7.	POWER	Press POWER to turn gauge on and off.
8.	AC Adapter Port	Port used for the provided AC adapter.
9.	Data Output Port	Port used for data output options.
10.	USB Port	Port used to connect gauge to PC through USB.
11.	Hanger Attachment Bolt	Bolt secures the provided hanger attachment.
12.	Threaded Holes	Thread holes are used to attach gauge to a fixture or stand.

## 3.2 Display

### 3.2.1 LCD Sections

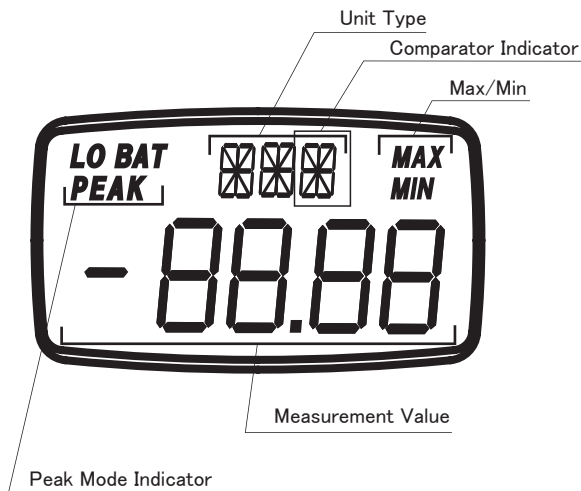

### 3.2.2 Numeric Display

The default setting for the four digit display shows compression loads as a positive force and tension loads as a negative force. To reverse these settings, showing compression loads as negative and tension loads as positive, see section 4.5 for setting f01.

### 3.2.3 Display Indicators



The availability of kg or g, and lb or oz is determined by the gauge's capacity.



OVR is displayed when the load has exceeded the gauge's capacity by 20%.

PWR is displayed 1 minute before the gauge automatically powers off.

Δ and ∇ are shown when the comparator is ON. See section 5.5.5 for more information.



LO BAT flashes when the battery needs to be charged. Plug in the supplied AC adapter.

BAT is displayed when the battery is being charged.

PEAK is displayed when the unit is in Peak mode. The presence of "-" confirms negative Peak mode.

### 3.2.4 MAX/MIN Display

When displaying statistical data in memory mode, the following indicators are shown.

The polarity setting, f01, will determine which directional force is considered positive and negative. See section 4.5.



Maximum  
(Positive)

Maximum  
(Negative)

Minimum  
(Positive)

Minimum  
(Negative)

## 4. Setup

### 4.1 Battery



Do not charge with non-standard AC adapter.

Use only the AC adapter supplied with your FGV-XY. Do not use a third party adapter. Doing so could cause a fire or shock hazard. Contact your Shimpo dealer if you need a new adapter.

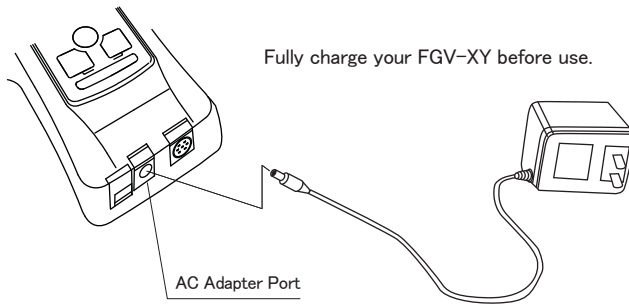

1. To charge your FGV-XY, firmly plug the supplied AC adapter into the gauge's power port, and then plug the adapter into a wall outlet.
  - Charging will start automatically, and "BAT" will show on the LCD.
  - Charging will stop automatically, and "BAT" will disappear from the LCD.
  - Charge time: Up to 16 Hours.
  - Operating time: Approximately 8 Hours.

2. To conserve battery life, only charge the unit when "LO BAT" is displayed. Charging the unit before the battery is close to empty will decrease the battery's life.

3. The FGV-XY is fully operable while charging.

4. When the battery's power is low, "LO BAT" will display on the LCD. If the unit is not connected to the AC adapter, the gauge will power off in approximately one minute.

### 4.2 Measurement Accessories

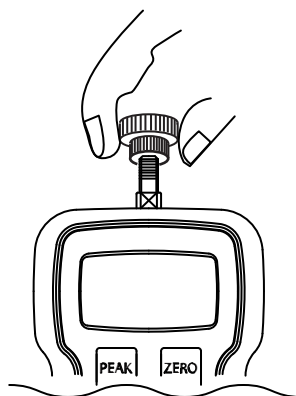

Select the measurement adapter for your application, and lightly hand tighten the accessory onto the sensor shaft. Over tightening an accessory with your hand or a tool can cause permanent damage to the gauge.



Do not tighten an attachment with any tool. Do not over tighten.



Do not use a broken, bent, or damaged attachment.

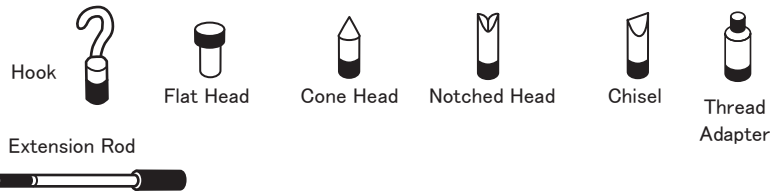

### 4.3 Hanger

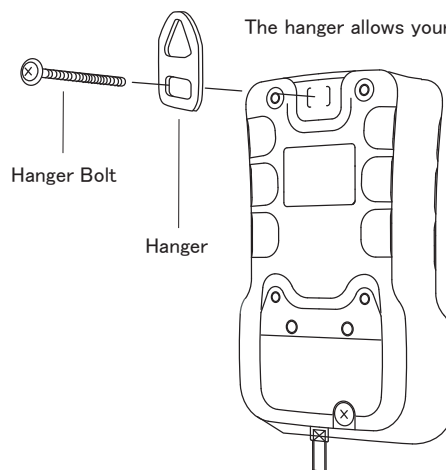

The hanger allows your FGV-XY to be hung from a fixture or winch.



Be sure that your fixture, stand, or winch can support the gauge, and the applied load.

The hanger is shaped specifically to fit onto the gauge. Remove the hanger bolt, place the square end of the hanger in the recessed area on the gauge, and tighten the hanger bolt.



## 4.4 Tracking

The FGV-XY uses a load cell and strain gauge as its force sensor. The sensor is affected by environmental changes such as temperature and humidity. The Tracking function, which is active by default, helps to negate the effects of these changes. Tracking can cause errors when measuring very small forces. It is recommended that you turn off the Tracking function when measuring these smaller forces. With the gauge's power off, hold PEAK and UNIT. Press POWER, and keep holding PEAK and UNIT until "oFF" is displayed. Repeat the process to turn Tracking back on. Instead of "oFF", "SEt" will be displayed.

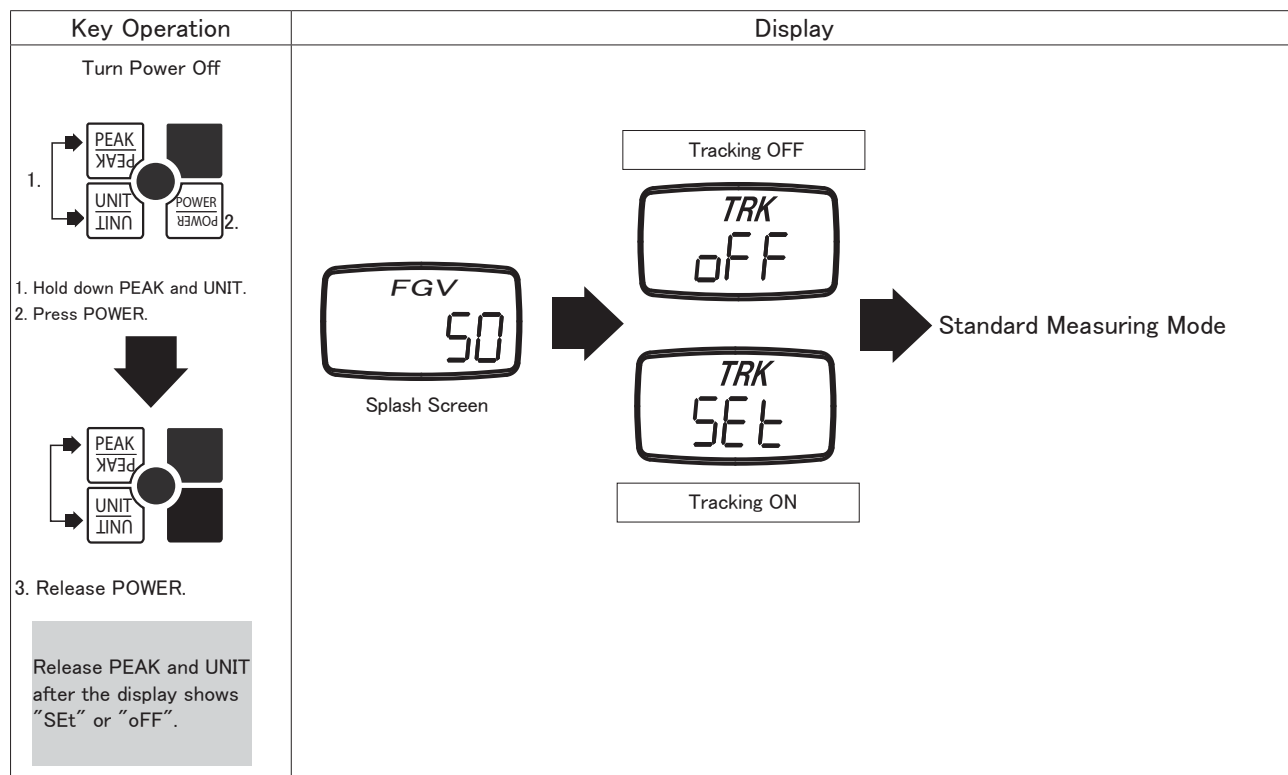

## 4.5 Functions

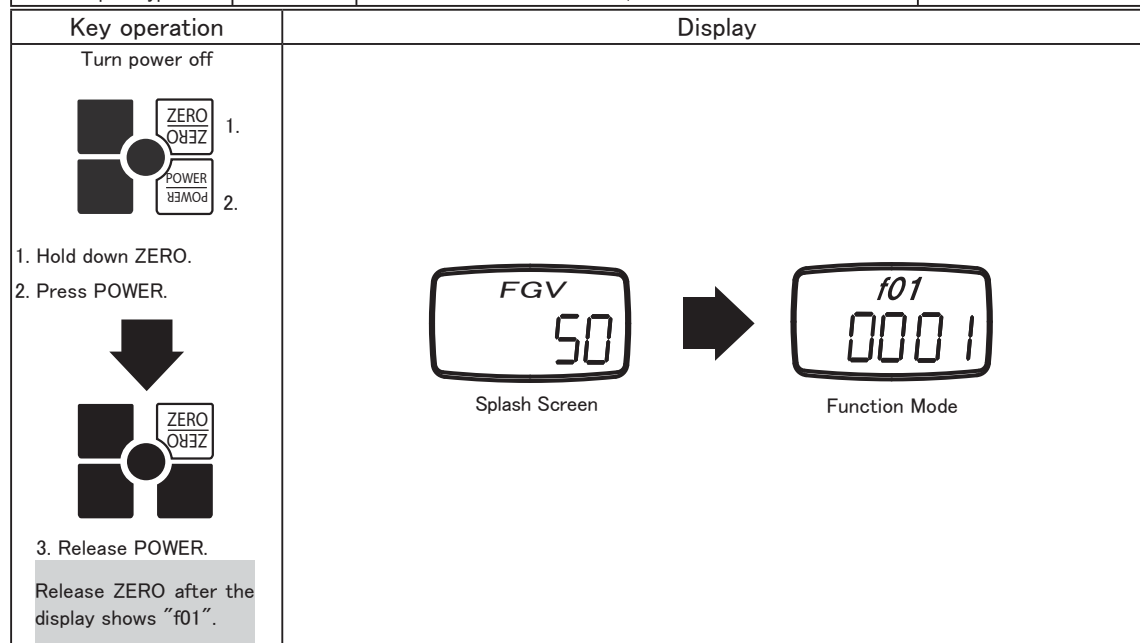

The following settings are available in Function mode.

Setting	Unit	Options	Default
Measurement Polarity	f01	-0001(minus), 0001 (plus)	0001
Display Update Time	f02	1, 2, 3, 5, 10, 20 (times/second)	3
Auto Power Off	f03	10 (10 minutes), oFF (always on)	10
RS-232C Baud Rate	f04	2400, 4800, 9600, 19200 bps	2400
Response Time	f05	3, 20, 150 (msec)	3
Output Type	f06	ovEr, Hi-Lo	ovEr

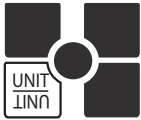
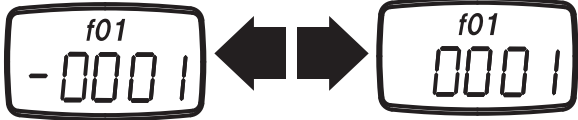

### 4.5.1 Measurement Polarity: f01

This function allows you to change whether compression is shown as a positive or negative force. Once the compression display has been changed, the tension display will then read as the opposite of the compression. Press UNIT to change the setting, PEAK to save and move to the next function, or ZERO to save and finish.



Key Operation	Display
 <p>Press UNIT to change.</p>	<p>Negative Compression      Positive Compression</p> 
	Save the current setting, and return to the standard measuring mode.
	Save the current setting, and move to f02.

### 4.5.2 Display Update Time: f02

This function allows you to change the rate at which the display is updated.

The update times available are 1, 2, 3, 5, 10, and 20 times a second.

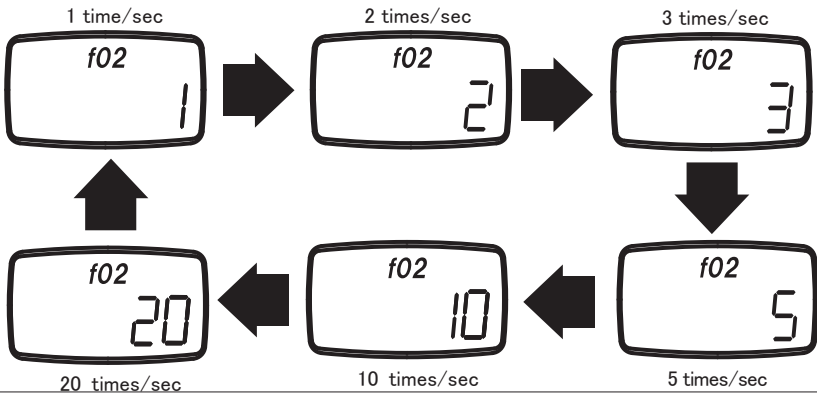
Press UNIT to cycle through the settings, PEAK to save and move to the next function, or ZERO to save and finish.

Key Operation	Display
 <p>Press UNIT to cycle through the available settings.</p>	
	Save the current setting, and return to the standard measuring mode.
	Save the current setting, and move to f03.



### 4.5.3 Auto Power Off: f03

If the gauge is on and there is no activity for 10 minutes\*, the unit automatically powers off to conserve battery power.

This option may be disabled, and is automatically disabled when connected to the AC adapter.

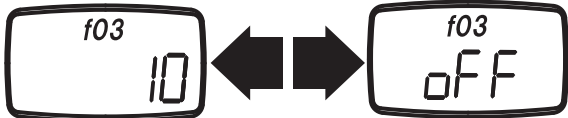

Press UNIT to change the setting, PEAK to save and move to the next function, or ZERO to save and finish.

\*Activity is defined as key operations, RS-232C communication, USB communication, or changes in measurement value.

Key Operation	Display
 <p>Press UNIT to change.</p>	<p>Auto Power Off: 10 Minutes      Auto Power Off: disabled</p> 
	Save the current setting, and return to the standard measuring mode.
	Save the current setting, and move to f04.

## 4.5.4 RS-232C Baud Rate: f04

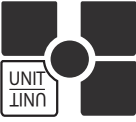
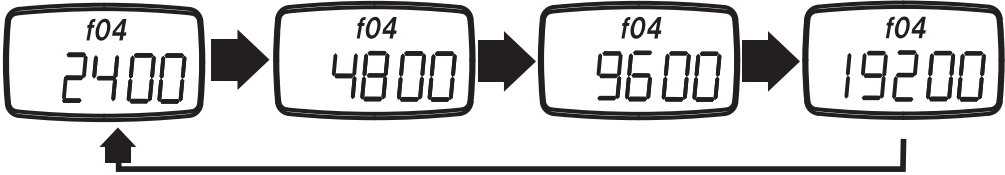
This function allows you to change the RS-232C communication rate. The available baud rates are 2400, 4800, 9600, and 19200 bps. Press UNIT to change the setting, PEAK to save and move to the next function, or ZERO to save and finish.



Key Operation	Display
 <p>Press UNIT to cycle through the available settings.</p>	<p>2400 bps      4800 bps      9600 bps      19200 bps</p> 
	Save the current setting, and return to the standard measuring mode.
	Save the current setting, and move to f05.

## 4.5.5 Response Time: f05

The response time function smooths out the gauge's sampling, and adjusts the sampling period accordingly.

The available response times are 3, 20, and 150 msec.

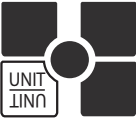
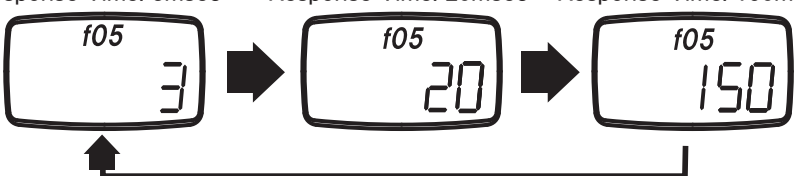
Press UNIT to change the setting, PEAK to save and move to the next function, or ZERO to save and finish.

Key Operation	Display
 <p>Press UNIT to cycle through the available settings.</p>	<p>Response Time: 3msec      Response Time: 20msec      Response Time: 150msec</p> 
	Save the current setting, and return to the standard measuring mode.
	Save the current setting, and move to f06.

The response time shows 90% of the step input.

Sampling and analog output rates are linked to this setting.

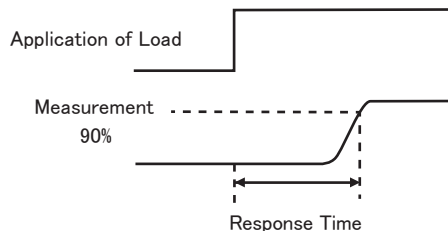

Response time	Sampling period · Analog output update period
3 msec	1 msec
20 msec	1 msec
150 msec	6.7 msec



## 4.5.6 External Output: f06

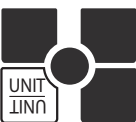
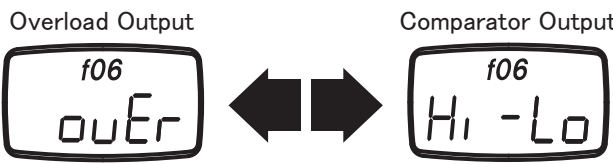

This function allows user to change between Overload and Comparator type output.\*

Press UNIT to change the setting, PEAK to save and move to the next function, or ZERO to save and finish.

Key Operation	Display
 <p>Press UNIT to cycle through the available settings.</p>	<p>Overload Output      Comparator Output</p> 
	Save the current setting, and return to the standard measuring mode.
	Save the current setting, and return to f01.

## 4.6 Reversing the Display

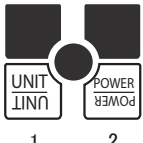
If you have mounted your FGV-XY upside down, or are holding the unit upside down during measurement, the display may be reversed for readability.

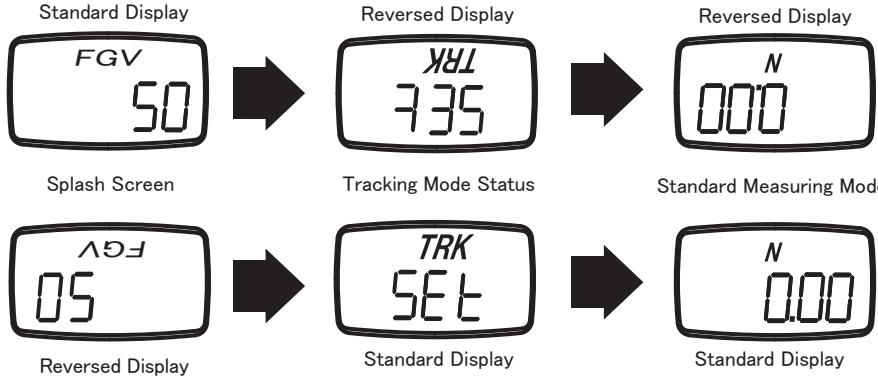
Key Operation	Display
<p>Turn Power Off</p>  <p>1. Hold down UNIT. 2. Press POWER.</p>  <p>Release POWER.</p> <div style="border: 1px solid black; padding: 5px; margin-top: 10px;"> <p>Release UNIT after the the Tracking Mode status screen is displayed in reverse.</p> </div>	 <p>Standard Display → Reversed Display → Reversed Display</p> <p>Splash Screen → Tracking Mode Status → Standard Measuring Mode</p> <p>Reversed Display → Standard Display → Standard Display</p>

## 5. Features and Operation

### 5.1 Overview of Operation

#### Basic Operations

Key	Operation
POWER	Turns the FGV-XY ON and OFF
ZERO	Tares the gauge in Standard mode. Clears a peak value in Peak mode.
PEAK	Switches between Standard, Positive Peak, and Negative Peak mode.
UNIT	Cycles between the available measurement units.
MEM	Stores a value in memory, or starts recording values.

#### Special Operations

Operation	Key	Key Functions
Tracking ON / OFF	PEAK+UNIT POWER	Turn POWER off. Press PEAK and UNIT simultaneously and hold. Press and release POWER. Release PEAK and UNIT after "SET" or "oFF" is displayed.
Enter Function Mode	ZERO + POWER	Turn POWER off. Press ZERO and hold. Press and release POWER. Release ZERO after "f01" is displayed.  While in Function Mode: UNIT: Changes the current setting. PEAK: Saves current setting, and advances to the next the function. ZERO: Saves the current setting, and returns to Standard mode.
Reverse Display	UNIT + POWER	Turn POWER off. Press UNIT and hold, then press and release POWER. Release UNIT after the display has reversed.
Display Memory Data	MEM + POWER	Turn POWER off. Press MEM and hold, then press POWER. Release MEM after the display shows memory data.  While in the Memory display: UNIT: Cycles through the statistical data for the current memory block. PEAK: Returns to Standard mode. ZERO: Deletes one memory block. Hold ZERO to delete all memory data. MEM: Advances to the next memory block.
Comparator/ Memory Settings	PEAK + POWER	Turn POWER off. Press PEAK and hold, then press POWER. Release PEAK after the "HI" setting is displayed.  While in Comparator/Memory Settings: UNIT: Selects HI/LO setting, advances digits, changes polarity, cycles memory modes. PEAK: Cycles through HI, LO, MEM settings. ZERO: Cycles through the digits in HI/LO settings. MEM: Saves settings and returns to Standard mode.

## 5.2 Measuring Mode

The two measurement modes available are Standard and Peak.

### 5.2.1 Standard Measuring Mode

This mode shows the current force applied, tension/compression, on the sensor shaft.

1. Turn on the FGV-XY by pressing POWER.
2. Press ZERO to tare the gauge.
3. If necessary, press and release PEAK until NO "PEAK" on display.

The measurement displayed is the average of the measured samples\* over the display's update time.

The display update time is set to 3 times/second by default. This can be increased up to 20 times/second. Refer to section 4.5.2 for more information.

\*This is dependent on the Response Time function, f05. See section 4.5.5 for more information.

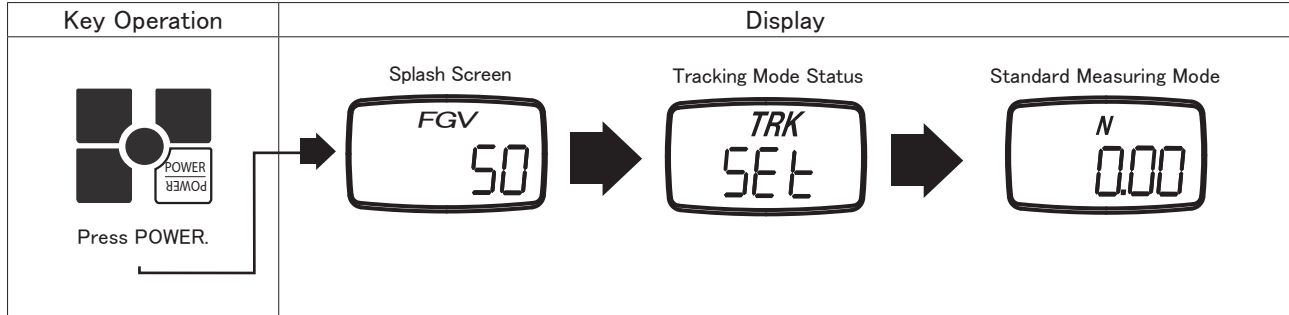

### 5.2.2 Peak Mode

Peak mode displays the greatest force in both the positive and negative direction. Sampling time is 1ms.\*

Press PEAK to change from standard measuring mode, to positive peak mode, to negative peak mode.

In the positive peak mode, "PEAK" is displayed.

In the negative peak mode, "PEAK" and "-" are displayed.

\*This is dependent on the Response Time function, f05. See section 4.5.5 for more information.

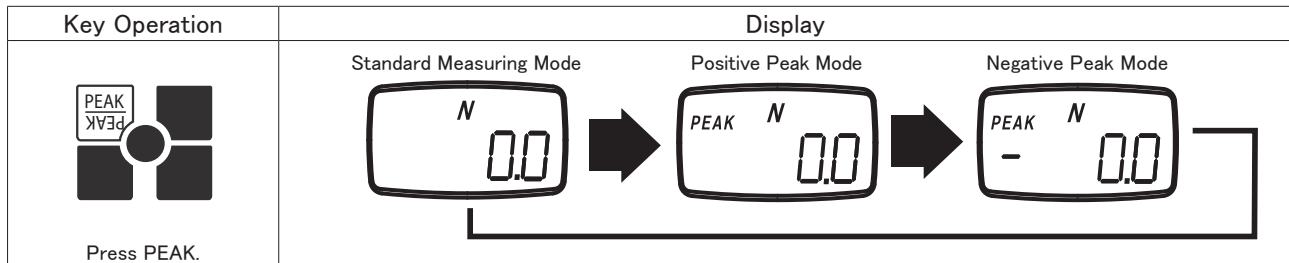

⚠ While in either peak mode, ZERO will clear the current peak value, but will not tare the gauge.

## 5.3 Change Display Unit

To change the measurement unit, press UNIT. The units of measure available on each gauge depends on its capacity.

See the specification sheet, section 9, to see which units are available for a particular model gauge.

## 5.4 Tare

⚠ Press ZERO to reset the measured value. This will allow the gauge to ignore any force currently applied to the sensor shaft. The ignored, or tared, force is still counted with regards to the gauge's overload condition.

Overload will occur when the force applied to the sensor shaft exceeds the gauge's rated capacity by 20%. Stop measuring, and remove the load immediately to avoid permanent damage to the gauge. Any measurements taken in the overload range are not accurate.

Tare is automatically performed when the gauge is first powered on.

## 5.5 Comparator

### 5.5.1 Compatrator Overview

The Comparator function allows you to create conditions for Go/No Go testing. A high(HI), and low(LO) force limit may be set so that the FGV-XY's display will show when a measurement is not within the HI and LO settings. In addition, the output port will respond relative to the display. See section 6.4 regarding the comparator output.

**!** The FGV-XY must be in Comparator mode, and not Overload mode to use the following settings. See section 4.5.6 regarding the output mode.

### 5.5.2 Comparator / Memory Settings Mode

Turn POWER off, press PEAK and hold. Press POWER and release (release PEAK after "HI" is displayed).

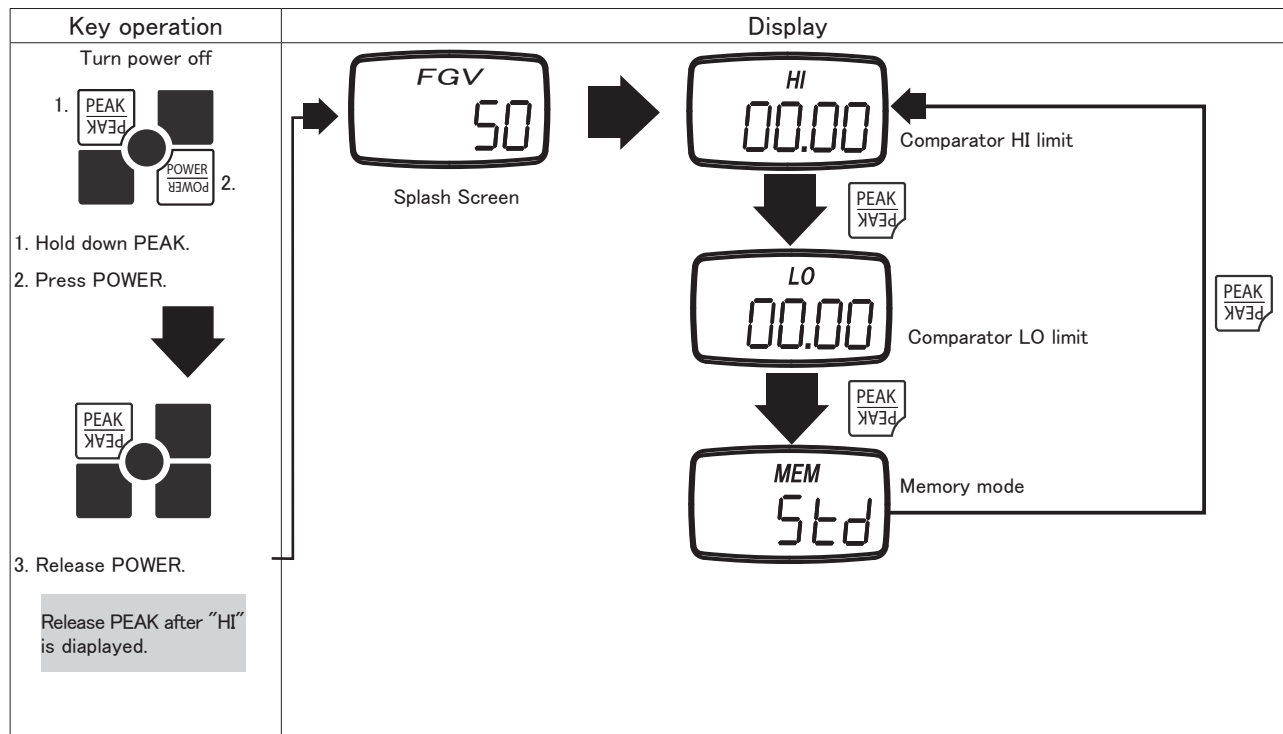

Setting	Display	Content	Default factory setting
Comparator HI limit	HI	Value for the HI limit*	0
Comparator LO limit	LO	Value for the LO limit*	0
Memory mode	MEM	Memory mode(Standard, Single, Continuous)	Std

\* When HI and LO are set to 00.00 the Comparator function is disabled.







### 5.5.3 Setting HI Limit



1. Press UNIT to select the HI setting. The digits will start flashing.
2. Press UNIT again to change the polarity.
3. Choose the digit to change by pressing ZERO.
4. Press UNIT to increase the selected digit to the desired value.
5. Repeat steps 3 and 4 until the desired value and polarity are correct.
6. Press PEAK. This saves the HI limit and displays the LO limit.
7. Press MEM if you are finished with the Comparator and Memory settings.

**!** The Comparator function's limits can be set outside of the FGV-XY's working range. This may cause unpredictable results, and is not recommended.

**!** The values entered for the HI and LO settings are displayed in the measurement units last used in Standard mode.

**!** The absolute value of the HI limit may never be lower than the absolute value of the LO limit.

Key operation	Status	Display
	Changes polarity	
	Selects the next digit.	
	Changes the selected digit.	

Key operation	Status
	Move to LO limit setting.
	Register the setting, then move to standard measuring mode.
	Turn power off without any change.



## 5.5.4 Setting LO Limit

The procedure to set the HI limit is used to set the LO limit. Section 5.5.3 contains this information.

 The absolute value of the LO limit may never be higher than the absolute value of the HI limit.

LO limit setting mode







Key	Operation
	Move to memory mode.
	Register the setting, then move to standard measuring mode.
	Turn power off without any change.

## 5.5.5 Comparator Display

The following symbols are shown when the comparator function is active.

- △ Measuring value > HI limit
- ▽ Measuring value < LO limit

 In order for the Comparator function to display, the comparator output option must be set in function f06. See section 4.5.6 regarding this setting.

	Data < HI limit Data > LO limit	Data > HI limit	Data < LO limit
Comparator Display Possibilities			

## 5.5.6 Comparator Output

The Comparator function also allows control of an alarm or automated process through its data output port.

When the measured value is greater than the HI limit, the corresponding photo-couple is triggered.

When the measured value is lower than the LO limit, the corresponding photo-couple is triggered.

 In order for the Comparator function to display, the comparator output option must be set in function f06. See section 4.5.6 regarding this setting.

 For connection and circuit information, pertaining to the Comparator output, see section 6.4.

## 5.6 Memory

The FGV-XY has three memory modes.

Continuous memory	Allows the recording of up to 1000 data points. The recording starts when you push MEM, and stops when you push MEM. In addition, the following statistics, gathered between that start and stop, are recorded: positive maximum value, negative maximum value, positive minimum value, negative minimum value, positive peak value, negative peak value, average value, standard deviation.
Single memory	Allows the recording of up to 100 data points. Every time MEM is pressed, the value shown on the display is memorized. If the unit is in Standard mode then the current measured value is recorded. In Peak mode, the unit records the displayed peak value. In addition, the following statistics are recorded: positive maximum value, negative maximum value, positive minimum value, negative minimum value, average value, standard deviation.
Standard memory	Allows the recording of up to 50 data points. The recording process is similar to Continuous mode. MEM starts the recording, and stops the recording. The measured value, when MEM is pushed the second time, is recorded as a point. The following statistics, gathered between the start and stop, are recorded: positive maximum value, negative maximum value, positive minimum value, negative minimum value.

Memory terms defined:

Measurement value: The current displayed value in Standard mode.

Positive maximum value (+MAX): Maximum value in the positive direction.

Negative maximum value (-MAX): Maximum value in the negative direction.

Positive minimum value (+MIN): Minimum value in the positive direction.

Negative minimum value (-MIN): Minimum value in the negative direction.

Average value (AVE): Average of the recorded measurement values.  $\sum X_i/n$

Standard deviation (DEV): Standard deviation of the recorded measurement values.  $\sqrt{\sum (\bar{X}_i - X)^2/n}$

Positive peak value: Largest value in the positive direction. (This value is sampled at 1000 times/second).

Negative peak value: Largest value in the negative direction. (This value is sampled at 1000 times/second)

Last measurement value (LST): The last measurement value displayed at the corresponding time.

Example of +MAX, -MAX, +MIN, -MIN (Continuous memory mode)

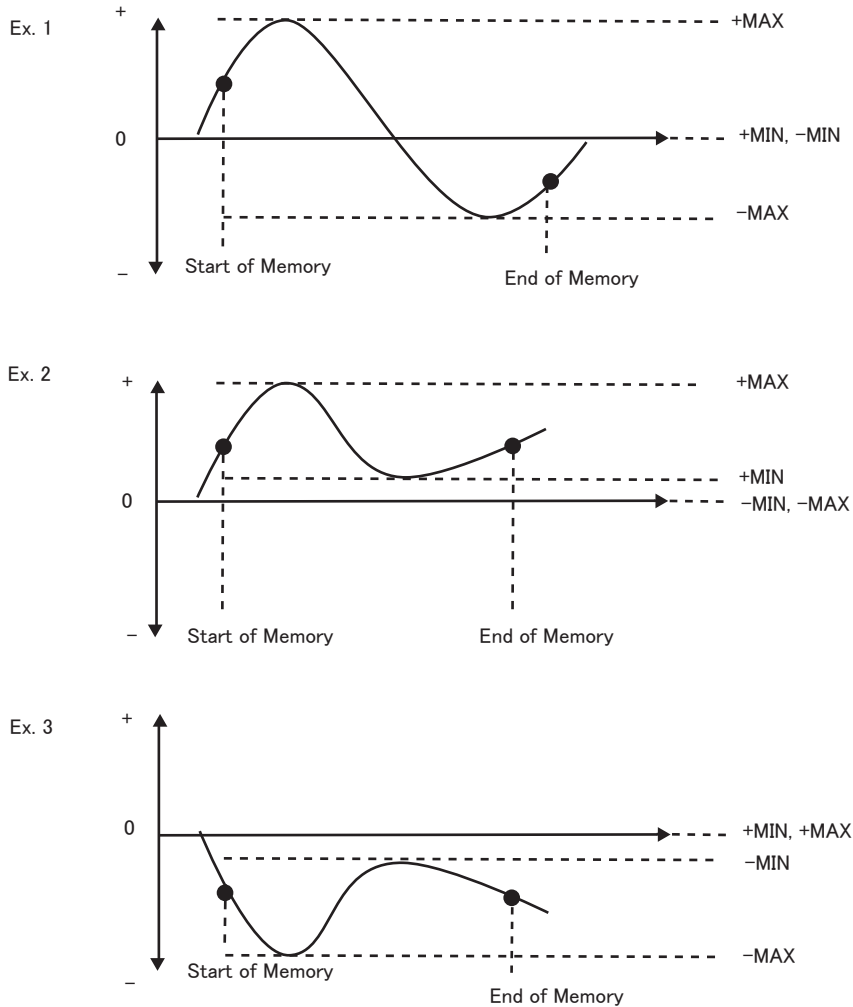



## 5.6.1 Setting the Memory Mode

Turn the POWER off.

Press PEAK and hold, then press and release POWER. The display will show the HI Comparator limit.

Press PEAK twice to display the current memory mode.

Press UNIT to cycle the Memory mode.

Press MEM to save and exit.

There are following items are found in the Comparator/Memory mode settings.

Item	Display	Content	Default factory setting
Comparator HI limit setting	HI	Displays the current HI limit.	0
Comparator LO limit setting	LO	Displays the current LO limit.	0
Memory mode setting	MEM	Displays the current Memory mode.	Std

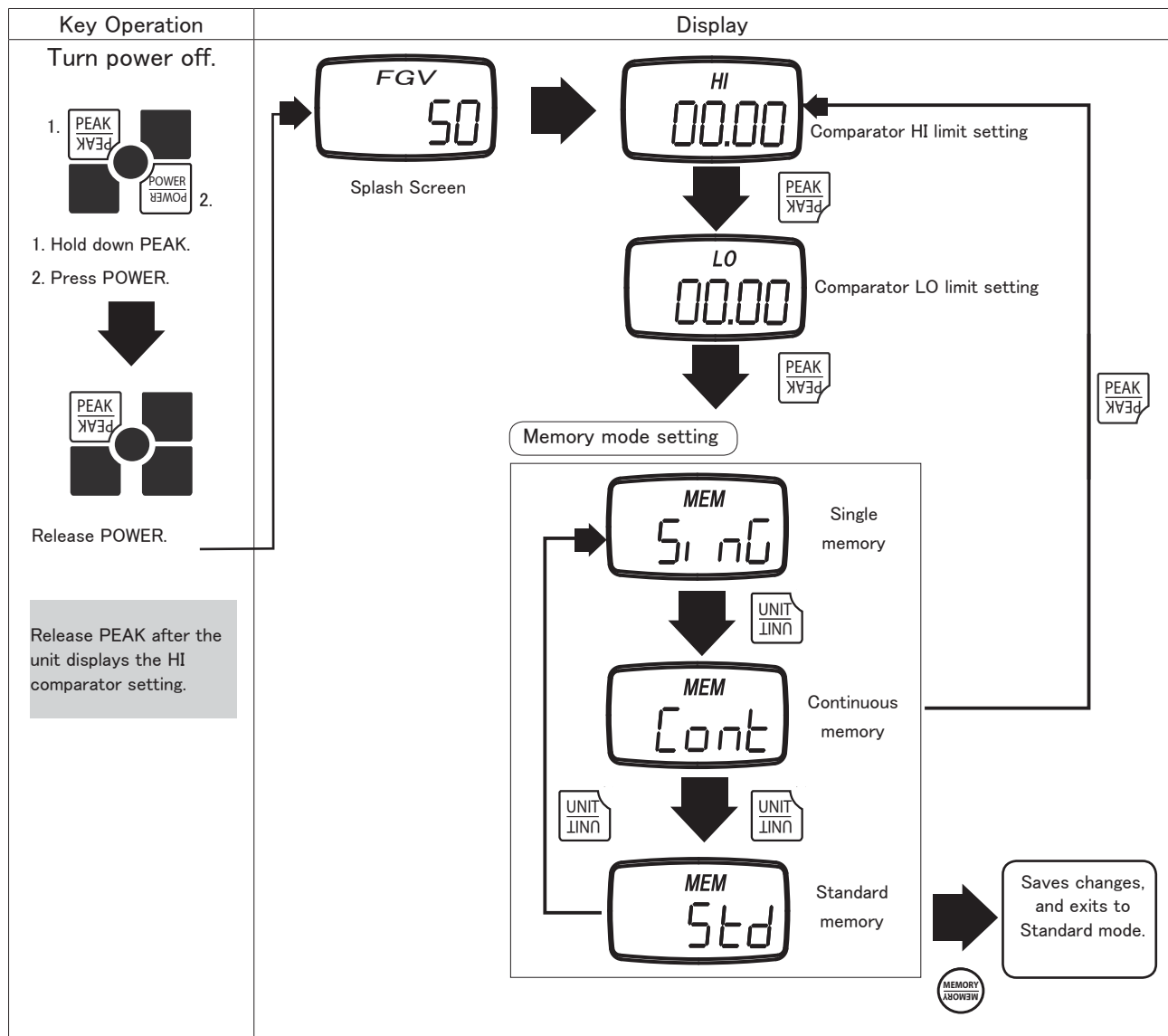

## 5.6.2 Recording Memory Data

The following procedures explain how to activate memory recording for each memory mode.

### 5.6.2.1 Continuous Mode

1. In continuous measurement mode, press MEM to start the recording. The letter M will appear and start blinking. Press M to stop the recording.
2. If 1000 points of data are recorded, the display will show FULL and return to standard measurement mode.

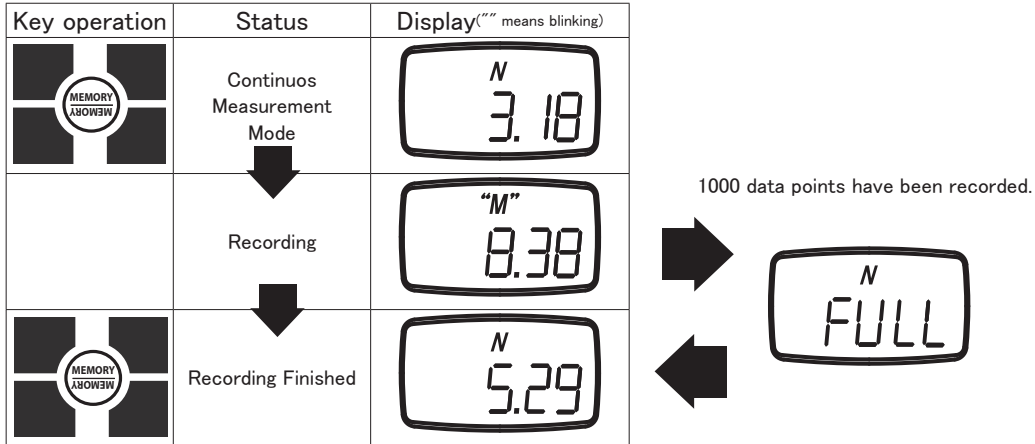

### 5.6.2.2 Single Mode

1. In single measurement mode, press MEM. The letter M will appear to show that one data point has been recorded.
2. If 100 data points have been collected, the screen will show FULL, and return to standard measurement mode.

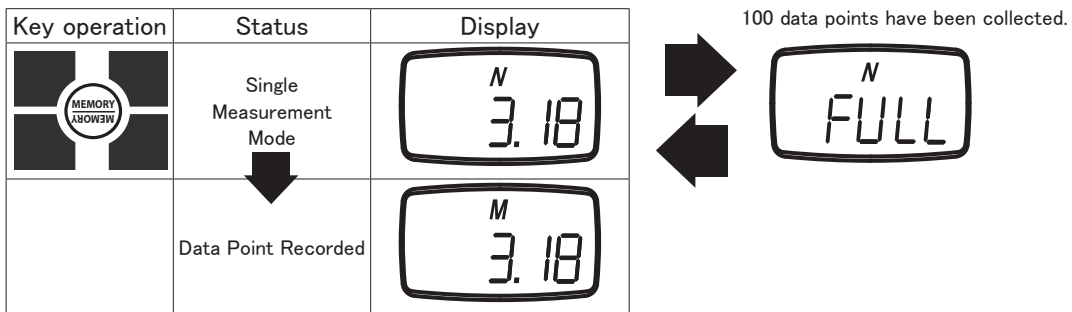

### 5.6.2.3 Standard Mode

1. In Standard Measurement mode, press MEM. The letter M will start blinking, which shows that maximum, minimum, and peak values are being recorded.
2. Press MEM to stop the recording, and store the last measurement value.

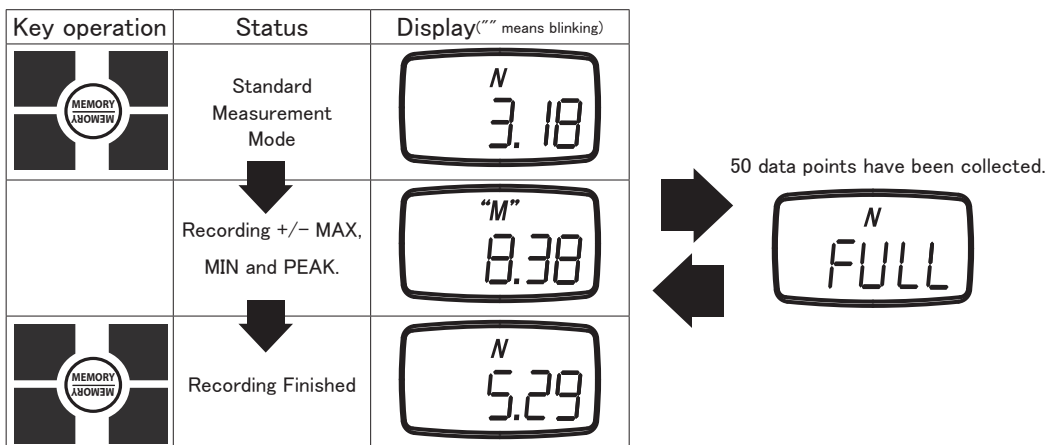





## 5.7 Reviewing Memory Data

### 5.7.1 Continuous Mode Memory

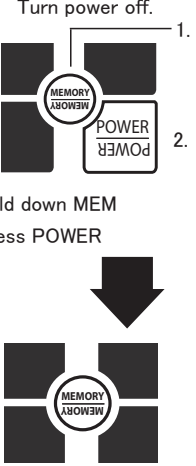
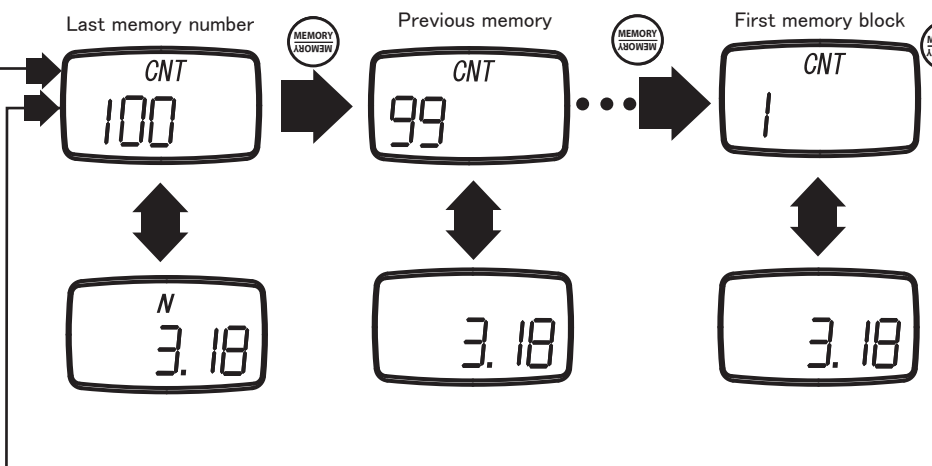
#### 5.7.1.1 Accessing Memory Data

1. Turn the POWER off. Press MEM and hold, then press and release POWER. Release MEM when you see "CNT" on the display. The unit will alternate between showing the data block number, and the recorded measurement value of that block.
2. Press MEM to review the previous data block recorded.
3. Press UNIT to cycle through the available recorded statistics. In Continuous mode the available statistics are as follows: positive maximum value, negative maximum value, positive minimum value, negative minimum value, positive peak value, negative peak value, average value, standard deviation. This is covered in greater detail in the next section, 5.7.1.2.
4. Press PEAK to output the recorded memory via RS-232C. Refer to section 6.2 regarding RS232C communication.

Key operation	Display
<p>Turn power off.</p>  <p>1. Hold down MEM 2. Press POWER</p> <p>3. Release POWER</p> <p>Release MEM after "CNT" is displayed.</p>	 <p>Last memory number CNT 100 N 3.18</p> <p>Previous memory CNT 99 3.18</p> <p>First memory block CNT 1 3.18</p>
	<p>Deletes the current data block, but only if you have the last block selected.</p>
	<p>Cycles through the available statistics.</p>
	<p>Transfers the recorded memory data via RS232C, and exits memory mode.</p>
	<p>Powers down the FGV-XY.</p>

## 5.7.1.2 Statistics Data



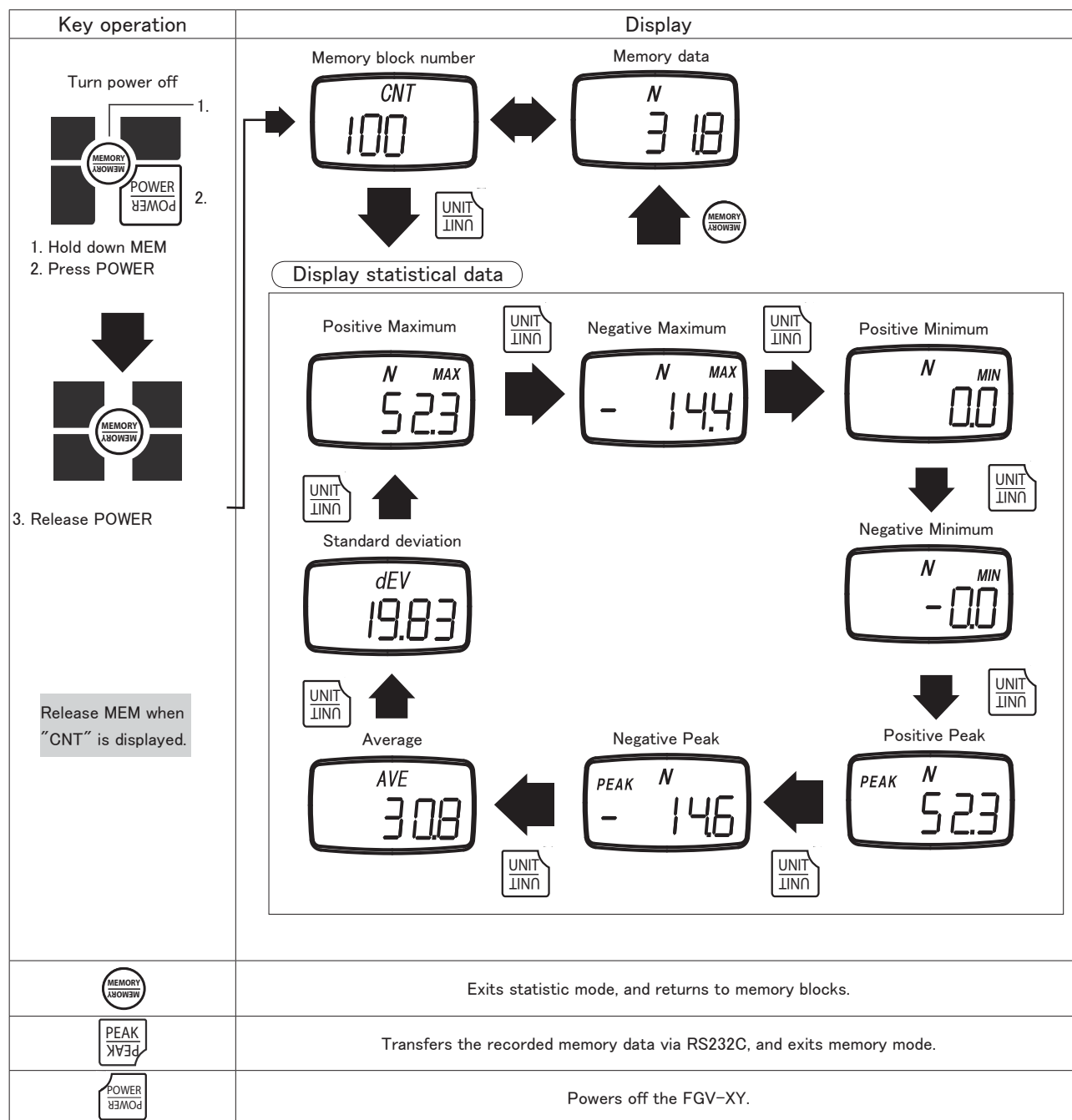

- When in memory mode, UNIT will cycle through the available statistics data.
- Each press of UNIT will switch between the following items: positive maximum value, negative maximum value, positive minimum value, negative minimum value, positive peak value, negative peak value, average value, standard deviation.
- Press MEM to exit to the recorded measurement values.
- Press PEAK key to output the recorded memory via RS-232C. Refer to section 6.2 regarding RS232C communication.

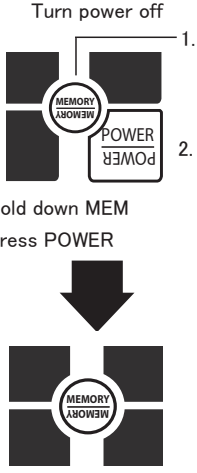
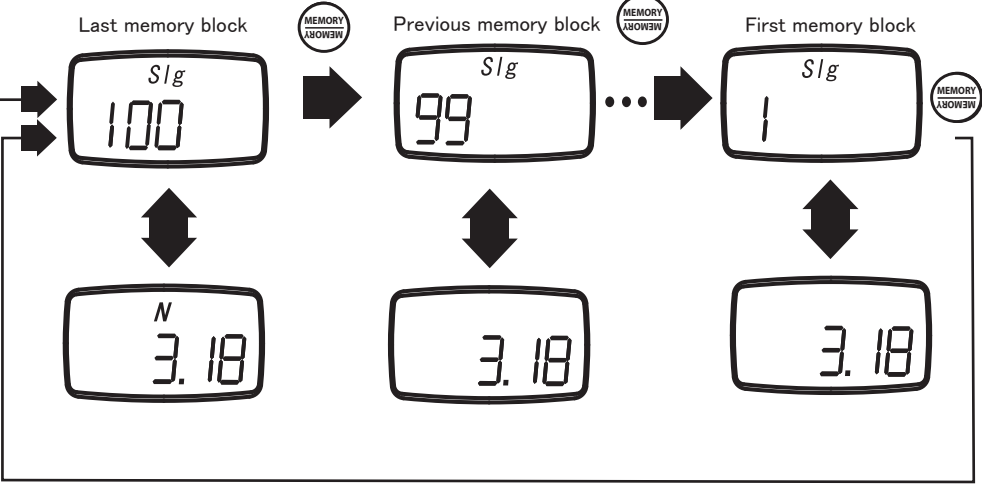

## 5.7.2 Single Mode Memory

### 5.7.2.1 Accessing Memory Data

1. Turn the POWER off. Press MEM and hold, then press and release POWER. Release MEM when you see "Slg" on the display. The unit will alternate between showing the data block number and the recorded measurement value of that block.
2. Press MEM to review the previous data block recorded.
3. Press UNIT to cycle through the available recorded statistics. In Single mode the available statistics are as follows: positive maximum value, negative maximum value, positive minimum value, negative minimum value, average value, standard deviation. This is covered in greater detail in the next section, 5.7.2.2.
4. Press PEAK to output the recorded memory via RS-232C. Refer to section 6.2 regarding RS232C communication.

Key operation	Display
<p>Turn power off</p>  <p>1. Hold down MEM 2. Press POWER</p> <p>Release POWER</p> <p>Release MEM after the display shows "CNT".</p>	 <p>Last memory block</p> <p>Previous memory block</p> <p>First memory block</p>
	<p>Deletes the current data block, but only if you have the last block selected.</p>
	<p>Cycles through the available statistics.</p>
	<p>Transfers the recorded memory data via RS232C, and exits memory mode.</p>
	<p>Powers down the FGV-XY.</p>

## 5.7.2.2 Statistics Data



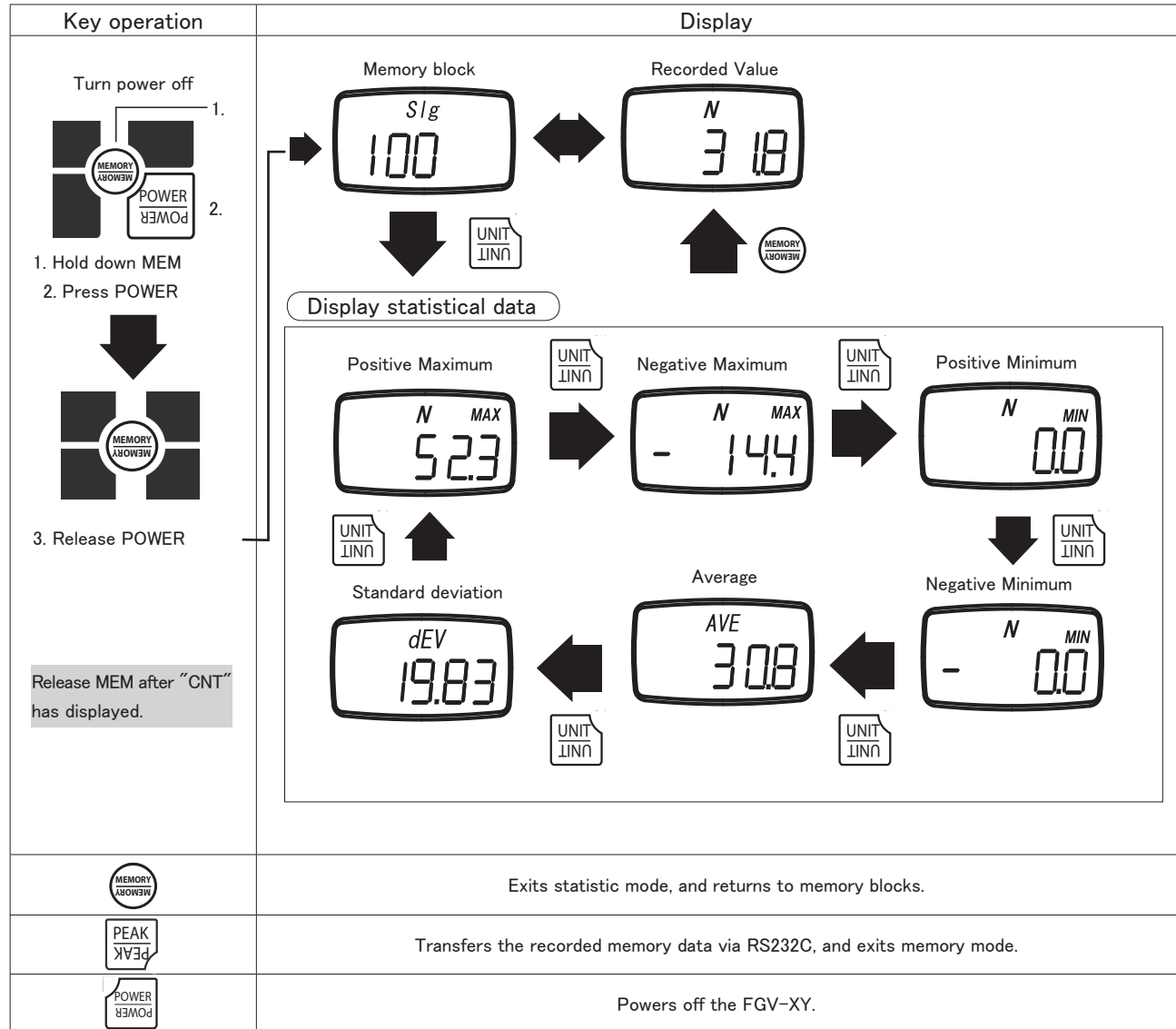

1. When in memory mode, UNIT will cycle through the available statistics data.
2. Each press of UNIT will switch between the following items: positive maximum value, negative maximum value, positive minimum value, negative minimum value, average value, standard deviation.
3. Press MEM to exit to the recorded measurement values.
4. Press PEAK key to output the recorded memory via RS-232C. Refer to section 6.2 regarding RS232C communication.

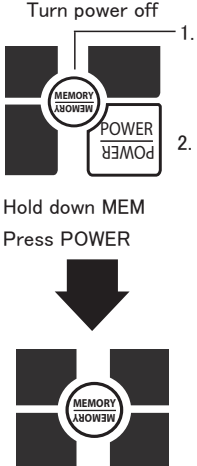
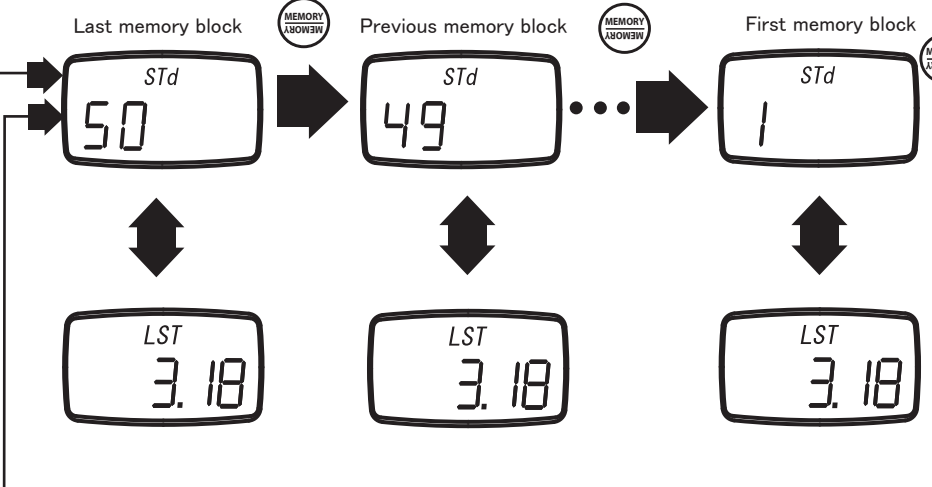

## 5.7.3 Standard Mode Memory

### 5.7.3.1 Accessing Memory Data

1. Turn the POWER off. Press MEM and hold, then press and release POWER. Release MEM when you see "STd" on the display. The unit will alternate between showing the data block number, and the recorded measurement value of that block.
2. Press MEM to review the previous data block recorded.
3. Press UNIT to cycle through the available recorded statistics. In Standard mode, the available statistics are as follows: positive maximum value, negative maximum value, positive minimum value, negative minimum value. This is covered in greater detail in the next section, 5.7.3.2.
4. Press PEAK to output the recorded memory via RS-232C. Refer to section 6.2 regarding RS232C communication.

Key operation	Display
<p>Turn power off</p>  <p>1. Hold down MEM 2. Press POWER</p> <p>3. Release POWER</p> <p>Release MEM when "CNT" is displayed.</p>	 <p>Last memory block      Previous memory block      First memory block</p> <p>STd      STd      STd</p> <p>50      49      1</p> <p>LST      LST      LST</p> <p>3.18      3.18      3.18</p>
	<p>Deletes the current data block, but only if you have the last block selected.</p>
	<p>Cycles through the available statistics.</p>
	<p>Transfers the recorded memory data via RS232C, and exits memory mode.</p>
	<p>Powers down the FGV-XY.</p>

## 5.7.3.2 Statistics Memory Data

- When in memory mode, UNIT will cycle through the available statistics data.
- Each press of UNIT will switch between the following items: positive maximum value, negative maximum value, positive minimum value, negative minimum value, positive peak value, and negative peak value.
- Press MEM to exit to the recorded measurement values.
- Press PEAK key to output the recorded memory via RS-232C. Refer to section 6.2 regarding RS232C communication.

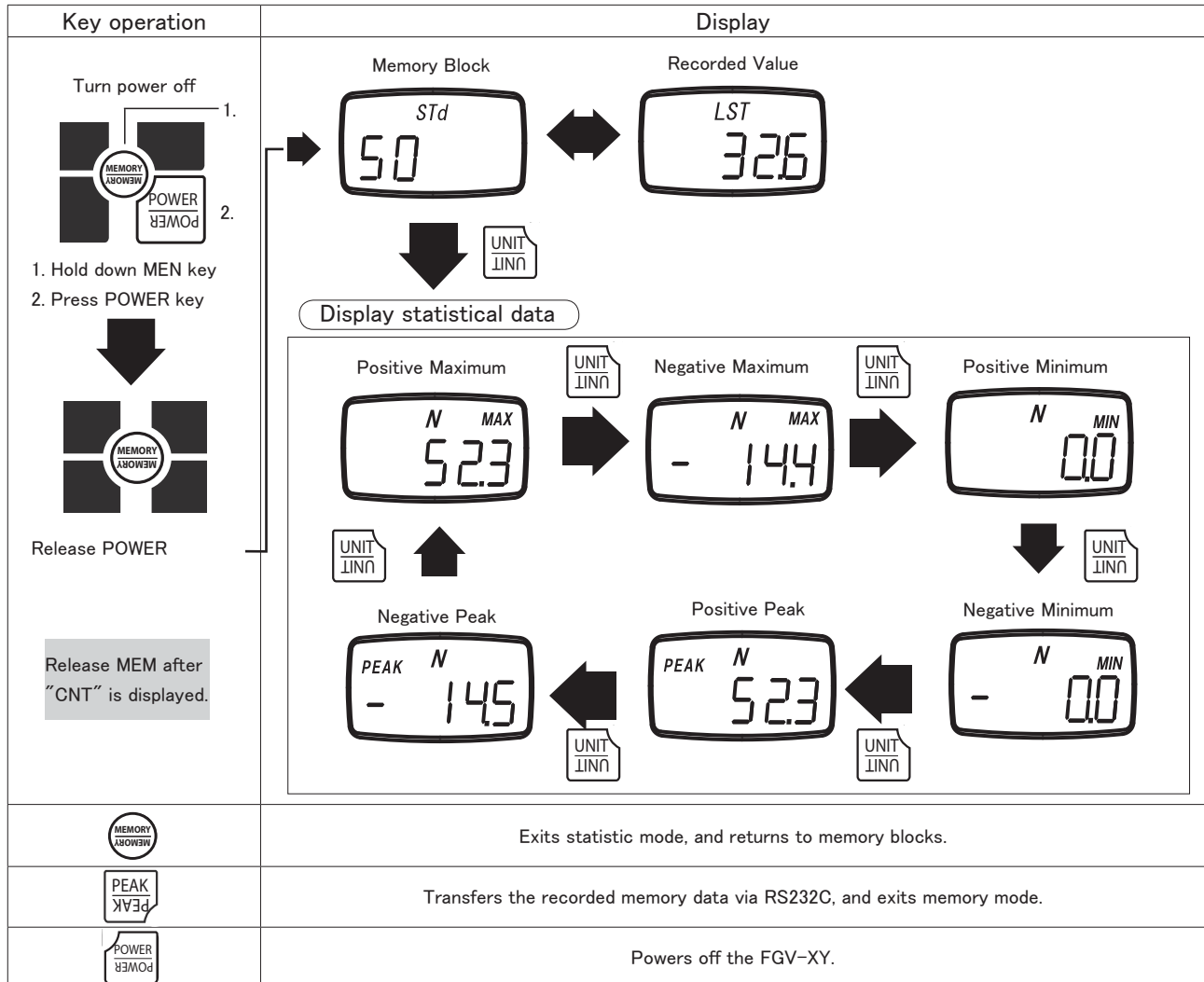

## 5.8 Clearing the Memory

### 5.8.1 Clearing the Last Record

- The last recorded memory block may be erased by pressing ZERO while viewing the last data point.
- If ZERO is pressed while viewing any other data point, the display will show "Err", and will not delete anything.

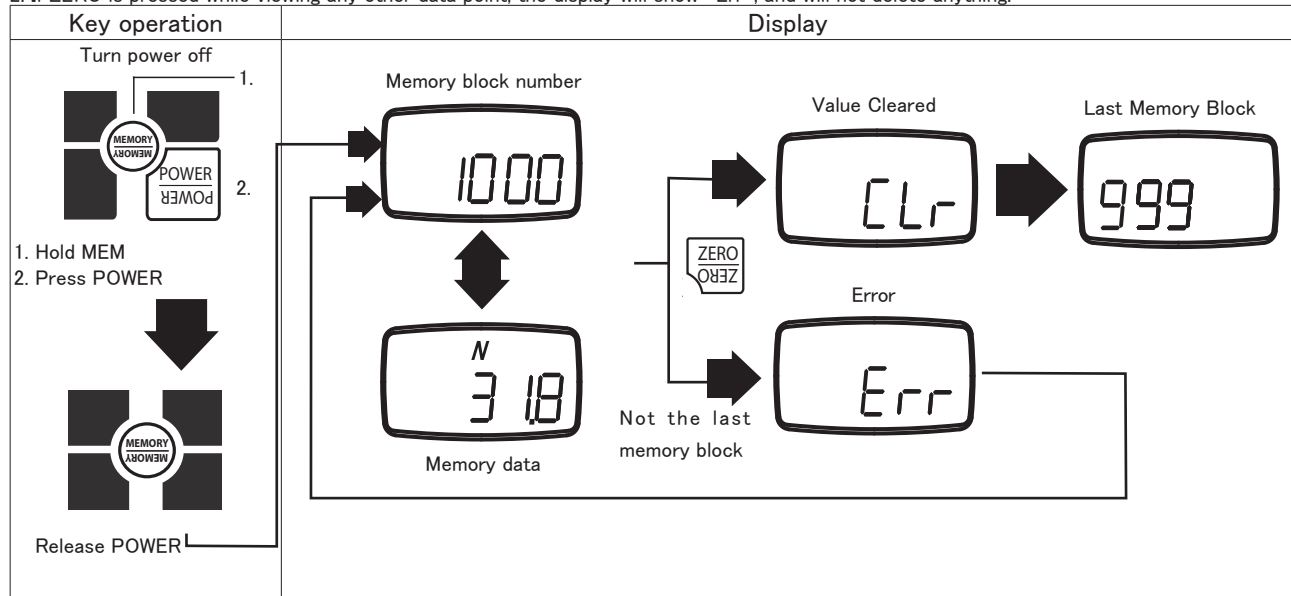



## 5.8.2 Clearing All Memory

1. While viewing the last memory point, press and hold ZERO.
2. The display will show "nonE".
3. All memory has now been cleared, which returns the unit to standard measurement mode.

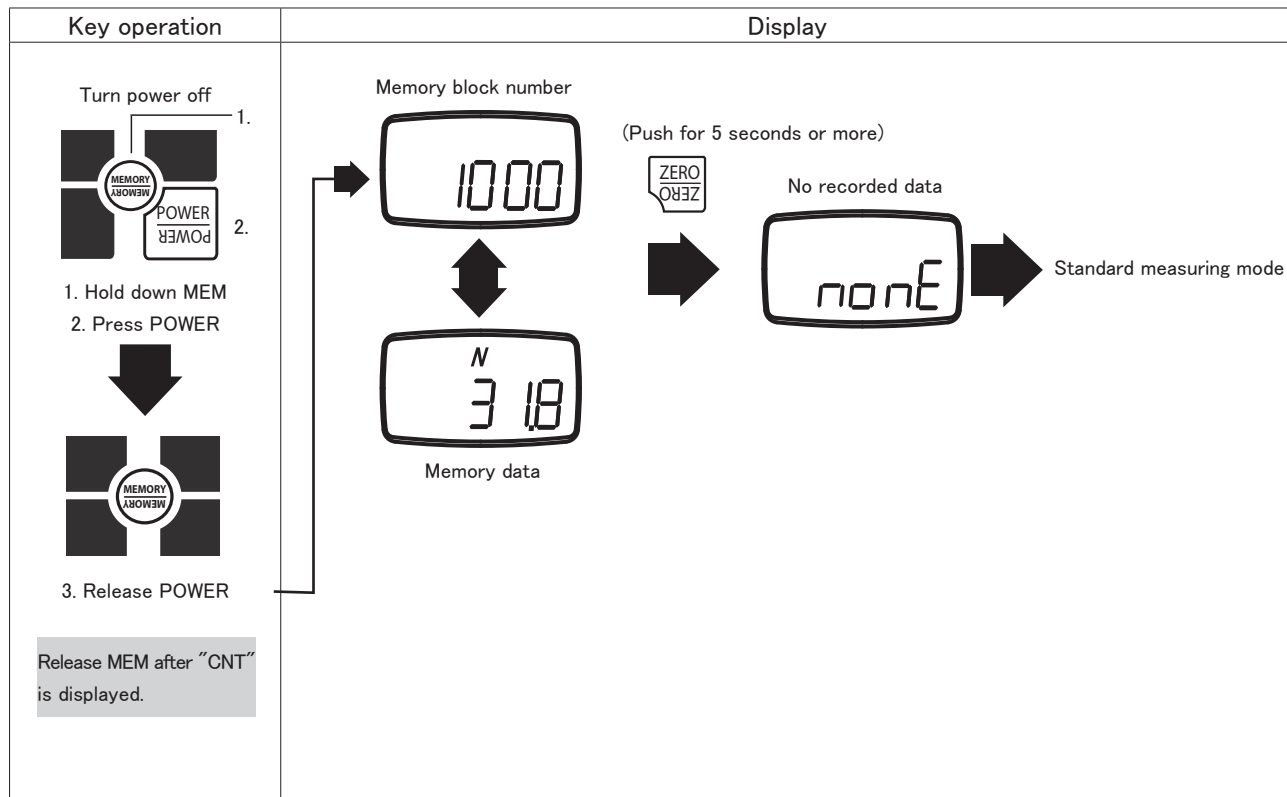

## 5.8.3 No Recorded Data

The display will show "nonE" if switching to memory mode when there are no recorded memory points.



## 5.9 USB Communication

The USB port allows you to connect your FGV-XY via the supplied USB cable to your PC. Our free software, ToriemonUSB, allows you to capture data directly into Excel\*.

### 5.9.1 Features of ToriemonUSB

ToriemonUSB allows you to capture measurement and memory data directly into Microsoft Excel.

\*Microsoft Excel is a registered trademark of Microsoft Corp.

### 5.9.2 Download ToriemonUSB

ToriemonUSB is available for free at the following web address: <http://www.shimpoint.com/software.php>

The manual is included with the software download, and is available separately.

### 5.9.3 Battery Life and USB

Leaving the USB cable connected to the FGV-XY will drain the battery power at a faster rate. Only connect the gauge when taking data, or use the AC adapter for power when accessing data frequently.

## 6. External Data Port

### 6.1 Pin Assignment

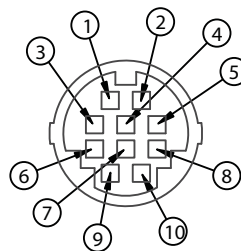
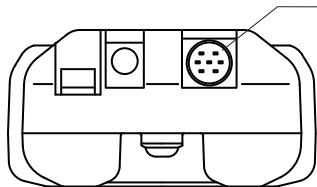

HR12-10RC-10SDL, by Hirose, is the output connector. We recommend HR12-10PCAE300 with 10 conductor shielded cable to make your own.

Please call your Shimpo dealer for information regarding optional cables and accessories.

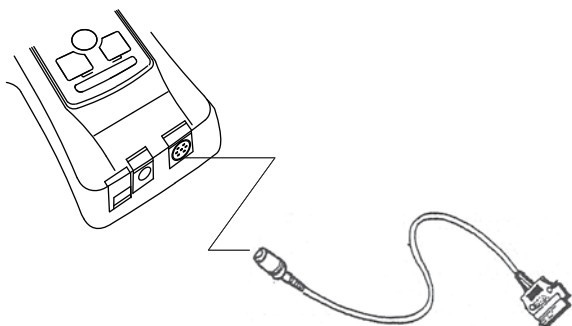

RS232C Output Cable  
(Optional)

Pin Number	Signal Name
1	Analog +
2	Analog GND
3	RxD (RS-232C Received Data) Host --> FGV
4	Digital GND
5	Connection Detection
6	TxD (RS-232C Transmitted Data) FGV --> Host
7	Not Used*
8	Compression Overload / LO Comparator Output
9	Tension overload / HI Comparator Output
10	Common (for Pins 8 and 9)

\*Always leave pin 7 unconnected.

## 6.2. RS-232C Output

The RS-232C data connection allows control from external devices and data transfers.

### 6.2.1 RS-232C Interface

Baud rate*	2400, 4800, 9600, 19200 bps
Length of data bit	8 bit
Parity bit	None
Length of stop bit	1 bit
Flow control	None

\*The baud rate is selectable through setting (f04). See section 4.5.4 for more information.

Default factory setting is 2400 bps. Consult your equipment's manual or manufacturer for the correct baud rate.

ASCII code, alpha numerics and carriage returns are used for RS-232C data transfer.

## 6.2.2 RS232C Communication Commands

Typical Host → FGV commands.

“cr” means carriage return.

Commands	Content	Response	Explanation of Response
AA cr	Tare	AA cr	Tare
AB cr	Cancel data transmission	AB cr	Cancel data transmission
AC cr	Switch to positive peak mode	AC cr	Switch to positive peak mode
AD cr	Switch to standard measuring mode	AD cr	Switch to standard measuring mode
AL cr	Switch to negative peak mode	AL cr	Switch to negative peak mode
AE cr	Clear peak values	AE cr	Clear peak values
AF cr	Switch unit to Kg, g	AF cr	Switch unit to Kg, g
AG cr	Switch unit to N	AG cr	Switch unit to N
AH cr	Switch unit to lb	AH cr	Switch unit to lb
AK cr	Switch unit to oz	AK cr	Switch unit to oz
BA cr	Request current measurement	BA cr NA xxxxxx cr	xxxxxx: Polarity, decimal point, 4 digit value
BB cr	Request continuous transmission of measurement data (10 times/second)	BB cr NA xxxxxx cr	
BB1 cr	Request continuous transmission of measurement data (20 times/second)	BB1 cr NA xxxxxx cr	
BB2 cr	Request continuous transmission of measurement data (50 times/second)	BB2 cr NA xxxxxx cr	
BB3 cr	Request continuous transmission of measurement data (100 times/second)	BB3 cr NA xxxxxx cr	
BC cr	Transmission request of model	BC cr NE xx cr	xx: 2-digit number indicating model 02: FGV-0.5, 03: FGV-1, 04: FGV-2, 05: FGV-5, 06: FGV-10, 07: FGV-20, 08: FGV-50, 09: FGV-100, 1A: FGV-200
BD cr	Transmission request of unit	BD cr NH x cr	x: one-digit number indicating unit 0: N, 1: kg, 2: g, 3: lb, 4: oz
BE cr	Transmission request of plus peak value	BE cr NB xxxxxx cr	xxxxxx: Polarity, decimal point, 4 digit value
BF cr	Transmission request of minus peak value	BF cr NC xxxxxx cr	
If the FGV-XY detects a communication error, the following error codes are sent.		OB cr	Format error (Command error)
		OF cr	Flaming error
		OH cr	Overrun error

## 6.2.3 Connection between FGV and Host

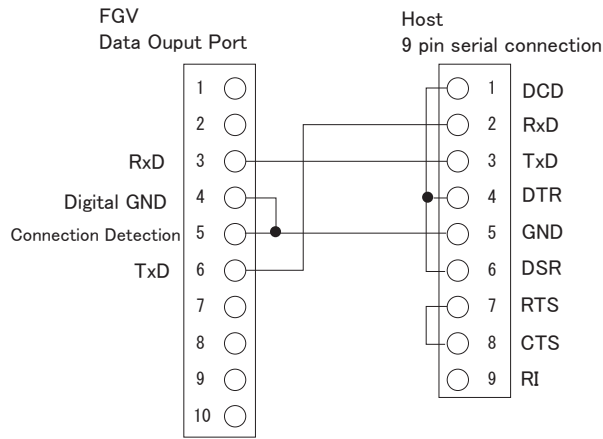

**!** Without the connection between the Digital GND and pin 5, RS-232C communication will not work.

## 6.3 Analog Output

### ± 1V Analog Output

The output voltage's polarity corresponds to the polarity shown on the display during standard measurement mode. The voltage will adjust to any tare command performed.

Output signal	± 1V
Signal method	12 bit D/A converter
Output update	1000 times/second*
Load resistance	>10 k Ω
Output accuracy	± 50mV

The analog output has a default update rate of 1000 times/second. The output voltage is linearly scaled so that the current zero point of the gauge corresponds with 0V, and so that 1V corresponds with 100% of the gauge's rated capacity. This means that the tare function, or any change in the gauge's zero point, will change the maximum voltage shown before the gauge is overloaded.

\*This rate is determined by setting f05. Please refer to 4.5.5.

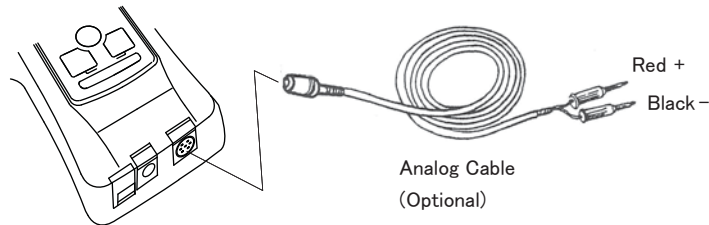

## 6.4 Overload/Comparator Output

Output overload/comparator signal.

Switch of output overload/comparator signal is set by external output setting (f06) of function mode.

### I/F Circuit

Compression Overload /  
LO Comparator Trigger

Tension Overload /  
HI Comparator Trigger

Common  
(For Pins 8 and 9)

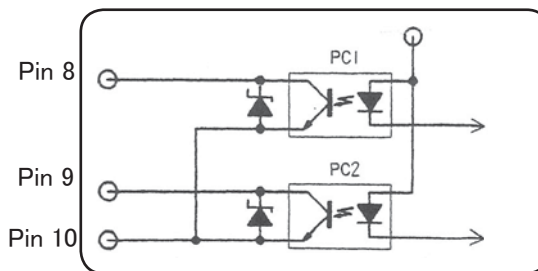

**!** 30V / 5mA Maximum

### Overload Output

When the overload condition is triggered, the corresponding overload output turns on. This can be used to stop a motorized test stand, or an alarm to prevent damage from accidental overload.

When compression overload occurs photo-couple 1(PC1) turns on, and allows current to flow between Pin 8 and 10.

When tension overload occurs photo-couple 2(PC2) turns on, and allows current to flow between Pin 9 and 10.

If no overload condition exists, PC1 and PC2 should be closed, and will not allow current flow.

Overload occurs at about 120% of the gauge's rated capacity. This includes any weight zeroed during any tare operation.

### Comparator Output

When the LO limit is reached, photo-couple 1(PC1) turns on, and allows current to flow between pins 8 and 10.

When the HI limit is reached, photo-couple 2(PC2) turns on, and allows current to flow between pins 9 and 10.

Refer to section 5.5 for information regarding the activation and setting of comparator limits.

## 7. Frequently Asked Questions

### 7.1 Troubleshooting

Questions	Cause	Presumable reason	Procedure
At power on, "OVR" is displayed without any load.	·Load cell damage	The damage may have occurred from a drop, dynamic load, or extreme overload.	Contact your Shimpo dealer for repair information.
"LO BAT" is still displayed after 16 hours of charging.	·Low battery voltage ·Charging circuit malfunction ·AC adapter malfunction	·Battery will no longer charge ·AC Adapter / PCB damaged from misuse	Contact your Shimpo dealer for repair information.
Unit will not power up under battery power.	·Low battery voltage ·Charging circuit malfunction ·AC adapter malfunction	·Battery will no longer charge ·AC Adapter / PCB damaged from misuse	Contact your Shimpo dealer for repair information.
While connected to the AC adapter, "BAT" is not displayed.	·Charging circuit malfunction ·AC adapter malfunction	·AC Adapter / PCB damaged from misuse	Contact your Shimpo dealer for repair information.
When measuring small forces, the display zeros itself.	·Tracking Function Section 4.4	Tracking is on, and zeros the small forces because it looks like a temperature change.	Turn off Tracking. Section 4.4
The measurement value changes with the orientation of the gauge.	Weight of the sensor shaft.	The gauge is measuring the small weight of the sensor shaft which is connected to the load cell.	Press ZERO after the gauge is in position to negate any discrepancies due to the sensor shaft's weight.
The software, Toriemon, doesn't work with my FGV-XY.	·Toriemon isn't compatible with the FGV-XY.	·Toriemon is only compatible with DART and JAVELIN series gauges.	·Download ToriemonUSB from the following website.

### 7.2 Technical Inquiries

Questions	Explanation	Reference
How long should my FGV-XY's battery last?	The nickel metal hydride battery should last for 500 full charge cycles, and should optimally last 8 hours on a full charge.	Please charge battery after discharging electricity until "LO BAT" is displayed at LCD.
What is the reason for different capacity gauges?	To obtain the best accuracy in each situation, different capacities are available.	To achieve the best accuracy, choose a gauge that will allow most of your measurements to fall within 50 – 100% of the gauge's rated capacity.
Why does measuring data show variations?	Although there are many reasons, the measuring value is affected by vibration if you hold by hands.	Fluctuation will be reduced when using stand.
How does side loading and torque affect the gauge's readings?	Side loading and torque effects are not measurable, can damage the internal components, and will void your warranty.	
How are the force gauges calibrated?	The FGV-XY is calibrated using dead weights at the factory.	Contact your Shimpo dealer for information regarding NIST certification for your gauge.
Is the battery user servicable?	The internal battery is not user servicable.	Please contact your Shimpo dealer regarding battery replacement, and repair.
Do you have CAD or technical drawings available?	CAD and technical drawings are available for the FGV-XY.	Please contact your Shimpo dealer for information regarding CAD and technical drawings.
Is the FGV-XY case waterproof?	No, the case is not waterproof or water resistant. Do not use in or around water or high levels of humidity or condensation.	

## 8. Support

### 8.1 Repair and Calibration

Please contact your Shimpo dealer for information regarding the repair and calibration of your FGV-XY.

### 8.2 Warranty

Nidec-Shimpo Corp. warrants, to the original purchaser of new products only, that this product shall be free from defects in workmanship and materials under normal use and proper maintenance for one year from the date of original purchase. See final page for full warranty disclosure.

## 9. Specifications and Dimensions

Model	FGV-0.5XY	FGV-1XY	FGV-2XY	FGV-5XY	FGV-10XY	FGV-20XY	FGV-50XY	FGV-100XY	FGV-200XY
Capacity	0.500lb	1.000lb	2.000lb	20.00 N	50.00 N	100.0 N	200.0 N	500.0 N	1000 N
	2.000 N	5.000 N	10.00 N	2.000 kg	5.000 kg	10.00 kg	20.00 kg	50.00 kg	100.0 kg
	200.0 g	500.0 g	1000 g	2.000 kg	5.000 kg	10.00 kg	20.00 kg	50.00 kg	100.0 kg
	8oz	16oz	2 lb	5 lb	10 lb	20 lb	50 lb	100 lb	200 lb
Resolution	0.001lb		0.001lb	0.01 N	0.01 N	0.1 N		0.1 N	1 N
	0.001 N		0.01 N	0.001 kg	0.001 kg	0.01 kg		0.01 kg	0.1 kg
	0.1 kg		1 kg	0.001 lb	0.01 lb	0.01 lb		0.1 lb	0.1 lb
	0.01 oz		0.001 lb	0.001 lb	0.01 lb	0.01 lb		0.1 lb	0.1 lb
Units of Measure	lb / oz / g / N			lb / kg / N					
Measurement Modes	Standard, Compression Peak, Tension Peak								
Display Rate	User Selectable: 1, 2, 3, 5, 10, 20 times per second								
Sampling Rate	1000 times per second								
Accuracy	± 0.2% F.S.								
Influence of temperature	Gain : ± 0.01 LOAD / Zero : ±0.01 / R.C. / Drift of zero point can be cancelled with tracking function.								
Display	Main display: 4-digits 12mm high, Reversible								
	Units display: 3-digits 7mm high								
	Other display: "LO BAT"(Low Battery Voltage), "BAT"(Battery Charging), "OVR"(Overload), "Peak"(Peak Hold)								
Overload	200% of Full Scale								150% F.S.
Tracking	User Selectable (ON/OFF)								
Output	USB	Allows communication between FGV-XY and ToriemonUSB via USB cable(included).							
	RS-232C	Allows communication between the FGV-XY and RS-232C devices. RS-232C cable is an optional accessory.							
	Analog	± 1V, Accuracy is ± 50mV through a 12 bit D/A. ZERO affects this output, and is updated at 1000 times/second. Load is >10k Ω							
	Overload/Comparator	Open-collector output (Max DC30V/5mA).							
Power	Rechargeable Nickel hydride battery or AC adapter/charger. Usable while charging. Operating Time: Approximately 8 hours after a full charge. Charging Time: 16 Hours Max.								
Auto Power Off	Default is 10 minutes. Can be disabled. Automatically disabled when connected to AC adapter.								
Memory function	Continuous memory: 1000 data points, Single memory: 100 data points, Standard memory: 50 data points Statistics functions (max, minimum, peak, average, standard deviation)								
Comparator function	User Selectable: HI and LO								
Temperature range	0 ~ 40° C (-32 ~ 104° F)								
Humidity range	35 ~ 85% RH								
Dimensions	147mm ※ (L)x 75mm (W) x 38mm(H)								
Weight	Approx. 450g								Approx. 500g
Accessories (Included)	AC adapter/charger, carrying case, hook, chisel, flat head, notched head, hanger, cone head, thread Adapter, extension rod, USB cable								
Application software	Application software (USB version): Available at <a href="http://www.shimpoinst.com/software">www.shimpoinst.com/software</a> for free.								

※ Dimension for FGP-0.2 ~ 0.5 is 141mm, FGP-100 is 149mm.

# Dimensions

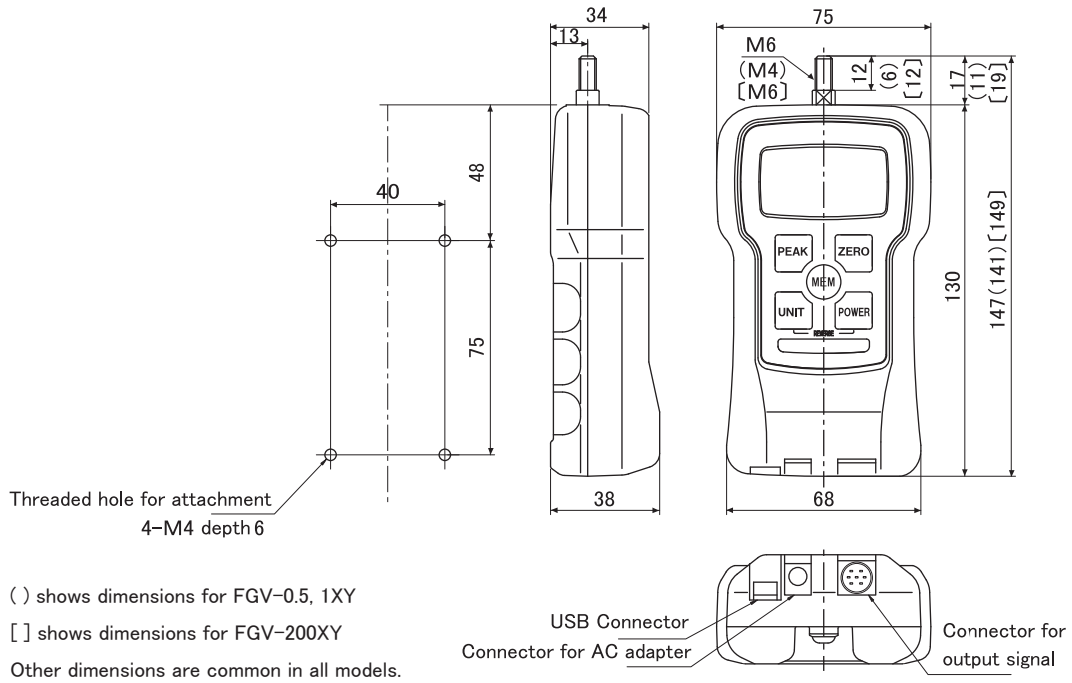

## Measurement Attachments (standard accessories)

The following drawing is for the attachments included with the FGV-5 ~ 50XY (M6).  
Please contact your Shimpo dealer for information on the attachments included with 0.5, 1, 2, and 200 models.

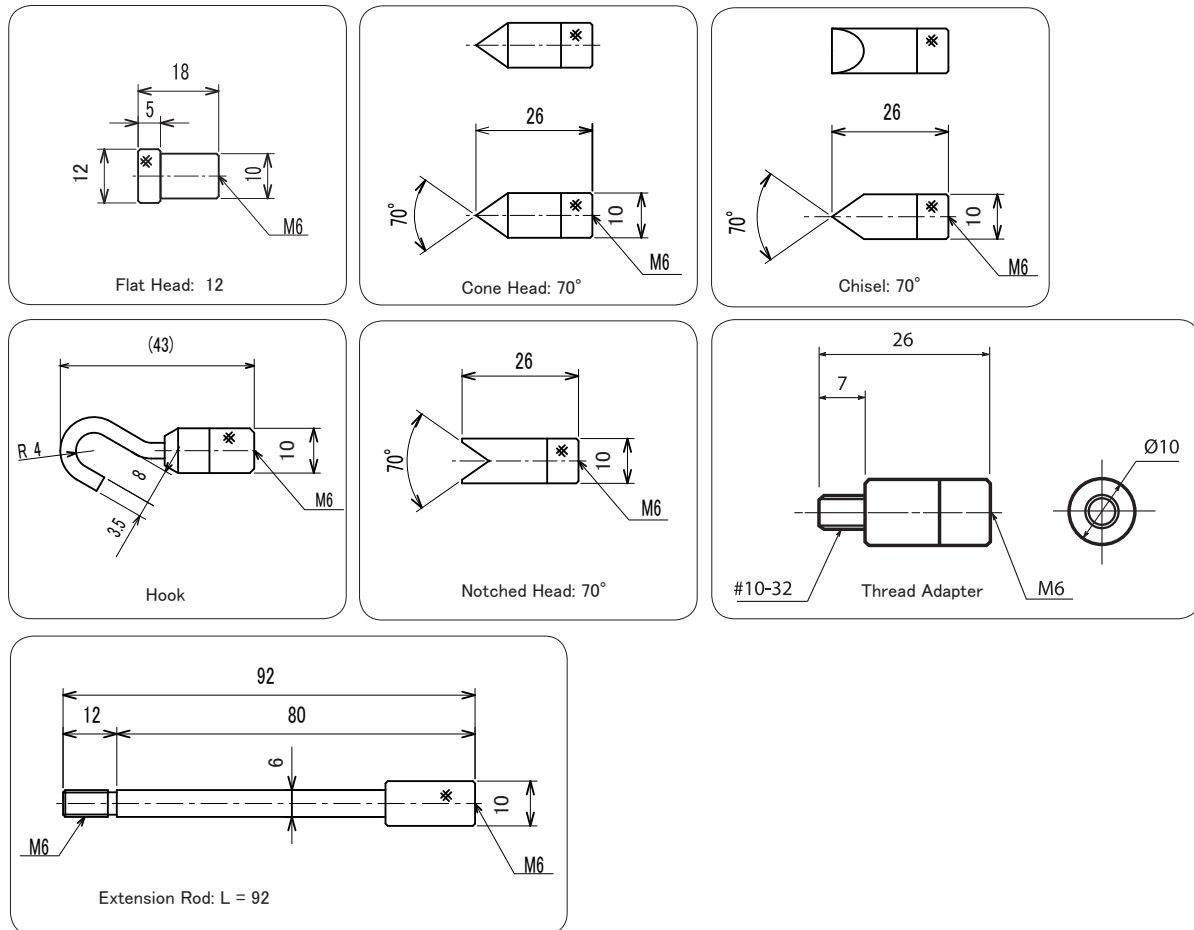



**LIMITED EXPRESS WARRANTY**  
 Shimpo Instruments warrants, to the original purchaser of new products only, that this product shall be free from defects in workmanship and materials under normal use and proper maintenance for one year from the date of original purchase. This warranty shall not be effective if the product has been subject to overload, misuse, negligence, or accident, or if the product has been repaired or altered outside of Shimpo Instrument's authorized control in any respect which in Shimpo Instruments' judgment, adversely affects its condition or operation.

**DISCLAIMER OF ALL OTHER WARRANTIES**  
 The foregoing warranty constitutes the SOLE AND EXCLUSIVE WARRANTY, and Shimpo Instruments hereby disclaims all other warranties, expressed, statutory or implied, applicable to the product, including, but not limited to all implied warranties of merchantability and fitness.

**LIMITATION OF REMEDY**  
 Under this warranty, Shimpo Instruments' SOLE OBLIGATION SHALL BE TO REPAIR OR REPLACE the defective product or part, at Shimpo Instrument's option.

Shimpo Instruments reserves the right to satisfy warranty obligation in full by reimbursing Buyer for all payments made to Shimpo Instruments, whereupon, title shall pass to Shimpo Instruments upon acceptance of return goods. To obtain warranty service, Purchaser must obtain Shimpo Instruments' authorization before returning the product, properly repackaged, freight pre-paid to Shimpo Instruments.

**INDEMNIFICATION & LIMITATION OF DAMAGES**  
 Buyer agrees to indemnify and hold Shimpo Instruments harmless from and against all claims and damages imposed upon or incurred arising, directly or indirectly, from Buyer's failure to perform or satisfy any of the terms described herein. In no event shall Shimpo Instruments be liable for injuries of any nature involving the product, including incidental or consequential damages to person or property, any economic loss or loss of use.

**MERGER CLAUSE**  
 Any statements made by the Sellers' representative do not constitute warranties except to the extent that they also appear in writing. This writing constitutes the entire and final expression of the parties' agreement.