

Features

- 32.768 kHz ± 5 , ± 10 , ± 20 ppm frequency stability options over temp
- World's smallest TCXO in a 1.5 x 0.8 mm CSP
- Operating temperature ranges:
 - 0°C to +70°C
 - -40°C to +85°C
- Ultra-low power: <1 μ A
- Vdd supply range: 1.5V to 3.63V
- Improved stability reduces system power with fewer network timekeeping updates
- NanoDrive™ programmable output swing for lowest power and direct XTAL SoC input interface
- Internal filtering eliminates external Vdd bypass cap and saves space
- Pb-free, RoHS and REACH compliant

Applications

- Smart Meters (AMR)
- Health and Wellness Monitors
- Pulse-per-Second (pps) Timekeeping
- RTC Reference Clock



INSTANT
SAMPLES



GREEN
SOLUTIONS



LIFETIME
WARRANTY



Electrical Characteristics

Parameter	Symbol	Min.	Typ.	Max.	Unit	Condition
Frequency and Stability						
Output Frequency	F _{out}	32.768			kHz	
Frequency Stability Over Temperature ^[1] (without Initial Offset ^[2])	F _{stab}	-5.0		5.0	ppm	Stability part number code = E
		-10		10		Stability part number code = F
		-20		20		Stability part number code = 1
Frequency Stability Over Temperature (with Initial Offset ^[2])	F _{stab}	-10		10	ppm	Stability part number code = E
		-13		13		Stability part number code = F
		-22		22		Stability part number code = 1
Frequency Stability vs Voltage	F _{vdd}	-0.75		0.75	ppm	1.8V \pm 10%
		-1.5		1.5	ppm	1.5V – 3.63V
First Year Frequency Aging	F _{aging}	-1.0		1.0	ppm	T _A = 25°C, Vdd = 3.3V
Jitter Performance (T_A = over temp)						
Long Term Jitter				2.5	μ s _{pp}	81920 cycles (2.5 sec), 100 samples
Period Jitter			35		ns _{RMS}	Cycles = 10,000, T _A = 25°C, Vdd = 1.5V – 3.63V
Supply Voltage and Current Consumption						
Operating Supply Voltage	Vdd	1.5		3.63	V	T _A = -40°C to +85°C
Core Supply Current ^[3]	I _{dd}		0.99		μ A	T _A = 25°C, Vdd = 1.8V, LVCMOS Output configuration, No Load
				1.52		T _A = -40°C to +85°C, Vdd = 1.5V – 3.63V, No Load
Power-Supply Ramp	t _{Vdd_Ramp}			100	ms	Vdd Ramp-Up 0 to 90% Vdd, T _A = -40°C to +85°C
Start-up Time at Power-up	t _{start}		180	300	ms	T _A = -40°C +60°C, valid output
				350		T _A = +60°C to +70°C, valid output
				380		T _A = +70°C to +85°C, valid output

Notes:

1. No board level underfill. Measured as peak-to-peak/2. Inclusive of 3x-reflow and $\pm 20\%$ load variation. Tested with Agilent 53132A frequency counter. Due to the low operating frequency, the gate time must be ≥ 100 ms to ensure an accurate frequency measurement.
2. Initial offset is defined as the frequency deviation from the ideal 32.768 kHz at room temperature, post reflow.
3. Core operating current does not include output driver operating current or load current. To derive total operating current (no load), add core operating current + output driver operating current, which is a function of the output voltage swing. See the description titled, **Calculating Load Current**.

Electrical Characteristics (continued)

Parameter	Symbol	Min.	Typ.	Max.	Unit	Condition
Operating Temperature Range						
Commercial Temperature	Op_Temp	0		70	°C	
Industrial Temperature		-40		85	°C	
LVC MOS Output						
Output Rise/Fall Time	tr, tf		100	200	ns	10-90% (Vdd), 15 pF Load
				50		10-90% (Vdd), 5 pF Load, Vdd ≥ 1.62V
Output Clock Duty Cycle	DC	48		52	%	
Output Voltage High	VOH	90%			V	Vdd: 1.5V – 3.63V. I _{OH} = -1 μA, 15 pF Load
Output Voltage Low	VOL			10%	V	Vdd: 1.5V – 3.63V. I _{OL} = 1 μA, 15 pF Load
NanoDrive™ Reduced Swing Output						
Output Rise/Fall Time	tf, tf			200	ns	30-70% (V _{OL} /V _{OH}), 10 pF Load
Output Clock Duty Cycle	DC	48		52	%	
AC-coupled Programmable Output Swing	V _{sw}		0.20 to 0.80		V	ANY1552 does not internally AC-couple. This output description is intended for a receiver that is AC-coupled. Vdd: 1.5V – 3.63V, 10 pF Load, I _{OH} / I _{OL} = ±0.2 μA
DC-Biased Programmable Output Voltage High Range	VOH		0.6 to 1.225		V	Vdd: 1.5V – 3.63V. I _{OH} = -0.2 μA, 10 pF Load
DC-Biased Programmable Output Voltage Low Range	VOL		0.35 to 0.80		V	Vdd: 1.5V – 3.63V. I _{OL} = 0.2 μA, 10 pF Load
Programmable Output Voltage Swing Tolerance		-0.055		0.055	V	T _A = -40°C to +85°C, Vdd = 1.5V to 3.63V.

Pin Configuration

CSP Pin	Symbol	I/O	Functionality
1, 4	GND	Power Supply Ground	Connect to ground. All GND pins must be connected to power supply ground. The GND pins can be connected together, as long as both GND pins are connected ground.
2	CLK Out	OUT	Oscillator clock output. When interfacing to an MCU's XTAL, the CLK Out is typically connected to the receiving IC's X IN pin. The ANY1552 oscillator output includes an internal driver. As a result, the output swing and operation is not dependent on capacitive loading. This makes the output much more flexible, layout independent, and robust under changing environmental and manufacturing conditions.
3	Vdd	Power Supply	Connect to power supply 1.5V ≤ Vdd ≤ 3.63V. Under normal operating conditions, Vdd does not require external bypass/decoupling capacitor(s). For more information about the internal power-supply filtering, see <i>Power-Supply Noise Immunity</i> section in the detailed description.. Contact factory for applications that require a wider operating supply voltage range.

CSP Package (Top View)

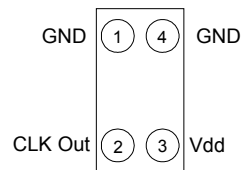

System Block Diagram

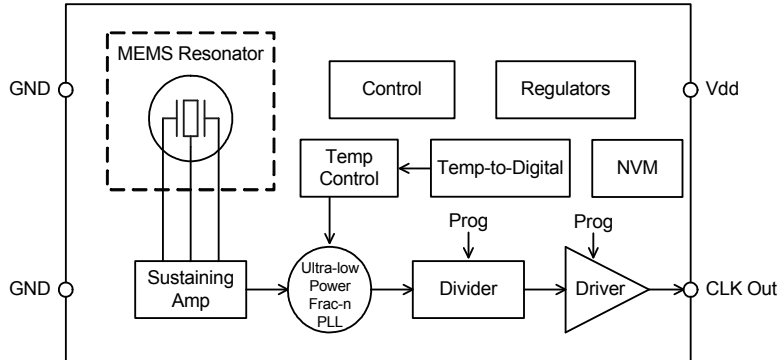

Figure 1.

Absolute Maximum

Attempted operation outside the absolute maximum ratings cause permanent damage to the part. Actual performance of the IC is only guaranteed within the operational specifications, not at absolute maximum ratings.

Parameter	Test Condition	Value	Unit
Continuous Power Supply Voltage Range (Vdd)		-0.5 to 3.63	V
Short Duration Maximum Power Supply Voltage (Vdd)	≤30 minutes	4.0	V
Continuous Maximum Operating Temperature Range	Vdd = 1.5V - 3.63V	105	°C
Short Duration Maximum Operating Temperature Range	Vdd = 1.5V - 3.63V, ≤30 mins	125	°C
Human Body Model (HBM) ESD Protection	JESD22-A114	3000	V
Charge-Device Model (CDM) ESD Protection	JESD22-A115	750	V
Machine Model (MM) ESD Protection	JESD22-C101	300	V
Latch-up Tolerance	JESD78 Compliant		
Mechanical Shock Resistance	Mil 883, Method 2002	10,000	g
Mechanical Vibration Resistance	Mil 883, Method 2007	70	g
1508 CSP Junction Temperature		150	°C
Storage Temperature		-65°C to 150°C	

Description

The ANY1552 is an ultra-small and ultra-low power 32.768 kHz TCXO optimized for battery-powered applications. Anyclk's silicon MEMS technology enables the first 32 kHz TCXO in the world's smallest footprint and chip-scale packaging (CSP). Typical core supply current is only 1 μ A. And unlike standard oscillators, the ANY1552 features NanoDrive™, a factory programmable output that reduces the voltage swing to minimize power.

Anyclk's MEMS oscillators consist of MEMS resonators and a programmable analog circuit. Our MEMS resonators are built with Anyclk's unique MEMS First™ process. A key manufacturing step is EpiSeal™ during which the MEMS resonator is annealed with temperatures over 1000°C. EpiSeal creates an extremely strong, clean, vacuum chamber that encapsulates the MEMS resonator and ensures the best performance and reliability. During EpiSeal, a poly silicon cap is grown on top of the resonator cavity, which eliminates the need for additional cap wafers or other exotic packaging. As a result, Anyclk's MEMS resonator die can be used like any other semiconductor die. One unique result of Anyclk's MEMS First and EpiSeal manufacturing processes is the capability to integrate Anyclk's MEMS die with a SOC, ASIC, microprocessor or analog die within a package to eliminate external timing components and provide a highly integrated, smaller, cheaper solution to the customer.

TCXO Frequency Stability

The ANY1552 is factory calibrated (trimmed) over multiple temperature points to guarantee extremely tight stability over temperature. Unlike quartz crystals that have a classic tuning fork parabola temperature curve with a 25°C turnover point with a 0.04 ppm/C² temperature coefficient, the ANY1552 temperature coefficient is calibrated and corrected over temperature with an active temperature correction circuit. The result is 32 kHz TCXO with extremely tight frequency variation over the -40°C to +85°C temperature range. Contact Anyclk for applications that require a wider supply voltage range >3.63V, or lower operating frequency below 32 kHz.

When measuring the ANY1552 output frequency with a frequency counter, it is important to make sure the counter's gate time is ≥ 100 ms. The slow frequency of a 32kHz clock will give false readings with faster gate times.

Power Supply Noise Immunity

In addition to eliminating external output load capacitors common with standard XTALs, this device includes special power supply filtering and thus, eliminates the need for an external Vdd bypass-decoupling capacitor to keep the footprint as small as possible. Internal power supply filtering is designed to reject more than ± 150 mV noise and frequency components from low frequency to more than 10 MHz.

Start-up and Steady-State Supply Current

The ANY1552 TCXO starts-up to a valid output frequency within 300 ms (180 ms typ). To ensure the device starts-up within the specified limit, make sure the power-supply ramps-up in approximately 10 - 20 ms (to within 90% of Vdd).

During initial power-up, the ANY1552 power-cycles internal blocks, as shown in the power-supply start-up and steady state plot in the *Typical Operating Curves* section. Power-up and initialization is typically 200 ms, and during that time, the peak supply current reaches 28 μ A as the internal capacitors are charged, then sequentially drops to its 990 nA steady-state current. During steady-state operation, the internal temperature compensation circuit turns on every 350 ms for a duration of approximately 10 ms.

Output Voltage

The ANY1552 has two output voltage options. One option is a standard LVCMOS output swing. The second option is the NanoDrive reduced swing output. Output swing is customer specific and Factory programmed between 200 mV and 800 mV. For DC-coupled applications, output V_{OH} and V_{OL} are individually factory programmed to the customers' requirement. V_{OH} programming range is between 600 mV and 1.225V in 100 mV increments. Similarly, V_{OL} programming range is between 350 mV and 800 mV. For example; a PMIC or MCU is internally 1.8V logic compatible, and requires a 1.2V V_{IH} and a 0.6V V_{IL} . Simply select ANY1552 NanoDrive factory programming code to be "D14" and the correct output thresholds will match the downstream PMIC or MCU input requirements. Interface logic will vary by manufacturer and we recommend that you review the input voltage requirements for the input interface.

For DC-biased NanoDrive output configuration, the minimum V_{OL} is limited to 350mV and the maximum allowable swing ($V_{OH} - V_{OL}$) is 750mV. For example, 1.1V V_{OH} and 400mV V_{OL} is acceptable, but 1.2V V_{OH} and 400 mV V_{OL} is not acceptable.

When the output is interfacing to an XTAL input that is internally AC-coupled, the ANY1552 output can be Factory programmed to match the input swing requirements. For example, if a PMIC or MCU input is internally AC-coupled and requires an 800mV swing, then simply choose the ANY1552 NanoDrive programming code "AA8" in the part number. It is important to note that the ANY1552 does not include internal AC-coupling capacitors. Please see the *Part Number Ordering* section at the end of the datasheet for more information about the part number ordering scheme.

ANY1552 NanoDrive™

Figure 2 shows a typical output waveform of the ANY1552 (into a 10 pF load) when factory programmed for a 0.70V swing and DC bias (V_{OH}/V_{OL}) for 1.8V logic:

Example:

- NanoDrive part number coding: D14. Example part number: ANY1552AI-JE-D14-32.768
- $V_{OH} = 1.1V$, $V_{OL} = 0.4V$ ($V_{sw} = 0.70V$)

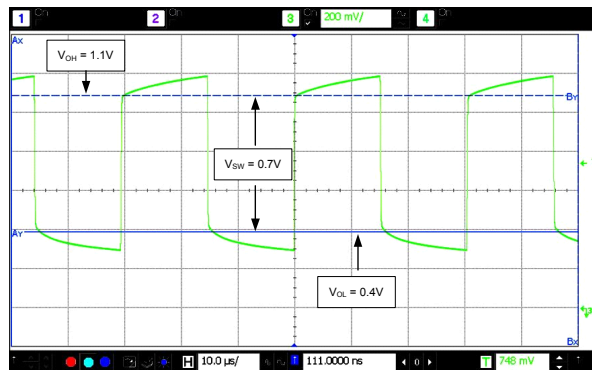

Figure 2. ANY1552AI-JE-D14-32.768 Output Waveform (10 pF Load)

Table 1 shows the supported NanoDrive V_{OH} , V_{OL} factory programming options.

Table 1. Acceptable V_{OH}/V_{OL} NanoDrive Levels

V_{OL}/V_{OH}	1.225	1.100	1.000	0.900	0.800	0.700	0.600
0.800	D28	D18	D08				
0.700	D27	D17	D07	D97			
0.525	D26	D16	D06	D96	D86		
0.500	D25	D15	D05	D95	D85	D75	
0.400		D14	D04	D94	D84	D74	D64
0.350		D13	D03	D93	D83	D73	D63

Table 2 shows the supported AC coupled Swing levels. The “AC-coupled” terminology refers to the programming description for applications where the downstream chipsets includes an internal AC-coupling capacitor, and therefore, only the output swing is important and V_{OH}/V_{OL} is not relevant. For

these applications, refer to Table 2 for the acceptable voltage swing options.

Table 2. Acceptable NanoDrive Voltage Swing Options (for downstream AC-coupled receivers)

Swing	0.800	0.700	0.600	0.500	0.400	0.300	0.250	0.200
Output Code	AA8	AA7	AA6	AA5	AA4	AA3	AA2	AA1

Example:

- NanoDrive part number coding: AA2. Example part number: ANY1552AI-JE-AA2-32.768
- Output voltage swing: 0.250V

The values listed in Tables 1 and -2 are nominal values at 25°C and will exhibit a tolerance of ±55 mV across V_{dd} and -40°C to 85°C operating temperature range.

ANY1552 Full Swing LVCOMS Output

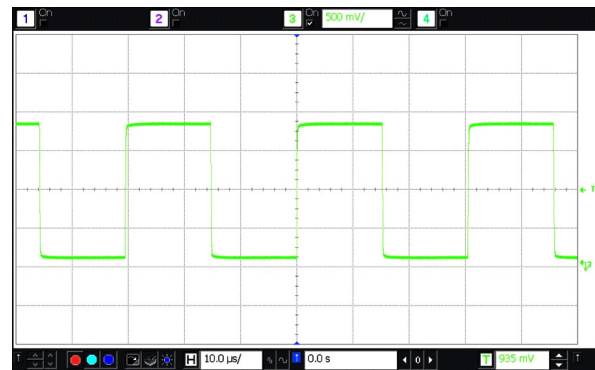

Figure 3. LVCMOS Waveform ($V_{dd} = 1.8V$) into 15 pF Load

Example:

- LVCMOS output part number coding is always **DCC**
- Example part number: ANY1552AI-JE-DCC-32.768

Calculating Load Current

No Load Supply Current

When calculating no-load power for the ANY1552, the core and output driver components need to be added. Since the output voltage swing can be programmed to minimize load current, the output driver current is variable. Therefore, no-load operating supply current is broken into two sections; core and output driver. The equation is as follows:

Total Supply Current (no load) = I_{dd} Core + I_{dd} Output Driver

Example 1: Full-swing LVCMOS

- V_{dd} = 1.8V
- I_{dd} Core = 990nA (typ)
- V_{out_{pp}} = 1.8V
- I_{dd} Output Driver: (C_{driver})(V_{out})(F_{out}) = (3.5pF)(1.8V)(32768Hz) = 206nA

Supply Current = 990nA + 206nA = 1.2μA

Example 2: NanoDrive Reduced Swing

- V_{dd} = 1.8V
- I_{dd} Core = 990nA (typ)
- V_{out_{pp}} (Programmable) = V_{OH} - V_{OL} = 1.1V - 0.6V = 500mV
- I_{dd} Output Driver: (C_{driver})(V_{out})(F_{out}) = (3.5pF)(0.50V)(32768Hz) = 57nA

Supply Current = 990nA + 57nA = 1.05μA

Total Supply Current with Load

To calculate the total supply current, including the load, follow the equation listed below. Note the 30% reduction in power with NanoDrive.

Total Current = I_{dd} Core + I_{dd} Output Driver + Load Current

Example 1: Full-swing LVCMOS

- V_{dd} = 1.8V
- I_{dd} Core = 990nA
- Load Capacitance = 10pF
- I_{dd} Output Driver: (C_{driver})(V_{out})(F_{out}) = (3.5pF)(1.8V)(32768Hz) = 206nA
- Load Current: (10pF)(1.8V)(32768Hz) = 590nA
- Total Current = 990nA + 206nA + 590nA = 1.79μA

Example 2: NanoDrive Reduced Swing

- V_{dd} = 1.8V
- I_{dd} Core = 990nA
- Load Capacitance = 10pF
- V_{out_{pp}} (Programmable): V_{OH} - V_{OL} = 1.1V - 0.6V = 500mV
- I_{dd} Output Driver: (C_{driver})(V_{out})(F_{out}) = (3.5pF)(0.5V)(32768Hz) = 57nA
- Load Current: (10pF)(0.5V)(32768Hz) = 164nA
- Total Current = 990nA + 57nA + 164nA = 1.2μA

Typical Operating Curves

(T_A = 25°C, V_{dd} = 1.8V, unless otherwise stated)

Frequency Stability Over Temperature (Pre-Reflow)

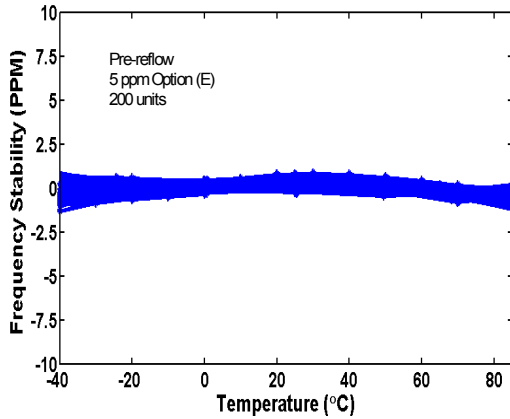

Frequency Stability Over Temperature (Post-Reflow)

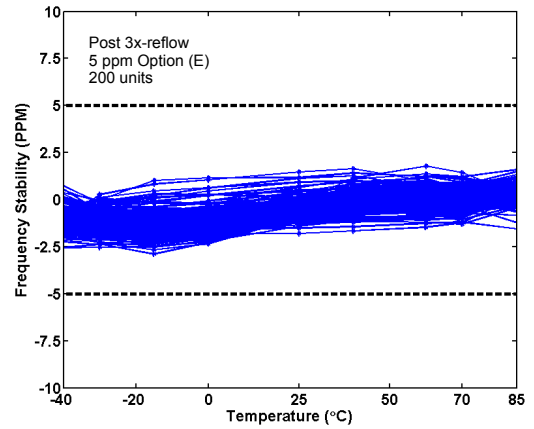

Core Current Over Temperature

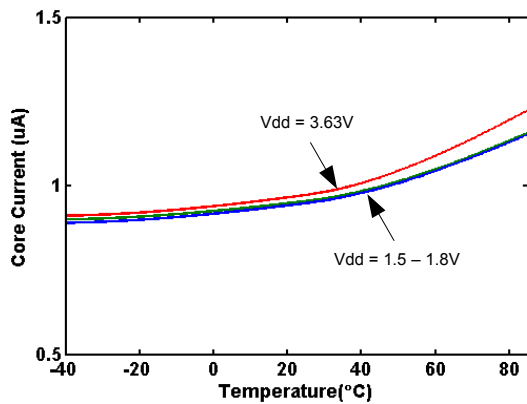

Output Stage Current Over Temperature (NanoDrive Output)

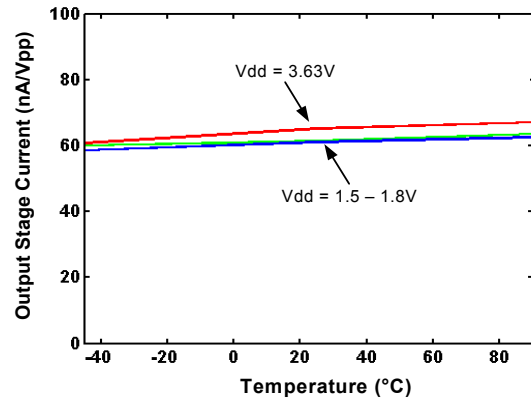

Total Supply Current Over Temperature, LVC MOS (Core + LVC MOS Output Driver, No Load)

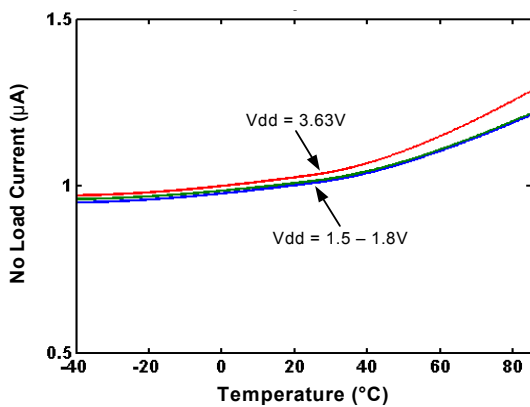

Start-up and Steady-State Current Profile

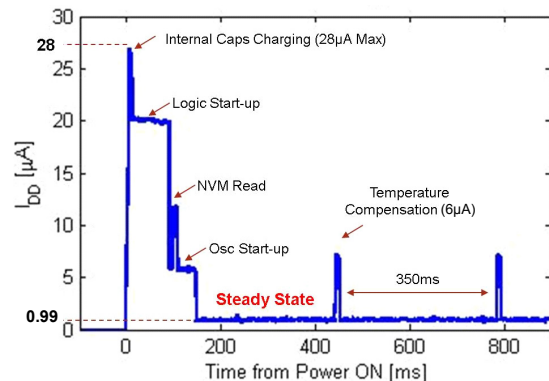

Power Supply Noise Rejection (±150mV Noise)

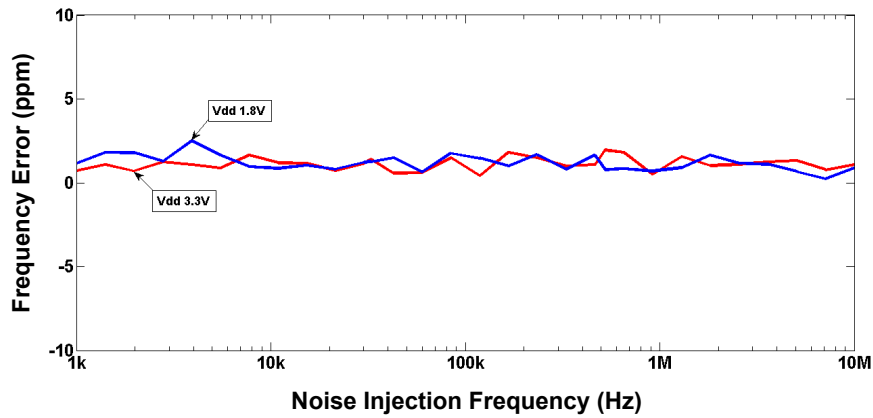

Temperature Ramp Response

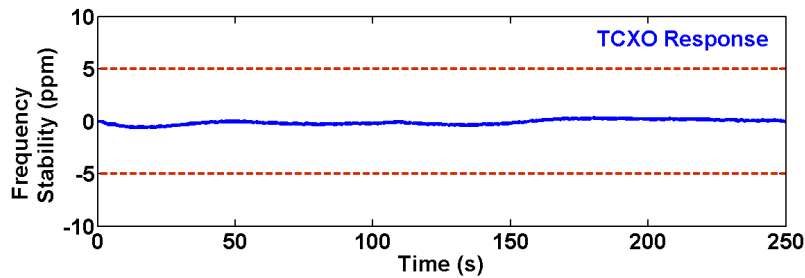
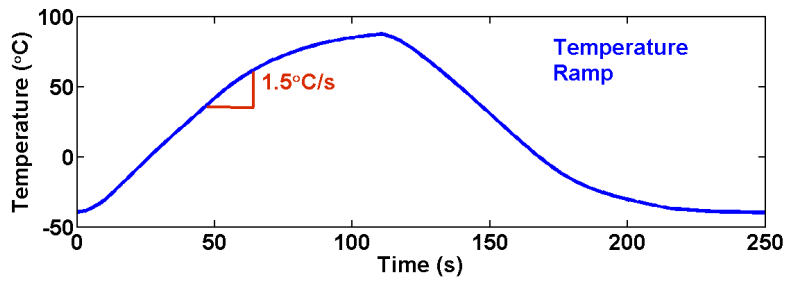

NanoDrive™ Output Waveform

(V_{OH} = 1.2V, V_{OL} = 0.4V, 10 pF Load;
ANY1552AI-JE-D14-32.768)

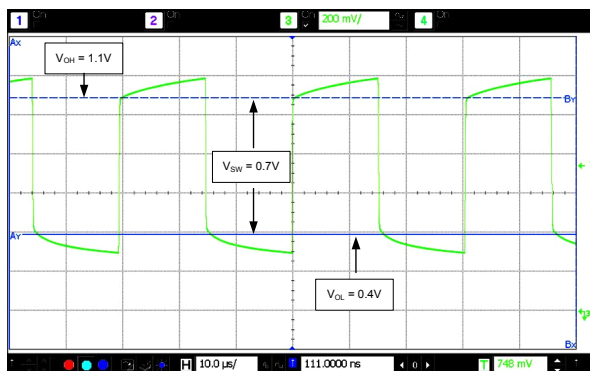

LVC MOS Output Waveform

(V_{swing} = 1.8V, ANY1552AI-JE-DCC-32.768, 10 pF Load)

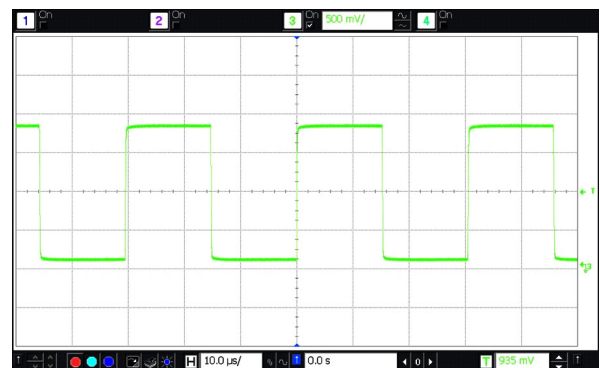

Dimensions and Patterns

Package Size – Dimensions (Unit: mm)	Recommended Land Pattern (Unit: mm)
<p>1.55 x 0.85 mm CSP</p>	<p>(soldermask openings shown with heavy dashed line)</p> <p>Recommend 4-mil (0.1mm) stencil thickness</p>

Manufacturing Guidelines

- 1) No Ultrasonic Cleaning: Do not subject the ANY1552 to an ultrasonic cleaning environment. Permanent damage or long term reliability issues to the MEMS structure may occur.
- 2) Do not apply underfill to the ANY1552. The device will not meet the frequency stability specification if underfill is applied.
- 3) Reflow profile, per JESD22-A113D.
- 4) For additional manufacturing guidelines and marking/tape-reel instructions, click on the following link:
<http://www.anyclk.com>

Ordering Information

Part number characters in blue represent the customer specific options. The other characters in the part number are fixed.

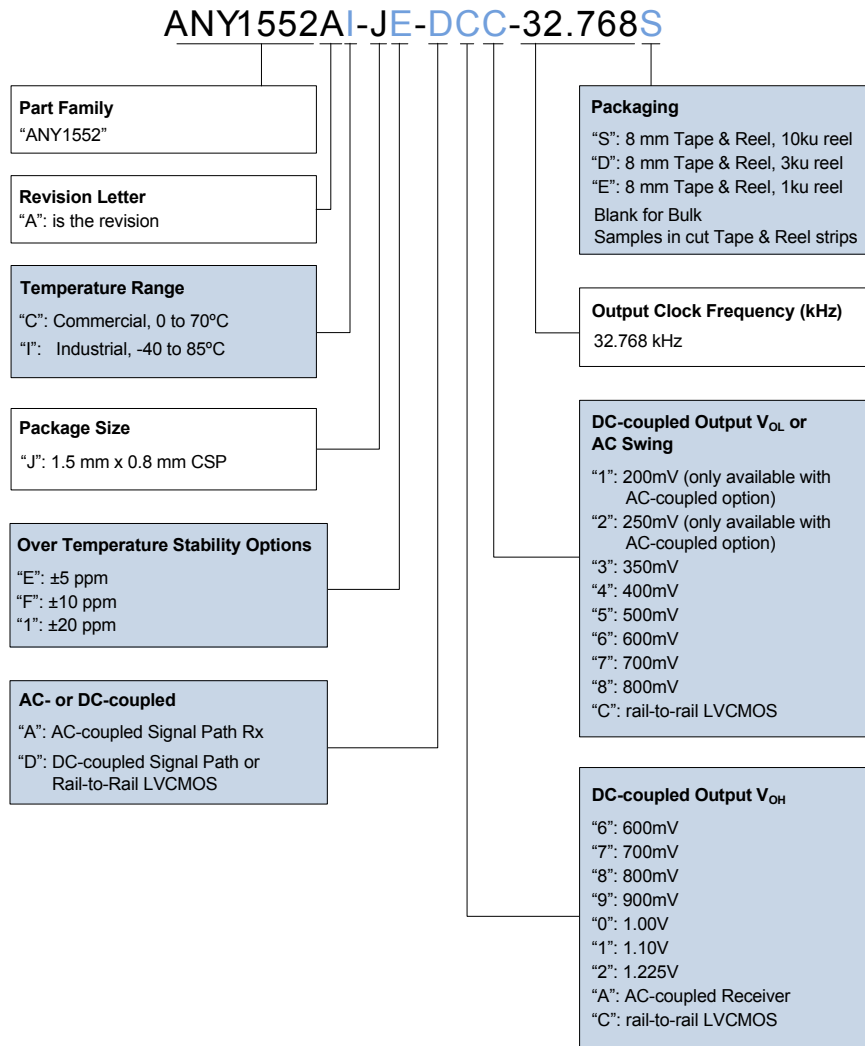

The following examples illustrate how to select the appropriate part number scheme:

Example: ANY1552AI-JE-DCC-32.768

- Industrial temperature range
- CSP package
- 5 ppm frequency stability over temp
- Output requirements:
 - a) Output frequency = 32.768 kHz
 - b) "D" = DC-coupled receiver
 - c) "C" = LVCMOS output swing
 - d) "C" = LVCMOS output swing

Revision History

Version	Release Date	Change Summary
1.0	9/17/14	Rev 0.9 Preliminary to Rev 1.0 Production Release <ul style="list-style-type: none">• Updated start-up time specification• Added typical operating plots• Removed SOT23 and 2012 SMD package options• Added "no underfill" in frequency stability specification condition• Added Manufacturing Guidelines section
1.1	10/14/14	<ul style="list-style-type: none">• Improved Start-up Time at Power-up spec• Added 5pF LVCMOS rise/fall time spec
1.2	11/10/14	<ul style="list-style-type: none">• Updated 5pF LVCMOS rise/fall time spec