

Schottky Barrier Rectifier Diodes

1N5817-1N5819

■ Features

- For Surface Mounted Applications
- Metal Silicon Junction, Majority Carrier Conduction
- Low Power Loss, High Efficiency
- High Forward Surge Current Capability

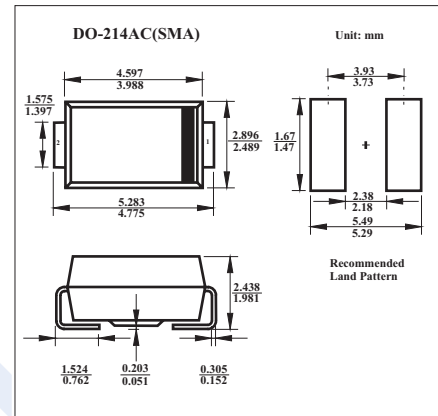

■ Maximum Ratings and Electrical Characteristics @ Ta = 25°C

Parameter	Symbol	Rating			Unit
		1N5817	1N5818	1N5819	
Maximum Repetitive Peak Reverse Voltage	VRRM	20	30	40	V
Maximum RMS voltage	VRMS	14	21	28	
Maximum DC Blocking Voltage	VDC	20	30	40	
Maximum Average Forward Rectified Current	I(AV)	1.0			A
Peak Forward Surge Current 8.3ms single half sine-wave superimposed on rated load (JEDEC Method)	IFSM	40			A
Maximum Instantaneous Forward Voltage at 1.0A	VF	0.45	0.55	0.55	V
Maximum DC Reverse Current TA=25°C	IR	0.5			mA
At Rated DC Blocking Voltage TA=100°C		6.0			
Typical Junction Capacitance *1	CJ	110			pF
Typical Thermal Resistance *2	RθJA	88.0			°C/W
Operating Junction Temperature Range	TJ	-65 to +125			°C
Storage Temperature Range	TSTG	-65 to +150			°C

*1 Measured at 1Mz and applied reverse voltage of 4.0V D.C.

*2 P.C.B mounted with 0.2X0.2"(5.0x5.0mm)copper pad areas

■ Marking

Part NO.	1N5817	1N5818	1N5819
Marking	SS12	SS13	SS14

1N5817-1N5819

Electrical Characteristics Curves

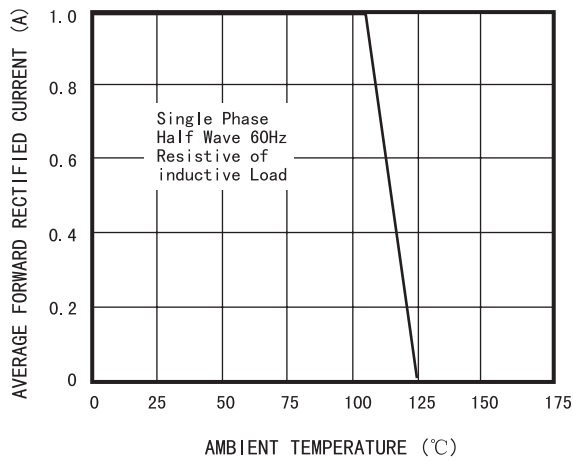

Forward Current Derating Curve

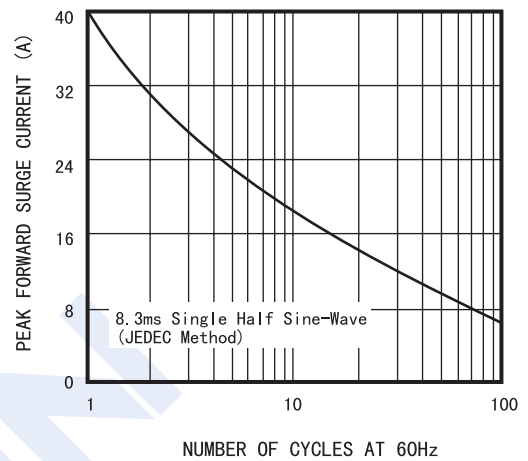

2-Maximum Non-Repetitive Peak Forward Surge Current

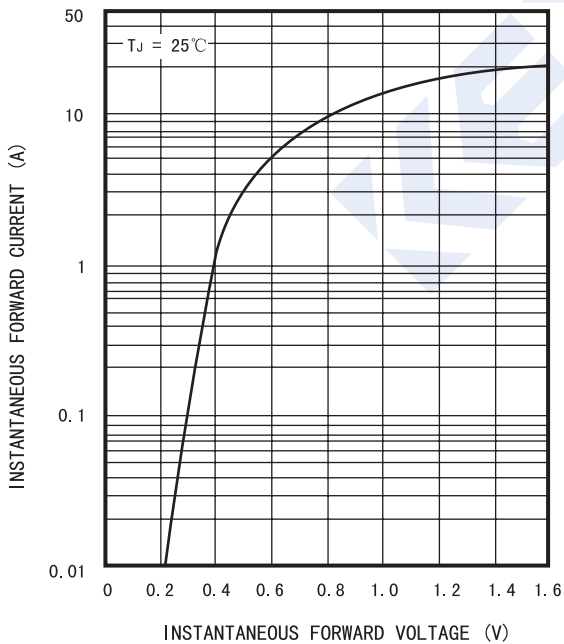

Typical Instantaneous Forward Characteristics

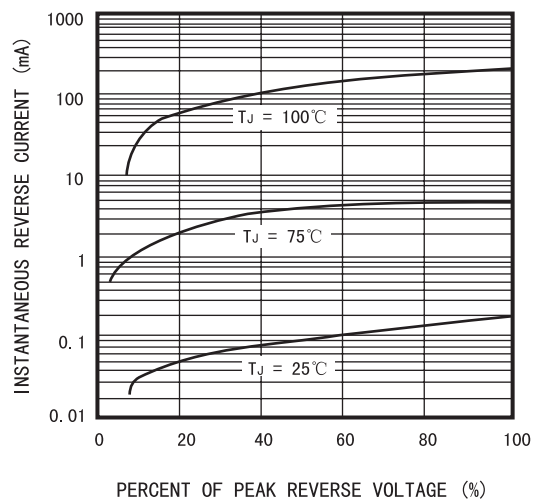

Typical Reverse Characteristics

1N5817-1N5819

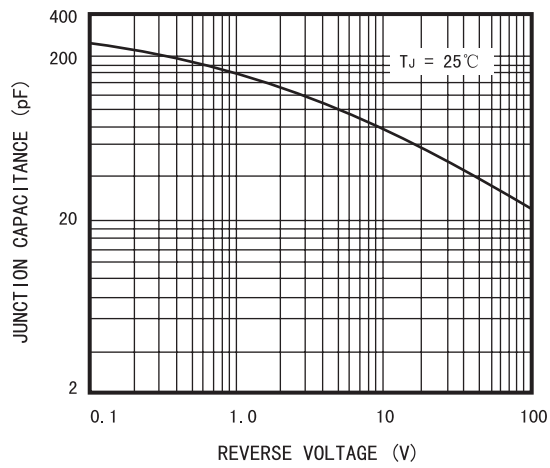

Typical Junction Capacitance

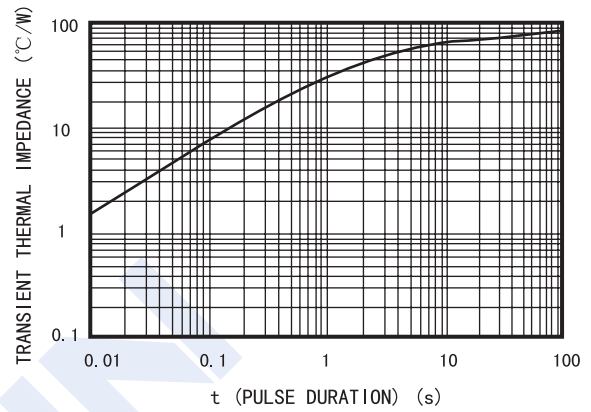

Typical Transient Thermal Impedance