

## SN74LV1T34 Single Power Supply Single Buffer GATE CMOS Logic Level Shifter

### 1 Features

- Single-Supply Voltage Translator at 5.0/3.3/2.5/1.8V  $V_{CC}$
  - Operating Range of 1.8V to 5.5V
  - Up Translation
    - 1.2V<sup>(1)</sup> to 1.8V at 1.8V  $V_{CC}$
    - 1.5V<sup>(1)</sup> to 2.5V at 2.5V  $V_{CC}$
    - 1.8V<sup>(1)</sup> to 3.3V at 3.3V  $V_{CC}$
    - 3.3V to 5.0V at 5.0V  $V_{CC}$
  - Down Translation
    - 3.3V to 1.8V at 1.8V  $V_{CC}$
    - 3.3V to 2.5V at 2.5V  $V_{CC}$
    - 5.0V to 3.3V at 3.3V  $V_{CC}$
  - Logic Output is Referenced to  $V_{CC}$
  - Output Drive
    - 8.0mA Output Drive at 5.0V
    - 7.0mA Output Drive at 3.3V
    - 3.0mA Output Drive at 1.8V
  - Characterized up to 50MHz at 3.3V  $V_{CC}$
  - 5.0V Tolerance on Input Pins
  - –40°C to 125°C Operating Temperature Range
  - Latch-Up Performance Exceeds 250mA Per JESD 17
  - ESD Performance Tested Per JESD 22
    - 2000-V Human-Body Model (A114-B, Class II)
    - 200-V Machine Model (A115-A)
    - 1000-V Charged-Device Model (C101)
  - Supports Standard Logic Pinouts
  - CMOS Output B Compatible with AUP1G and LVC1G Families
- (1) Refer to the  $V_{IH}/V_{IL}$  and output drive for lower  $V_{CC}$  condition

### 2 Applications

- Industrial controllers
- Telecom
- Portable applications
- Servers
- PC and notebooks
- Automotive

### 3 Description

SN74LV1T34 is a low voltage CMOS gate logic that operates at a wider voltage range for industrial, portable, telecom, and automotive applications. The output level is referenced to the supply voltage and is able to support 1.8V/2.5V/3.3V/5V CMOS levels.

The input is designed with a lower threshold circuit to match 1.8V input logic at  $V_{CC} = 3.3V$  and can be used in 1.8V to 3.3V level up translation. In addition, the 5V tolerant input pins enable down translation (e.g. 3.3V to 2.5V output at  $V_{CC} = 2.5V$ ). The wide  $V_{CC}$  range of 1.8V to 5.5V allows generation of desired output levels to connect to controllers or processors.

The SN74LV1T34 is designed with current-drive capability of 8 mA to reduce line reflections, overshoot, and undershoot caused by high-drive outputs.

#### Device Information

ORDER NUMBER	PACKAGE	BODY SIZE
SN74LV1T34DBVR	SOT-23 (5)	2,90mm x 1,60mm
SN74LV1T34DCKR	SC70 (5)	2,00mm x 1,25mm

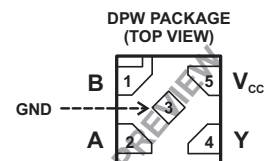
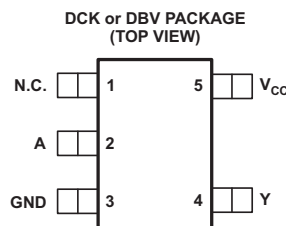

## Table of Contents

<b>1 Features</b> .....	<b>1</b>	4.6 Switching Characteristics .....	<b>8</b>
<b>2 Applications</b> .....	<b>1</b>	4.7 Operating Characteristics .....	<b>8</b>
<b>3 Description</b> .....	<b>1</b>	<b>5 Parameter Measurement Information</b> .....	<b>9</b>
<b>4 Revision History</b> .....	<b>2</b>	5.1 More Product Selection .....	<b>10</b>
4.1 Logic Diagram .....	<b>3</b>	<b>6 Device and Documentation Support</b> .....	<b>11</b>
4.2 Typical Design Examples .....	<b>5</b>	6.1 Trademarks .....	<b>11</b>
4.3 Absolute Maximum Ratings .....	<b>6</b>	6.2 Electrostatic Discharge Caution .....	<b>11</b>
4.4 Recommended Operating Conditions .....	<b>6</b>	6.3 Glossary .....	<b>11</b>
4.5 Electrical Characteristics .....	<b>7</b>	<b>7 Mechanical, Packaging, and Orderable Information</b> .....	<b>11</b>

## 4 Revision History

NOTE: Page numbers for previous revisions may differ from page numbers in the current version.

Changes from Original (December 2013) to Revision A	Page
• Updated document formatting. ....	<b>1</b>

Function Table

INPUT (Lower Level Input)	OUTPUT (V <sub>CC</sub> CMOS)
A	Y
H	H
L	L

SUPPLY V <sub>CC</sub> = 3.3V		
INPUT (Lower Level Input)		OUTPUT (V <sub>CC</sub> CMOS)
A	B	Y
V <sub>IH</sub> (min) = 1.35 V V <sub>IL</sub> (max) = 0.8 V		V <sub>OH</sub> (min) = 2.9 V V <sub>OL</sub> (max) = 0.2 V

4.1 Logic Diagram



Switching Characteristics at 50 MHz

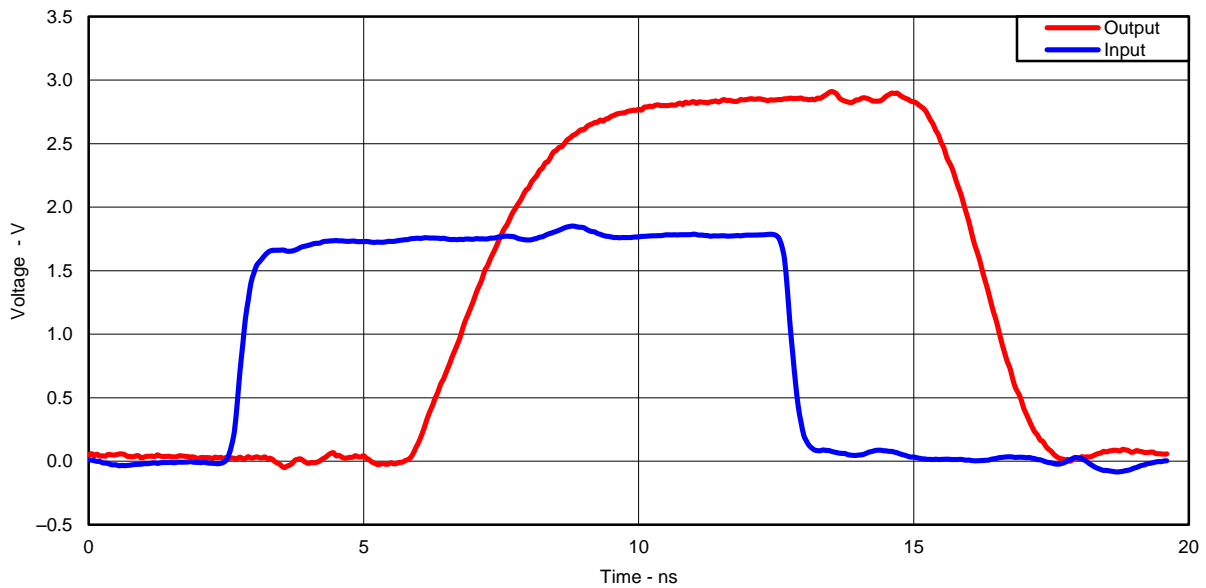

Figure 1. Excellent Signal Integrity (1.8V to 3.3V at 3.3V V<sub>CC</sub>)

Logic Diagram (continued)

Switching Characteristics at 50 MHz

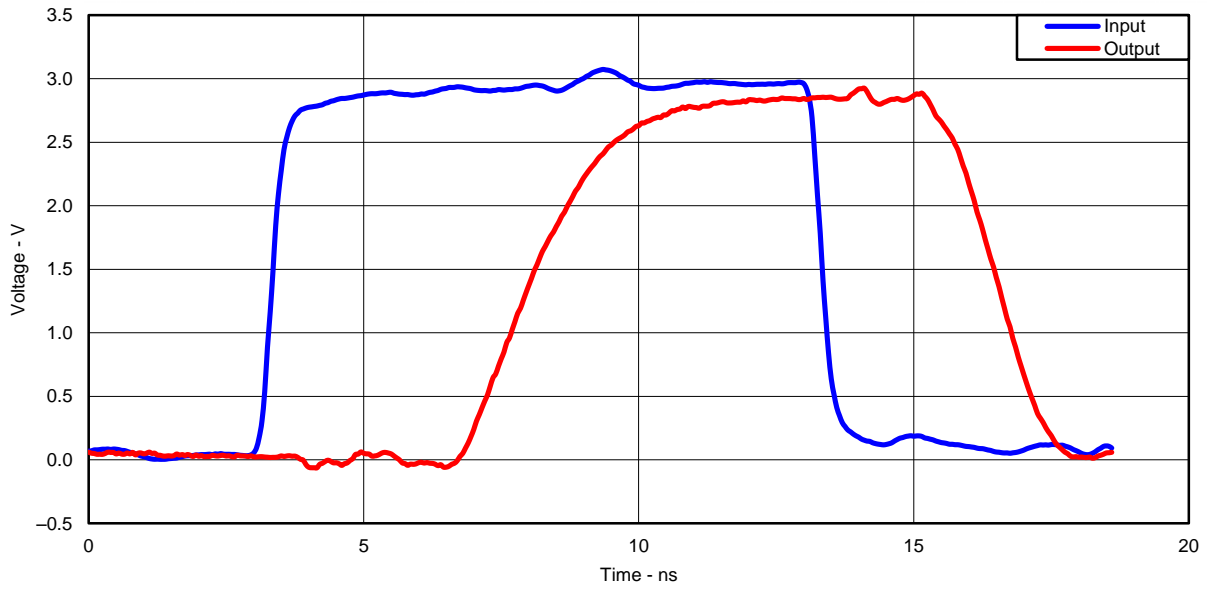

Figure 2. Excellent Signal Integrity (3.3V to 3.3V at 3.3V V<sub>CC</sub>)

Switching Characteristics at 15 MHz

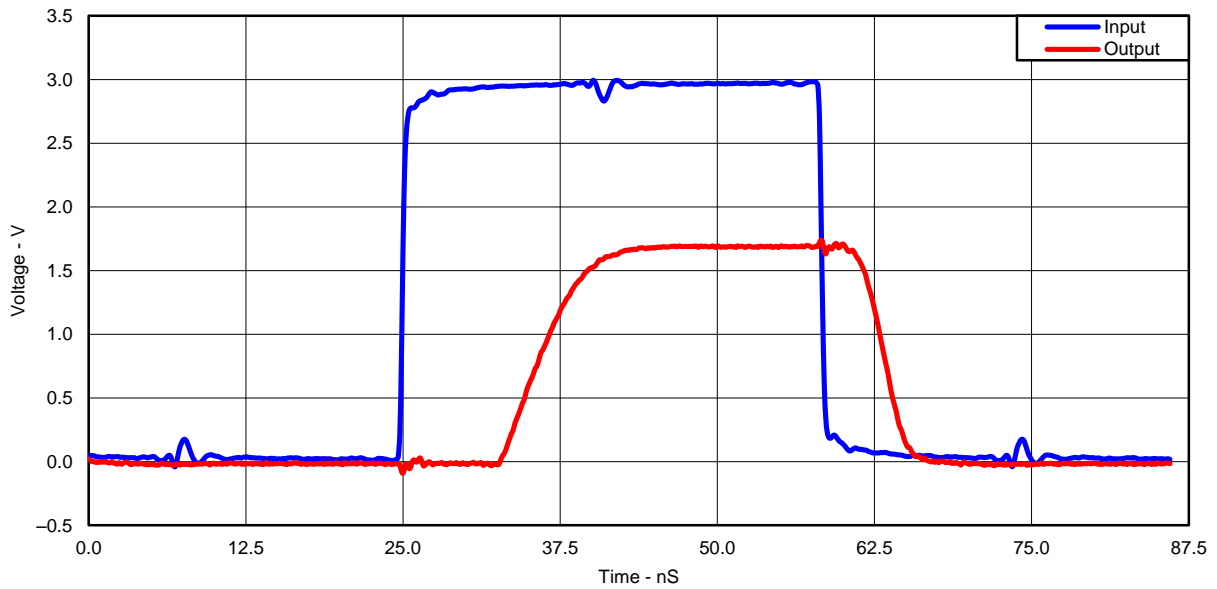

Figure 3. Excellent Signal Integrity (3.3V to 1.8V at 1.8V V<sub>CC</sub>)

## 4.2 Typical Design Examples

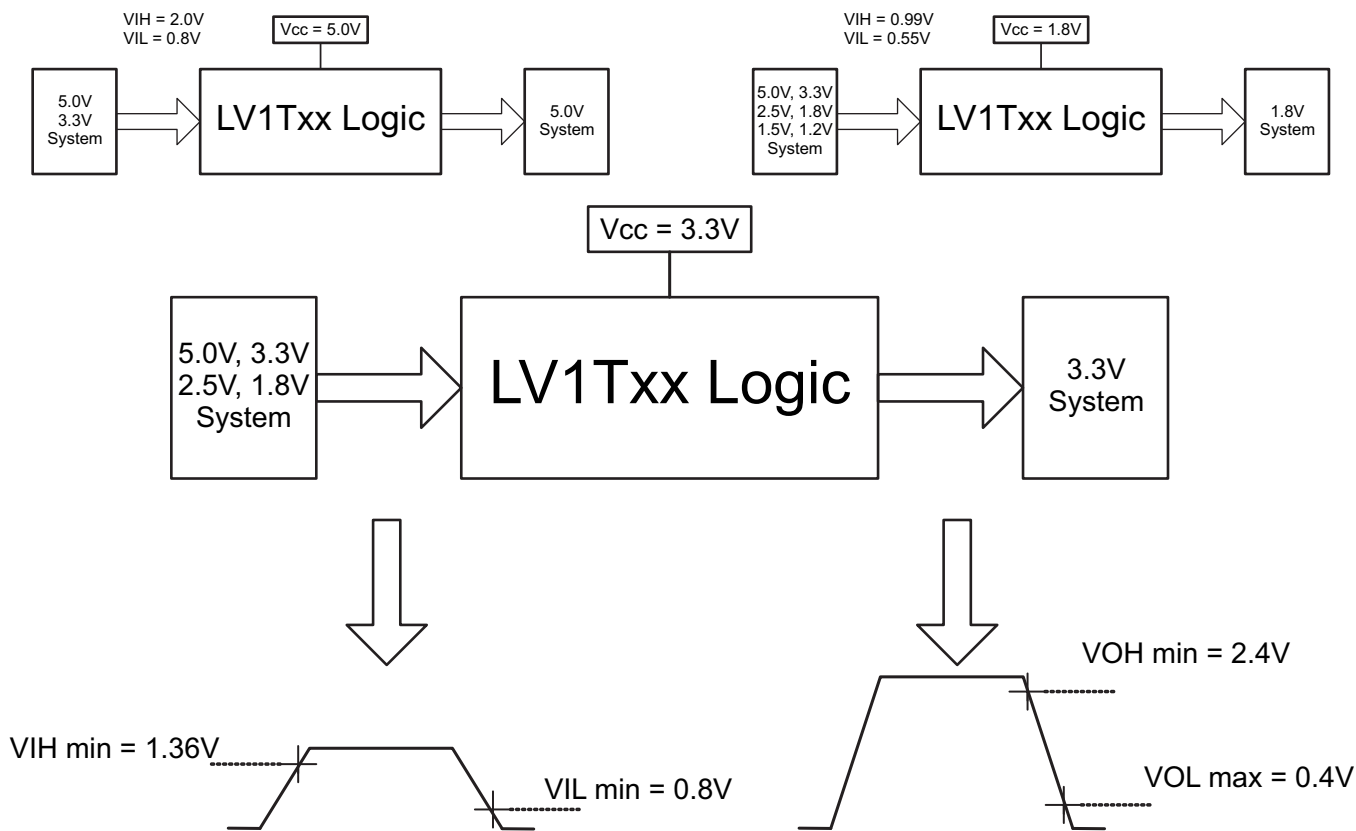

Figure 4. Switching Thresholds for 1.8-V to 3.3-V Translation

### 4.3 Absolute Maximum Ratings<sup>(1)</sup>

over operating free-air temperature range (unless otherwise noted)

		MIN	MAX	UNIT	
V <sub>CC</sub>	Supply voltage range	-0.5	7.0	V	
V <sub>I</sub>	Input voltage range <sup>(2)</sup>	-0.5	7.0	V	
V <sub>O</sub>	Voltage range applied to any output in the high-impedance or power-off state <sup>(2)</sup>	-0.5	4.6	V	
	Voltage range applied to any output in the high or low state <sup>(2)</sup>	-0.5	V <sub>CC</sub> + 0.5	V	
I <sub>IK</sub>	Input clamp current	V <sub>I</sub> < 0		-20	mA
I <sub>OK</sub>	Output clamp current	V <sub>O</sub> < 0 or V <sub>O</sub> > V <sub>CC</sub>		±20	mA
I <sub>O</sub>	Continuous output current			±25	mA
	Continuous current through VCC or GND			±50	mA
θ <sub>JA</sub>	Package thermal impedance <sup>(3)</sup>	DBV package		206	°C/W
		DCK package		252	
T <sub>stg</sub>	Storage temperature range	-65	150	°C	

- (1) Stresses beyond those listed under "absolute maximum ratings" may cause permanent damage to the device. These are stress ratings only, and functional operation of the device at these or any other conditions beyond those indicated under "recommended operating conditions" is not implied. Exposure to absolute-maximum-rated conditions for extended periods may affect device reliability.
- (2) The input negative-voltage and output voltage ratings may be exceeded if the input and output current ratings are observed.
- (3) The package thermal impedance is calculated in accordance with JESD 51-7.

### 4.4 Recommended Operating Conditions<sup>(1)</sup>

over operating free-air temperature range (unless otherwise noted)

		MIN	MAX	UNIT	
V <sub>CC</sub>	Supply voltage	1.6	5.5	V	
V <sub>I</sub>	Input voltage	0	5.5	V	
V <sub>O</sub>	Output voltage	0	V <sub>CC</sub>	V	
I <sub>OH</sub>	High-level output current	V <sub>CC</sub> = 1.8 V		-3.0	mA
		V <sub>CC</sub> = 2.5 V		-5.0	
		V <sub>CC</sub> = 3.3 V		-7.0	
		V <sub>CC</sub> = 5.0 V		-8.0	
I <sub>OL</sub>	Low-level output current	V <sub>CC</sub> = 1.8 V		3.0	mA
		V <sub>CC</sub> = 2.5 V		5.0	
		V <sub>CC</sub> = 3.3 V		7.0	
		V <sub>CC</sub> = 5.0 V		8.0	
Δt/Δv	Input transition rise or fall rate	V <sub>CC</sub> = 1.8 V		20	ns/V
		V <sub>CC</sub> = 3.3 V or 2.5 V		20	
		V <sub>CC</sub> = 5.0 V		20	
T <sub>A</sub>	Operating free-air temperature	-40	125	°C	

- (1) All unused inputs of the device must be held at V<sub>CC</sub> or GND to ensure proper device operation. Refer to the TI application report, *Implications of Slow or Floating CMOS Inputs*, literature number [SCBA004](#).

## 4.5 Electrical Characteristics

over operating free-air temperature range (unless otherwise noted)

PARAMETER	TEST CONDITIONS	V <sub>CC</sub>	T <sub>A</sub> = 25°C			T <sub>A</sub> = -40°C to 125°C		UNIT
			MIN	TYP	MAX	MIN	MAX	
V <sub>IH</sub> High-level input voltage		V <sub>CC</sub> = 1.65 V to 1.8 V	0.95			1.0		V
		V <sub>CC</sub> = 2.0 V	0.99			1.03		
		V <sub>CC</sub> = 2.25 V to 2.5 V	1.145			1.18		
		V <sub>CC</sub> = 2.75 V	1.22			1.25		
		V <sub>CC</sub> = 3.0 V to 3.3 V	1.37			1.39		
		V <sub>CC</sub> = 3.6 V	1.47			1.48		
		V <sub>CC</sub> = 4.5 V to 5.0 V	2.02			2.03		
		V <sub>CC</sub> = 5.5 V	2.1			2.11		
V <sub>IL</sub> Low-level input voltage		V <sub>CC</sub> = 1.65 V to 2.0 V				0.57	0.55	V
		V <sub>CC</sub> = 2.25 V to 2.75 V				0.75	0.71	
		V <sub>CC</sub> = 3.0 V to 3.6 V				0.8	0.65	
		V <sub>CC</sub> = 4.5 V to 5.5 V				0.8	0.8	
V <sub>OH</sub>	I <sub>OH</sub> = -20 μA	1.65 V to 5.5 V	V <sub>CC</sub> - 0.1			V <sub>CC</sub> - 0.1		V
	I <sub>OH</sub> = -2.0 mA	1.65 V	1.28			1.21		
		1.8 V	1.5			1.45		
	I <sub>OH</sub> = -3.0 mA	2.3 V	2.0			1.93		V
	I <sub>OH</sub> = -3.0 mA	2.5 V	2.25			2.15		
	I <sub>OH</sub> = -3.0 mA	3.0 V	2.78			2.7		
	I <sub>OH</sub> = -5.5 mA		2.6			2.49		
	I <sub>OH</sub> = -5.5 mA	3.3 V	2.9			2.8		
	I <sub>OH</sub> = -4.0 mA	4.5 V	4.2			4.1		
	I <sub>OH</sub> = -8.0 mA		4.1			3.95		
I <sub>OH</sub> = -8.0 mA	5.0 V	4.6			4.5			
V <sub>OL</sub>	I <sub>OL</sub> = 20 μA	1.65 V to 5.5 V				0.1	0.1	V
	I <sub>OL</sub> = 2.0 mA	1.65 V				0.2	0.25	
	I <sub>OL</sub> = 3.0 mA	2.3 V				0.15	0.2	
	I <sub>OL</sub> = 3.0 mA	3.0 V				0.11	0.15	
	I <sub>OL</sub> = 5.5 mA					0.21	0.252	
	I <sub>OL</sub> = 4.0 mA	4.5 V				0.15	0.2	
	I <sub>OL</sub> = 8.0 mA					0.3	0.35	
I <sub>I</sub> A input	V <sub>I</sub> = 0 V or V <sub>CC</sub>	0 V, 1.8 V, 2.5 V, 3.3 V, 5.5 V				0.1	±1.0	μA
I <sub>CC</sub>	V <sub>I</sub> = 0 V or V <sub>CC</sub> ; I <sub>O</sub> = 0; Open on loading	5.0 V				1.0	10.0	μA
		3.3 V				1.0	10.0	
		2.5 V				1.0	10.0	
		1.8 V				1.0	10.0	
ΔI <sub>CC</sub>	One input at 0.3 V or 3.4 V Other inputs at 0 or V <sub>CC</sub> , I <sub>O</sub> = 0	5.5 V				1.35	1.5	mA
	One input at 0.3 V or 1.1 V Other inputs at 0 or V <sub>CC</sub> , I <sub>O</sub> = 0	1.8 V				10.0	10.0	μA
C <sub>i</sub>	V <sub>I</sub> = V <sub>CC</sub> or GND	3.3 V	2.0	10.0	2.0	10.0	pF	
C <sub>o</sub>	V <sub>O</sub> = V <sub>CC</sub> or GND	3.3 V	2.5		2.5		pF	

## 4.6 Switching Characteristics

over operating free-air temperature range (unless otherwise noted)

PARAMETER	FROM (INPUT)	TO (OUTPUT)	FREQUENCY (TYP)	V <sub>CC</sub>	C <sub>L</sub>	T <sub>A</sub> = 25°C			T <sub>A</sub> = –65°C to 125°C			UNIT
						MIN	TYP	MAX	MIN	TYP	MAX	
t <sub>pd</sub>	Any In	Y	DC to 50MHz	5.0 V	15 pF	2.7	5.5	3.4	6.5	ns		
					30 pF	3.0	6.5	4.1	7.5			
				3.3 V	15 pF	4.0	7.0	5.0	8.0	ns		
					30 pF	4.9	8.0	6.0	9.0			
			DC to 25MHz	2.5 V	15 pF	5.8	8.5	6.8	9.5	ns		
					30 pF	6.5	9.5	7.5	10.5			
				DC to 15MHz	1.8 V	15 pF	10.5	13.0	11.8	14.0	ns	
						30 pF	12.0	14.5	12.0	15.5		

## 4.7 Operating Characteristics

over operating free-air temperature range (unless otherwise noted)

PARAMETER		TEST CONDITIONS	V <sub>CC</sub>	TYP	UNIT
C <sub>pd</sub>	Power dissipation capacitance	f = 1 MHz and 10 MHz	1.8 V ± 0.15 V	14	pF
			2.5 V ± 0.2 V	14	
			3.3 V ± 0.3 V	14	
			5.0 V ± 0.5 V	14	



## 5 Parameter Measurement Information

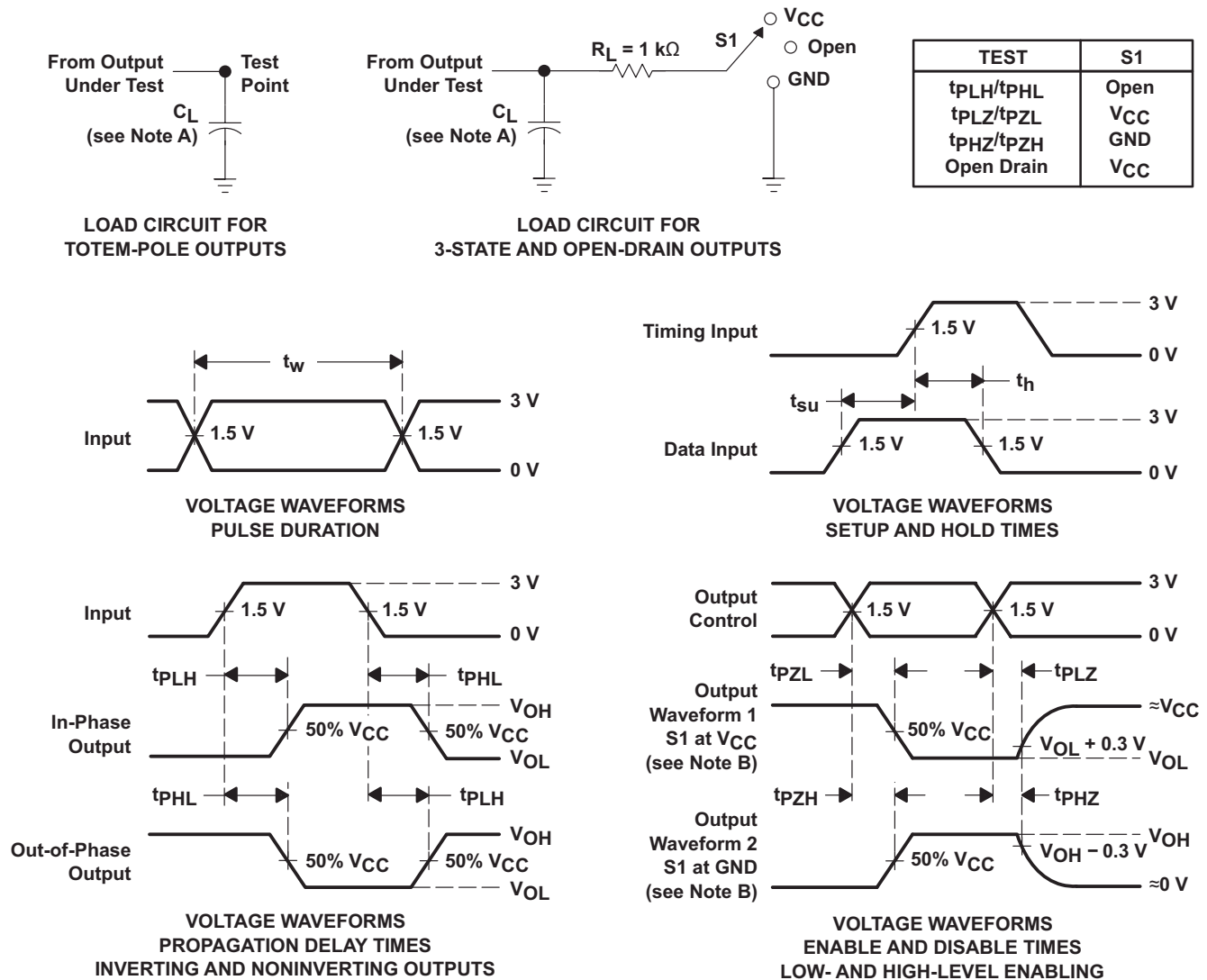

- NOTES: A.  $C_L$  includes probe and jig capacitance.  
 B. Waveform 1 is for an output with internal conditions such that the output is low, except when disabled by the output control. Waveform 2 is for an output with internal conditions such that the output is high, except when disabled by the output control.  
 C. All input pulses are supplied by generators having the following characteristics: PRR  $\leq$  1 MHz,  $Z_O = 50\ \Omega$ ,  $t_r \leq 3\text{ ns}$ ,  $t_f \leq 3\text{ ns}$ .  
 D. The outputs are measured one at a time, with one input transition per measurement.  
 E. All parameters and waveforms are not applicable to all devices.

Figure 5. Load Circuit and Voltage Waveforms

## Parameter Measurement Information (continued)

### 5.1 More Product Selection

DEVICE	PACKAGE	DESCRIPTION
SN74LV1T00	DCK, DBV	2-Input Positive-NAND Gate
SN74LV1T02	DCK, DBV	2-Input Positive-NOR Gate
SN74LV1T04	DCK, DBV	Inverter Gate
SN74LV1T08	DCK, DBV	2-Input Positive-AND Gate
SN74LV1T34	DCK, DBV, DPW	Single Buffer Gate
SN74LV1T14	DCK, DBV	Single Schmitt-Trigger Inverter Gate
SN74LV1T32	DCK, DBV	2-Input Positive-OR Gate
SN74LV1T86	DCK, DBV	Single 2-Input Exclusive-Or Gate
SN74LV1T125	DCK, DBV	Single Buffer Gate with 3-state Output
SN74LV1T126	DCK, DBV	Single Buffer Gate with 3-state Output
SN74LV4T125	RGY, PW	Quadruple Bus Buffer Gate With 3-State Outputs

## 6 Device and Documentation Support

### 6.1 Trademarks

All trademarks are the property of their respective owners.

### 6.2 Electrostatic Discharge Caution



These devices have limited built-in ESD protection. The leads should be shorted together or the device placed in conductive foam during storage or handling to prevent electrostatic damage to the MOS gates.

### 6.3 Glossary

[SLYZ022](#) — *TI Glossary*.

This glossary lists and explains terms, acronyms and definitions.

## 7 Mechanical, Packaging, and Orderable Information

The following packaging information and addendum reflect the most current data available for the designated devices. This data is subject to change without notice and revision of this document.

**PACKAGING INFORMATION**

Orderable Device	Status (1)	Package Type	Package Drawing	Pins	Package Qty	Eco Plan (2)	Lead/Ball Finish (6)	MSL Peak Temp (3)	Op Temp (°C)	Device Marking (4/5)	Samples
SN74LV1T34DBVR	ACTIVE	SOT-23	DBV	5	3000	Green (RoHS & no Sb/Br)	CU NIPDAU	Level-1-260C-UNLIM	-40 to 125	(NEJ3 ~ NEJS)	<a href="#">Samples</a>
SN74LV1T34DCKR	ACTIVE	SC70	DCK	5	3000	Green (RoHS & no Sb/Br)	CU NIPDAU	Level-1-260C-UNLIM	-40 to 125	(WJ3 ~ WJS)	<a href="#">Samples</a>

(1) The marketing status values are defined as follows:

**ACTIVE:** Product device recommended for new designs.

**LIFEBUY:** TI has announced that the device will be discontinued, and a lifetime-buy period is in effect.

**NRND:** Not recommended for new designs. Device is in production to support existing customers, but TI does not recommend using this part in a new design.

**PREVIEW:** Device has been announced but is not in production. Samples may or may not be available.

**OBSELETE:** TI has discontinued the production of the device.

(2) Eco Plan - The planned eco-friendly classification: Pb-Free (RoHS), Pb-Free (RoHS Exempt), or Green (RoHS & no Sb/Br) - please check <http://www.ti.com/productcontent> for the latest availability information and additional product content details.

**TBD:** The Pb-Free/Green conversion plan has not been defined.

**Pb-Free (RoHS):** TI's terms "Lead-Free" or "Pb-Free" mean semiconductor products that are compatible with the current RoHS requirements for all 6 substances, including the requirement that lead not exceed 0.1% by weight in homogeneous materials. Where designed to be soldered at high temperatures, TI Pb-Free products are suitable for use in specified lead-free processes.

**Pb-Free (RoHS Exempt):** This component has a RoHS exemption for either 1) lead-based flip-chip solder bumps used between the die and package, or 2) lead-based die adhesive used between the die and leadframe. The component is otherwise considered Pb-Free (RoHS compatible) as defined above.

**Green (RoHS & no Sb/Br):** TI defines "Green" to mean Pb-Free (RoHS compatible), and free of Bromine (Br) and Antimony (Sb) based flame retardants (Br or Sb do not exceed 0.1% by weight in homogeneous material)

(3) MSL, Peak Temp. - The Moisture Sensitivity Level rating according to the JEDEC industry standard classifications, and peak solder temperature.

(4) There may be additional marking, which relates to the logo, the lot trace code information, or the environmental category on the device.

(5) Multiple Device Markings will be inside parentheses. Only one Device Marking contained in parentheses and separated by a "~" will appear on a device. If a line is indented then it is a continuation of the previous line and the two combined represent the entire Device Marking for that device.

(6) Lead/Ball Finish - Orderable Devices may have multiple material finish options. Finish options are separated by a vertical ruled line. Lead/Ball Finish values may wrap to two lines if the finish value exceeds the maximum column width.

**Important Information and Disclaimer:**The information provided on this page represents TI's knowledge and belief as of the date that it is provided. TI bases its knowledge and belief on information provided by third parties, and makes no representation or warranty as to the accuracy of such information. Efforts are underway to better integrate information from third parties. TI has taken and continues to take reasonable steps to provide representative and accurate information but may not have conducted destructive testing or chemical analysis on incoming materials and chemicals. TI and TI suppliers consider certain information to be proprietary, and thus CAS numbers and other limited information may not be available for release.

In no event shall TI's liability arising out of such information exceed the total purchase price of the TI part(s) at issue in this document sold by TI to Customer on an annual basis.

## TAPE AND REEL INFORMATION



### QUADRANT ASSIGNMENTS FOR PIN 1 ORIENTATION IN TAPE



\*All dimensions are nominal

Device	Package Type	Package Drawing	Pins	SPQ	Reel Diameter (mm)	Reel Width W1 (mm)	A0 (mm)	B0 (mm)	K0 (mm)	P1 (mm)	W (mm)	Pin1 Quadrant
SN74LV1T34DBVR	SOT-23	DBV	5	3000	180.0	8.4	3.23	3.17	1.37	4.0	8.0	Q3
SN74LV1T34DCKR	SC70	DCK	5	3000	178.0	9.2	2.4	2.4	1.22	4.0	8.0	Q3

**TAPE AND REEL BOX DIMENSIONS**

\*All dimensions are nominal

Device	Package Type	Package Drawing	Pins	SPQ	Length (mm)	Width (mm)	Height (mm)
SN74LV1T34DBVR	SOT-23	DBV	5	3000	202.0	201.0	28.0
SN74LV1T34DCKR	SC70	DCK	5	3000	180.0	180.0	18.0

DBV (R-PDSO-G5)

PLASTIC SMALL-OUTLINE PACKAGE



- NOTES:
- A. All linear dimensions are in millimeters.
  - B. This drawing is subject to change without notice.
  - C. Body dimensions do not include mold flash or protrusion. Mold flash and protrusion shall not exceed 0.15 per side.
  - D. Falls within JEDEC MO-178 Variation AA.



DBV (R-PDSO-G5)

PLASTIC SMALL OUTLINE



- NOTES:
- A. All linear dimensions are in millimeters.
  - B. This drawing is subject to change without notice.
  - C. Customers should place a note on the circuit board fabrication drawing not to alter the center solder mask defined pad.
  - D. Publication IPC-7351 is recommended for alternate designs.
  - E. Laser cutting apertures with trapezoidal walls and also rounding corners will offer better paste release. Customers should contact their board assembly site for stencil design recommendations. Example stencil design based on a 50% volumetric metal load solder paste. Refer to IPC-7525 for other stencil recommendations.

DCK (R-PDSO-G5)

PLASTIC SMALL-OUTLINE PACKAGE



- NOTES:
- A. All linear dimensions are in millimeters.
  - B. This drawing is subject to change without notice.
  - C. Body dimensions do not include mold flash or protrusion. Mold flash and protrusion shall not exceed 0.15 per side.
  - D. Falls within JEDEC MO-203 variation AA.

DCK (R-PDSO-G5)

PLASTIC SMALL OUTLINE



- NOTES:
- All linear dimensions are in millimeters.
  - This drawing is subject to change without notice.
  - Customers should place a note on the circuit board fabrication drawing not to alter the center solder mask defined pad.
  - Publication IPC-7351 is recommended for alternate designs.
  - Laser cutting apertures with trapezoidal walls and also rounding corners will offer better paste release. Customers should contact their board assembly site for stencil design recommendations. Example stencil design based on a 50% volumetric metal load solder paste. Refer to IPC-7525 for other stencil recommendations.

## IMPORTANT NOTICE

Texas Instruments Incorporated and its subsidiaries (TI) reserve the right to make corrections, enhancements, improvements and other changes to its semiconductor products and services per JESD46, latest issue, and to discontinue any product or service per JESD48, latest issue. Buyers should obtain the latest relevant information before placing orders and should verify that such information is current and complete. All semiconductor products (also referred to herein as "components") are sold subject to TI's terms and conditions of sale supplied at the time of order acknowledgment.

TI warrants performance of its components to the specifications applicable at the time of sale, in accordance with the warranty in TI's terms and conditions of sale of semiconductor products. Testing and other quality control techniques are used to the extent TI deems necessary to support this warranty. Except where mandated by applicable law, testing of all parameters of each component is not necessarily performed.

TI assumes no liability for applications assistance or the design of Buyers' products. Buyers are responsible for their products and applications using TI components. To minimize the risks associated with Buyers' products and applications, Buyers should provide adequate design and operating safeguards.

TI does not warrant or represent that any license, either express or implied, is granted under any patent right, copyright, mask work right, or other intellectual property right relating to any combination, machine, or process in which TI components or services are used. Information published by TI regarding third-party products or services does not constitute a license to use such products or services or a warranty or endorsement thereof. Use of such information may require a license from a third party under the patents or other intellectual property of the third party, or a license from TI under the patents or other intellectual property of TI.

Reproduction of significant portions of TI information in TI data books or data sheets is permissible only if reproduction is without alteration and is accompanied by all associated warranties, conditions, limitations, and notices. TI is not responsible or liable for such altered documentation. Information of third parties may be subject to additional restrictions.

Resale of TI components or services with statements different from or beyond the parameters stated by TI for that component or service voids all express and any implied warranties for the associated TI component or service and is an unfair and deceptive business practice. TI is not responsible or liable for any such statements.

Buyer acknowledges and agrees that it is solely responsible for compliance with all legal, regulatory and safety-related requirements concerning its products, and any use of TI components in its applications, notwithstanding any applications-related information or support that may be provided by TI. Buyer represents and agrees that it has all the necessary expertise to create and implement safeguards which anticipate dangerous consequences of failures, monitor failures and their consequences, lessen the likelihood of failures that might cause harm and take appropriate remedial actions. Buyer will fully indemnify TI and its representatives against any damages arising out of the use of any TI components in safety-critical applications.

In some cases, TI components may be promoted specifically to facilitate safety-related applications. With such components, TI's goal is to help enable customers to design and create their own end-product solutions that meet applicable functional safety standards and requirements. Nonetheless, such components are subject to these terms.

No TI components are authorized for use in FDA Class III (or similar life-critical medical equipment) unless authorized officers of the parties have executed a special agreement specifically governing such use.

Only those TI components which TI has specifically designated as military grade or "enhanced plastic" are designed and intended for use in military/aerospace applications or environments. Buyer acknowledges and agrees that any military or aerospace use of TI components which have **not** been so designated is solely at the Buyer's risk, and that Buyer is solely responsible for compliance with all legal and regulatory requirements in connection with such use.

TI has specifically designated certain components as meeting ISO/TS16949 requirements, mainly for automotive use. In any case of use of non-designated products, TI will not be responsible for any failure to meet ISO/TS16949.

### Products

Audio	<a href="http://www.ti.com/audio">www.ti.com/audio</a>
Amplifiers	<a href="http://amplifier.ti.com">amplifier.ti.com</a>
Data Converters	<a href="http://dataconverter.ti.com">dataconverter.ti.com</a>
DLP® Products	<a href="http://www.dlp.com">www.dlp.com</a>
DSP	<a href="http://dsp.ti.com">dsp.ti.com</a>
Clocks and Timers	<a href="http://www.ti.com/clocks">www.ti.com/clocks</a>
Interface	<a href="http://interface.ti.com">interface.ti.com</a>
Logic	<a href="http://logic.ti.com">logic.ti.com</a>
Power Mgmt	<a href="http://power.ti.com">power.ti.com</a>
Microcontrollers	<a href="http://microcontroller.ti.com">microcontroller.ti.com</a>
RFID	<a href="http://www.ti-rfid.com">www.ti-rfid.com</a>
OMAP Applications Processors	<a href="http://www.ti.com/omap">www.ti.com/omap</a>
Wireless Connectivity	<a href="http://www.ti.com/wirelessconnectivity">www.ti.com/wirelessconnectivity</a>

### Applications

Automotive and Transportation	<a href="http://www.ti.com/automotive">www.ti.com/automotive</a>
Communications and Telecom	<a href="http://www.ti.com/communications">www.ti.com/communications</a>
Computers and Peripherals	<a href="http://www.ti.com/computers">www.ti.com/computers</a>
Consumer Electronics	<a href="http://www.ti.com/consumer-apps">www.ti.com/consumer-apps</a>
Energy and Lighting	<a href="http://www.ti.com/energy">www.ti.com/energy</a>
Industrial	<a href="http://www.ti.com/industrial">www.ti.com/industrial</a>
Medical	<a href="http://www.ti.com/medical">www.ti.com/medical</a>
Security	<a href="http://www.ti.com/security">www.ti.com/security</a>
Space, Avionics and Defense	<a href="http://www.ti.com/space-avionics-defense">www.ti.com/space-avionics-defense</a>
Video and Imaging	<a href="http://www.ti.com/video">www.ti.com/video</a>

### TI E2E Community

[e2e.ti.com](http://e2e.ti.com)