

1 適用範圍:

1.1 本承認書適用於本公司所生產的無鉛、無鹵素之RTT系列厚膜晶片電阻器。

1.2 本公司之無鉛產品意指符合RoHS要求的端電極無鉛，而存在於電阻層玻璃材料中的鉛是符合RoHS的鉛排外條款。

2 型別名稱：

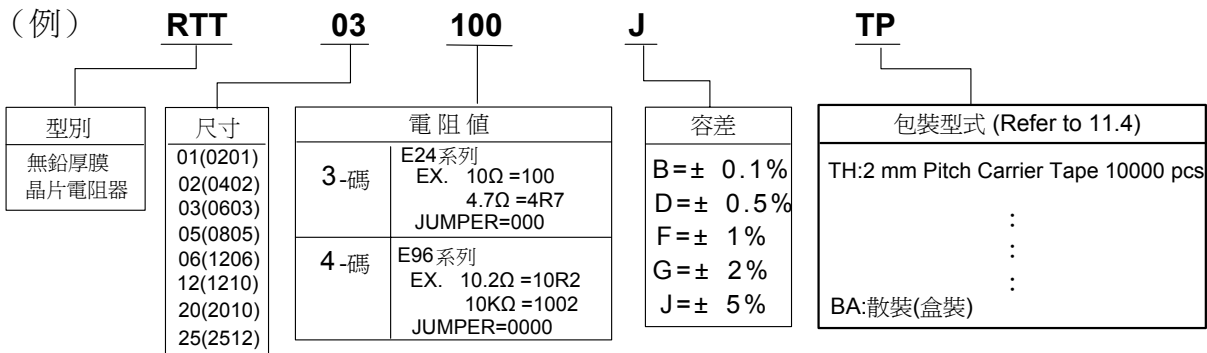

3 規格表:

3.1 阻值範圍: $\geq 1\Omega$ & 0Ω

型別	額定 功率	最高額 定電壓	最高 過負荷 電壓	T.C.R (ppm/°C) 溫度係數	阻值範圍				JUMPER (0Ω) 額定電流		JUMPER (0Ω) 阻值	
					B(± 0.1%) E-24、E-96	D(± 0.5%) E-24、E-96	F(± 1%) E-24、E-96	G(± 2%)、J(± 5%) E-24	J (± 5%)	F (± 1%)	J (± 5%)	F (± 1%)
RTT01 (0201)	1/20 w	25V	50V	-200 +400	-----	1Ω ≤ R < 10Ω	1Ω ≤ R < 10Ω	1Ω ≤ R < 10Ω	0.5A	0.5A	50mΩ MAX.	35mΩ MAX.
				± 200	-----	10Ω ≤ R ≤ 10MΩ	10Ω ≤ R ≤ 10MΩ	10Ω ≤ R ≤ 10MΩ				
RTT02 (0402)	1/16 w	50V	100V	± 100	100Ω ≤ R ≤ 1MΩ	10Ω ≤ R ≤ 1MΩ	10Ω ≤ R ≤ 22MΩ	10Ω ≤ R ≤ 22MΩ	1A	1.5A	50mΩ MAX.	20mΩ MAX.
				± 200	-----	-----	1Ω ≤ R < 10Ω	1Ω ≤ R < 10Ω				
RTT03 (0603)	1/10 w	75V	150V	± 100	100Ω ≤ R ≤ 1MΩ	10Ω ≤ R ≤ 1MΩ	10Ω ≤ R ≤ 22MΩ	10Ω ≤ R ≤ 22MΩ	1A	2A	50mΩ MAX.	20mΩ MAX.
				± 200	-----	1Ω ≤ R < 10Ω	1Ω ≤ R < 10Ω	1Ω ≤ R < 10Ω				
RTT05 (0805)	1/8 w	150V	300V	± 100	100Ω ≤ R ≤ 1MΩ	10Ω ≤ R ≤ 1MΩ	10Ω ≤ R ≤ 27MΩ	10Ω ≤ R ≤ 27MΩ	2A	2.5A	50mΩ MAX.	20mΩ MAX.
				± 200	-----	1Ω ≤ R < 10Ω	1Ω ≤ R < 10Ω	1Ω ≤ R < 10Ω				
RTT06 (1206)	1/4 w	200V	400V	± 100	10Ω ≤ R ≤ 1MΩ	10Ω ≤ R ≤ 1MΩ	10Ω ≤ R ≤ 27MΩ	10Ω ≤ R ≤ 27MΩ	2A	3.5A	50mΩ MAX.	20mΩ MAX.
				± 200	3Ω ≤ R < 10Ω	1Ω ≤ R < 10Ω	1Ω ≤ R < 10Ω	1Ω ≤ R < 10Ω				
RTT12 (1210)	1/2 w	200V	400V	± 100	100Ω ≤ R ≤ 1MΩ	10Ω ≤ R ≤ 1MΩ	10Ω ≤ R ≤ 27MΩ	10Ω ≤ R ≤ 27MΩ	2A	4A	50mΩ MAX.	20mΩ MAX.
				± 200	-----	-----	1Ω ≤ R < 10Ω	1Ω ≤ R < 10Ω				
RTT20 (2010)	3/4 w	200V	400V	± 100	100Ω ≤ R ≤ 1MΩ	10Ω ≤ R ≤ 1MΩ	10Ω ≤ R ≤ 20MΩ	10Ω ≤ R ≤ 20MΩ	2A	5A	50mΩ MAX.	20mΩ MAX.
				± 200	-----	-----	1Ω ≤ R < 10Ω	1Ω ≤ R < 10Ω				
RTT25 (2512)	1 w	200V	400V	± 100	100Ω ≤ R ≤ 1MΩ	10Ω ≤ R ≤ 1MΩ	10Ω ≤ R ≤ 20MΩ	10Ω ≤ R ≤ 20MΩ	2A	7A	50mΩ MAX.	20mΩ MAX.
				± 200	-----	-----	1Ω ≤ R < 10Ω	1Ω ≤ R < 10Ω				
使用溫度範圍				-55°C ~ +155°C (0201: -55°C ~ +125°C)								

3.2 阻值範圍: $<1\Omega$

型別	額定功率	最高額定電流	最高過負荷電流	T.C.R (ppm / °C) 溫度係數	阻值範圍
					F($\pm 1\%$)、G($\pm 2\%$)、J($\pm 5\%$) E-24、E-96
RTT02 (0402)	1/16W	1.58A	3.95A	± 1500	$25\text{ m}\Omega \leq R < 37\text{ m}\Omega$
				± 1200	$37\text{ m}\Omega \leq R < 60\text{ m}\Omega$
				± 600	$60\text{ m}\Omega \leq R < 200\text{ m}\Omega$
				± 300	$200\text{ m}\Omega \leq R < 400\text{ m}\Omega$
				± 250	$400\text{ m}\Omega \leq R < 600\text{ m}\Omega$
				± 200	$600\text{ m}\Omega \leq R < 1000\text{ m}\Omega$
RTT03 (0603)	1/10W	3.16A	7.91A	± 1500	$10\text{ m}\Omega \leq R < 37\text{ m}\Omega$
				± 1200	$37\text{ m}\Omega \leq R < 60\text{ m}\Omega$
				± 600	$60\text{ m}\Omega \leq R < 100\text{ m}\Omega$
				± 300	$100\text{ m}\Omega \leq R < 200\text{ m}\Omega$
				± 600	$200\text{ m}\Omega \leq R < 500\text{ m}\Omega$
				± 400	$500\text{ m}\Omega \leq R < 1000\text{ m}\Omega$
RTT05 (0805)	1/8W	3.53A	8.82A	± 1500	$10\text{ m}\Omega \leq R < 19\text{ m}\Omega$
				± 1200	$19\text{ m}\Omega \leq R < 33\text{ m}\Omega$
				± 800	$33\text{ m}\Omega \leq R < 50\text{ m}\Omega$
				± 600	$50\text{ m}\Omega \leq R < 100\text{ m}\Omega$
				± 200	$100\text{ m}\Omega \leq R < 1000\text{ m}\Omega$
RTT06 (1206)	1/3W	5.77A	14.42A	± 1500	$10\text{ m}\Omega \leq R < 19\text{ m}\Omega$
				± 1200	$19\text{ m}\Omega \leq R < 25\text{ m}\Omega$
				± 1000	$25\text{ m}\Omega \leq R < 50\text{ m}\Omega$
				± 600	$50\text{ m}\Omega \leq R < 100\text{ m}\Omega$
				± 200	$100\text{ m}\Omega \leq R < 1000\text{ m}\Omega$
RTT12 (1210)	1/2W	7.07A	17.67A	± 1500	$10\text{ m}\Omega \leq R < 19\text{ m}\Omega$
				± 1000	$19\text{ m}\Omega \leq R < 25\text{ m}\Omega$
				± 700	$25\text{ m}\Omega \leq R < 50\text{ m}\Omega$
				± 400	$50\text{ m}\Omega \leq R < 100\text{ m}\Omega$
				± 200	$100\text{ m}\Omega \leq R < 1000\text{ m}\Omega$
RTT20 (2010)	3/4W	8.66A	21.65A	± 1500	$10\text{ m}\Omega \leq R < 19\text{ m}\Omega$
				± 1200	$19\text{ m}\Omega \leq R < 25\text{ m}\Omega$
				± 900	$25\text{ m}\Omega \leq R < 50\text{ m}\Omega$
				± 500	$50\text{ m}\Omega \leq R < 100\text{ m}\Omega$
				± 200	$100\text{ m}\Omega \leq R < 1000\text{ m}\Omega$
RTT25 (2512)	1 W	10A	25A	± 1500	$10\text{ m}\Omega \leq R < 19\text{ m}\Omega$
				± 1200	$19\text{ m}\Omega \leq R < 25\text{ m}\Omega$
				± 900	$25\text{ m}\Omega \leq R < 50\text{ m}\Omega$
				± 500	$50\text{ m}\Omega \leq R < 100\text{ m}\Omega$
				± 200	$100\text{ m}\Omega \leq R < 1000\text{ m}\Omega$
使用溫度範圍				-55°C ~ +155°C	

3.3 功率衰减曲线:

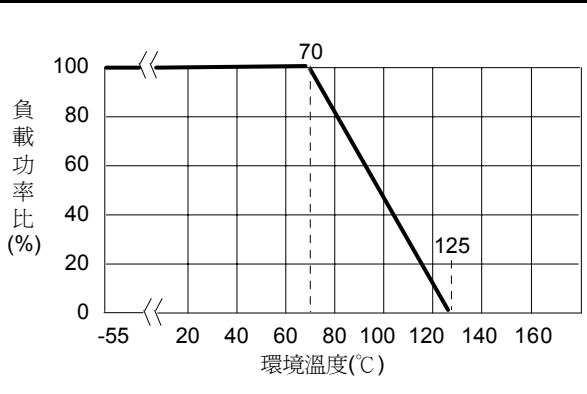
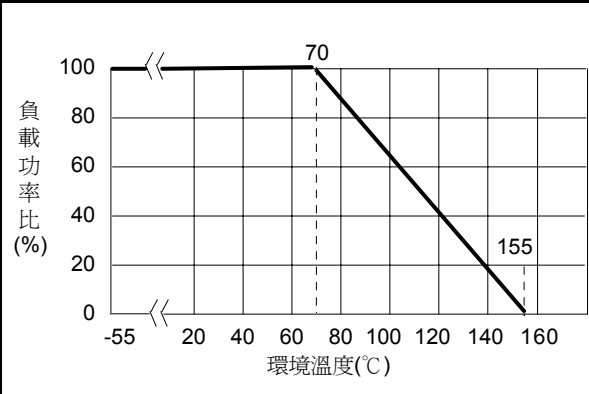
型別	RTT01 (0201)	其它
使用溫度範圍	-55°C ~ +125°C	-55°C ~ +155°C
說明	周圍溫度若超過70°C至125°C之間，功率可照下圖曲線予以修定之。	周圍溫度若超過70°C至155°C之間，功率可照下圖曲線予以修定之。
功率衰减曲线圖		

3.4 額定電壓或額定電流:

3.4.1 阻值範圍: $\geq 1\Omega$

額定電壓:對於額定功率之直流或交流(商用週率有效值rms.)電壓。

可用下列公式求得，但求得之值若超過規格表內之最高電壓時，則以最高額定電壓為其額定電壓。

$$E = \sqrt{R \times P}$$

E=額定電壓(V)

P=額定功率(W)

R=公稱阻值(Ω)

3.4.2 阻值範圍: $< 1\Omega$

額定電流:對於額定功率之直流或交流(商用週率有效值rms.)電流。

可用下列公式求得，但求得之值若超過規格表內之最高電流時，則以最高額定電流為其額定電流。

$$I = \sqrt{P/R}$$

I = 額定電流(A)

P=額定功率(W)

R=公稱阻值(Ω)

4 尺寸:

4.1 阻值範圍: $\geq 1\Omega$ & 0Ω

Unit : mm

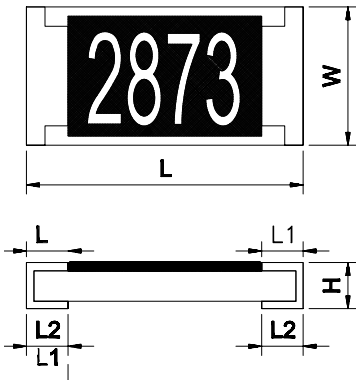

Dimension		L	W	H	L1	L2
TYPE	Size Code					
RTT01	0201	0.60± 0.03	0.30± 0.03	0.23± 0.03	0.15± 0.05	0.15± 0.05
RTT02	0402	1.00± 0.10	0.50± 0.05	0.30± 0.05	0.20± 0.10	0.25± 0.10
RTT03	0603	1.60± 0.10	0.80± 0.10	0.45± 0.10	0.30± 0.15	0.30± 0.15
RTT05	0805	2.00± 0.10	1.25± 0.10	0.50± 0.10	0.35± 0.20	0.35± 0.15
RTT06	1206	3.05± 0.10	1.55± 0.10	0.50± 0.10	0.45± 0.20	0.35± 0.15
RTT12	1210	3.05± 0.10	2.55± 0.10	0.55± 0.10	0.50± 0.20	0.50± 0.20
RTT20	2010	5.00± 0.20	2.50± 0.20	0.55± 0.10	0.60± 0.20	0.60± 0.20
RTT25	2512	6.30± 0.20	3.20± 0.20	0.55± 0.10	0.60± 0.20	0.60± 0.20

4.2 阻值範圍: $< 1\Omega$

Unit : mm

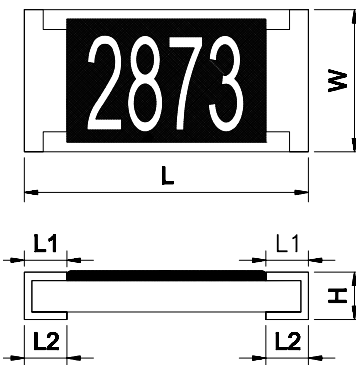

Dimensions		L	W	H	L1	L2
TYPE	Size Code					
RTT02	0402	1.00± 0.10	0.50± 0.05	0.35± 0.10	0.25± 0.10	0.20± 0.15
RTT03	0603	1.60± 0.10	0.80± 0.10	0.45± 0.10	0.25± 0.15	0.35± 0.15
RTT05	0805	2.00± 0.10	1.25± 0.10	0.50± 0.10	0.35± 0.20	0.35± 0.20
RTT06	1206	3.05± 0.10	1.55± 0.10	0.50± 0.10	0.45± 0.20	0.65± 0.15
RTT12	1210	3.05± 0.10	2.55± 0.10	0.55± 0.10	0.50± 0.20	0.50± 0.20
RTT20	2010	5.00± 0.20	2.50± 0.20	0.60± 0.10	0.65± 0.20	0.65± 0.20
RTT25	2512	6.30± 0.20	3.20± 0.20	0.60± 0.10	0.65± 0.20	0.65± 0.20

5 結構圖:

5.1 阻值範圍: $\geq 1\Omega$ & $0\ \Omega$

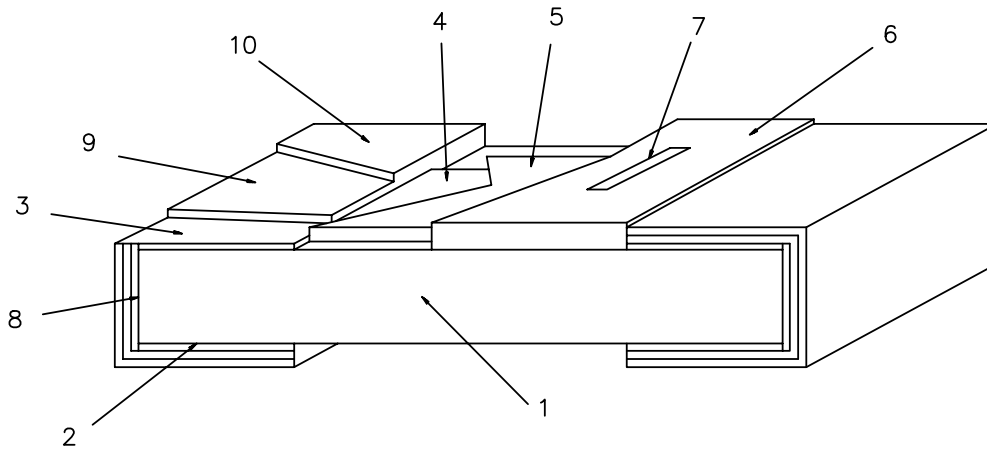

1	陶瓷基板	Ceramic substrate	6	2nd 保護層	2nd Protective coating
2	背面內部電極	Bottom inner electrode	7	字碼	Marking
3	正面內部電極	Top inner electrode	8	側面內部電極	Terminal inner electrode
4	電阻層	Resistive layer	9	Ni 層電鍍	Ni plating
5	1st 保護層	1st Protective coating	10	Sn 層電鍍	Sn plating

5.2 阻值範圍:<1Ω

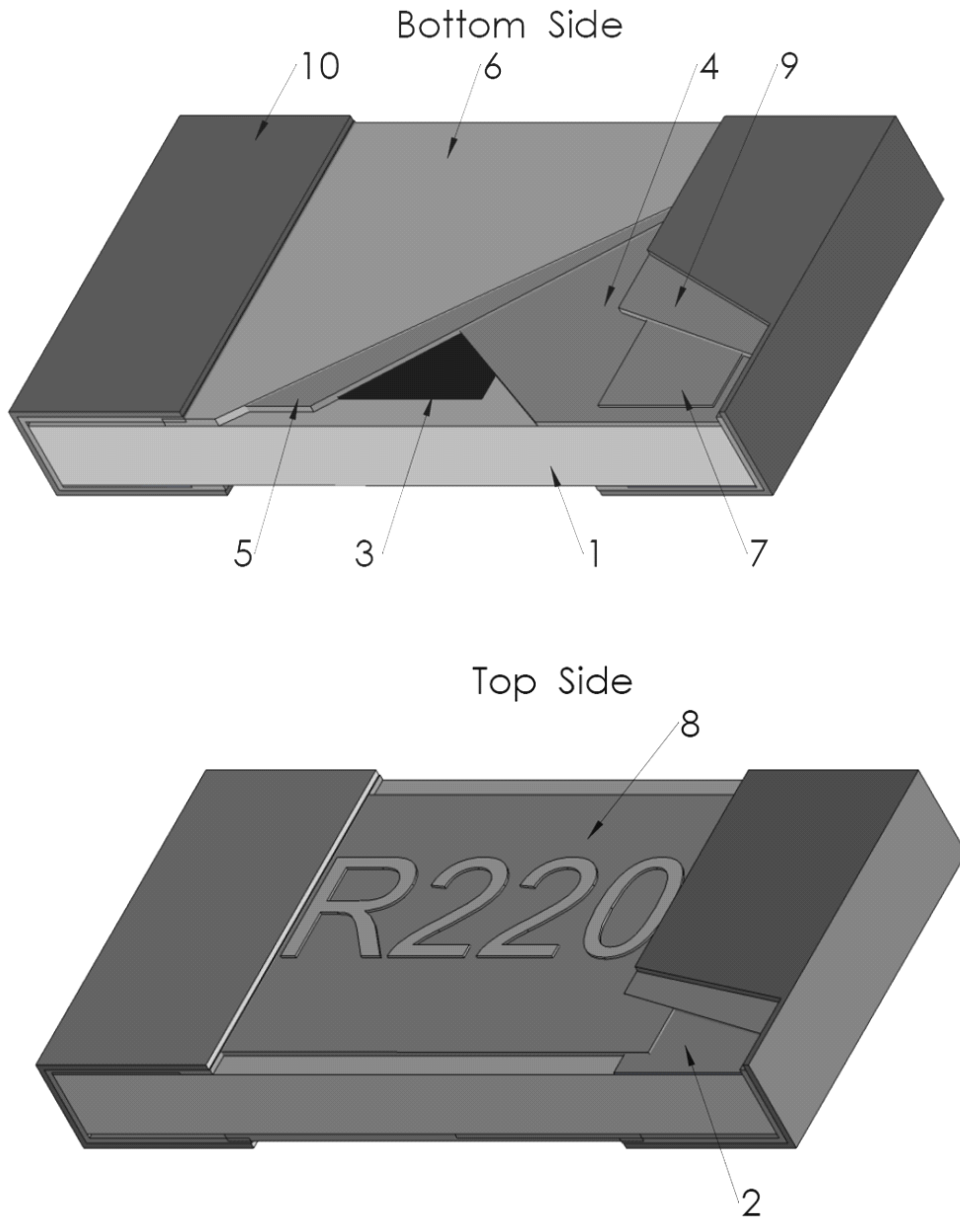

1	陶瓷基板	Ceramic substrate	6	2nd保護層	2nd Protective coating
2	正面內部電極	Top inner electrode	7	C3層	C3 layer
3	電阻層	Resistive layer	8	G2+MK層	G2 layer+Marking
4	背面內部電極	Bottom inner electrode	9	Ni層電鍍	Ni plating
5	1st保護層	1st Protective coating	10	Sn層電鍍	Sn plating

6 信賴性試驗項目:

6.1 電氣性能試驗(Electrical Performance Test)

ITEM 項目	Conditions 條件	Specifications規格																												
		Resistors	Jumper																											
Temperature Coefficient of Resistance 溫度係數	$TCR \text{ (ppm / } ^\circ\text{C)} = \frac{(R2 - R1)}{R1 (T2 - T1)} \times 10^6$ R1:室溫下量測之阻值(Ω) R2:-55 $^\circ\text{C}$ 或+125 $^\circ\text{C}$ 下量測之阻值(Ω) T1:室溫之溫度($^\circ\text{C}$) T2:-55 $^\circ\text{C}$ 或+125 $^\circ\text{C}$ 之溫度($^\circ\text{C}$)。 依據 JIS-C5201-1 4.8	參考3.規格表	NA																											
Short Time Overload 短時間過負荷	施加2.5倍的額定電壓5秒，靜置30分鐘以上再量測阻值變化率。(額定電壓值請參考 3.規格表) Jumper:施加最高過負荷電流: <table border="1" style="margin-top: 10px;"> <thead> <tr> <th>型別 Jumper 額定電流</th> <th>RTT01 (0201)</th> <th>RTT02 (0402)</th> <th>RTT03 (0603)</th> <th>RTT05 (0805)</th> <th>RTT06 (1206)</th> <th>RTT12 (1210)</th> <th>RTT20 (2010)</th> <th>RTT25 (2512)</th> </tr> </thead> <tbody> <tr> <td>$\pm 5\%$</td> <td>1.25A</td> <td>2.5A</td> <td>2.5A</td> <td>5A</td> <td>5A</td> <td>5A</td> <td>5A</td> <td>5A</td> </tr> <tr> <td>$\pm 1\%$</td> <td>1.25A</td> <td>3.75A</td> <td>5A</td> <td>6.25A</td> <td>8.75A</td> <td>10A</td> <td>12.5A</td> <td>17.5A</td> </tr> </tbody> </table> 依據 JIS-C5201-1 4.13	型別 Jumper 額定電流	RTT01 (0201)	RTT02 (0402)	RTT03 (0603)	RTT05 (0805)	RTT06 (1206)	RTT12 (1210)	RTT20 (2010)	RTT25 (2512)	$\pm 5\%$	1.25A	2.5A	2.5A	5A	5A	5A	5A	5A	$\pm 1\%$	1.25A	3.75A	5A	6.25A	8.75A	10A	12.5A	17.5A	1.阻值範圍: $\geq 1\Omega$ 0.1%、0.5%、1% \pm (1.0%+0.05 Ω) 2%、5% \pm (2.0%+0.10 Ω) 2.阻值範圍: $< 1\Omega$ 1%、2%、5% \pm (2.0%+0.001 Ω) 外觀無損傷，無短路或燒毀現象。	參考3.規格表
型別 Jumper 額定電流	RTT01 (0201)	RTT02 (0402)	RTT03 (0603)	RTT05 (0805)	RTT06 (1206)	RTT12 (1210)	RTT20 (2010)	RTT25 (2512)																						
$\pm 5\%$	1.25A	2.5A	2.5A	5A	5A	5A	5A	5A																						
$\pm 1\%$	1.25A	3.75A	5A	6.25A	8.75A	10A	12.5A	17.5A																						
Insulation Resistance 絕緣電阻試驗	將晶片電阻置於治具上，在正負極施加100 VDC一分鐘後測量電極與保護層及電極與基板(底材)之絕緣電阻值。 依據 JIS-C5201-1 4.6 	$\geq 10^9 \Omega$																												
Dielectric Withstand Voltage 絕緣耐電壓	將晶片電阻置於治具上，在正、負極施加VAC (參考下列) RTT05、06、12、20、25 用500 VAC一分鐘 RTT01、02、03用300 VAC一分鐘 依據 JIS-C5201-1 4.7	無短路或燒毀現象。																												
Intermittent Overload 斷續過負荷	置於恆溫箱中，施加2.5倍額定電壓，1秒ON，25秒OFF，計 $10,000^{+400}_{-0}$ 次取出靜置60分鐘後量測阻值變化量。 Jumper:施加最高過負荷電流: <table border="1" style="margin-top: 10px;"> <thead> <tr> <th>型別 Jumper 額定電流</th> <th>RTT01 (0201)</th> <th>RTT02 (0402)</th> <th>RTT03 (0603)</th> <th>RTT05 (0805)</th> <th>RTT06 (1206)</th> <th>RTT12 (1210)</th> <th>RTT20 (2010)</th> <th>RTT25 (2512)</th> </tr> </thead> <tbody> <tr> <td>$\pm 5\%$</td> <td>1.25A</td> <td>2.5A</td> <td>2.5A</td> <td>5A</td> <td>5A</td> <td>5A</td> <td>5A</td> <td>5A</td> </tr> <tr> <td>$\pm 1\%$</td> <td>1.25A</td> <td>3.75A</td> <td>5A</td> <td>6.25A</td> <td>8.75A</td> <td>10A</td> <td>12.5A</td> <td>17.5A</td> </tr> </tbody> </table> 依據 JIS-C5201-1 4.13	型別 Jumper 額定電流	RTT01 (0201)	RTT02 (0402)	RTT03 (0603)	RTT05 (0805)	RTT06 (1206)	RTT12 (1210)	RTT20 (2010)	RTT25 (2512)	$\pm 5\%$	1.25A	2.5A	2.5A	5A	5A	5A	5A	5A	$\pm 1\%$	1.25A	3.75A	5A	6.25A	8.75A	10A	12.5A	17.5A	1.阻值範圍: $\geq 1\Omega$ $\pm (5.0\% + 0.10\Omega)$ 2.阻值範圍: $< 1\Omega$ $\pm (5.0\% + 0.001\Omega)$	參考3.規格表
型別 Jumper 額定電流	RTT01 (0201)	RTT02 (0402)	RTT03 (0603)	RTT05 (0805)	RTT06 (1206)	RTT12 (1210)	RTT20 (2010)	RTT25 (2512)																						
$\pm 5\%$	1.25A	2.5A	2.5A	5A	5A	5A	5A	5A																						
$\pm 1\%$	1.25A	3.75A	5A	6.25A	8.75A	10A	12.5A	17.5A																						
Noise Level 雜音測驗	依據 JIS-C5201-1 4.12 測試方法。	<table border="1"> <thead> <tr> <th>電阻(Resistance)</th> <th>雜音(Noise)</th> </tr> </thead> <tbody> <tr> <td>$R < 100\Omega$</td> <td>$\leq -10\text{db}(0.32 \mu\text{V/V})$</td> </tr> <tr> <td>$100\Omega \leq R < 1\text{K}\Omega$</td> <td>$\leq 0\text{db}(1.0 \mu\text{V/V})$</td> </tr> <tr> <td>$1\text{K}\Omega \leq R < 10\text{K}\Omega$</td> <td>$\leq 10\text{db}(3.2 \mu\text{V/V})$</td> </tr> <tr> <td>$10\text{K}\Omega \leq R < 100\text{K}\Omega$</td> <td>$\leq 15\text{db}(5.6 \mu\text{V/V})$</td> </tr> <tr> <td>$100\text{K}\Omega \leq R < 1\text{M}\Omega$</td> <td>$\leq 20\text{db}(10 \mu\text{V/V})$</td> </tr> <tr> <td>$1\text{M}\Omega \leq R$</td> <td>$\leq 30\text{db}(32 \mu\text{V/V})$</td> </tr> </tbody> </table>	電阻(Resistance)	雜音(Noise)	$R < 100\Omega$	$\leq -10\text{db}(0.32 \mu\text{V/V})$	$100\Omega \leq R < 1\text{K}\Omega$	$\leq 0\text{db}(1.0 \mu\text{V/V})$	$1\text{K}\Omega \leq R < 10\text{K}\Omega$	$\leq 10\text{db}(3.2 \mu\text{V/V})$	$10\text{K}\Omega \leq R < 100\text{K}\Omega$	$\leq 15\text{db}(5.6 \mu\text{V/V})$	$100\text{K}\Omega \leq R < 1\text{M}\Omega$	$\leq 20\text{db}(10 \mu\text{V/V})$	$1\text{M}\Omega \leq R$	$\leq 30\text{db}(32 \mu\text{V/V})$	NA													
電阻(Resistance)	雜音(Noise)																													
$R < 100\Omega$	$\leq -10\text{db}(0.32 \mu\text{V/V})$																													
$100\Omega \leq R < 1\text{K}\Omega$	$\leq 0\text{db}(1.0 \mu\text{V/V})$																													
$1\text{K}\Omega \leq R < 10\text{K}\Omega$	$\leq 10\text{db}(3.2 \mu\text{V/V})$																													
$10\text{K}\Omega \leq R < 100\text{K}\Omega$	$\leq 15\text{db}(5.6 \mu\text{V/V})$																													
$100\text{K}\Omega \leq R < 1\text{M}\Omega$	$\leq 20\text{db}(10 \mu\text{V/V})$																													
$1\text{M}\Omega \leq R$	$\leq 30\text{db}(32 \mu\text{V/V})$																													

6.2 機械性能試驗(Mechanical Performance Test)

ITEM 項目	Conditions 條件	Specifications規格							
		Resistors	Jumper						
Core body strength 本體強度	使用R0.5的測試探針在本體中央向下施加10N { 1.02 kgf } 的負載持續10 sec。 1.RTT02、RTT03測試探針R0.2 2.RTT05、06、12、20、25測試探針R0.5 依據 JIS-C5201-1 4.15	1.阻值範圍: $\geq 1\Omega$ $\pm (1.0\%+0.05\Omega)$ 2.阻值範圍: $< 1\Omega$ $\pm (1.0\%+0.001\Omega)$	參考3.規格表						
Terminal Strength 端電極拉力測試	測試項目一:將電阻焊在電路板上,在電阻背面施以5N的力量持續10 sec後,檢查側導體外觀。(RTT01:3N) 測試項目二:將電阻焊在電路板上,逐漸施加力量於電阻背面,測試端電極最大剝離強度。 依據 JIS-C5201-1 4.16	項目一:外觀無損傷,無側導脫落及本體斷裂發生。 項目二:RTT01 $\geq 3N$ 其它 $\geq 5N$							
Resistance to Solvent 耐溶劑性試驗	浸於20~25°C異丙醇溶劑中5 \pm 0.5分鐘後,取出靜置48 hr以上,再量測阻值變化率。 依據 JIS-C5201-1 4.29	1.阻值範圍: $\geq 1\Omega$ <table border="1" style="margin-left: 20px;"> <tr> <td>型別</td> <td>RTT01</td> <td>其它</td> </tr> <tr> <td>$\Delta R\%$</td> <td>$\pm (1.0\%+0.05\Omega)$</td> <td>$\pm (0.5\%+0.05\Omega)$</td> </tr> </table> 2.阻值範圍: $< 1\Omega$ $\pm (1.0\%+0.001\Omega)$	型別	RTT01	其它	$\Delta R\%$	$\pm (1.0\%+0.05\Omega)$	$\pm (0.5\%+0.05\Omega)$	參考3.規格表
型別	RTT01	其它							
$\Delta R\%$	$\pm (1.0\%+0.05\Omega)$	$\pm (0.5\%+0.05\Omega)$							
Solderability 焊錫性	前處理 將晶片電阻放置於PCT試驗機內,在溫度105°C、濕度100%及氣壓 1.22×10^5 pa的飽和條件下進行4小時的老化測試,取出後靜置於室溫下2小時。 測試方法: 將電阻浸於235 ± 3 °C之爐中2 ± 0.5 秒後取出置於顯微鏡下觀察焊錫面積。 依據 JIS-C5201-1 4.17	導體吃錫面積應大於95%。							
Resistance to soldering heat 抗焊錫熱	◎測試項目一(焊錫爐測試): 浸於260 ± 5 /-0°C之錫爐中10秒 ± 1 /-0,取出靜置60分鐘以上,再量測阻值變化率。 ◎測試項目二(焊錫爐測試) 浸於260 ± 5 /-0°C之錫爐中30 ± 1 /-0秒,取出後洗淨。置於顯微鏡下觀察焊錫面積。 ◎測試項目三(電烙鐵試驗): 加熱溫度:350 ± 10 °C 電烙鐵加熱時間:3 ± 1 /-0 sec。 取電烙鐵加熱於電極兩端後,取出靜置60分鐘以上,再量測阻值變化率。 依據 JIS-C5201-1 4.18	試驗項目一: (一).阻值變化率 1.阻值範圍: $\geq 1\Omega$ $\Delta R\% = \pm (1.0\%+0.05\Omega)$ 2.阻值範圍: $< 1\Omega$ $\Delta R\% = \pm (1.0\%+0.001\Omega)$ (二).電極外觀無異常,無側導脫落。 試驗項目二: (一).導體吃錫面積應大於95%。 (二).在電極邊緣處不應見到下層的物质(例如白基板)。 試驗項目三: (一).阻值變化率 1.阻值範圍: $\geq 1\Omega$ $\Delta R\% = \pm (1.0\%+0.05\Omega)$ 2.阻值範圍: $< 1\Omega$ $\Delta R\% = \pm (1.0\%+0.001\Omega)$ (二).電極外觀無異常,無側導脫落。	參考3.規格表						

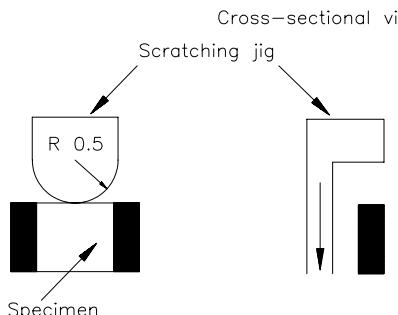
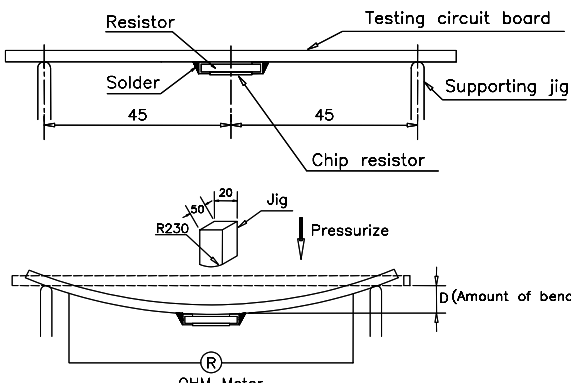
ITEM 項目	Conditions 條件	Specifications規格	
		Resistors	Jumper
Joint Strength of Solder 焊錫粘合強度	<p>前處理 將晶片電阻放置於PCT試驗機內，在溫度105°C、濕度100%及氣壓1.22×10^5 pa的飽和條件下進行4小時的老化測試，取出後靜置於室溫下2小時。</p> <p>◎測試項目一(固著性測試): 將晶片電阻焊於固著性測試板中，置於端電極測試機上，以半徑R0.5 (O201:R0.1)之測試探針朝施力方向施加力量，並保持10 sec，於負荷下量測阻值變化率。 力量：1.RTT02=10N 2.其它型別=20N 3.RTT01:5N</p>  <p>依據JIS-C5201-1 4.32</p> <p>◎測試項目二(彎折性測試): 將晶片電阻焊於彎折性測試板中，置於彎折測試機上，在測試板中央施力下壓，於負荷下量測阻值變化率。 下壓深度(D):RTT02、03、05=5mm RTT01、06、12=3mm RTT20、25=2mm</p>  <p>依據JIS-C5201-1 4.33</p>	<p>試驗項目一: (一).阻值變化率 1.阻值範圍:$\geq 1 \Omega$ $\Delta R\% = \pm (1.0\% + 0.05\Omega)$ 2.阻值範圍:$< 1 \Omega$ $\Delta R\% = \pm (1.0\% + 0.001\Omega)$ (二).外觀無損傷、無側導脫落。</p> <p>試驗項目二: (一).阻值變化率 1.阻值範圍:$\geq 1 \Omega$ $\Delta R\% = \pm (1.0\% + 0.05\Omega)$ 2.阻值範圍:$< 1 \Omega$ $\Delta R\% = \pm (1.0\% + 0.001\Omega)$ (二).外觀無損傷、無側導脫落及本體斷裂發生。</p>	參考3.規格表
Vibration 耐振性試驗	<p>將晶片電阻焊於測試板上施加一振動波 震動頻率:10 Hz ~ 55 Hz ~ 10 Hz/分 振幅:1.5 mm 測試時間:6 hr (X.Y.Z3個方向各2 hr) 依據 JIS-C5201-1 4.22</p>	<p>1.阻值範圍:$\geq 1 \Omega$ 0.1%、0.5%、1%:$\pm (0.5\% + 0.05\Omega)$ 2%、5%:$\pm (1.0\% + 0.05\Omega)$ 2.阻值範圍:$< 1 \Omega$ 1%、2%、5%:$\pm (1.0\% + 0.001\Omega)$</p>	參考3.規格表
		外觀無損傷	

6.3 環境試驗(Environmental Test)

ITEM 項目	Conditions 條件	Specifications規格									
		Resistors	Jumper								
Resistance to Dry Heat 耐熱性試驗	置於155± 5°C之烤箱中1000+48/-0 hr，取出靜置1 hr以上再量測阻值變化率。 PS:RTT01置於125± 3°C中。 依據 JIS-C5201-1 4.25	1.阻值範圍:≥1Ω 0.1%、0.5%、1%:± (1.0%+0.05Ω) 2%、5%:± (2.0%+0.10Ω) 2.阻值範圍:<1Ω 1%、2%、5% :± (1.0%+0.001Ω)	參考3.規格表								
Thermal Shock 冷熱沖擊	將晶片電阻置入冷熱沖擊機中，溫度為-55°C 15分鐘，+125°C 15分鐘，共計循環300次後取出，靜置60分鐘再量測阻值變化率。 <table border="1" style="margin-left: 20px;"> <tr> <th colspan="2">測試條件</th> </tr> <tr> <td>最低溫度</td> <td>-55± 5°C</td> </tr> <tr> <td>最高溫度</td> <td>125± 5°C</td> </tr> <tr> <td>溫度保留時間</td> <td>15分鐘</td> </tr> </table> 依據 MIL-STD 202 Method 107	測試條件		最低溫度	-55± 5°C	最高溫度	125± 5°C	溫度保留時間	15分鐘	1.阻值範圍:≥1Ω 0.1%、0.5%、1%:± (0.5%+0.05Ω) 2%、5%:± (1.0%+0.05Ω) 2.阻值範圍:<1Ω 1%、2%、5% :± (1.0%+0.001Ω)	參考3.規格表
		測試條件									
最低溫度	-55± 5°C										
最高溫度	125± 5°C										
溫度保留時間	15分鐘										
Loading Life in Moisture 耐濕負荷	置於溫度40± 2°C相對濕度90~95%恆溫恆濕槽中，並施加額定電壓，90分鐘ON，30分鐘OFF，共1,000 hr取出靜置60分鐘以上再量測阻值變化率。 依據 JIS-C5201-1 4.24	1.阻值範圍:≥1Ω 2.阻值範圍:<1Ω 1%、2%、5% :± (2.0%+0.001Ω)	參考3.規格表								
		<table border="1" style="margin-left: 20px;"> <tr> <th>型別</th> <th>RTT01</th> <th>其它</th> </tr> <tr> <th>範圍</th> <td>1%:± (1.0%+0.05Ω) 5%:± (3.0%+0.1Ω)</td> <td>0.1%、0.5%、1%: ± (0.5%+0.05Ω) 2%、5%: ± (2.0%+0.10Ω)</td> </tr> </table>		型別	RTT01	其它	範圍	1%:± (1.0%+0.05Ω) 5%:± (3.0%+0.1Ω)	0.1%、0.5%、1%: ± (0.5%+0.05Ω) 2%、5%: ± (2.0%+0.10Ω)		
型別	RTT01	其它									
範圍	1%:± (1.0%+0.05Ω) 5%:± (3.0%+0.1Ω)	0.1%、0.5%、1%: ± (0.5%+0.05Ω) 2%、5%: ± (2.0%+0.10Ω)									
Load Life 負荷壽命	置於70± 2°C之烤箱中施加額定電壓，90分鐘ON，30分鐘OFF，共1,000 hr取出靜置60分鐘以上再量測阻值變化率。 依據 JIS-C5201-1 4.25	1.阻值範圍:≥1Ω 2.阻值範圍:<1Ω 1%、2%、5% :± (2.0%+0.001Ω)	參考3.規格表								
		<table border="1" style="margin-left: 20px;"> <tr> <th>型別</th> <th>RTT01</th> <th>其它</th> </tr> <tr> <th>範圍</th> <td>1%:± (1.0%+0.05Ω) 5%:± (3.0%+0.1Ω)</td> <td>0.1%、0.5%、1%: ± (0.5%+0.05Ω) 2%、5%: ± (2.0%+0.10Ω)</td> </tr> </table>		型別	RTT01	其它	範圍	1%:± (1.0%+0.05Ω) 5%:± (3.0%+0.1Ω)	0.1%、0.5%、1%: ± (0.5%+0.05Ω) 2%、5%: ± (2.0%+0.10Ω)		
型別	RTT01	其它									
範圍	1%:± (1.0%+0.05Ω) 5%:± (3.0%+0.1Ω)	0.1%、0.5%、1%: ± (0.5%+0.05Ω) 2%、5%: ± (2.0%+0.10Ω)									
Low Temperature Operation 低溫操作	將晶片電阻放置-55°C恆溫箱中60分鐘，施加額定電壓45分鐘，停止施壓15分鐘取出後靜置8± 1 hr再量測阻值變化率。 依據MIL-R-55342D 4.7.4	1.阻值範圍:≥1Ω 0.1%、0.5%、1%:± (0.5%+0.05Ω) 2%、5%:± (1.0%+0.05Ω) 2.阻值範圍:<1Ω 1%、2%、5% :± (1.0%+0.001Ω)	參考3.規格表								
Whisker試驗	◎測試項目(冷熱衝擊測試): 將晶片電阻置放於冷熱衝擊試驗箱內，並依下列條件做測試，試驗後置於室溫下2小時。 Table 1溫度循環測試條件 <table border="1" style="margin-left: 20px;"> <tr> <td>最低儲存溫度</td> <td>-55+0/-10°C</td> </tr> <tr> <td>最高儲存溫度</td> <td>85+10/-0°C</td> </tr> <tr> <td>溫度保留時間</td> <td>10分</td> </tr> <tr> <td>溫度循環次數</td> <td>1,500</td> </tr> </table> ◎檢查 將放大鏡的倍數調至40或大於40的倍數下做視察和測試，如果此方法難做出判斷，我們可以改用掃描電子顯微鏡(SEM)，且將倍數調至1000或大於1000倍數下做視察和測試。 依據JEDEC Standard NO.22A121 class2.	最低儲存溫度	-55+0/-10°C	最高儲存溫度	85+10/-0°C	溫度保留時間	10分	溫度循環次數	1,500	Whisker長度在50 μm之內。	
最低儲存溫度	-55+0/-10°C										
最高儲存溫度	85+10/-0°C										
溫度保留時間	10分										
溫度循環次數	1,500										

7 建議焊錫條件:

7.1 Free IR Reflow Soldering Profile

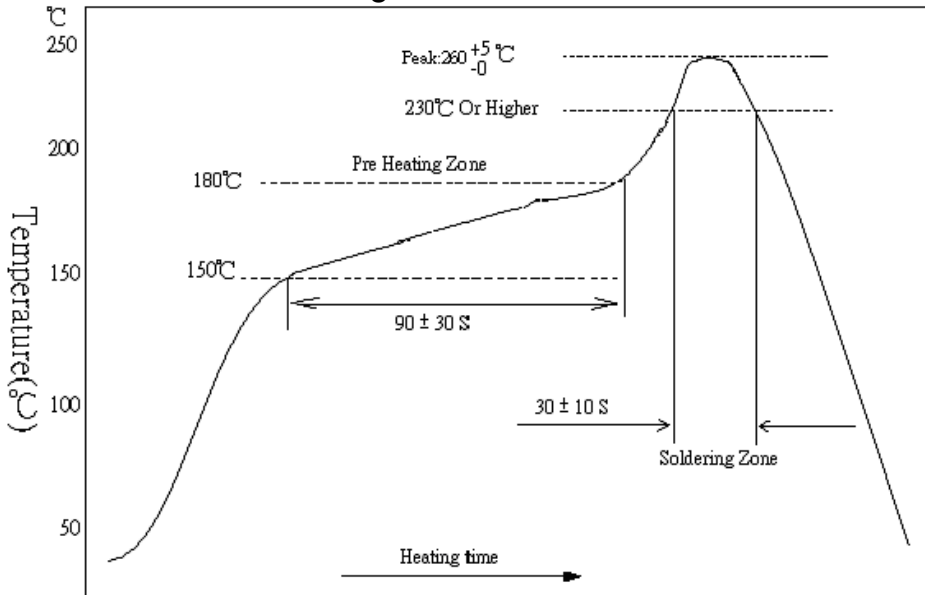

備註:零件最高耐溫 260^{+5}_{-0} °C,10秒。

7.2 Lead Free Double-Wave Soldering Profile(適用0603(含)以上之產品)

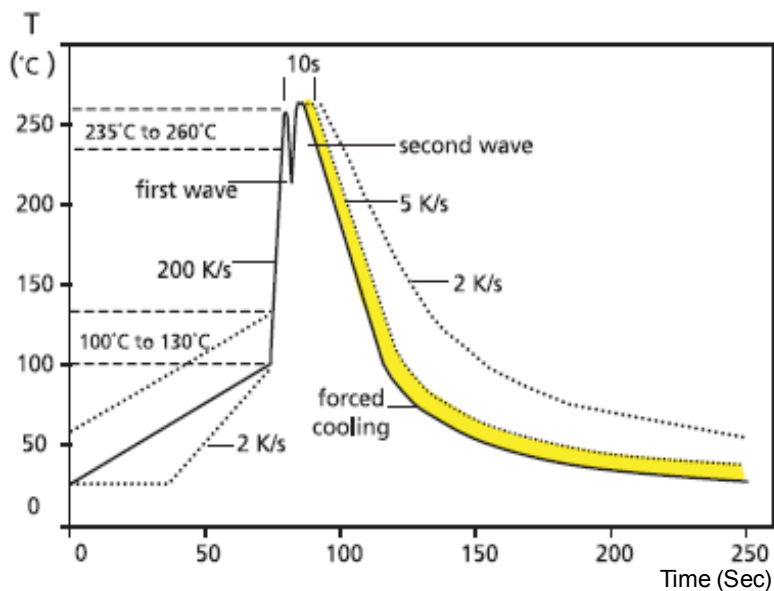

7.3 烙鐵焊錫方法: 350 ± 10 °C 3秒之內。

8 建議 Land Pattern Design (For Reflow Soldering) :

Unit : mm

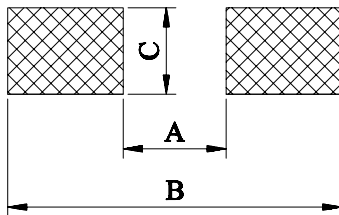

DIM TYPE	A	B	C
RTT01	0.3	1.0	0.4
RTT02	0.5	1.5	0.6
RTT03	0.8	2.1	0.9
RTT05	1.2	3.0	1.3
RTT06	2.2	4.2	1.6
RTT12	2.2	4.2	2.8
RTT20	3.5	6.1	2.8
RTT25	3.8	8.0	3.5

9 字碼表示法:

9.1 阻值範圍: $\geq 1\Omega$

9.1.1 RTT03、05、06、12、20、25 $\pm 2\%$ 、 $\pm 5\%$ 容差:

9.1.1.1 阻值 $\geq 10\Omega$:以E-24系列三位數字表示，前二位數為有效數字，第三位數為乘冪(10^x)。

《例》字碼→100
 $100=10 \times 10^0=10\Omega$

9.1.1.2 阻值 $< 10\Omega$:以E-24系列三位數字表示，第一、三位數為有效數字，第二位數為乘冪(10^{-1})。

《例》字碼→4R7
 $4R7=47 \times 10^{-1}=4.7\Omega$

9.1.2 RTT05、06、12、20、25 $\pm 0.1\%$ 、 $\pm 0.5\%$ 、 $\pm 1\%$ 容差:

9.1.2.1 阻值 $\geq 100\Omega$:以E-24、E-96系列四位數字表示，前三位數為有效數字，第四位數為乘冪(10^x)。

《例》字碼→1002
 $1002=100 \times 10^2=10000\Omega=10K\Omega$

9.1.2.2 阻值 $< 100\Omega$:以E-24、E-96系列四位數字表示，其中三位數為有效數字，R為乘冪(10^x)。

《例》字碼→10R2 R為乘冪(10^{-1})
 $10R2=102 \times 10^{-1}=10.2\Omega$
 字碼→1R02 R為乘冪(10^{-2})
 $1R02=102 \times 10^{-2}=1.02\Omega$

9.1.3 RTT03 ± 0.1%、± 0.5%、± 1%容差(特殊):

以E-96系列表示，不使用四字碼而使用EIAJ如下表之代碼。
前二位數為代碼，第三位數為乘冪(10^x)。

《例》字碼→47B

$$47B = 301 \times 10^1 = 3010 \Omega = 3.01K\Omega$$

若阻值未在E-96系列而在E24系列內，則以E-24系列三字碼且底下加一橫槓表示。

阻值 $\geq 100\Omega$: 字碼 391 $39\bar{1} = 39 \times 10^1 = 390\Omega$

阻值 $< 100\Omega$: 字碼 390 $39\bar{0} = 39 \times 10^0 = 39\Omega$

9.2 阻值範圍: $< 1\Omega$

9.2.1 RTT03、05、06、12、20、25 ± 1%、± 2%、± 5%容差:

9.2.1.1 阻值 $\geq 100\text{ m}\Omega$: 以E-24、E-96系列四位數字表示，後三位數為有效數字，第一位數為乘冪(10^{-3})。

《例》字碼→R220 (E-24系列)

$$R220 = 220 \times 10^{-3} = 0.22 \Omega = 220 \text{ m}\Omega$$

字碼→R102 (E-96系列)

$$R102 = 102 \times 10^{-3} = 0.102 \Omega = 102 \text{ m}\Omega$$

9.2.1.2 阻值 $< 100\text{ m}\Omega$: 以E-24系列四位數字表示，後二位數為有效數字，第一位數為乘冪(10^{-3})。

《例》字碼→R022

$$R022 = 22 \times 10^{-3} = 0.022 \Omega = 22 \text{ m}\Omega$$

9.3 RTT 0R:

9.3.1 RTT03、05、06、12、20、25± 1%容差：產品以三字碼"000"表示。

9.3.2 RTT03、05、06、12、20、25± 5%容差：產品以一字碼"0"表示。

9.4 RTT01、RTT02 無字碼表示

9.5 字碼表

9.5.1 E-24 系列

10	11	12	13	15	16	18	20	22	24	27	30
33	36	39	43	47	51	56	62	68	75	82	91

9.5.2 E-96 系列







































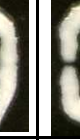





















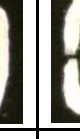

100	102	105	107	110	113	115	118	121	124	127	130
133	137	140	143	147	150	154	158	162	165	169	174
178	182	187	191	196	200	205	210	215	221	226	232
237	243	249	255	261	267	274	280	287	294	301	309
316	324	332	340	348	357	365	374	383	392	402	412
422	432	442	453	464	475	487	499	511	523	536	549
562	576	590	604	619	634	649	665	681	698	715	732
750	768	787	806	825	845	866	887	909	931	953	976

9.5.3 EIAJ 代碼表:

代碼	阻值	代碼	阻值	代碼	阻值	代碼	阻值	代碼	阻值	代碼	阻值	代碼	阻值	代碼	阻值
01	100	13	133	25	178	37	237	49	316	61	422	73	562	85	750
02	102	14	137	26	182	38	243	50	324	62	432	74	576	86	768
03	105	15	140	27	187	39	249	51	332	63	442	75	590	87	787
04	107	16	143	28	191	40	255	52	340	64	453	76	604	88	806
05	110	17	147	29	196	41	261	53	348	65	464	77	619	89	825
06	113	18	150	30	200	42	267	54	357	66	475	78	634	90	845
07	115	19	154	31	205	43	274	55	365	67	487	79	649	91	866
08	118	20	158	32	210	44	280	56	374	68	499	80	665	92	887
09	121	21	162	33	215	45	287	57	383	69	511	81	681	93	909
10	124	22	165	34	221	46	294	58	392	70	523	82	698	94	931
11	127	23	169	35	226	47	301	59	402	71	536	83	715	95	953
12	130	24	174	36	232	48	309	60	412	72	549	84	732	96	976

$$Y=10^{-2} \quad X=10^{-1} \quad A=10^0 \quad B=10^1 \quad C=10^2 \quad D=10^3 \quad E=10^4 \quad F=10^5$$

9.6 標準字碼外觀一覽表

Making Type	A	B	C	D	E	F	X	Y			
0603											
Making Type	1	2	3	4	5	6	7	8	9	0	R
0603											
0805											
1206											
1210											
2010 2512											

10 鍍層厚度:

10.1 鍍層厚度: $\geq 1 \mu m$

10.2 純錫: $\geq 3 \mu m$

10.3 電鍍純錫為霧錫

11 包装:

11.1 承载带尺寸 (Tape Dimensions):

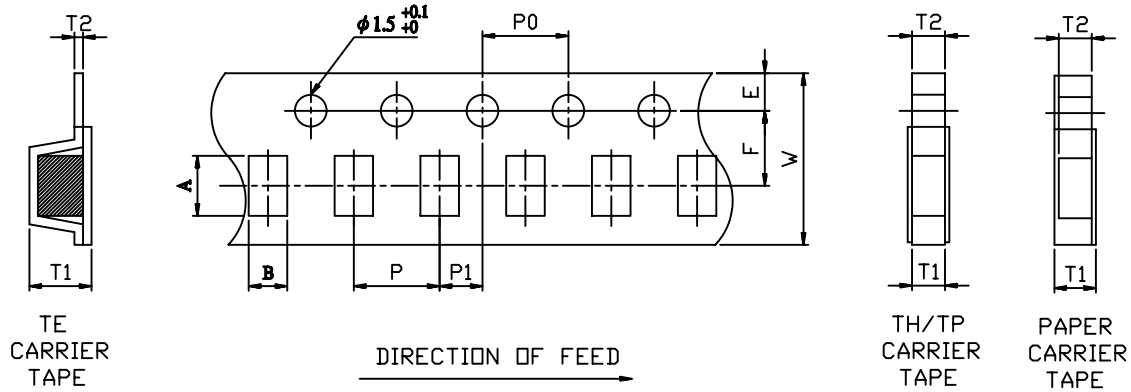

Unit : mm

Packaging	DIM TYPE	A	B	W	E	F	T1	T2	P	P0	10x P0	P1
TH Carrier Tape	RTT01	0.68± 0.03	0.38± 0.03	8.0± 0.1	1.75± 0.1	3.5± 0.05	0.45+0.1/-0	0.28± 0.02	2.0± 0.05	4.0± 0.05	40.0± 0.20	2.0± 0.05
	RTT02	1.15± 0.05	0.65± 0.05	8.0± 0.2	1.75± 0.1	3.5± 0.05	0.45+0.2/-0	0.45± 0.05	2.0± 0.1	4.0± 0.05	40.0± 0.2	2.0± 0.05
TP Carrier Tape	RTT03	1.80± 0.1	1.00± 0.1	8.0± 0.2	1.75± 0.1	3.5± 0.05	0.60+0.2/-0	0.60± 0.1	4.0± 0.1	4.0± 0.05	40.0± 0.20	2.0± 0.05
	RTT05	2.30± 0.1	1.55± 0.1	8.0± 0.2	1.75± 0.1	3.5± 0.05	0.75+0.2/-0	0.75± 0.1	4.0± 0.1	4.0± 0.05	40.0± 0.20	2.0± 0.05
	RTT06	3.50± 0.2	1.90± 0.2	8.0± 0.2	1.75± 0.1	3.5± 0.05	0.75+0.2/-0	0.75± 0.1	4.0± 0.1	4.0± 0.05	40.0± 0.20	2.0± 0.05
	RTT12	3.50± 0.2	2.80± 0.2	8.0± 0.2	1.75± 0.1	3.5± 0.05	0.75+0.2/-0	0.75± 0.1	4.0± 0.1	4.0± 0.05	40.0± 0.20	2.0± 0.05
TE Carrier Tape	RTT20	5.50± 0.2	2.80± 0.2	12.0± 0.2	1.75± 0.1	5.5± 0.05	0.85± 0.15	0.23± 0.15	4.0± 0.1	4.0± 0.05	40.0± 0.20	2.0± 0.05
	RTT25	6.70± 0.2	3.40± 0.2	12.0± 0.2	1.75± 0.1	5.5± 0.05	0.85± 0.15	0.23± 0.15	4.0± 0.1	4.0± 0.05	40.0± 0.20	2.0± 0.05

11.2 前、后导带尺寸 (Lead Dimensions) :

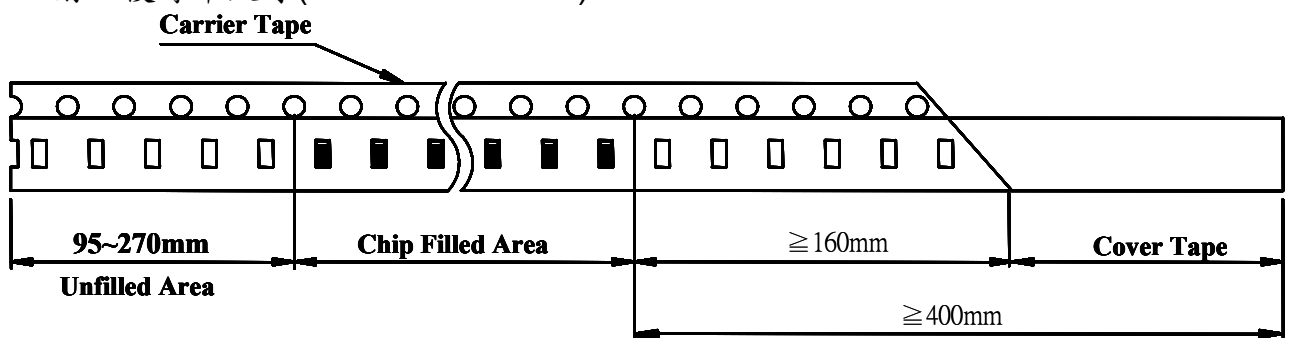

11.3 上膠帶剝離力量 (Peel off Strength):

規格值: 0201、0402 => 0.07 ~ 0.5N (7.1 ~ 51 gf)

0603、0805、1206、1210、2010、2512 => 0.07 ~ 0.7 N (7.1 ~ 71.4 gf)

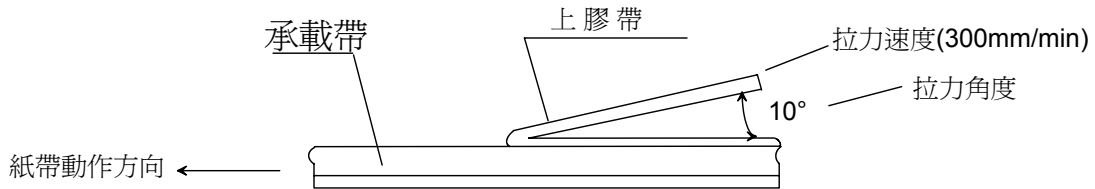

11.4 包裝型式 (Packaging Model):

TYPE	Tape Width	Packaging QTY (pcs / reel)															
		TH								TP				TE			
		2 mm Pitch								4 mm Pitch				4 mm Pitch			
		TH	H0	H1	H2	H3	H4	H5	H6	TP	P2	P3	P4	TE	E2	E3	E4
RTT01	8 mm	10,000	15,000	20,000	20,000	30,000	40,000	50,000	60,000	--	--	--	--	--	--	--	--
RTT02	8 mm	10,000	--	20,000	20,000	30,000	40,000	50,000	60,000	--	--	--	--	--	--	--	--
RTT03	8 mm	--	--	--	--	--	--	--	--	5,000	10,000	15,000	20,000	--	--	--	--
RTT05	8 mm																
RTT06	8 mm																
RTT12	8 mm																
RTT20	12 mm	--	--	--	--	--	--	--	--	--	--	--	4,000	8,000	12,000	16,000	
RTT25	12 mm																
Reel Type		7"	7"	7"	10"	13"	13"	13"	13"	7"	10"	13"	13"	7"	10"	13"	13"

TYPE	Tape Width	Bulk Case (pcs / case)	
RTT02	8 mm		50,000
RTT03	8 mm		25,000
RTT05	8 mm		10,000
RTT06	8 mm		5,000
RTT12	8 mm		--
RTT20	12 mm		--
RTT25	12 mm		--

11.4.1 典型包裝型式:

TH、TP材質：紙帶 & PE帶

TE材質：浮凸膠帶

11.4.2 其他包裝型式應客戶之需求而包裝

11.5 塑膠圓盤尺寸(Reel Dimensions):

Unit : mm

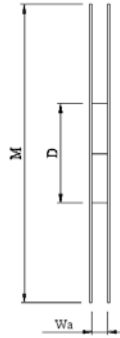
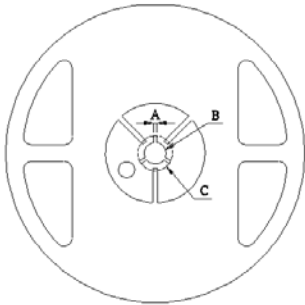

Reel Type/ Tape	Wa	M	A	B	C	D
7" reel for 8 mm tape	9.0 ± 0.5	178 ± 2.0	2.0 ± 0.5	13.5 ± 0.5	21.0 ± 0.5	60.0 ± 1.0
7" reel for 12 mm tape	13.8 ± 0.5	178 ± 2.0				80.0 ± 1.0
10" reel for 8 mm tape	10.0 ± 0.5	254 ± 2.0				100.0 ± 1.0
13" reel for 8 mm tape	10.0 ± 0.5	330 ± 2.0				100.0 ± 1.0

11.6 標籤表示(Label):

電腦料號: 0805T 504J103 5000 PCS R09010001

型別: 0805T

容許差: 5%

阻值: 10K

數量: 5000 PCS

Pb-free

流水號: 001

成品料號: RTT05103JTP

成品批號: [Barcode]

Logo: PAGODA

R 0 9 0 1 0 0 0 1

流水號: 001

週: 09

西元年最後二碼: 09

RALEC

11.7 內盒尺寸

卷數	D 尺寸(mm)
1	12
2	24
3	36
4	48
5	60
6	72
7	84
8	96
9	108
10	120

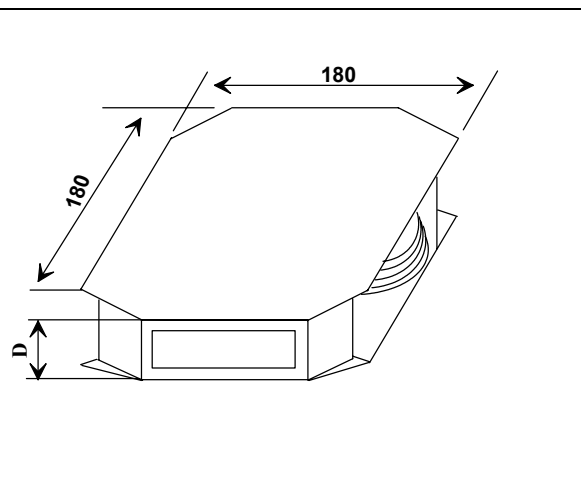

11.8外箱尺寸

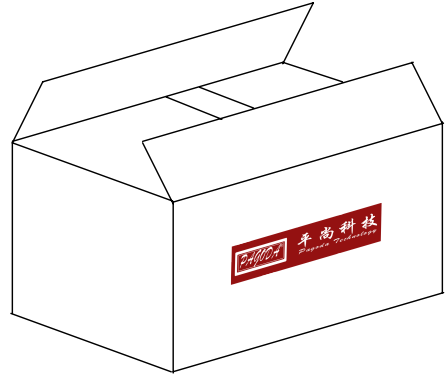
10R內盒個數	長(mm)	寬(mm)	厚(mm)	
2	272	205	210	
4	375	280	210	
8	544	380	210	

11.9外銷中國大陸外箱尺寸

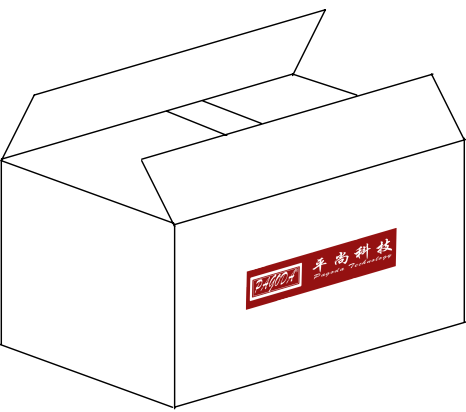
10R內盒個數	長(mm)	寬(mm)	厚(mm)	
2	272	205	210	
4	375	280	210	
8	544	380	210	

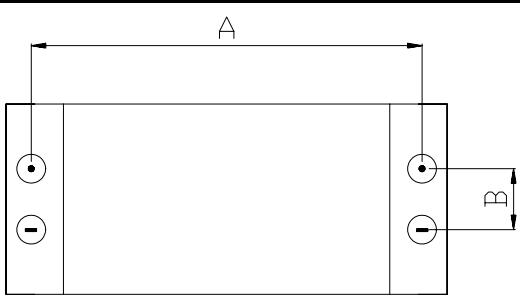
背面電極量測		Unit : mm		
	DIM	A	B	
	TYPE			
●	Current Terminal			
⊖	Voltage Terminal			
	RTT01	0.44± 0.05	0.22 ± 0.05	
	RTT02	0.80± 0.05	0.24 ± 0.05	
	RTT03	1.35± 0.05	0.35 ± 0.05	
	RTT05	1.80 ± 0.05	0.35 ± 0.05	
	RTT06	2.90 ± 0.05	0.35 ± 0.05	
	RTT12	2.90 ± 0.05	0.35 ± 0.05	
	RTT20	4.50 ± 0.05	1.15 ± 0.05	
	RTT25	5.90 ± 0.05	1.60 ± 0.05	

13 儲存期限

13.1 在儲存環境 $25 \pm 5^{\circ}\text{C}$ 、 $60 \pm 15\%$ 之條件下可儲存二年。

14 電子信息產品標示外箱上以下列標籤進行標示:(外銷中國大陸)

