

18000 series

Snap-action momentary pushbutton switches

Distinctive features and specifications

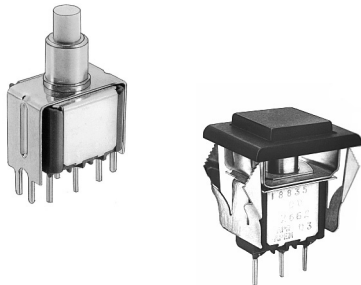

- Panel and PC mount models
- Snap-in panel mounting version
- Tactile feedback

ELECTRICAL SPECIFICATIONS

- Max. current/voltage rating with resistive load :
 - gold plated brass contacts : 100mA - 30VDC
 - gold plated silver contacts : 1A 125VAC, 1A 30VDC
 - Initial contact resistance : 50 mΩ max.
 - Insulation resistance : 1.000 MΩ min.
 - Dielectric strength : 1.000 Vrms 50 Hz min.
 - Electrical life : 60.000 cycles at full load
- Models for high currents : see 18635A and 18645A at the end of the series.

MATERIALS

- Case : PBT
- Actuator : polyamide, glass filled
- Bushing : brass, nickel plated
- Housing : stainless steel
- Bracket : tin plated steel
- Contacts
 - AD : silver, gold plated
 - CD : brass, gold plated
- Terminal seal : epoxy

GENERAL SPECIFICATIONS

- Total travel : 0,5 mm (.019)
- Torque : 1,25 Nm (.922 Ft.lb) max. applied to nut
- Operating temperature : -30°C to +65°C
- Soldering : 300°C, 3 sec. max.

18000 series

Snap-action momentary pushbutton switches

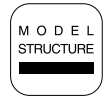

Overview

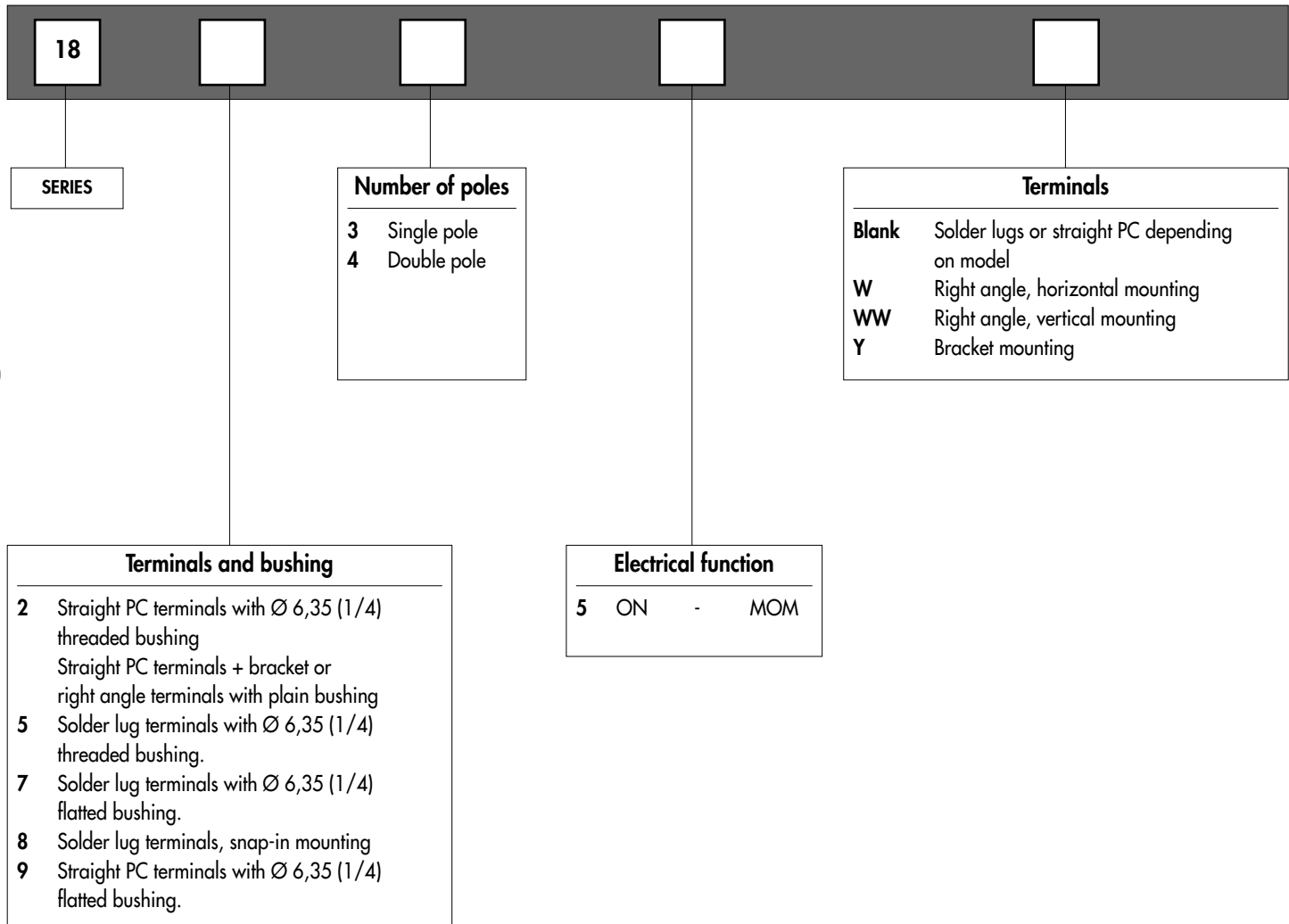

ABOUT THIS SERIES

On the following pages, you will find successively :
 - model structure of switches
 - options in the same order as in above chart

Dimensions : first dimensions are in mm while inches are shown as bracketted numbers.



NOTICE : please note that not all combinations of above numbers are available.
 Refer to the following pages for further information.

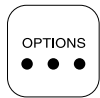

18000 series

Snap-action momentary pushbutton switches

Overview

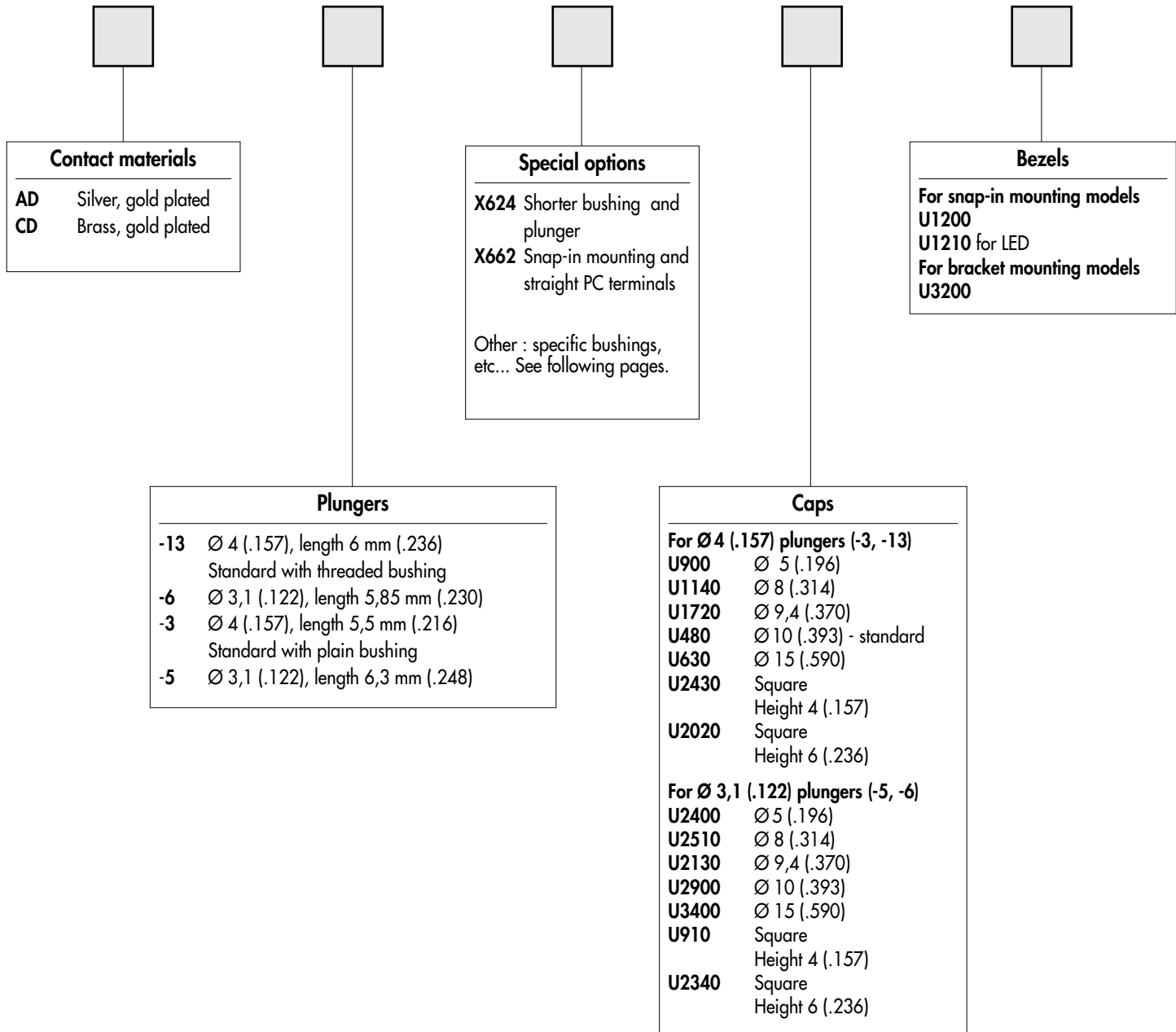

Sealing boots are available to protect the switches against dust and water. They are presented in section H.



Mounting accessories : standard hardware supplied with all models with Ø 6,35 (1/4) threaded bushing :
 2 hex nuts 8 mm (.314) across flats, 1 locking ring and 1 lockwasher.
 Standard and special hardware available are presented in section I.



Packaging unit : 25 pieces for W, WW double pole and 18800 models
 50 pieces for other models.

18000 series

Snap-action momentary pushbutton switches

Threaded bushing $\varnothing 6,35$ (1/4) : 18500 - 18700 - 18200

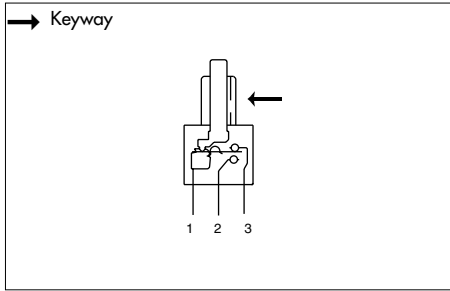
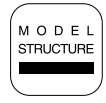

- Solder lug or straight PC terminals
- Epoxy sealed terminals standard

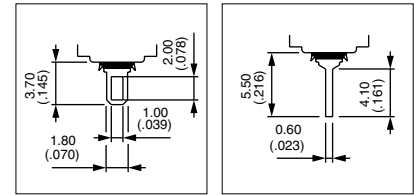

MODEL STRUCTURE

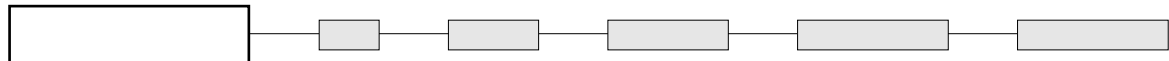

Shown with standard plunger (-13)

Solder lug terminals : 18500



Single pole
18535

Double pole
18545

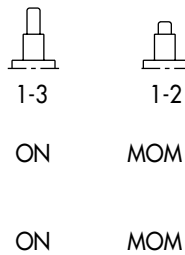

→ Keyway

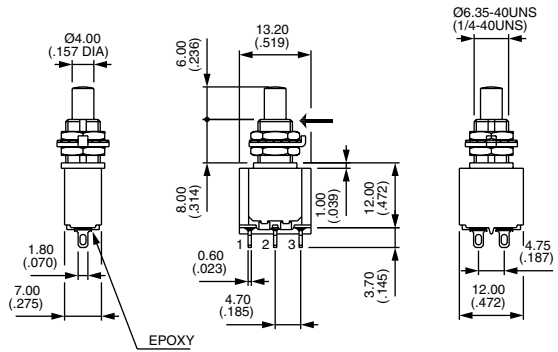

Flatted bushing - solder lug terminals : 18700



Single pole
18735

Double pole
18745

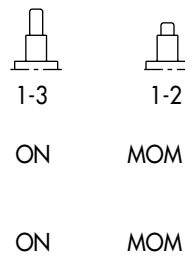

→ Flat

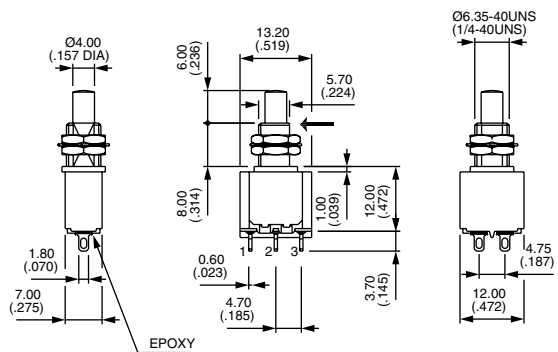

Straight PC terminals : 18200



Single pole
18235

Double pole
18245

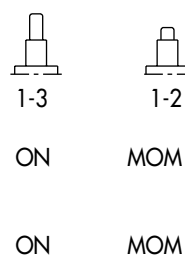

→ Keyway

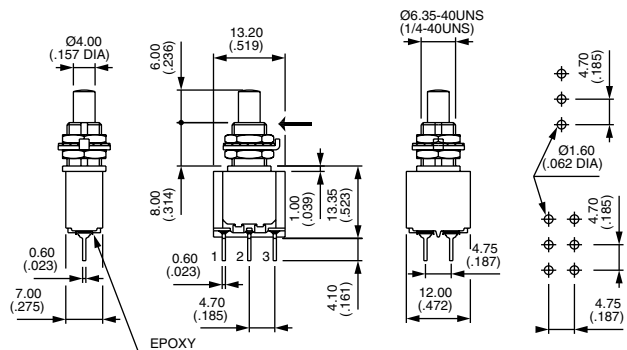



18000 series

Snap-action momentary pushbutton switches

Threaded bushing $\varnothing 6,35$ (1/4) : 18900 - Snap-in mounting : 18800

Flatted bushing - straight PC terminals : 18900

→ Flat



Single pole
18935

Double pole
18945



ON



MOM

ON

MOM

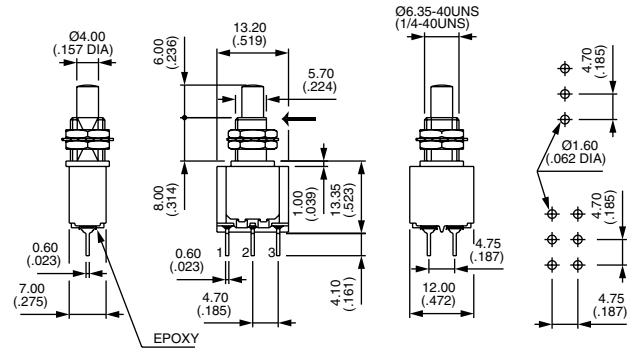

Snap-in mounting - solder lug terminals : 18800

Shown with cap U910 + U1200



Single pole
18835

Double pole
18845



ON



MOM

ON

MOM

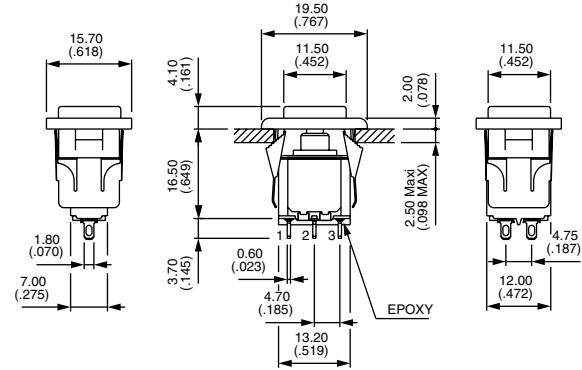

Available with straight PC terminals : see X662 under "Special options".

PANEL CUT-OUT

18500 - 18200

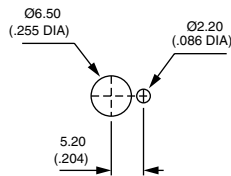

18700 - 18900

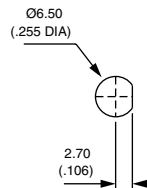

PANEL CUT-OUT

18800

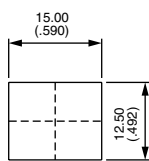

With bezel **U1200**

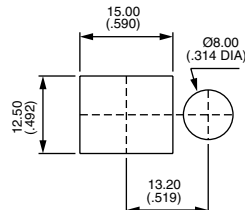

With bezel **U1210 for LED**

B

18000 series

Snap-action momentary pushbutton switches

Plain bushing : 18200Y - 18200W - 18200WW

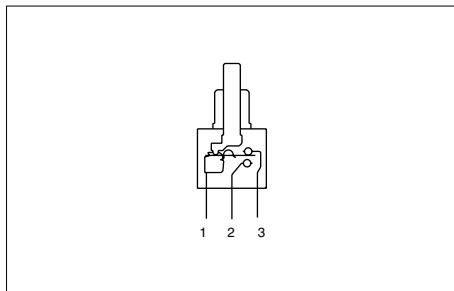
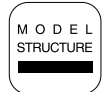

- Straight PC or right angle terminals
- Epoxy sealed terminals standard

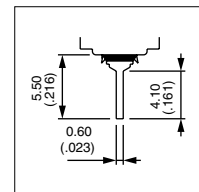

MODEL STRUCTURE

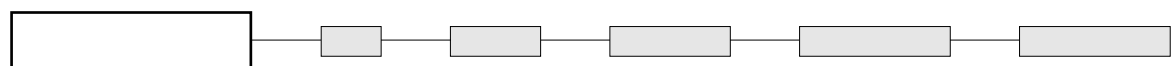

Shown with standard plunger (-3)

Straight PC terminals - bracket mounting - single pole 18230Y

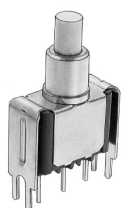

18235Y

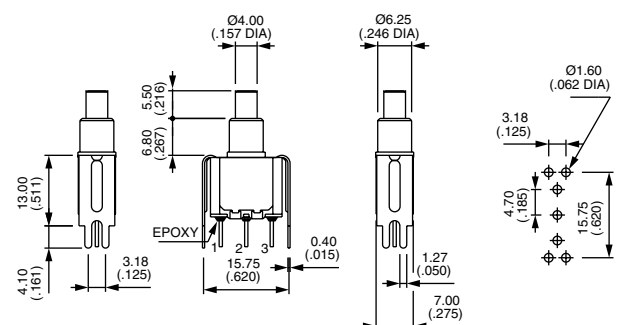
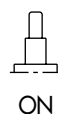

Straight PC terminals - bracket mounting - double pole 18240Y



18245Y

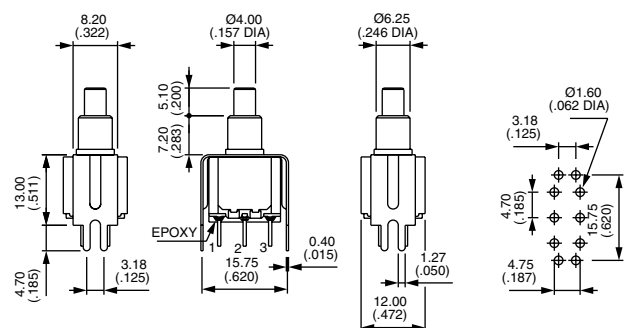

Right angle terminals - horizontal : 18200W

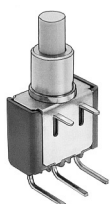

Single pole
18235W

Double pole
18245W

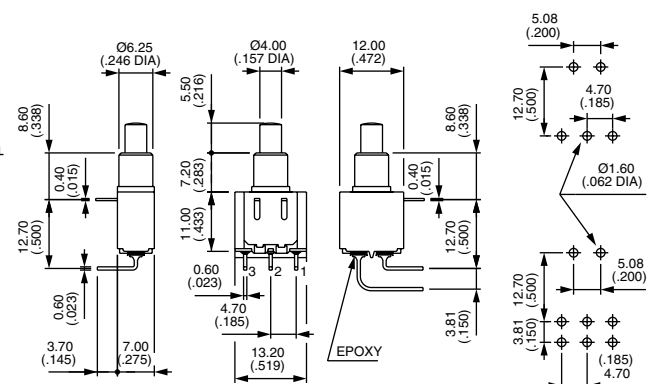
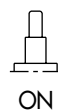



18000 series

Snap-action momentary pushbutton switches

Right angle terminals - vertical : 18200WW

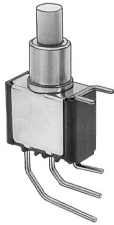

Single pole
18235WW

Double pole
18245WW



1-3

ON



1-2

MOM

ON

MOM

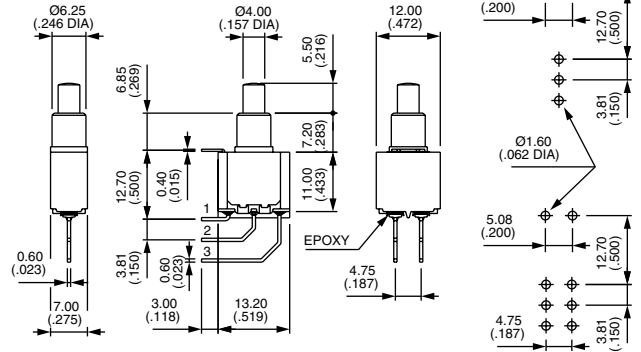

B

CONTACT MATERIALS

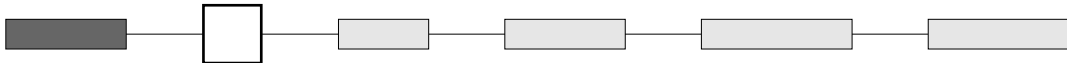

AD Silver, gold plated
CD Brass, gold plated

PLUNGERS

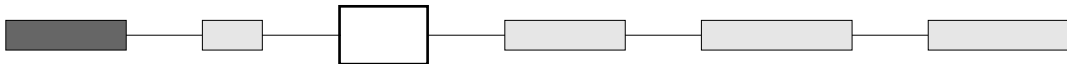

Dash compulsory before plunger code.

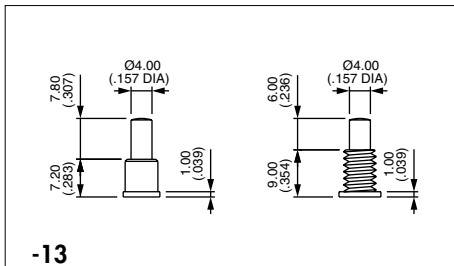

Ø 4 (.157) - standard with threaded bushing

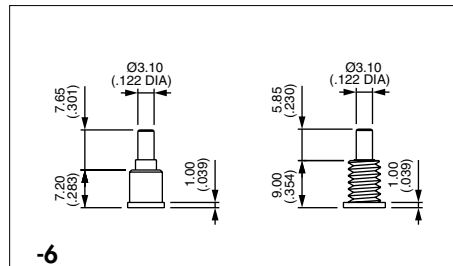

Ø 3,1 (.122)



If plunger not specified, we supply former default option -13.

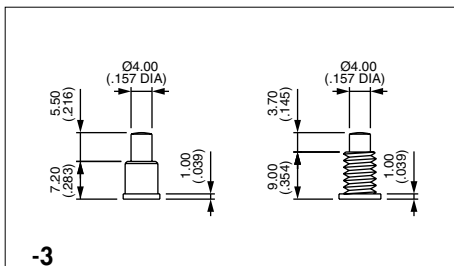

Ø 4 (.157) - standard with plain bushing

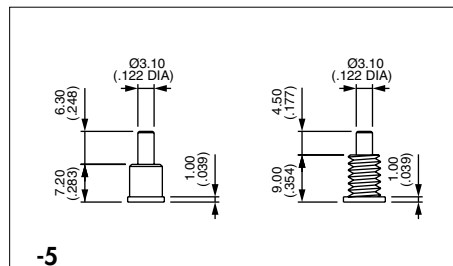

Ø 3,1 (.122)

18000 series

Snap-action momentary pushbutton switches

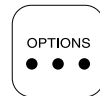

SPECIAL OPTIONS

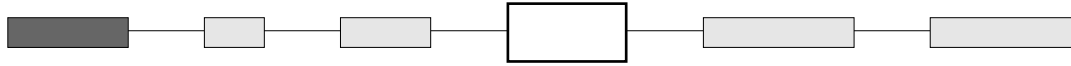

X624 Straight PC terminals - bracket mounting - **with shorter bushing and plunger**

Single pole

18235Y -2X624



ON



MOM

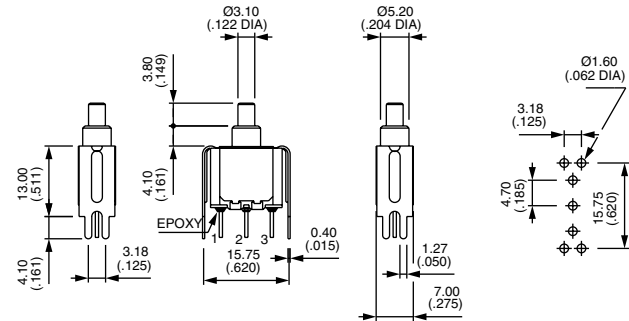

Double pole

18245Y -2X624



ON



MOM

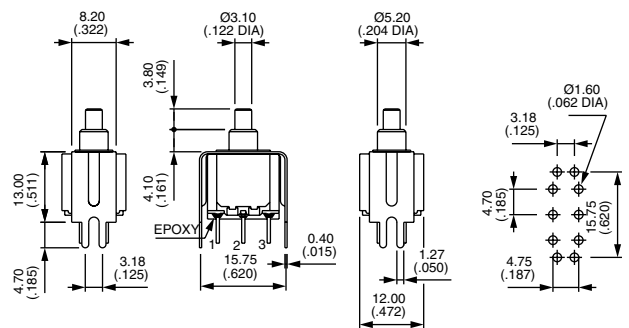

X662 Snap-in mounting - straight PC terminals

Single pole

18835 X662



ON



MOM

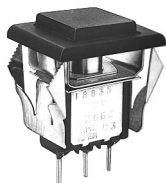

Double pole

18845 X662

ON

MOM

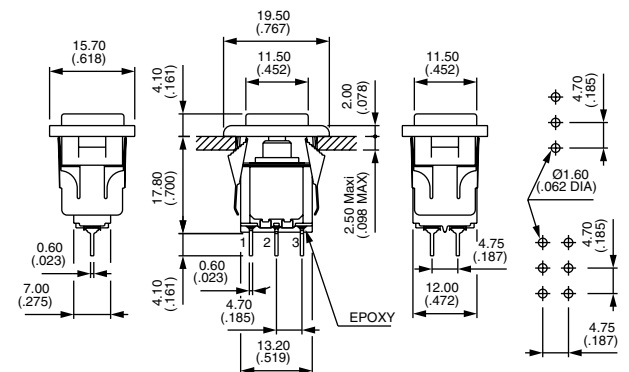



18000 series

Snap-action momentary pushbutton switches

SPECIAL OPTIONS (continued)

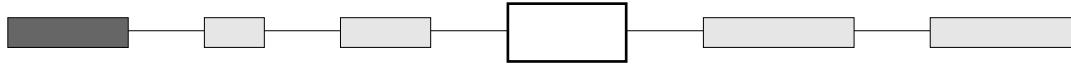

X371 Plain bushing \varnothing 6,25 mm (.246) (instead of standard threaded bushing).

X372 Shorter threaded bushing \varnothing 6,35 (1/4). Height 7 mm (.274).

X386 Threaded bushing \varnothing 6,35 mm (1/4) to replace plain bushing on models W - WW and Y.

X438 Plain bushing \varnothing 6,25 mm (.246). Height 7,2 mm (.283) - without shoulder.

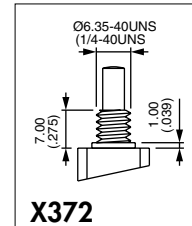

X372

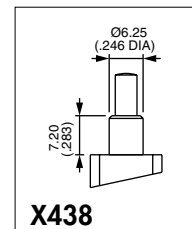

X438

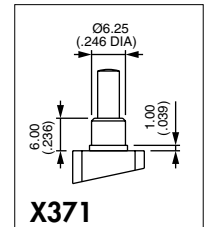

X371

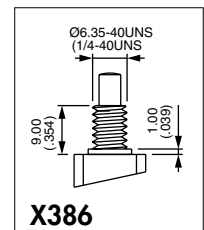

X386

B

CAPS

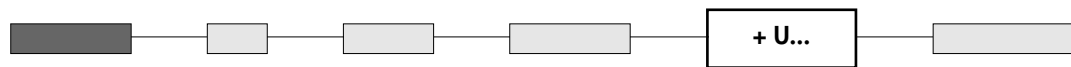

Caps for \varnothing 4 (.157) plungers (-13, -3)

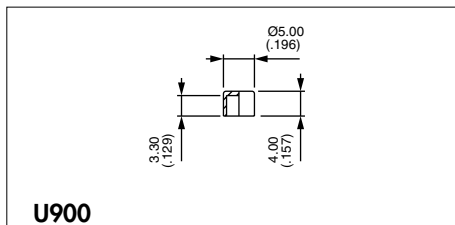

U900

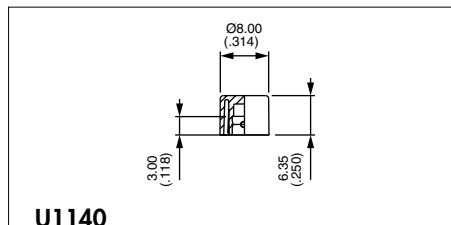

U1140

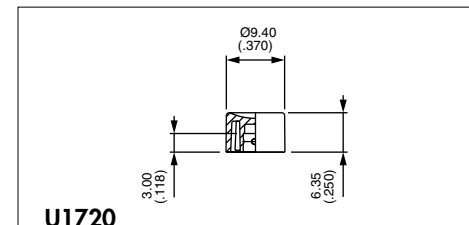

U1720

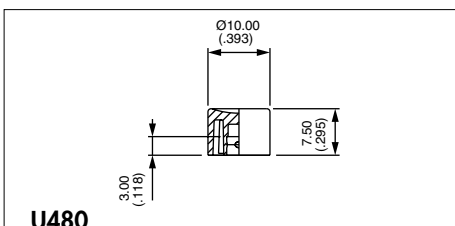

U480

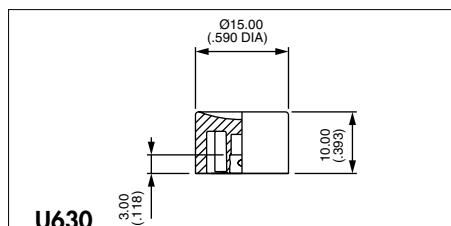

U630

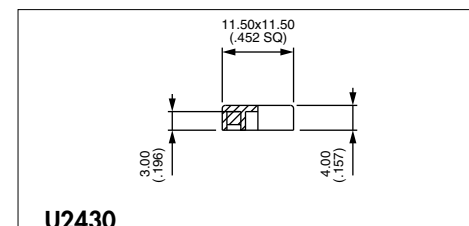

U2430

Square

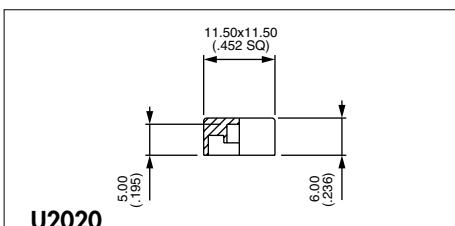

U2020

Square

Cap colours			
Replace last "0" by number			
1	blue	5	yellow
1/4	dark blue	6	red
2	black	7	ivory
3	green	7/1	white
4	grey	9	orange

18000 series

Snap-action momentary pushbutton switches

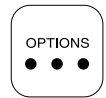

CAPS (continued)

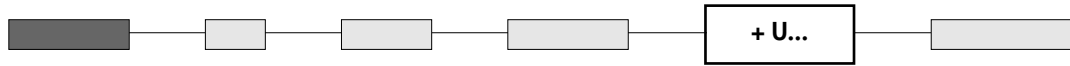

Caps for Ø 3,1 (.122) plungers (-5, -6)

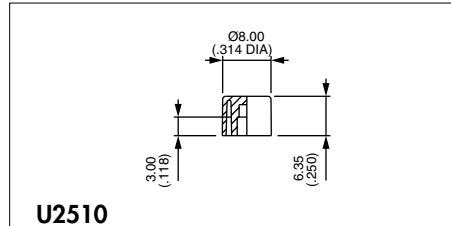
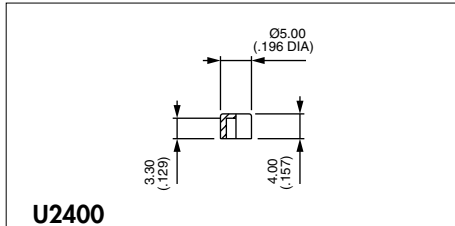

Cap colours	
Replace "0" by number	
1	blue
1/4	dark blue
2	black
3	green
4	grey
5	yellow
6	red
7	ivory
7/1	white
9	orange

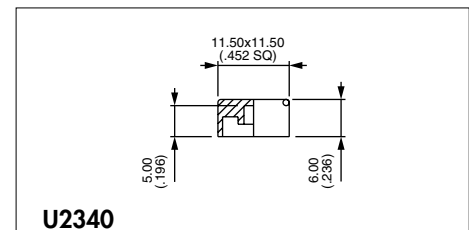
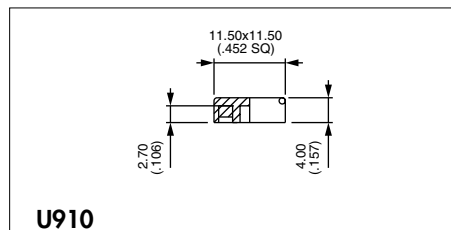
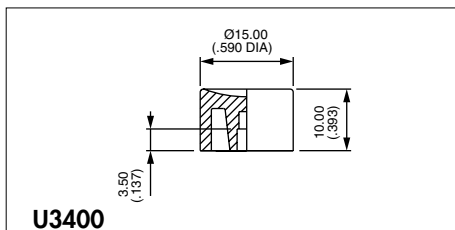
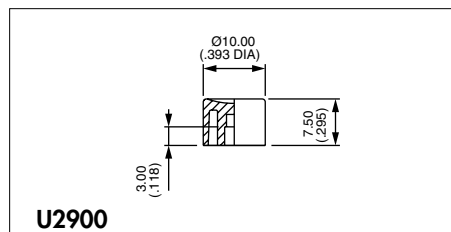
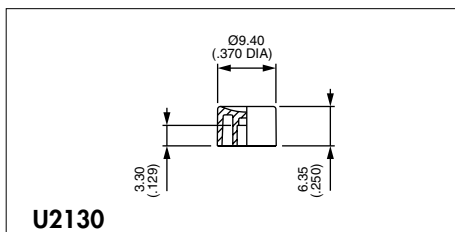

Caps for 18800 and 18800X662 models

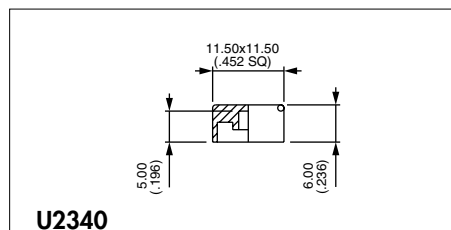
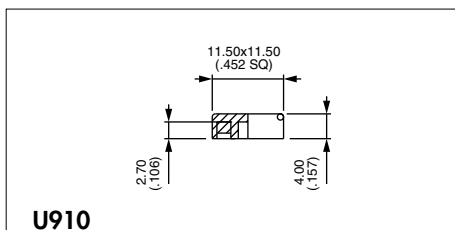



18000 series

Snap-action momentary pushbutton switches

DRESS NUTS

For models with threaded bushing (18500 - 18700 - 18200 - 18900)

Chrome plated - Order separately.

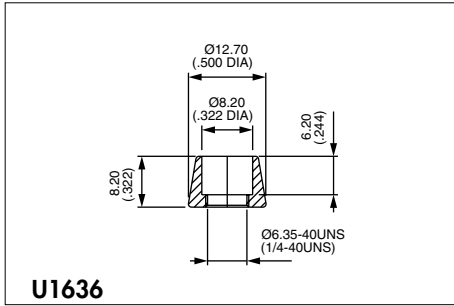

For caps U1140 and U2510

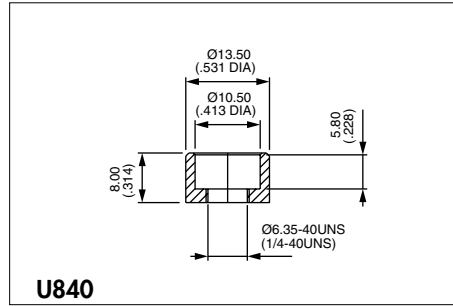

For cap U480 and U2900

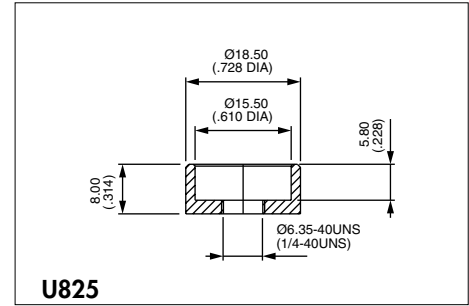

For caps U630 and U3400

BEZELS

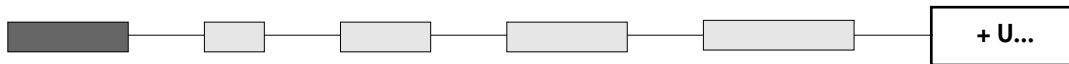

For snap-in models (18800 - 18800X662)

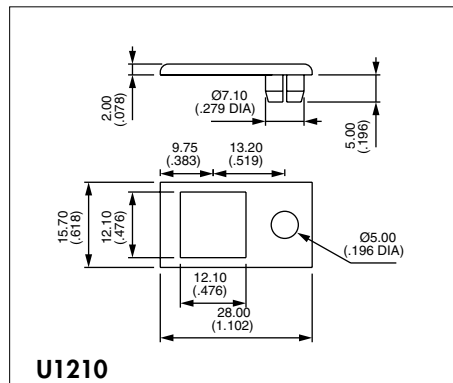
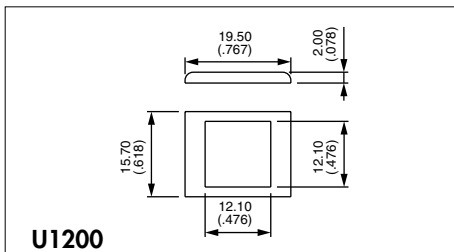

For LED Ø 5 - not supplied

Bezel colours	
Replace last "0" by number	
1	blue
1/4	dark blue
2	black
3	green
4	grey
5	yellow
6	red
7	ivory
7/1	white
9	orange

For bracket mounting models (18200Y & 18200YX624)

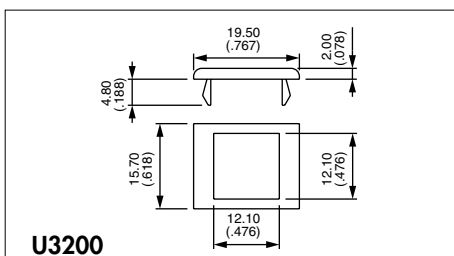

STANDARD PANEL MOUNTING

Panel thickness with bezel : 1 mm (.039) to 2,5 mm (.098)

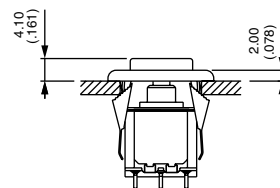

18800 + U910 + U1200

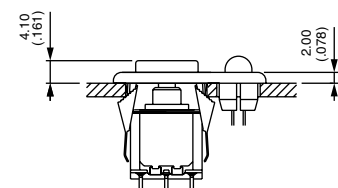

18800 + U910 + U1210

18000 series

Snap-action momentary pushbutton switches

For high currents

Tactile feedback

B

ELECTRICAL SPECIFICATIONS

- Max. current/voltage rating with resistive load :
3A 250VAC - 6A 125VAC - 7A 30VDC
- Initial contact resistance : 20 m Ω max. at 0,1A 3VDC
- Insulation resistance : 200.000 M Ω min. between terminals and frame
- Dielectric strength : 1.500 Vrms 50 Hz min.
- Electrical life : 60.000 cycles at full load

GENERAL SPECIFICATIONS

- Travel : 0,90 mm (.035) approx.
- Operating temperature :
-30°C to +85°C

MATERIALS

- Case : diallyphthalate (DAP)
- Actuator : glass filled polyester
- Bushing : brass, nickel plated
- Housing : stainless steel
- Contacts : silver
- Terminal seal : epoxy

18000 series

Snap-action momentary pushbutton switches

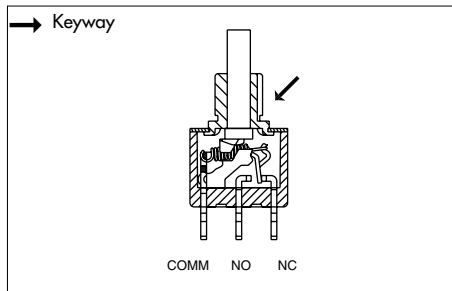

- Threaded bushing $\varnothing 6,35$ (1/4)
- Solder lug terminals
- Epoxy sealed terminals

MODEL
STRUCTURE

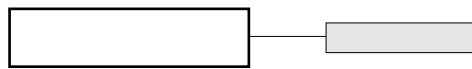

Single pole



18635A

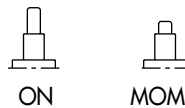

→ Keyway

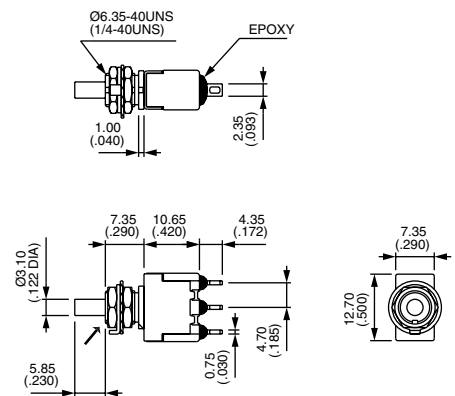

Double pole

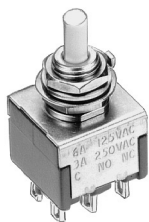

18645A

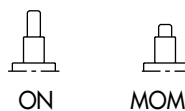

→ Keyway

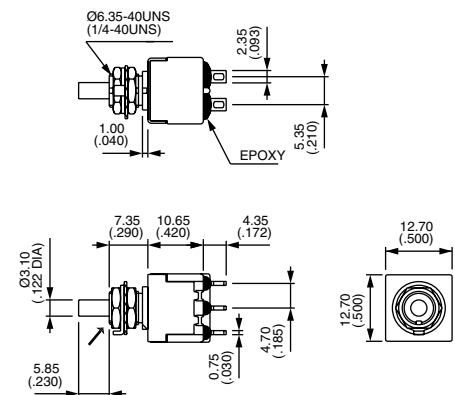

CAPS



Round	
U2400	$\varnothing 5$ (.196)
U2510	$\varnothing 8$ (.314)
U2130	$\varnothing 9,4$ (.370)
U2900	$\varnothing 10$ (.393)
U3400	$\varnothing 15$ (.590)

Square	
U910	Height 4 (.157)
U2340	Height 6 (.236)

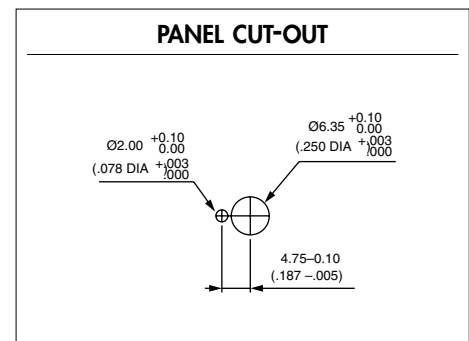

For cap dimensions, see "Caps for $\varnothing 3,1$ (.122) plungers" on the preceding pages.