

# MUR1510G, MUR1515G, MUR1520G, MUR1540G, MUR1560G, MURF1560G, SUR81520G, SUR81560G



ON Semiconductor®

<http://onsemi.com>

## Switch-mode Power Rectifiers

These state-of-the-art devices are a series designed for use in switching power supplies, inverters and as free wheeling diodes.

### Features

- Ultrafast 35 and 60 Nanosecond Recovery Time
- 175°C Operating Junction Temperature
- High Voltage Capability to 600 V
- ESD Ratings:
  - ◆ Machine Model = C
  - ◆ Human Body Model = 3B
- Low Forward Drop
- Low Leakage Specified @ 150°C Case Temperature
- Current Derating Specified @ Both Case and Ambient Temperatures
- SUR8 Prefix for Automotive and Other Applications Requiring Unique Site and Control Change Requirements; AEC-Q101 Qualified and PPAP Capable
- All Packages are Pb-Free\*

### Mechanical Characteristics:

- Case: Epoxy, Molded
- Weight: 1.9 Grams (Approximately)
- Finish: All External Surfaces Corrosion Resistant and Terminal Leads are Readily Solderable
- Lead Temperature for Soldering Purposes: 260°C Max. for 10 Seconds

## ULTRAFAST RECTIFIERS 15 AMPERES, 100–600 VOLTS

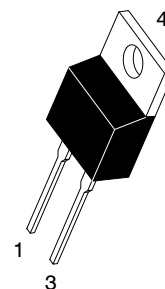
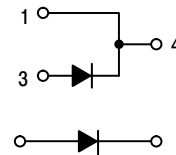

TO-220AC  
CASE 221B  
STYLE 1

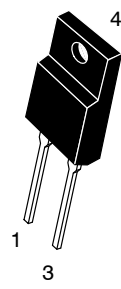

TO-220 FULLPAK  
CASE 221AG  
STYLE 1

### MARKING DIAGRAMS

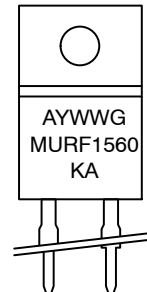

- A = Assembly Location
- Y = Year
- WW = Work Week
- G = Pb-Free Package
- U15xx = Device Code  
xx = 10, 15, 20, 40 or 60
- KA = Diode Polarity

\*For additional information on our Pb-Free strategy and soldering details, please download the ON Semiconductor Soldering and Mounting Techniques Reference Manual, SOLDERRM/D.

### ORDERING INFORMATION

See detailed ordering and shipping information in the package dimensions section on page 7 of this data sheet.

**MUR1510G, MUR1515G, MUR1520G, MUR1540G, MUR1560G, MURF1560G,  
SUR81520G, SUR81560G**

**MAXIMUM RATINGS**

Rating	Symbol	MUR/SUR8					Unit
		1510	1515	1520	1540	1560	
Peak Repetitive Reverse Voltage Working Peak Reverse Voltage DC Blocking Voltage	$V_{RRM}$ $V_{RWM}$ $V_R$	100	150	200	400	600	V
Average Rectified Forward Current (Rated $V_R$ )	$I_{F(AV)}$	15 @ $T_C = 150^\circ\text{C}$			15 @ $T_C = 145^\circ\text{C}$		A
Peak Rectified Forward Current (Rated $V_R$ , Square Wave, 20 kHz)	$I_{FRM}$	30 @ $T_C = 150^\circ\text{C}$			30 @ $T_C = 145^\circ\text{C}$		A
Nonrepetitive Peak Surge Current (Surge applied at rated load conditions halfwave, single phase, 60 Hz)	$I_{FSM}$	200			150		A
Operating Junction Temperature and Storage Temperature Range	$T_J, T_{stg}$	-65 to +175					$^\circ\text{C}$

Stresses exceeding those listed in the Maximum Ratings table may damage the device. If any of these limits are exceeded, device functionality should not be assumed, damage may occur and reliability may be affected.

**THERMAL CHARACTERISTICS**

Characteristic	Symbol	Value	Unit
MUR1510 Series: Thermal Resistance Junction-to-Case Junction-to-Ambient	$R_{\theta JC}$ $R_{\theta JA}$	1.5 73	$^\circ\text{C/W}$
MURF1560: Thermal Resistance Junction-to-Case Junction-to-Ambient	$R_{\theta JC}$ $R_{\theta JA}$	4.25 75	$^\circ\text{C/W}$

**ELECTRICAL CHARACTERISTICS**

Characteristic	Symbol	1510	1515	1520	1540	1560	Unit
Maximum Instantaneous Forward Voltage (Note 1) ( $i_F = 15\text{ A}$ , $T_C = 150^\circ\text{C}$ ) ( $i_F = 15\text{ A}$ , $T_C = 25^\circ\text{C}$ )	$v_F$		0.85 1.05		1.12 1.25	1.20 1.50	V
Maximum Instantaneous Reverse Current (Note 1) (Rated DC Voltage, $T_C = 150^\circ\text{C}$ ) (Rated DC Voltage, $T_C = 25^\circ\text{C}$ )	$i_R$		500 10		500 10	1000 10	$\mu\text{A}$
Maximum Reverse Recovery Time ( $I_F = 1.0\text{ A}$ , $di/dt = 50\text{ A}/\mu\text{s}$ )	$t_{rr}$		35			60	ns

Product parametric performance is indicated in the Electrical Characteristics for the listed test conditions, unless otherwise noted. Product performance may not be indicated by the Electrical Characteristics if operated under different conditions.

1. Pulse Test: Pulse Width = 300  $\mu\text{s}$ , Duty Cycle  $\leq 2.0\%$ .

MUR1510G, MUR1515G, MUR1520G, MUR1540G, MUR1560G, MURF1560G,  
SUR81520G, SUR81560G

MUR1510G, MUR1515G, MUR1520G, SUR81520G

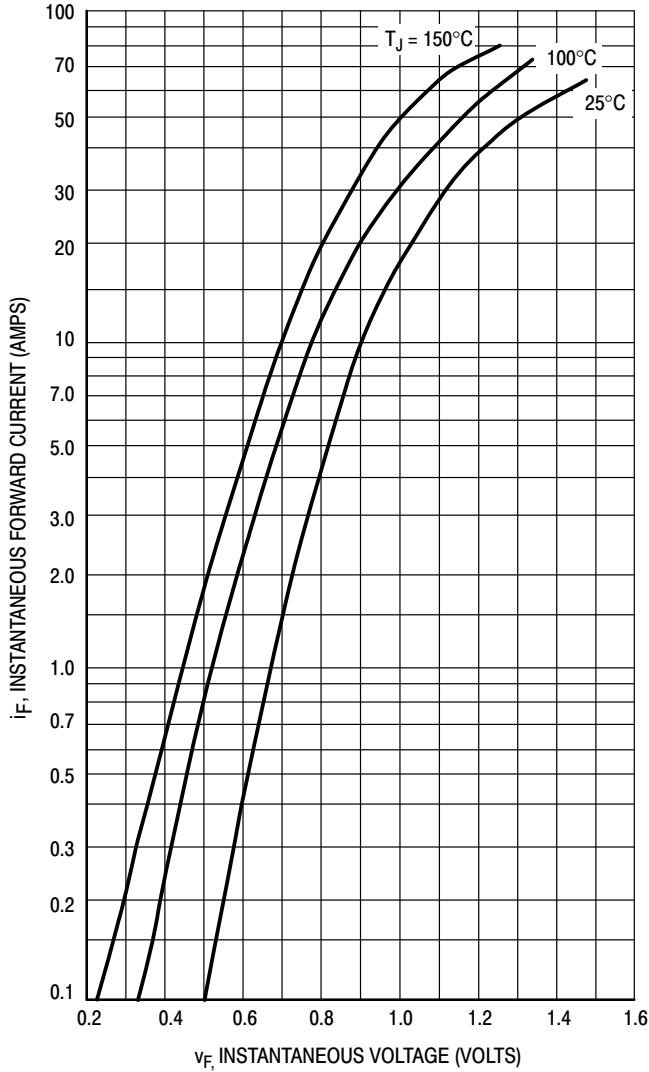

Figure 1. Typical Forward Voltage



Figure 2. Typical Reverse Current



Figure 3. Current Derating, Case

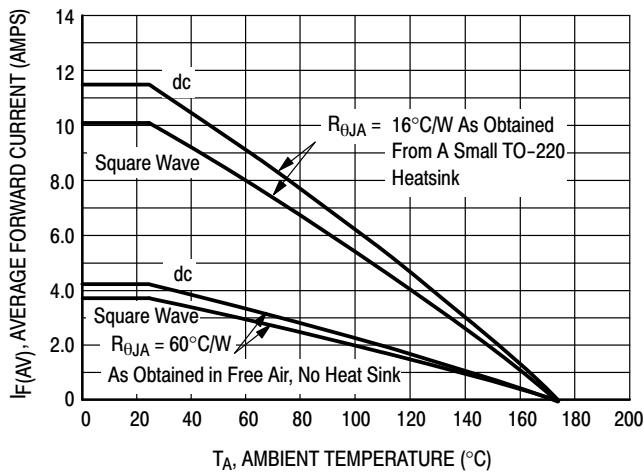

Figure 4. Current Derating, Ambient



Figure 5. Power Dissipation

MUR1510G, MUR1515G, MUR1520G, MUR1540G, MUR1560G, MURF1560G,  
SUR81520G, SUR81560G

MUR1540G

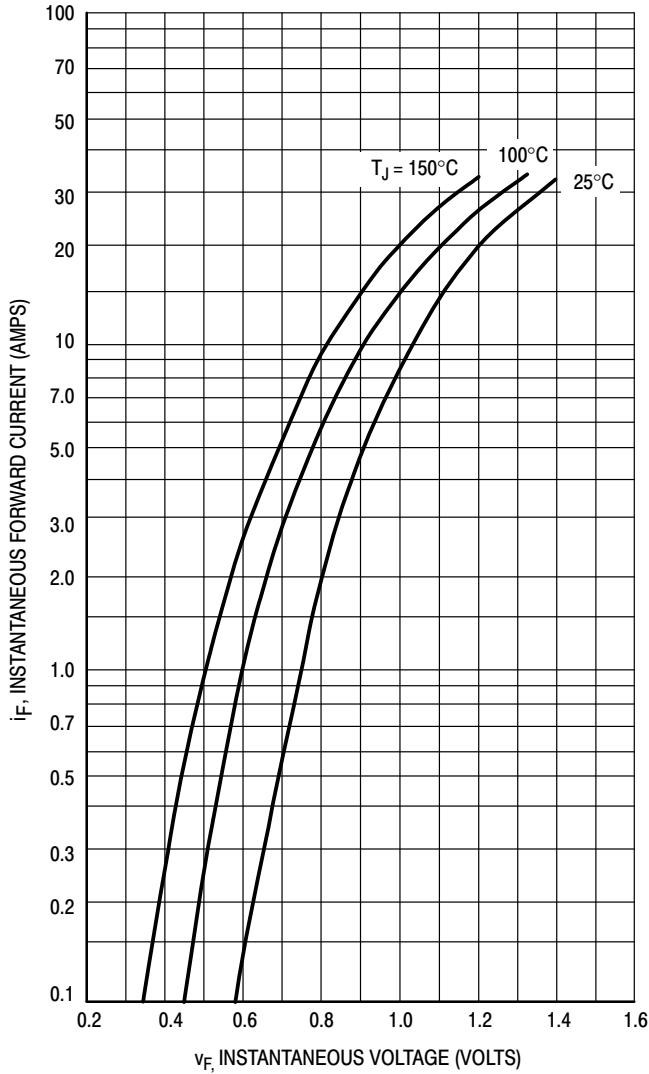

Figure 6. Typical Forward Voltage



Figure 7. Typical Reverse Current

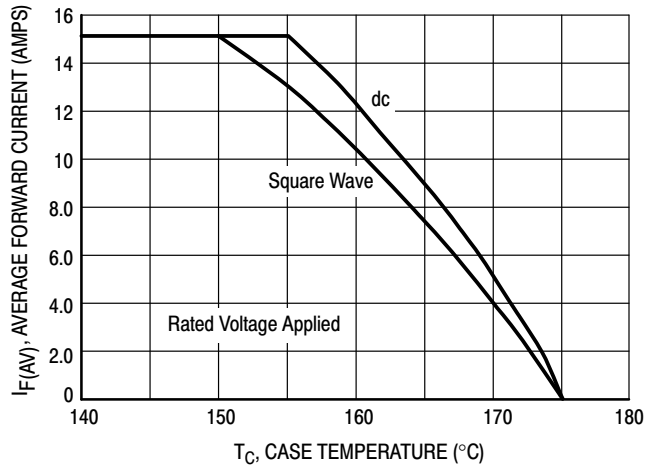

Figure 8. Current Derating, Case

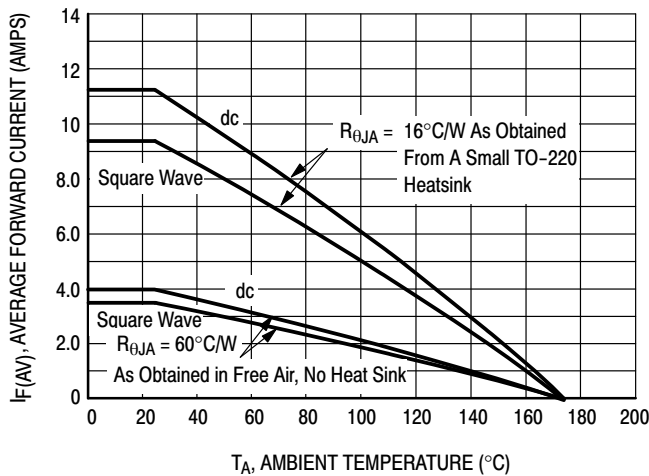

Figure 9. Current Derating, Ambient

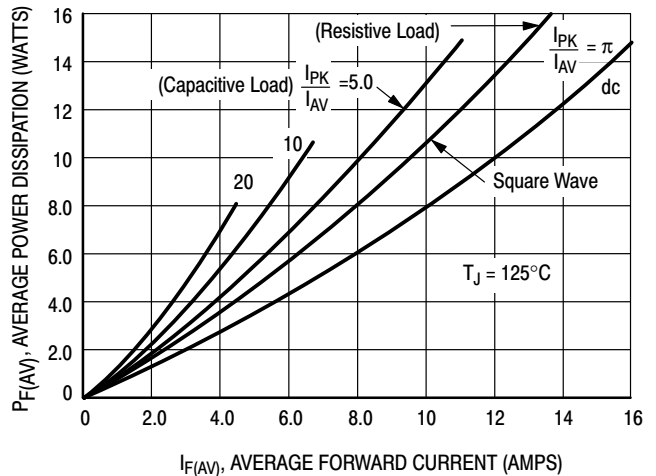

Figure 10. Power Dissipation

MUR1510G, MUR1515G, MUR1520G, MUR1540G, MUR1560G, MURF1560G,  
SUR81520G, SUR81560G

MUR1560G, MURF1560G, SUR81560G



Figure 11. Typical Forward Voltage

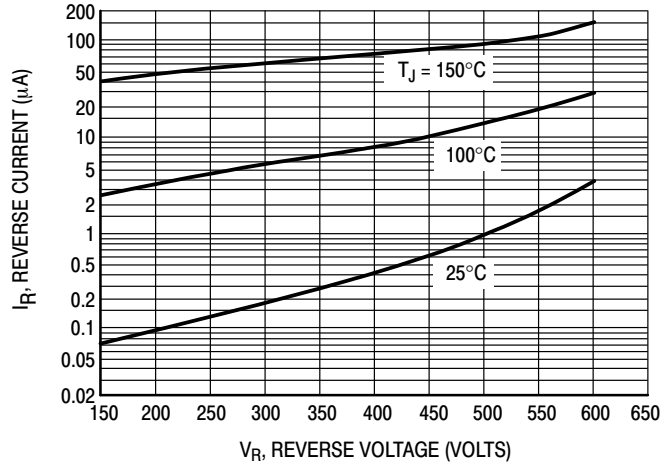

Figure 12. Typical Reverse Current

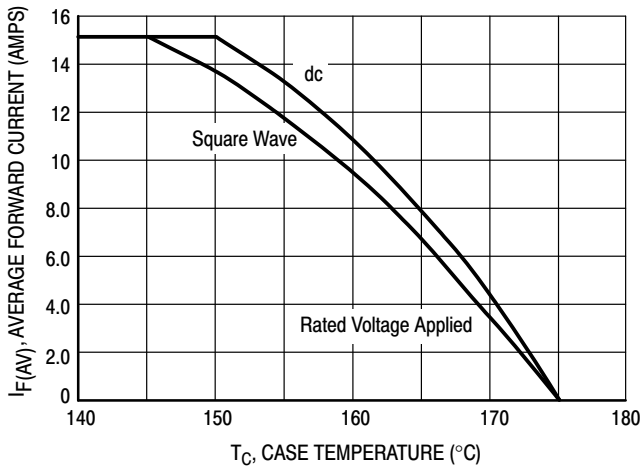

Figure 13. Current Derating, Case



Figure 14. Current Derating, Ambient

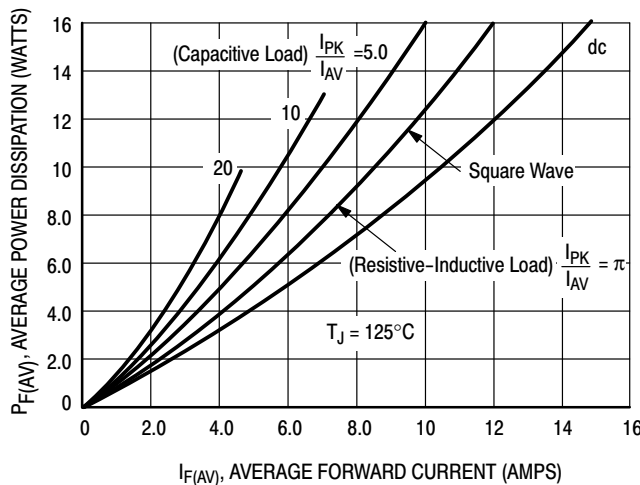

Figure 15. Power Dissipation

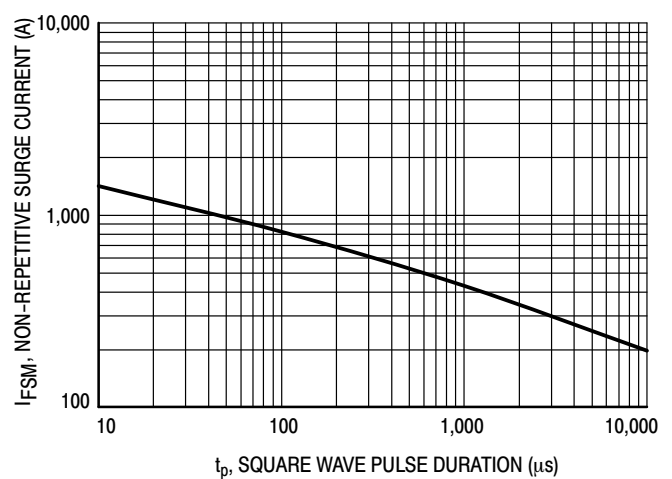
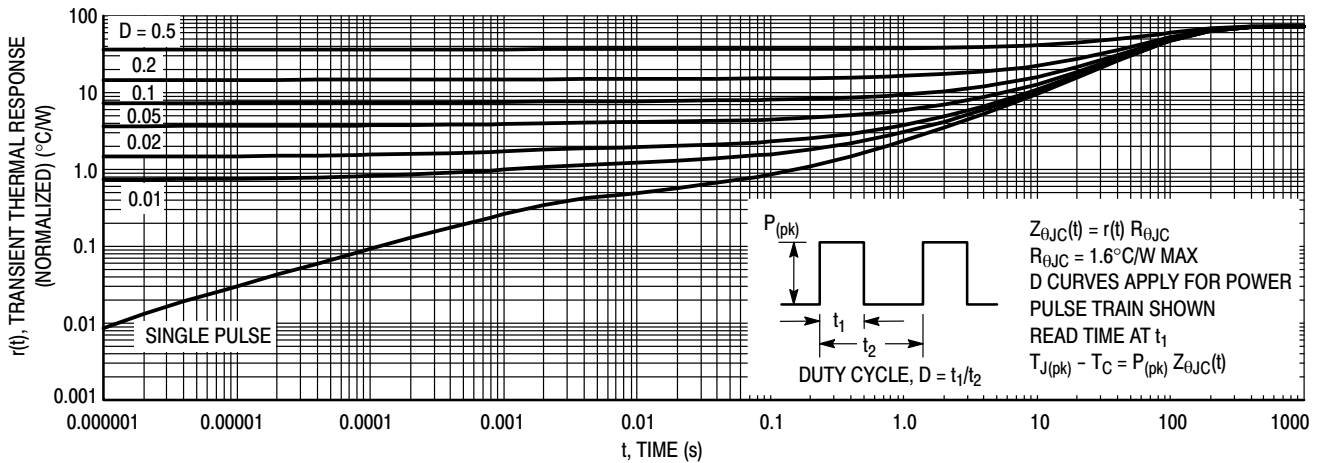
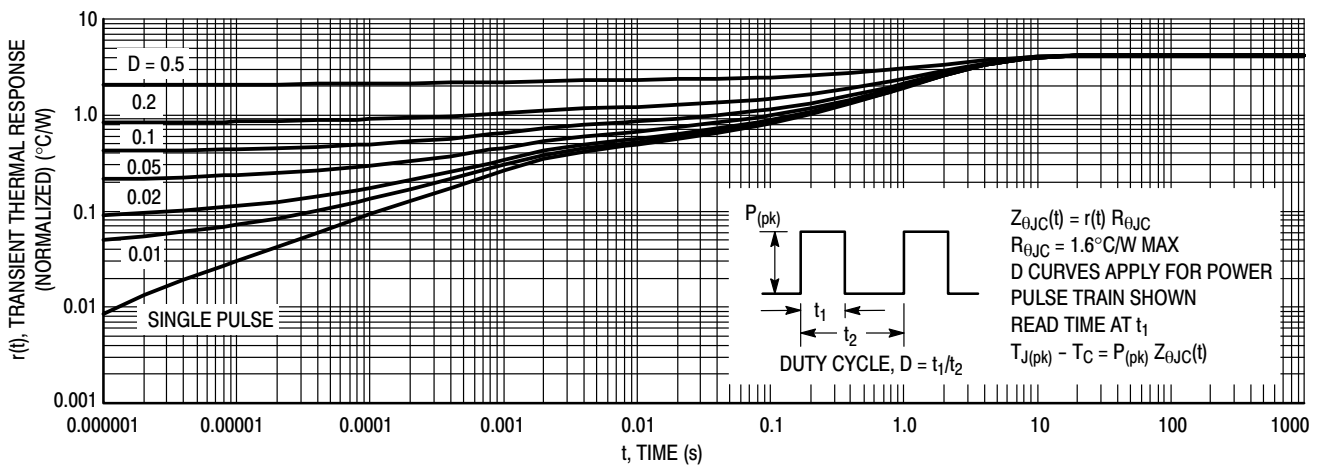
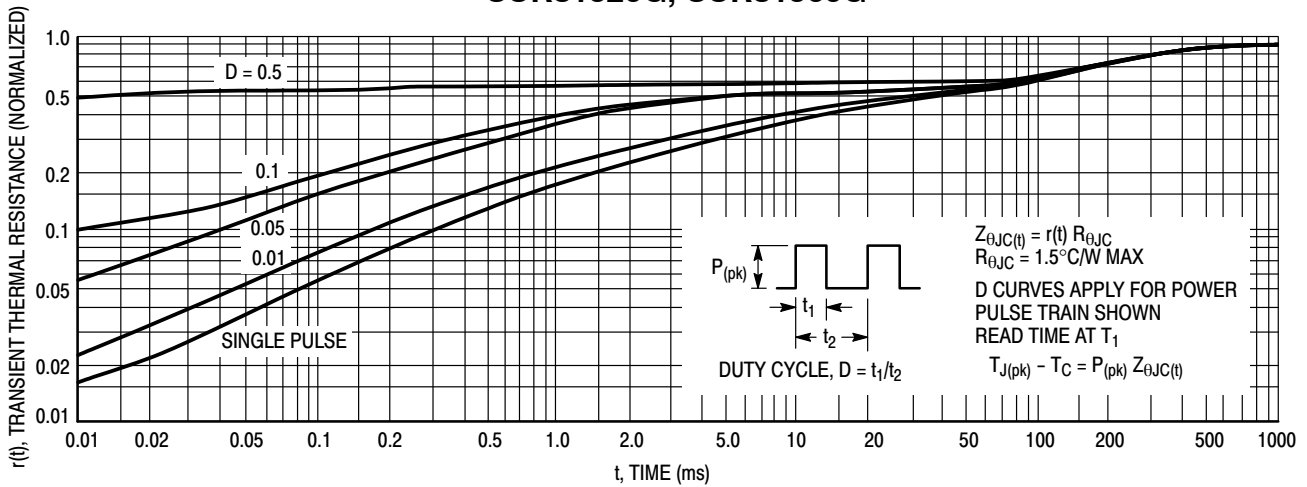

Figure 16. Typical Non-Repetitive Surge Current

\* Typical performance based on a limited sample size. ON Semiconductor does not guarantee ratings not listed in the Maximum Ratings table.

MUR1510G, MUR1515G, MUR1520G, MUR1540G, MUR1560G, MURF1560G,  
SUR81520G, SUR81560G



**MUR1510G, MUR1515G, MUR1520G, MUR1540G, MUR1560G, MURF1560G,  
SUR81520G, SUR81560G**

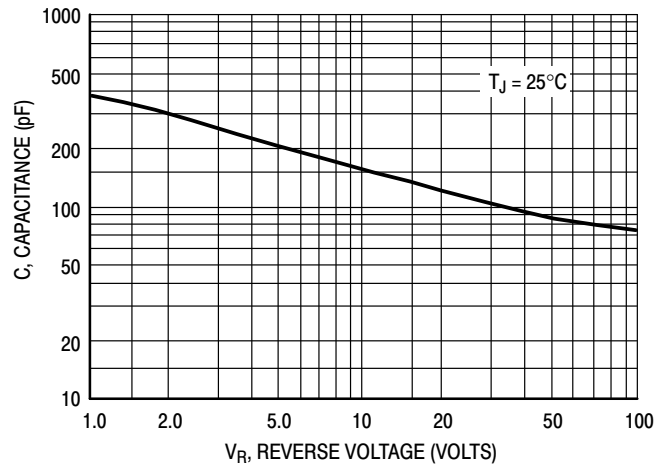

**Figure 20. Typical Capacitance**

**ORDERING INFORMATION**

Device	Package	Shipping <sup>†</sup>
MUR1510G	TO-220AC (Pb-Free)	50 Units / Rail
MUR1515G	TO-220AC (Pb-Free)	50 Units / Rail
MUR1520G	TO-220AC (Pb-Free)	50 Units / Rail
SUR81520G	TO-220AC (Pb-Free)	50 Units / Rail
MUR1540G	TO-220AC (Pb-Free)	50 Units / Rail
MUR1560G	TO-220AC (Pb-Free)	50 Units / Rail
SUR81560G	TO-220AC (Pb-Free)	50 Units / Rail
MURF1560G	TO-220FP (Pb-Free)	50 Units / Rail

<sup>†</sup>For information on tape and reel specifications, including part orientation and tape sizes, please refer to our Tape and Reel Packaging Specifications Brochure, BRD8011/D.

# MUR1510G, MUR1515G, MUR1520G, MUR1540G, MUR1560G, MURF1560G, SUR81520G, SUR81560G

## PACKAGE DIMENSIONS

### TO-220 TWO-LEAD CASE 221B-04 ISSUE F

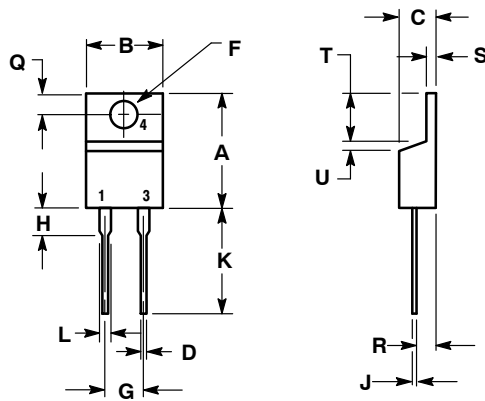

- NOTES:  
1. DIMENSIONING AND TOLERANCING PER ANSI Y14.5M, 1982.  
2. CONTROLLING DIMENSION: INCH.

DIM	INCHES		MILLIMETERS	
	MIN	MAX	MIN	MAX
A	0.595	0.620	15.11	15.75
B	0.380	0.405	9.65	10.29
C	0.160	0.190	4.06	4.82
D	0.025	0.039	0.64	1.00
F	0.142	0.161	3.61	4.09
G	0.190	0.210	4.83	5.33
H	0.110	0.130	2.79	3.30
J	0.014	0.025	0.36	0.64
K	0.500	0.562	12.70	14.27
L	0.045	0.060	1.14	1.52
Q	0.100	0.120	2.54	3.04
R	0.080	0.110	2.04	2.79
S	0.045	0.055	1.14	1.39
T	0.235	0.255	5.97	6.48
U	0.000	0.050	0.000	1.27

- STYLE 1:  
PIN 1: CATHODE  
2. N/A  
3. ANODE  
4. CATHODE

### TO-220 FULLPAK, 2-LEAD CASE 221AG ISSUE A

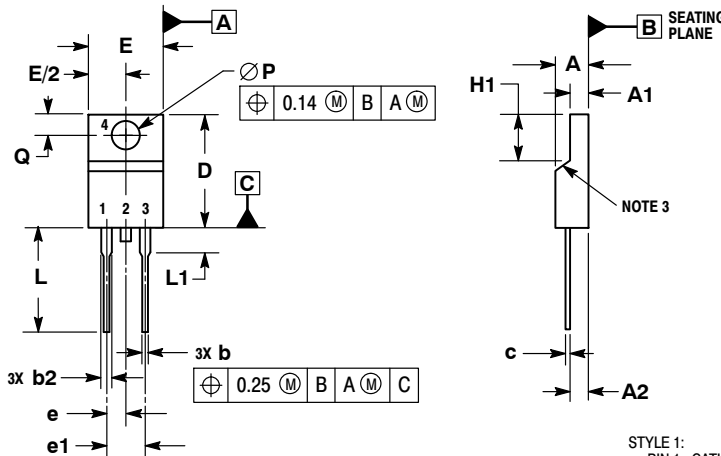

- NOTES:  
1. DIMENSIONING AND TOLERANCING PER ASME Y14.5M, 1994.  
2. CONTROLLING DIMENSION: MILLIMETERS.  
3. CONTOUR UNCONTROLLED IN THIS AREA.  
4. DIMENSIONS D AND E DO NOT INCLUDE MOLD FLASH AND GATE PROTRUSIONS. MOLD FLASH AND GATE PROTRUSIONS NOT TO EXCEED 0.13 PER SIDE. THESE DIMENSIONS ARE TO BE MEASURED AT OUTERMOST EXTREME OF THE PLASTIC BODY.  
5. DIMENSION b2 DOES NOT INCLUDE DAMBAR PROTRUSION. LEAD WIDTH INCLUDING PROTRUSION SHALL NOT EXCEED 2.00.

DIM	MILLIMETERS	
	MIN	MAX
A	4.30	4.70
A1	2.50	2.90
A2	2.50	2.90
b	0.54	0.84
b2	1.10	1.40
c	0.49	0.79
D	14.22	15.88
E	9.65	10.67
e	2.54 BSC	
e1	5.08 BSC	
H1	5.97	6.48
L	12.70	14.73
L1	---	2.80
P	3.00	3.40
Q	2.80	3.20

- STYLE 1:  
PIN 1: CATHODE  
2. N/A  
3. ANODE

ON Semiconductor and are registered trademarks of Semiconductor Components Industries, LLC (SCILLC). SCILLC owns the rights to a number of patents, trademarks, copyrights, trade secrets, and other intellectual property. A listing of SCILLC's product/patent coverage may be accessed at [www.onsemi.com/site/pdf/Patent-Marking.pdf](http://www.onsemi.com/site/pdf/Patent-Marking.pdf). SCILLC reserves the right to make changes without further notice to any products herein. SCILLC makes no warranty, representation or guarantee regarding the suitability of its products for any particular purpose, nor does SCILLC assume any liability arising out of the application or use of any product or circuit, and specifically disclaims any and all liability, including without limitation special, consequential or incidental damages. "Typical" parameters which may be provided in SCILLC data sheets and/or specifications can and do vary in different applications and actual performance may vary over time. All operating parameters, including "Typicals" must be validated for each customer application by customer's technical experts. SCILLC does not convey any license under its patent rights nor the rights of others. SCILLC products are not designed, intended, or authorized for use as components in systems intended for surgical implant into the body, or other applications intended to support or sustain life, or for any other application in which the failure of the SCILLC product could create a situation where personal injury or death may occur. Should Buyer purchase or use SCILLC products for any such unintended or unauthorized application, Buyer shall indemnify and hold SCILLC and its officers, employees, subsidiaries, affiliates, and distributors harmless against all claims, costs, damages, and expenses, and reasonable attorney fees arising out of, directly or indirectly, any claim of personal injury or death associated with such unintended or unauthorized use, even if such claim alleges that SCILLC was negligent regarding the design or manufacture of the part. SCILLC is an Equal Opportunity/Affirmative Action Employer. This literature is subject to all applicable copyright laws and is not for resale in any manner.

## PUBLICATION ORDERING INFORMATION

**LITERATURE FULFILLMENT:**  
Literature Distribution Center for ON Semiconductor  
P.O. Box 5163, Denver, Colorado 80217 USA  
Phone: 303-675-2175 or 800-344-3860 Toll Free USA/Canada  
Fax: 303-675-2176 or 800-344-3867 Toll Free USA/Canada  
Email: [orderlit@onsemi.com](mailto:orderlit@onsemi.com)

**N. American Technical Support:** 800-282-9855 Toll Free  
USA/Canada  
**Europe, Middle East and Africa Technical Support:**  
Phone: 421 33 790 2910  
**Japan Customer Focus Center**  
Phone: 81-3-5817-1050

**ON Semiconductor Website:** [www.onsemi.com](http://www.onsemi.com)  
**Order Literature:** <http://www.onsemi.com/orderlit>  
For additional information, please contact your local Sales Representative



# Mouser Electronics

Authorized Distributor

Click to View Pricing, Inventory, Delivery & Lifecycle Information:

[ON Semiconductor:](#)

[MUR1510G](#) [MUR1515G](#) [MUR1520G](#) [MUR1540G](#) [MUR1560G](#) [MURF1560G](#)