



HIGH PERFORMANCE
MICRO-CONNECTORS

DMM SERIES **Micro D-Mix™**
METAL RECTANGULAR CONNECTORS

NICOMATIC

MANUFACTURER & DESIGNER OF INTERCONNECT SOLUTIONS



CONTENT

CLASSIC DMM

For wire/wire, wire/PCB, PCB/PCB
with low frequency contacts only

ON CABLE	10
STRAIGHT PCB	11
RIGHT ANGLE PCB	13

MY DMM

For wire/wire, wire/PCB, PCB/PCB, front and rear panel
mixed-layout

ON CABLE	15
STRAIGHT PCB & SMT	18
RIGHT ANGLE PCB & SMT	20
INSERT ARRANGEMENTS	24

EXCLUSIVE DMM

Get the maximum technical possibilities

RANGE CAPABILITIES	27
--------------------------	----

ACCESSORIES

DMM MONO BACKSHELLS	28
DMM SPLIT BACKSHELLS	30

CABLE ASSEMBLY TOOLS

LOW FREQUENCY (LF) CONTACTS	33
HIGH POWER (HP) CONTACTS	36
HIGH FREQUENCY (HF) CONTACTS	39

PANEL MOUNT INFO

SPECIFIC DEVELOPMENTS



INTRODUCTION



DMM Series **Micro D-Mix™**

Defence and aerospace systems require high levels of performance in harsh environments, space saving and flexibility for the design.

DMM series has been developed to meet these needs.

All series are compliant or exceed MIL-DTL-83513G and are dedicated to cable and Printed Circuit Board applications.

NICOMATIC reinvents the Micro-D concept with a full modular and hybrid range

- 2mm pitch, from 1 to 4 rows, from 2 to 120 contacts shell size
- I/O connector, board to board, board to cable & cable to cable versions
 - Low frequency (LF): 3A
 - High frequency (HF): 6GHz
 - High power (HP): 5/8/10/15/20A

Application examples

FRONT PANEL

Cable / Cable

REAR PANEL

Cable rear mounting

Right angle rear mounting

Straight rear mounting

WIRE / WIRE

PCB / PCB

Straight / Right angle

Right angle/ Right angle PCB extension

Straight / Straight

PCB / WIRE

Straight SMT/cable

Right angle / cable card edge

Right angle / cable

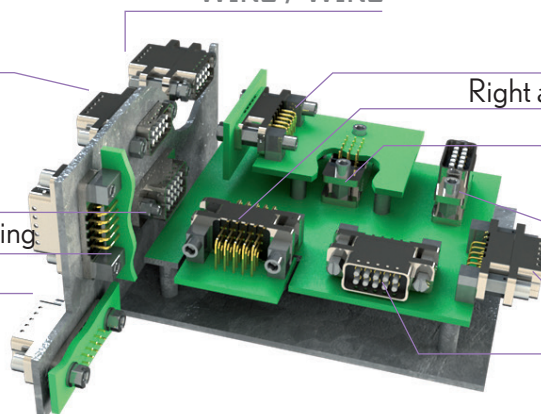

MAIN BENEFITS

- **Saves space** = Low profile, high density package & small footprint
- **Full modularity** = Signal, power & coax contacts
- **Easy maintenance** = Removable crimp contact
- **High flexibility** = Front / Rear panel mount, Straight / 90°, Cable / PCB
- **Short lead-time** = Fast availability vs. Micro-D, low MOD
- **Reliability** = According to MIL-DTL-83513G



Classic DMM

Classic DMM series: LF contacts, for harness applications or Printed Circuit Board. Available in most popular shell sizes from the market, these standard connectors are easy to choose and fast to deliver.

- Most popular Micro-D shell sizes
- LF contacts
- From 2 to 3 rows, 10 to 90 LF contacts
- Easy to choose, Fast to deliver

More than **200**
configuration possibilities

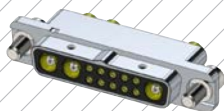

My DMM

My DMM series: LF, HF, HP or hybrid connectors, a range based on multi-contact arrangements, offering free positioning with pre-defined shell sizes. More than 60 fixing hardware options are available for easy integration. This series offers custom design possibilities with the advantage of an off-the-shelf product.

- Wider range to fit your design
- Mixed layout
- From 1 to 4 rows, 4 to 120 LF contacts, 1 to 30
- Easy to customize, easy to get
- Panel mounting, racking and locking

More than **20 000**
configuration possibilities



Exclusive DMM

Exclusive DMM series: LF, HF, HP or mixed contacts of any size, any length. A much higher number of arrangements is possible. The number of rows can be changed according to application constraints. These bespoke connectors optimize space and weight savings.

- Bespoke DMM for unique space constraints
- Shell size selection
- Millions of possible designs

More than
2 million
configuration possibilities

TECHNICAL DATA



CONTEXT

THIS SPECIFICATION COVERS PERFORMANCE REQUIREMENTS FOR NICOMATIC DMM CONNECTORS IN COMPLIANCE WITH MIL-DTL-83513G

REQUIREMENTS

ELECTRICAL PERFORMANCE REQUIREMENTS

■ Signal Low Frequency contacts (LF)

Rated current	3A max@25°C / 2.2A max@85°C
Rated voltage (sea level)	200VRMS
Withstanding voltage (sea level)	600VRMS
Breakdown voltage (sea level)	800VRMS
Contact resistance (initial)	8.7mΩ max
Insulation resistance	5GΩ min

■ High Power contacts (HP)

Rated voltage	500 VRMS
Withstanding voltage	1500 VRMS
Rated Current	30A max@25°C / 20A max@85°C
Contact resistance (initial)	3mΩ max

■ High Frequency contacts (HF)

Impedance	50Ω – 75Ω
Insulation resistance	10 ⁶ MΩ@250VRMS
SWR (stationary wave ratio)	< 1.05 + 0.04 *f GHz
Frequency range	6GHz (depending on cable)
Insulation between 2 contacts	-100dB (depending on cable)

MECHANICAL REQUIREMENTS

■ Low Frequency contacts (LF)

Durability	500 cycles min
Contact engagement/separation force	2N max. / 0.2N min
Contact retention in insulator (initial)	10N min
Contact replacement in insulator	3 cycles (contact on cable without backpotting)

■ High Power / High Frequency contacts

Durability	500 cycles min
Contact engagement/separation force	2N max / 0.5N min
Secure overlapping	1.30mm
Contact replacement in insulator	5 cycles (contact on cable without backpotting)

ENVIRONMENTAL REQUIREMENTS

Temperature range	From -55°C to +125°C. Complies with PbFree reflow T° profile
Vibration severity	10 to 2000Hz / 15g / 3 axis / 12 cycles per axis. (no signal interruption > than 1 µs)
Shock severity	100g for 6 ms sawtooth. (no signal interruption > than 1 µs)
Salt spray	48h, 5% NaCl

MATERIAL

■ Shell

Aluminum 6061 type alloy - Chemical Nickel plating 10µm

■ Insert

Special PPS (Polyphenylene Sulfide Fibreglass filled thermoplastic) UL 94-V0

Radiation resistance / No humidity absorption / Oxygen free

Note: PPS characteristics are recognized for space applications

Insert retention: 50 pounds per sq. inch

■ Fixing Hardware

Jackscrew: Passivated Stainless steel 300 series

M2.5 Max. torque 0.30N.m (circlip version: D53) / 0.40 N.m (others)

■ Contacts

Low Frequency contacts: Ni + Au > 1.27µm (depending on contact)

Insulator: PTFE (HF contacts only)

Retaining clip: Be/Cu Ni plated 3µm (contacts on cable only)

IMPORTANT NOTICE

According to the routines test other than MIL our technical features for DMM Micro-connectors reach a higher result.

Please contact technic@nicomatic.fr for more information.

For example:

- LF: up to 5A max.@ 25°C

- HF: up to 11GHz

- HP: up to 30A

- Mechanical operations: up to 5 000 cycles

- Application with LVDS signal @ 400MHz, impedance 100 Ohm

- High speed: USB, 1Gb/s Ethernet...

CONNECTOR SPACING

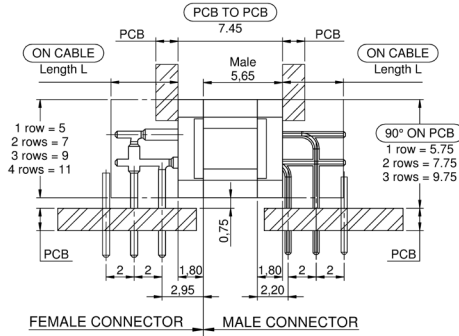

Shell type	Length L	
	Female	Male
Low profile C / S	2,30	2,20
Medium profile CP / SP	4,80	4,35
High profile CL / SL	7,80	7,35

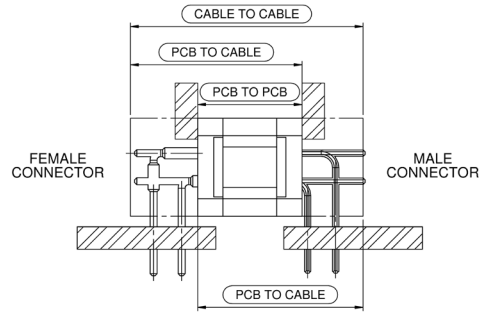

MALE CONNECTOR	FEMALE CONNECTOR	FEMALE CONNECTOR				
		PCB	CABLE			
			STRAIGHT	90°	C / S	CP / SP
		STRAIGHT	90°	C / S	CP / SP	CL / SL
	PCB	STRAIGHT	90°			
	CABLE					

CONNECTOR MARKING

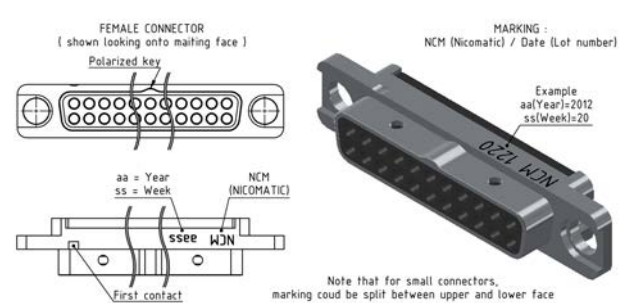
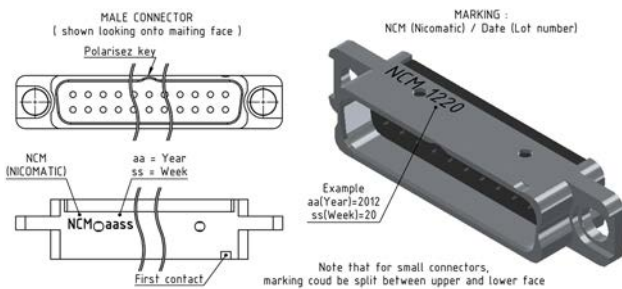



Classic DMM



- HIGH RELIABILITY
- COST EFFECTIVE
- EASY TO CHOOSE, FAST TO DELIVER
- MOST POPULAR MICRO-D SHELL SIZES



ON CABLE

PART NUMBERING.....	10
DIMENSION.....	10



STRAIGHT PCB

PART NUMBERING.....	11
DIMENSIONS.....	12

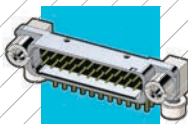

RIGHT ANGLE PCB

PART NUMBERING.....	13
DIMENSIONS.....	13

Classic DMM series: LF contacts, for harness applications or printed circuit boards. Available in most popular shell sizes from the market, these standard connectors are easy to choose and fast to deliver with affordable price.



ON CABLE

- LOW FREQUENCY CONTACTS
- AWG22 / 24-28
- REMOVABLE CONTACTS

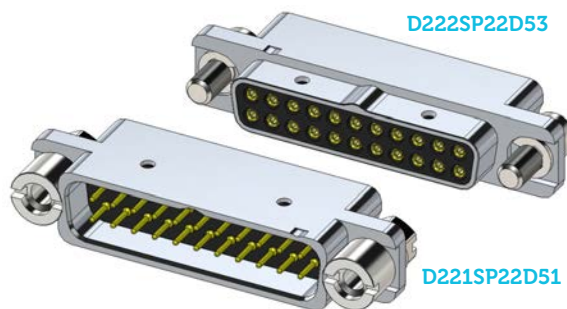

HOW TO ORDER ?

PART NUMBERING					
Classic DMM ON CABLE					
DMM	Series	Gender	LF contact type	Contact Layout	Fixing Hardware
D	22 - from 10 to 38 pins	1 - male	CP - for #22 AWG	10	D53 jackscrew for female connector
	32 - from 51 to 90 pins	2 - female	SP - for #24-28 AWG	16	
				22	
				26	
				32	
				38	
MATING D53 > D51				51	D51 jackpost for male connector
				90	



DIMENSIONS

	Number of LF contacts	Gender	A	B	C	E	G
	10	M	8	18	23	7	10
		F	8	18	23	7	10
	16	M	14	24	29	7	10
		F	14	24	29	7	10
	22	M	20	30	35	7	10
		F	20	30	35	7	10
	26	M	24	34	39	7	10
		F	24	34	39	7	10
	32	M	30	40	45	7	10
		F	30	40	45	7	10
	38	M	36	46	51	7	10
		F	36	46	51	7	10
	51	M	32	42	47	9	10
		F	32	42	47	9	10
	90	M	58	68	73	9	10
		F	58	68	73	9	10

Dimensions

Male

Female

d : pitch :2mm
Potting area:
male 2.15mm
female 2.50mm

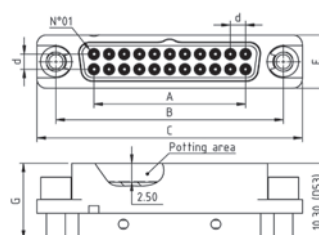
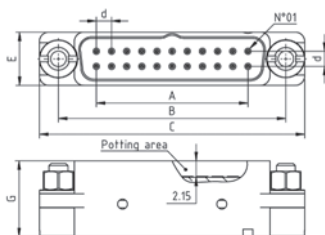

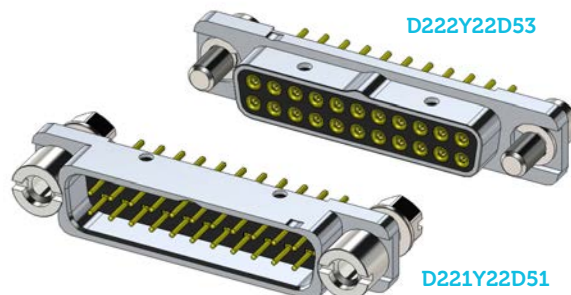

STRAIGHT PCB

LOW FREQUENCY CONTACTS







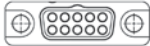
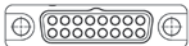
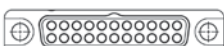

HOW TO ORDER ?

PART NUMBERING						
Classic DMM STRAIGHT PCB						
DMM	Series	Gender	LF contact type	Contact Layout	Fixing Hardware	
D	22 - from 10 to 38 pins	1 - male	Y - for PCB 1.6mm	10	D53 jackscrew PCB for female	 size: M2.5
	32 - from 51 to 90 pins	2 - female	YL - for PCB 3.2mm	16		
				22		
				26	D51 jackpost PCB 1.6mm for male	
				32		
				38	D51L jackpost PCB ≤ 3.2mm for male	
				51		
				90		

MATING
D 53 > D51
> D51L

DIMENSIONS

	Number of LF contacts	Gender	A	B	C	E	G
	10	M	8	18	23	7	5.65
		F	8	18	23	7	5.20
	16	M	14	24	29	7	5.65
		F	14	24	29	7	5.20
	22	M	20	30	35	7	5.65
		F	20	30	35	7	5.20
	26	M	24	34	39	7	5.65
		F	24	34	39	7	5.20
	32	M	30	40	45	7	5.65
		F	30	40	45	7	5.20
	38	M	36	46	51	7	5.65
		F	36	46	51	7	5.20
	51	M	32	42	47	9	5.65
		F	32	42	47	9	5.20
	90	M	58	68	73	9	5.65
		F	58	68	73	9	5.20



Dimensions

Male

Female

d : pitch :2mm

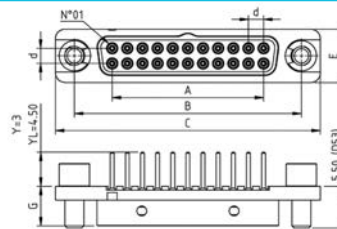
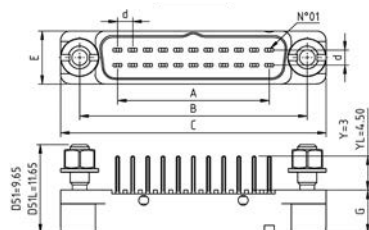

PCB Layout

Straight PCB

220 Y-YL

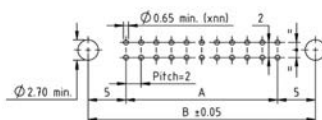

320 Y-YL

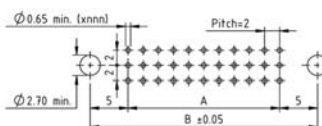

RIGHT ANGLE PCB

- LOW FREQUENCY CONTACTS
- ONLY MALE CONNECTORS

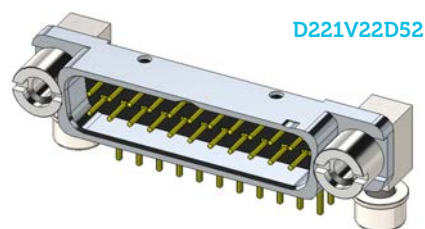

→ HOW TO ORDER ?

PART NUMBERING						
Classic DMM RIGHT ANGLE PCB						
DMM	Series	Gender	LF contact type	Contact Layout	Fixing Hardware	
D	22 - from 10 to 38 pins	1 - male	V - for PCB 1.6mm	10	For 2 rows	
	32 - from 51 to 90 pins		VL - for PCB 3.2mm	16	D52 jackpost PCB 1.6mm	
			22	D52M jackpost PCB 2.4mm		
			26	D52M jackpost PCB 2.4mm		
			32	D52L jackpost PCB 3.2mm		
			38	D52L jackpost PCB 3.2mm		
			51	90	For 3 rows	
					D57 jackpost PCB 1.6mm	
					D57M jackpost PCB 2.4mm	
					D57L jackpost PCB 3.2mm	

MATING

- D 53 > D52M
- > D52L
- > D57L
- > D57M

→ DIMENSIONS

	Number of LF contacts	Gender	A	B	C	E	G
	10	M	8	18	23	7.75	5.65
	16	M	14	24	29	7.75	5.65
	22	M	20	30	35	7.75	5.65
	26	M	24	34	39	7.75	5.65
	32	M	30	40	45	7.75	5.65
	38	M	36	46	51	7.75	5.65
	51	M	32	42	47	9.75	5.65
	90	M	58	68	73	9.75	5.65



Dimensions

Male

d : pitch :2mm

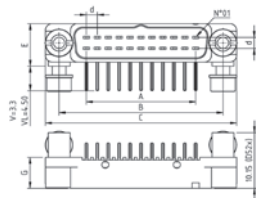

PCB Layout

Male

220 V-VL

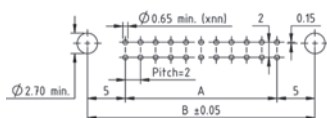

320 V-VL

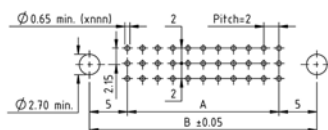



MY DMM



- HIGH RELIABILITY
- EASY TO CUSTOMIZE, EASY TO GET
- WIDER RANGE TO FIT YOUR DESIGN
- MIXED LAYOUT
- RACKING, LOCKING, PANEL MOUNT

INSERT ARRANGEMENTS 16

ON CABLE

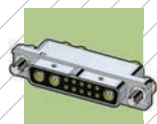

PART NUMBERING	18
DIMENSIONS	19

STRAIGHT PCB & SMT



PART NUMBERING	20
DIMENSIONS	21

RIGHT ANGLE PCB & SMT

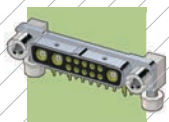

PART NUMBERING	22
DIMENSIONS	24

MyDMM series: LF, HF, HP or hybrid connectors, a range based on multi-contact arrangements, offering free positioning with pre-defined shell sizes. More than 60 fixing hardware options are available for easy integration. This series offers custom design possibilities with the advantage of an off-the-shelf product.





INSERT ARRANGEMENTS

➔ DISCOVER ALL INSERT ARRANGEMENTS

ROWS	Shell size	Number of LF contacts	Number of HP / HF contacts	View
1 ROW	4	4	0	
2 ROWS	10	10	0	
		6	1	
2 ROWS	16	2	2	
		16	0	
		12	1	
		8	2	
		4	3	
2 ROWS	22	0	4	
		22	0	
		18	1	
		14	2	
2 ROWS	26	10	3	
		6	4	
		2	5	
		26	0	
		22	1	
		18	2	
2 ROWS	26	14	3	
		10	4	
		6	5	
		2	6	
		32	0	
		28	1	
		24	2	
2 ROWS	32	20	3	
		16	4	
		12	5	
		8	6	
		4	7	
		0	8	
		38	0	
2 ROWS	38	34	1	
		30	2	
		26	3	
		22	4	
		18	5	
		14	6	
		10	7	
		6	8	
		2	9	
		3 ROWS	51	
47	1			
43	2			
39	3			
35	4			
31	5			
27	6			
23	7			
19	8			
15	9			
11	10			
7	11			
3	12			

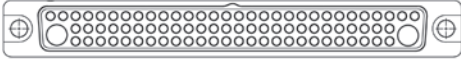
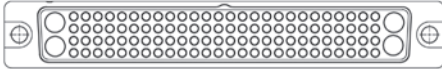
ROWS	Shell size	Number of LF contacts	Number of HP / HF contacts	View
3 ROWS	90	90	0	
		86	1	
		82	2	
		78	3	
		74	4	
		70	5	
		66	6	
		62	7	
		58	8	
		54	9	
		50	10	
		46	11	
		42	12	
		38	13	
		34	14	
		30	15	
		26	16	
		22	17	
		18	18	
		14	19	
		10	20	
		6	21	
2	22			
4 ROWS	120	120	0	
		112	2	
		104	4	
		96	6	
		88	8	
		80	10	
		72	12	
		64	14	
		56	16	
		48	18	
		40	20	
		32	22	
		24	24	
		16	26	
		8	28	
		0	30	

HOW TO ORDER MY DMM IN 3 STEPS

- Select the number of pins according to table above
- Arrange HP/HF contacts positioning according to your need (top right, top left, on both sides)
- Complete your part number for each series:

- on cable page 18
- PCB straight & SMT page 20
- PCB right angle & SMT page 22

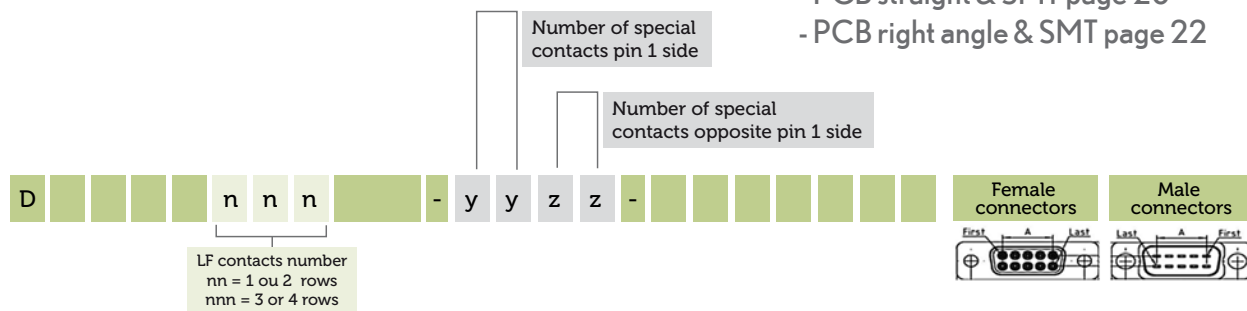



ON CABLE

- LOW FREQUENCY (LF), HIGH FREQUENCY (HF), HIGH POWER (HP) CONTACTS
- RACKING OR LOCKING HARDWARE
- REMOVABLE CONTACTS
- PANEL MOUNT



HOW TO ORDER ?

PART NUMBERING							
MY DMM ON CABLE							
DMM	Series	Gender	LF contact type	LF contact Layout	Fixing Hardware	HF / HP contact Layout	HF / HP contact type
				Number of contacts	Screw locking	Number of contacts	Not applicable for 1 row
D	10 - 1 row	1 - male	CP	From 2 to 120	D53 jackscrow	From 1 to 30 Refer to p.16/17	HIGH POWER For male connectors 3305 - 5Amp - AWG20 3308 - 8Amp - AWG18 3310 - 10Amp - AWG16-18-20 3315 - 15Amp - AWG14 3320 - 20Amp - AWG12 For female connectors 4305 - 5Amp - AWG20 4308 - 8Amp - AWG18 4310 - 10Amp - AWG16-18-20 4315 - 15Amp - AWG14 4320 - 20Amp - AWG12 HIGH FREQUENCY COAX For male connectors 1312 - for cable Ø 1.2mm 1320 - for cable Ø 2mm 1324 - for cable Ø 2.4mm 1326 - for cable Ø 2.6mm 1347 - for cable type UT47 1385 - for cable type UT85 For female connectors 2312 - for cable Ø 1.2 mm 2320 - for cable Ø 2 mm 2324 - for cable Ø 2.4 mm 2326 - for cable Ø 2.6 mm 2347 - for cable type UT47 2385 - for cable type UT85
	22 - 2 rows	2 - female	SP	Refer to p.16/17	D51 jackpost Front panel 1.5mm		
	32 - 3 rows		EP		D51L jackpost Front panel 3.5 mm		
	42 - 4 rows		0 LF contacts* (for special configurations only)		D55D jackpost Rear panel 2mm		
					Rack locking		
					D63 guide pin Front panel 1.5mm		
					D64 guide socket Front panel 1.5mm		
					D64L guide socket Front panel 3.5mm		
					D65D guide socket Rear panel 2mm		

MATING

D 53 > D51
 > D51L
 > D55D

D63 > D64
 > D64L
 > D65D

For other panel thicknesses, please refer to Exclusive DMM page 27.

*In case of no LF contacts, please specify "00".



DIMENSIONS

Example with all LF arrangements. Mixed-layout also possible.

	Number of LF contacts	Gender	A	B	C	E	G
	4	M	6	16	21	5	10
		F	6	16	21	5	10
	10	M	8	18	23	7	10
		F	8	18	23	7	10
	16	M	14	24	29	7	10
		F	14	24	29	7	10
	22	M	20	30	35	7	10
		F	20	30	35	7	10
	26	M	24	34	39	7	10
		F	24	34	39	7	10
	32	M	30	40	45	7	10
		F	30	40	45	7	10
	38	M	36	46	51	7	10
		F	36	46	51	7	10
	51	M	32	42	47	9	10
		F	32	42	47	9	10
	90	M	58	68	73	9	10
		F	58	68	73	9	10
	120	M	58	68	73	11	10
		F	58	68	73	11	10

Dimensions

d : pitch : 2mm
 D : pitch : 4mm
 Potting area:
 male 2.15mm
 female 2.50mm

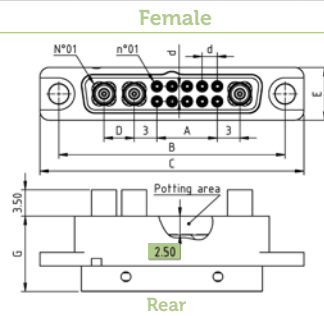
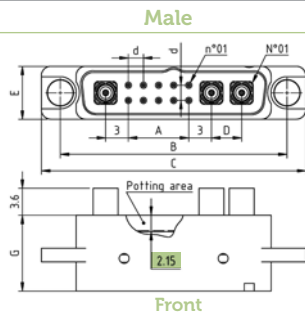

Panel cut

100 CP - SP - EP

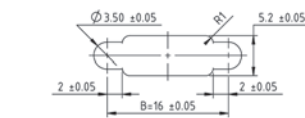
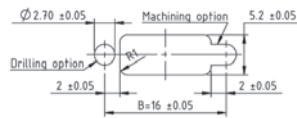

220 CP - SP - EP

Dimensions in mm :
 B = (yy+zz) x 4 + A + 10
 Bmax. = 68

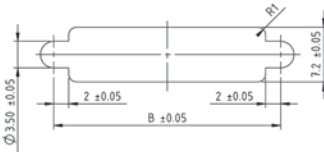
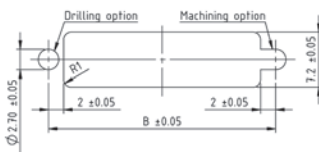

320 CP - SP - EP

Dimensions in mm :
 B = A + 10
 Bmax. = 68

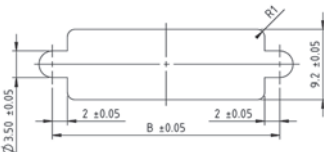
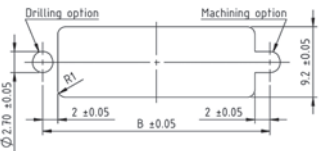

420 CP - SP - EP

Dimensions in mm :
 B = A + 10
 Bmax. = 68

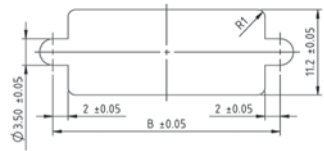
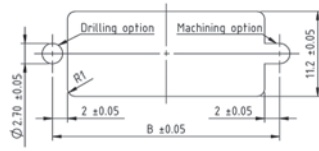

Panel cut is the same for male or female connectors

M = MALE | F = FEMALE | DIMENSIONS ARE IN MM





STRAIGHT PCB & SMT

- LF FREQUENCY (LF), HIGH FREQUENCY (HF), HIGH POWER (HP) CONTACTS
- RACKING OR LOCKING HARDWARE
- SMT LF CONTACTS AVAILABLE



➔ HOW TO ORDER ?

PART NUMBERING										
MY DMM STRAIGHT PCB										
DMM	Series	Gender	LF contact type	LF contact Layout	Fixing Hardware	HF / HP contact Layout	HF / HP contact type			
D	10 - 1 row	1 - male	Y for PCB 1.6mm	From 2 to 120	Screw locking D53 jackscrew	From 1 to 30	HIGH POWER For male connectors 3300 DMM for PCB 1.6mm 3300 45 for PCB 3.2mm For female connectors 4300 DMM for PCB 1.6mm 4300 45 for PCB 3.2mm HIGH FREQUENCY For male connectors 1300 DMM for PCB 1.6mm 1300 45 for PCB 3.2mm For female connectors 2300 DMM for PCB 1.6mm 2300 45 for PCB 3.2mm	Refer to p.16/17		
		2 - female	YL for PCB 3.2mm		D51 jackpost for PCB 1.6mm					
	22 - 2 rows	2 - female				D51L jackpost for PCB 2.4 to 3.2mm				
						D55D jackpost Rear panel 2mm / PCB 1.6mm				
	32 - 3 rows		T Straight SMT							
	42 - 4 rows		D 0 LF contacts* (for special configurations only)							
						Rack locking				
						D63 - guide pin for PCB 1.6mm				
						D64 - guide socket for PCB 1.6 mm				
						D64L - guide socket for PCB 2.4 to 3.2mm				
					D65D - guide socket Rear panel 2 mm					

MATING

D 53 > D51
> D51L
> D55D

D63 > D64
> D64L
> D65D

*In case of no LF contacts, please specify "00".



DIMENSIONS

Example with all LF arrangements. Mixed-layout also possible.

	Number of LF contacts	Gender	A	B	C	E	G
	4	M	6	16	21	5	5.65
		F	6	16	21	5	5.20
	10	M	8	18	23	7	5.65
		F	8	18	23	7	5.20
	16	M	14	24	29	7	5.65
		F	14	24	29	7	5.20
	22	M	20	30	35	7	5.65
		F	20	30	35	7	5.20
	26	M	24	34	39	7	5.65
		F	24	34	39	7	5.20
	32	M	30	40	45	7	5.65
		F	30	40	45	7	5.20
	38	M	36	46	51	7	5.65
		F	36	46	51	7	5.20
	51	M	32	42	47	9	5.65
		F	32	42	47	9	5.20
	90	M	58	68	73	9	5.65
		F	58	68	73	9	5.20
	120	M	58	68	73	11	5.65
		F	58	68	73	11	5.20

Dimensions

d : pitch : 2mm
D : pitch : 4mm

Male

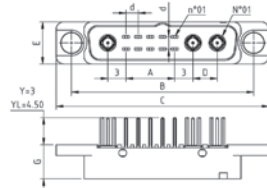

Female

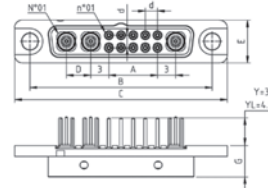

PCB layout / Rear panel cut

100 Y - YL

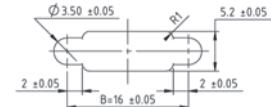
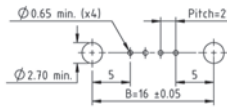

100 T | 220 T

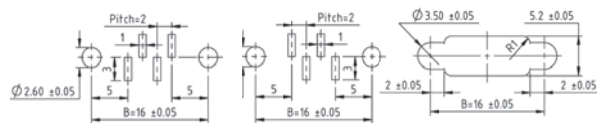

Dimensions in mm ;
B = (yy+zz) x 4 + A + 10
Bmax. = 68

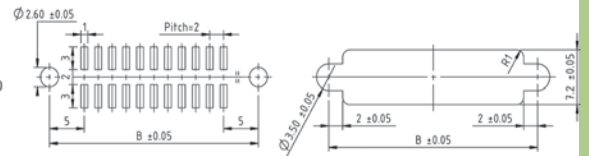

220 Y - YL

Dimensions in mm ;
B = (yy+zz) x 4 + A + 10
Bmax. = 68

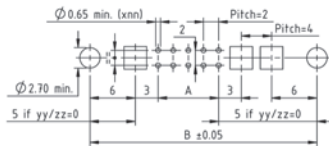

HF

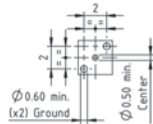

HP

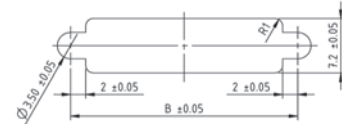
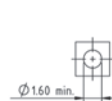

320 Y - YL

Dimensions in mm ;
B = A + 10
Bmax. = 68

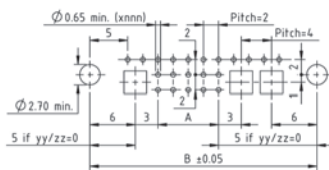

HF

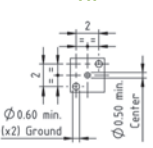

HP

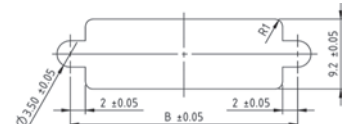
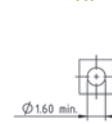

420 Y - YL

Dimensions in mm ;
B = A + 10
Bmax. = 68

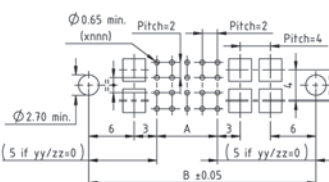

HF

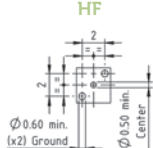

HP

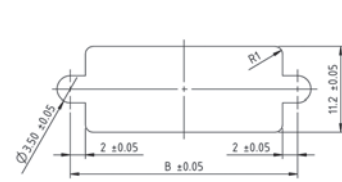
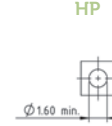



RIGHT ANGLE PCB & SMT











- LOW FREQUENCY (LF), HIGH FREQUENCY (HF), HIGH POWER (HP) CONTACTS
- MALE / FEMALE FIXING INTERCHANGEABLE
- RACKING OR LOCKING HARDWARE
- SMT LF CONTACTS AVAILABLE



D222V10D52M-0201-2400DMM

➔ HOW TO ORDER ?

D221V10D53-0201-1400DMM

PART NUMBERING								
MY DMM RIGHT ANGLE PCB LOCKING								
DMM	Series	Gender	LF contact type	LF contact Layout	Fixing Hardware	HF /HP contact Layout	HF /HP contact type	
D	10 - 1 row	1 - male	V for PCB 1.6mm	From 2 to 90 Refer to p.16/17	Screw locking		From 1 to 15 Refer to p.16/17	
		22-2 rows	2 - female		VL for PCB 3.2mm	D53 size: M2.5 jackscrew inner hexagonal 		
		32 - 3 rows				For 1 row connector		
				R Right Angle		D60 jackpost for PCB 1.6mm		HIGH POWER For male connectors 3400 DMM for PCB 1.6mm
				SMT		D60M jackpost for PCB 2.4mm		For female connectors 4400 DMM for PCB 1.6mm
				D 0 LF contacts* (for special configurations only)		D62MD jackpost rear panel 2mm PCB 2.4mm		HIGH FREQUENCY For male connectors 1400 DMM for PCB 1.6mm
						For 2 rows connector		For female connectors 2400 DMM for PCB 1.6mm
						D52 jackpost for PCB 1.6mm		
						D52M jackpost for PCB 2.4mm		
						D56MD jackpost rear panel 2mm PCB 2.4mm		
						For 3 rows connector		
						D57 jackpost for PCB 1.6mm		
					D57M jackpost for PCB 2.4mm			
					D59MD jackpost rear panel 2mm PCB 2.4mm			

MATING
D53 > ALL

*In case of no LF contacts, please specify "00".

➔ HOW TO ORDER ?

PART NUMBERING							
MY DMM RIGHT ANGLE PCB RACKING							
DMM	Series	Gender	LF contact type	Signal contact Layout	Fixing Hardware	Coax / Power contact Layout	Coax / Power contact type
D	10 - 1 row	1 - male	V for PCB 1.6mm	From 2 to 90	Rack locking D63 size: M2.5 guide pin for PCB 1.6mm	From 1 to 15 Refer to p.16/17	HIGH POWER For male connectors 3400 DMM for PCB 1.6mm For female connectors 4400 DMM for PCB 1.6mm HIGH FREQUENCY For male connectors 1400 DMM for PCB 1.6mm For female connectors 2400 DMM for PCB 1.6mm
	22-2 rows	2 - female	VL for PCB 3.2mm	Refer to p.16/17	For 1 row connector D71 guide socket for PCB 1.6mm		
	32 - 3 rows		R Right angle SMT D for 0 LF contacts* (for special configurations only)		D71M guide socket for PCB 2.4mm		
					D73MD guide socket rear panel 2mm / PCB 2.4mm		
					For 2 rows connector D68 guide socket for PCB 1.6mm		
					D68M guide socket for PCB 2.4mm		
					D74MD guide socket rear panel 2mm / PCB 2.4mm		
					For 3 rows connector D72 guide socket for PCB 1.6mm		
					D72M guide socket for PCB 2.4 mm		
					D75MD guide socket rear panel / PCB 2.4mm		

MATING

D63 > ALL

*In case of no LF contacts, please specify "00".

M = MALE | F = FEMALE | DIMENSIONS ARE IN MM

NICOMATIC



RIGHT ANGLE PCB & SMT



DIMENSIONS

Example with all LF arrangements. Mixed-layout also possible.

	Number of LF contacts	Gender	A	B	C	E	G
	4	M	6	16	21	5.75	5.65
		F	6	16	21	5.75	5.20
	10	M	8	18	23	7.75	5.65
		F	8	18	23	7.75	5.20
	16	M	14	24	29	7.75	5.65
		F	14	24	29	7.75	5.20
	22	M	20	30	35	7.75	5.65
		F	20	30	35	7.75	5.20
	26	M	24	34	39	7.75	5.65
		F	24	34	39	7.75	5.20
	32	M	30	40	45	7.75	5.65
		F	30	40	45	7.75	5.20
	38	M	36	46	51	7.75	5.65
		F	36	46	51	7.75	5.20
	51	M	32	42	47	9.75	5.65
		F	32	42	47	9.75	5.20
	90	M	58	68	73	9.75	5.65
		F	58	68	73	9.75	5.20

Dimensions

d : pitch : 2mm
D : pitch : 4mm

Male

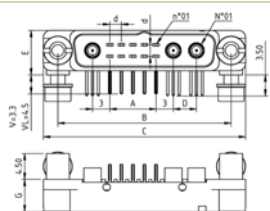

Female

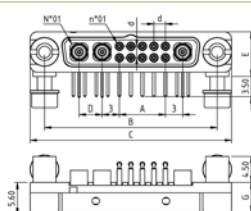

PCB layout

100 V - VL - D

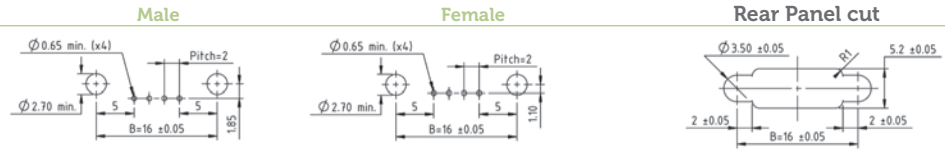

220 V - VL - D (no LF)

Male only

HF

HP

Dimensions in mm :

$B = (yy+zz) \times 4 + A + 10$
 $B_{max} = 68$

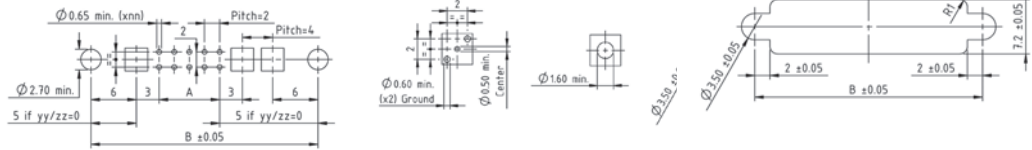

320 V - VL - D (no LF)

Male only

HF

HP

Dimensions in mm :

$B = A + 10$
 $B_{max} = 68$

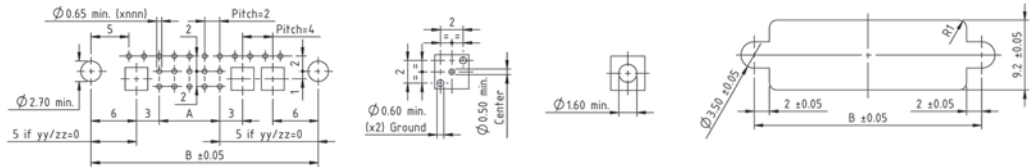

100 R

Male

Female

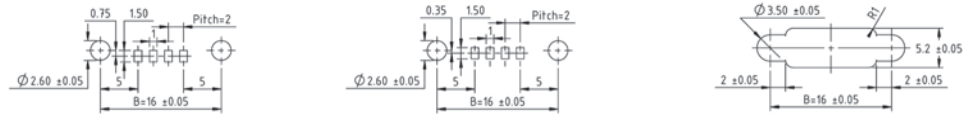

220 R

Dimensions in mm :

$A = nn - 2$
 $B = A + 10$
 $B_{max} = 68$

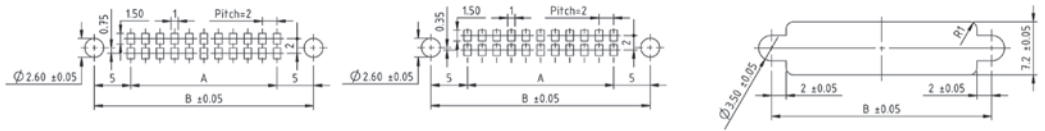

320 R

No female

Dimensions in mm :

$A = (nn \times 2) / 3 - 2$
 $B = A + 10$
 $B_{max} = 68$





EXCLUSIVE DMM UPON REQUEST ONLY

- HIGH RELIABILITY
- MILLIONS OF POSSIBLE DESIGNS
- BESPOKE DMM FOR UNIQUE CONSTRAINTS

RANGE CAPABILITIES

SHELL PROFILES	27
INSERT ARRANGEMENTS	27
CONTACT TYPES	27
HARNESSES	27
HOW TO ORDER	27

Exclusive DMM series: LF, HF, HP or mixed contacts of any size, any length. A higher number of arrangements is possible. The number of rows can be changed according to application constraints. These tailor-made connectors optimize space and weight savings.

EXCLUSIVE DMM UPON REQUEST ONLY*

SHELL PROFILES FOR CABLE

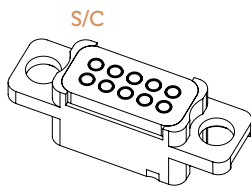

Low profile: 7.5/7.8mm

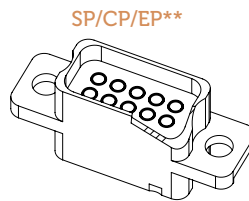

Medium profile: 10mm
** code for shell with special contacts only

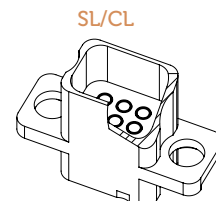

High profile: 13mm

INSERT ARRANGEMENTS

LF arrangements	Series	Profile	LF
	D100	○○○○	1 row 2 to 30 pins
	D220	○○○○ ○○○○	2 rows 4 to 60 pins
	D320	○○○○ ○○○○ ○○○○	3 rows 6 to 90 pins
	D420	○○○○ ○○○○ ○○○○ ○○○○	4 rows 8 to 120 pins

Mixed arrangements	Series	Profile	LF	HP/HF
	D220	○ ○○○○ ○	2 rows 2 to 56 pins	1 row 1 to 15 pins
	D320	○○○○○ ○○○○○	3 rows 3 to 86 pins	1 row 1 to 15 pins
	D420	○○○○○ ○ ○ ○○○○○ ○ ○	4 rows 4 to 112 pins	2 rows 2 to 30 pins
	D430	○○○○○ ○ ○ ○ ○○○○○ ○ ○ ○	4 rows 8 to 116 pins	2 rows 1 to 29 pins

CONTACT TYPES

DMM series	series	LF contact										HF contact				HP contact							
		PCB					On cable to crimp or to solder					PCB		Cable		PCB		Cable					
		Straight 1.6 / 3.2 mm		Right angle 1.6 / 3.2 mm		Straight SMT		Right angle SMT		AWG24-28	AWG22	AWG24-28	AWG22	AWG24-28	AWG22	Straight	Right angle	Straight crimp/solder	Right angle crimp/solder	Straight	Right angle	Straight crimp/solder	Right angle Crimp/solder
		Y	YL	V	VL	T	R	S	C	SP	CP	SL	CL	Straight	Right angle	Straight crimp/solder	Right angle crimp/solder	Straight	Right angle	Straight crimp/solder	Right angle Crimp/solder		
1 row	M	D101																					
	F	D102																					
2 rows	M	D221																					
	F	D222																					
3 rows	M	D321																					
	F	D322																					
4 rows	M	D421																					
	F	D422																					
4 rows	M	D431																					
	F	D432																					

□ Not available : contact us

C-S = Use with C-S shell type only

OPTIONS

- Backpotting available
- Harness with different cable configurations (length, type, color) and backpotting option
- Different fixing functions: panel/PCB thicknesses, reverse fixings, SMT...
- Different shells

HOW TO ORDER

Contact your local support

*Upon request connectors are configurable with a standard part numbering system and available in short leadtime. Contact us!



DMM MONO BACKSHELLS

Description

Range of accessories for mechanical and EMI 360° protection. The One-piece design has a very thin profile. It can be used with medium or long shell profiles.

Technical Features

- Aluminum 6061 type alloy – chemical nickel plating
- Available with elliptical or circular entry according to shell size
- Straight entry
- Entry can accept up to 12OLF / 30HP / 30HF / Mixed Layout
- Band option
- Shield termination is fast and reliable using banding tools

DMM-M2-L-18-P

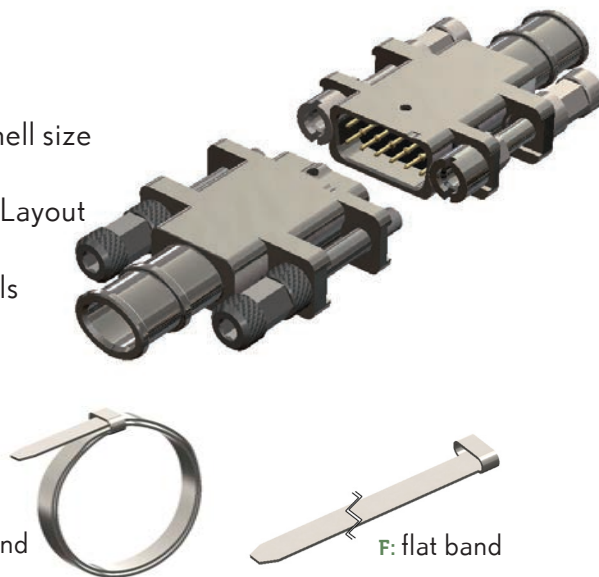

HOW TO ORDER ?

C: coiled band

F: flat band

DMM-Mn-y-xx-P-C					Optional
Series	Number of rows	Connector type	Distance between axis	P*	Band type
DMM-M = Mono	1	y = L for connectors with LF contacts only	16 - for 4 pins	P in standard	Select C or F
			18 - for 10 pins		
	2	y = M for connectors with mixed layout or with special contacts	24 - for 16 pins		
			30 - for 22 pins		
			34 - for 26 pins		
			40 - for 32 pins		
	3		46 - for 38 pins		
			42 - for 51 pins		
	4		68 - for 90 pins		
			68 - for 120 pins		

*option L = L instead of P in case of larger space needed for backpotting. (P for standard shell size - L for long shell size)

■ Connector

The Fixing hardware is delivered with the backshell.

When ordering the backshell, the connector's fixing hardware part number will be:

- DXX

Example: D222SP16DXX instead of D222SP16D53

■ Banding tool kit

- Flat Band PN: 17205
- Coiled Band PN: 17206
- Complete Kit PN: C17472
 - Manual banding tool instruction
 - Manual banding tool
 - Adjustment wrench
 - Rollover tool



Dimensions

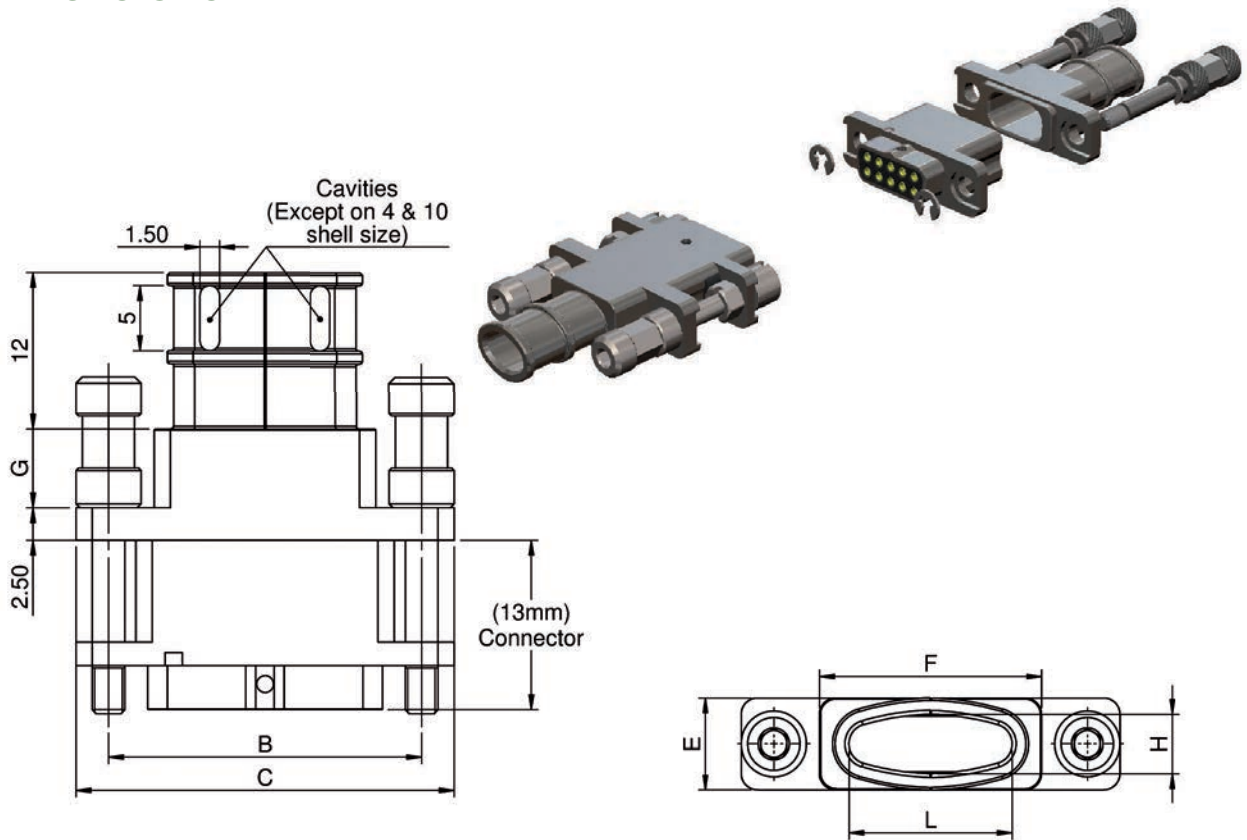

	SHELL SIZE	B	C	E	F	H	L		G	
							Y=L*	Y=M*	Y=L*	Y=M*
	10	18	23	7	11	4,5	5	7	5	7
	16	24	29	7	17	4,5	8	12	8	12
	22	30	35	7	23	4,5	11	16	11	16
	26	34	39	7	27	4,5	13	19	13	19
	32	40	45	7	33	4,5	16	23	16	23
	38	46	51	7	39	4,5	19	27	19	27
	51	42	47	9	36,8	6,5	17	24	18	26
	90	68	73	9	62,8	6,5	30	43	31	44
	120	68	73	11	62,8	8,5	29	43	31	44

L for connectors with LF contacts only - M for connectors with mixed layout or with special contacts



DMM SPLIT BACKSHELLS

Description

Range of accessories for mechanical and EMI 360° protection. The Classic Two-piece design provides a very easy and fast mounting and dismounting process. It can be used with all Nicomatic DMM series and all shell types.

Technical Features

- Aluminum 6061 type alloy - chemical nickel plating
- Available with elliptical or circular entry according to shell size
- Straight entry
- Entry can accept up to 120LF / 30HP / 30HF / Mixed Layout
- Band option
- Shield termination is fast and reliable using banding tools

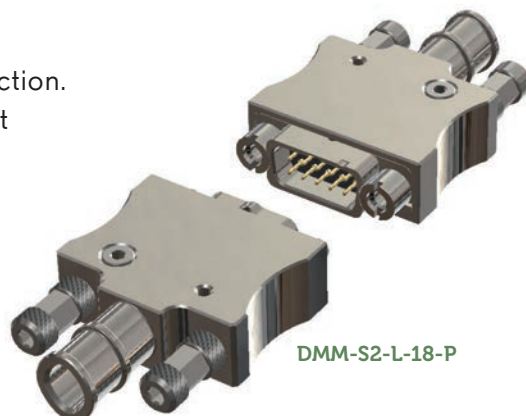

C: coiled band

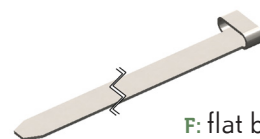

F: flat band

HOW TO ORDER ?

DMM-Sn-y-xx-P-C					Optional
Series	Number of rows	Connector type	Distance between axis	P*	Band type
DMM-S - Split	1	y = L for connectors with LF contacts only LF	16 - for 4 pins	P in standard	Select C or F
			18 - for 10 pins		
	24 - for 16 pins				
	30 - for 22 pins				
	34 - for 26 pins				
	40 - for 32 pins				
	46 - for 38 pins				
	42 - for 51 pins				
	68 - for 90 pins				
	68 - for 120 pins				
2	y = M for connectors with mixed layout or with special contacts	3			
4					

*option L = L instead of P in case of larger space needed for backpotting. (P for standard shell size - L for long shell size)

■ Connector

Backshell is delivered without fixing. You will have to order your DMM connector by replacing the fixing hardware digit: "Bxx" instead of "Dxx"

Example: D222SP16**B**53 instead of D222SP16**D**53

Please refer to DMM Catalogue

■ Banding tool kit

- Flat Band PN: 17205
- Coiled Band PN: 17206
- Complete Kit PN: C17472
 - Manual banding tool instruction
 - Manual banding tool
 - Adjustment wrench
 - Rollover tool

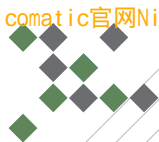

Dimensions

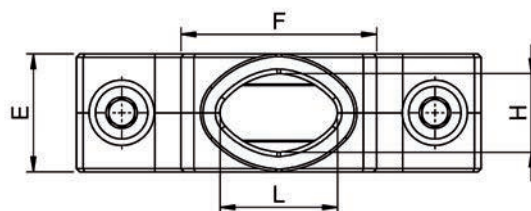
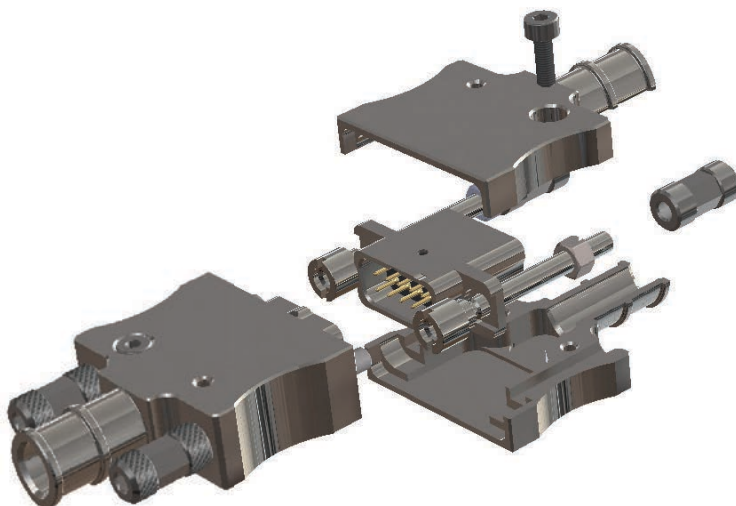
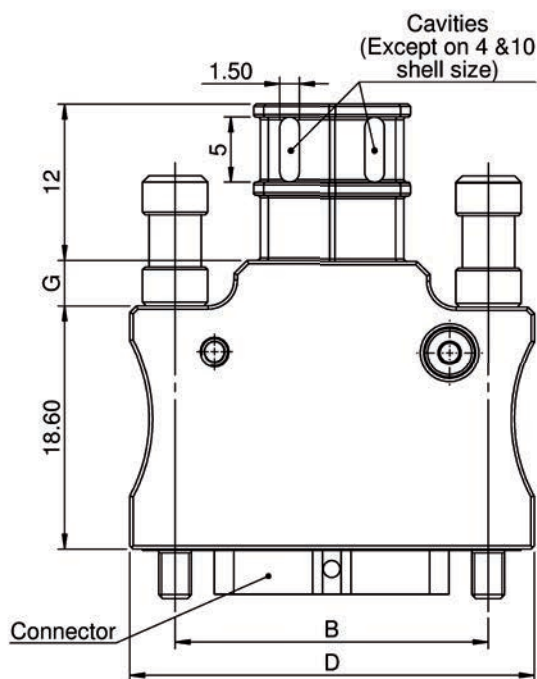

	SHELL SIZE	B	D	E	F	H	L		G	
							Y=L*	Y=M*	Y=L*	Y=M*
	4**	NC	NC	NC	NC	NC	NC	NC	NC	NC
	10	18	25	9	9,5	6	6	6	3	6
	16	24	31	9	15,5	6	6	10	4	8
	22	30	37	9	21,5	6	10	13	5	10
	26	34	41	9	25,5	6	11	15	6	12
	32	40	47	9	31,5	6	13	18	7	14
	38	46	53	9	37,5	6	15	21	8	16
	51	42	49	11	33,5	8	14	21	7	15
	90	68	75	11	59,5	8	25	36	13	24
	120	68	75	13	59,5	10	24	37	13	24

*L for connectors with LF contacts only - M for connectors with mixed layout or with special contacts

** Shell size dimensions upon request: contact us



CABLE ASSEMBLY TOOLS



LF CONTACTS

CONTACTS TYPES	33
CONTACTS AVAILABILITY	34
HAND CRIMP TOOLS AND SET UP	34
CRIMP INSTRUCTIONS	35
INSERTION/EXTRACTION HAND TOOLS	35

HP CONTACTS

CONTACTS TYPES	36
CONTACTS AVAILABILITY	36
HAND CRIMP TOOLS AND SET UP	37
CRIMP INSTRUCTIONS	38
EXTRACTION HAND TOOLS	38

HF CONTACTS

CONTACTS TYPES	39
CONTACTS AVAILABILITY	39
HAND CRIMP TOOLS AND SET UP	40
CABLE RECOMMENDATIONS	41
CABLE INSTRUCTIONS	43
CRIMP INSTRUCTIONS	43
INSERTION/EXTRACTION HAND TOOLS	43

LF CONTACTS

CONTACTS TYPES

	Crimp on cable	Straight PCB Type Y	Right Angle PCB Type V	Straight SMT Type T	Right Angle SMT Type R
Male					
Female					

CRIMP CONTACTS

	Gauge wire	Reference	Type	2D
Male	AWG 22	12960	C CP CL	
	AWG 24 - 28	12969	S SP SL	
Female	AWG 22	C13064-P	C CP CL	
	AWG 24 - 28	C12468	S SP SL	



LF CONTACTS

CONTACTS AVAILABILITY

		Typical use							
		CRIMP				PCB		SMT	
				Straight		90°		Straight	90°
1 ROW	Male	C - CP - CL AWG 22	S - SP - SL AWG 24 - 28	Y	YL	V	VL	T	R
	Female	C - CP - CL AWG 22	S - SP - SL AWG 24 - 28	Y	YL	V	VL	T	R
2 ROWS	Male	C - CP - CL AWG 22	S - SP - SL AWG 24 - 28	Y	YL	V	VL	T	R
	Female	C - CP - CL AWG 22	S - SP - SL AWG 24 - 28	Y	YL	V	VL	T	R
3 ROWS	Male	C - CP - CL AWG 22	S - SP - SL AWG 24 - 28	Y	YL	V	VL		R
	Female	C - CP - CL AWG 22	S - SP - SL AWG 24 - 28	Y	YL	V			
4 ROWS	Male	C - CP - CL AWG 22	S - SP - SL AWG 24 - 28	Y	YL				
	Female	C - CP - CL AWG 22	S - SP - SL AWG 24 - 28	Y	YL				

Available in All DMM Available in My DMM and Exclusive DMM Y/V: for PCB 1.6mm YL/VL: for PCB 3.2mm T: L= 2.25mm

HAND CRIMP TOOLS AND SET UP

SELECT YOUR CRIMP TOOLS FOR (LF) CONTACTS

Tools	Part Number
Crimp Tool - DANIELS MH800	MH800
Positioner K1692	C12929
Kit Tool - DANIELS MH800 + Positioner K1692	C14925



SET UP YOUR CRIMP TOOLS FOR (LF) CONTACTS*

	Wire AWG Contact Type	Contact part number	Crimp Tool setting	Diameter X	2D
Male	22 - C - CP - CL	12960	6	0,9	
	24 - S - SP - SL	12969	7	0,7	
	26 / 28 - S - SP - SL		6	0,7	
Female	22 - C - CP - CL	C13064-P	6	0,9	
	24 - S - SP - SL	C12468	7	0,7	
	26 / 28 - S - SP - SL		6	0,7	

* according to wire AWG and contacts

LF CONTACTS

→ CRIMP INSTRUCTIONS ICLF01

Set the hand crimp tool according to crimp barrel accommodation table above

Select the crimp tool setting with the selector knob

Put the positioner K1692 in the positioner guide

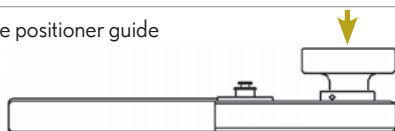

Crimp Tool setting

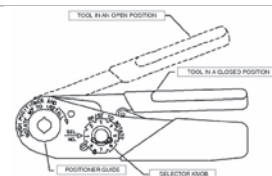

Check the wire stripping

Insert the wire in the contact

The conductor must be visible through the inspection window of the contact



Insert the contact and wire assembly in the crimp guide of the hand crimp tool

In the crimp guide, the contact and wire assembly must be in the end stop position

During the crimping, keep the wire in position

Just one crimping operation is allowed per contact and wire assembly

Visually check the crimping

The crimping must not deform the inspection window

The contact must not have visible fractures or cracks

The contact barrel must not be deformed or bent

Check the contact is firmly crimped, by pulling gently

For that purpose, two fingers are enough: pinch the wire and pull smoothly along the axis of the crimped contact

	AWG	Newton	
		Silver/tin plated wire	Nickel plated wire
LF contacts	28	13.4	8.9
	26	22.3	13.4
	24	35.6	26.7
	22	53.4	35.6

Nicomatic results > to IPC/WHMA-A-620A as shown above

→ INSERTION / EXTRACTION HAND TOOLS

HOW TO ORDER YOUR INSERTION / EXTRACTION TOOLS? PART NUMBER

Check the wire stripping

Kit Insertion/Extraction Tool - Body, plug, insertion tips, extraction tips

C12935



Spare parts

Body	13241
Plug	13240
Extraction Tip for female contact	13170
Extraction Tip for male contact	13242
Insertion Tip for AWG 24-28 (S)	13171
Insertion Tip for AWG 22 (C)	13172

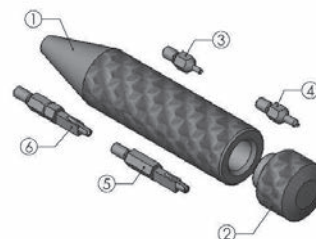



HP CONTACTS

CONTACTS TYPES

	Straight Crimp	Straight Solder	Straight PCB	90° PCB
Male				
Female				

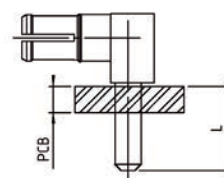
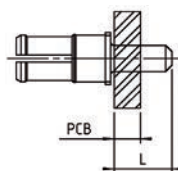

CONTACTS AVAILABILITY

		Typical use			
		CABLE	PCB		
		Straight Crimp or Solder	Straight	90°	
1ROW	Male	-	-	-	-
	Female	-	-	-	-
2 ROWS	Male	30-33XX	30-3300DMM	30-3300-45	30-3400DMM
	Female	30-33XX	30-4300DMM	30-4300-45	30-4400DMM
3 ROWS	Male	30-33XX	30-3300DMM	30-3300-45	30-3400DMM
	Female	30-33XX	30-4300DMM	30-4300-45	30-4400DMM
4 ROWS	Male	30-33XX	30-3300DMM	30-3300-45	-
	Female	30-33XX	30-4300DMM	30-4300-45	-

Available in All DMM XX = Amp Eg. 08 for 8Amp (10-15-20)

HP CONTACTS

→ HAND CRIMP TOOLS AND SET UP

SELECT YOUR CRIMP TOOLS FOR HIGH POWER (HP) CONTACTS

Tools	Part Number
Crimp Tool - AF8	16459
Positioner	C16460
Kit Tool - AF8 + Positioner C16460	C16462



SET UP YOUR CRIMP TOOLS FOR HIGH POWER (HP) CONTACTS*

		Crimp tool setting								
	Loaded contact part number	Unloaded contact part number	Amp	AWG	Number of visual marks	AWG20	AWG18	AWG16	AWG14	AWG12
Male	3305	30-3305	5	20	3	3				
	3308	30-3308	8	18	2		4			
	3310	30-3310	10	16-18-20	1	4	4	5		
	3315	30-3315	15	14	0				6	
	3320	30-3320	20	12	0					8
Female	4305	30-4305	5	20	3	3				
	4308	30-4308	8	18	2		4			
	4310	30-4310	10	16-18-20	1	4	4	5		
	4315	30-4315	15	14	0				6	
	4320	30-3320	20	12	0					8

* according to wire AWG, contacts and visuels marks

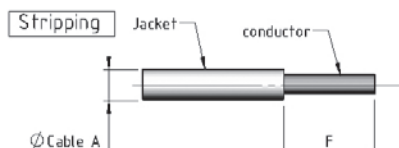
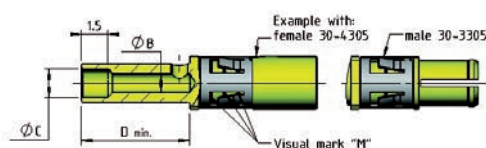

DIMENSIONS AND CONDUCTOR LENGTH

	Loaded contact part number	Unloaded contact part number	Amp	Length F conductor	B Ø	Cable A Ø
Male	3305	30-3305	5	4.5mm	1.1mm	<1.6mm
	3308	30-3308	8	4.5mm	1.35mm	<1.8mm
	3310	30-3310	10	6mm	1.7mm	-
	3315	30-3315	15	6mm	2mm	-
	3320	30-3320	20	5.3mm	2.6mm	-
Female	4305	30-4305	5	4.5mm	1.1mm	<1.6mm
	4308	30-4308	8	4.5mm	1.35mm	<1.8mm
	4310	30-4310	10	6mm	1.7mm	-
	4315	30-4315	15	6mm	2mm	-
	4320	30-3320	20	5.3mm	2.6mm	-

- Jacket not inserted in the pin



HP CONTACTS

→ CRIMP INSTRUCTIONS IC30HP02

Insert the cable into the contact

The conductor must be visible through the window of the contact

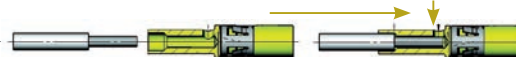

Set the hand crimp tool according to crimp barrel accommodation table above

Select the selector number with the selector knob (see crimp tool setting)

Put the positioner C16460 on the hand crimp tool 16459

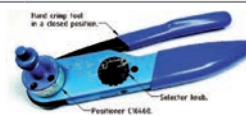

Insert the contact and wire assembly in the crimp guide of the hand crimp

In the crimp guide, the contact and wire assembly must be in the end stop position

During crimping, keep the wire in position

Just one crimping operation is allowed per contact and wire assembly

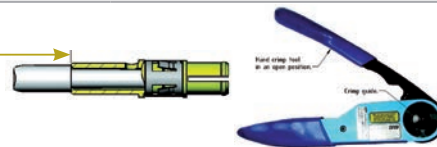

Visually check crimping

Crimping must not deform the inspection window

Contact must not have visible fractures or cracks

Contact barrel must not be deformed or bent

Crimping must not deform the end of the contact



Check it is firmly crimped by pulling gently

For that purpose two fingers are enough: pinch the wire and pull smoothly along the axis of the crimped contact

	AWG	Newton	
		Silver/tin plated wire	Nickel plated wire
HP contacts	20	89	84.6
	18	142	NE
	16	222.3	164.6
	14	311.5	266.9
	12	489.5	455

Nicomatic results > to IPC/WHMA-A-620A as shown above

→ EXTRACTION HAND TOOLS

HOW TO ORDER YOUR EXTRACTION TOOLS FOR HIGH POWER?

Tool	Part number	
Extraction tool	12368	

Also applicable for HF contacts



HF CONTACTS

→ HAND CRIMP TOOLS AND SET UP

SELECT YOUR CRIMP TOOLS FOR HIGH FREQUENCY (HF) CONTACTS

FOR INNER CONTACT

Tools	Part Number
Crimp Tool - MH800	MH800
Positioner - K1131	K1131
Kit Tool - MH800 + Positioner K1131	C12237



FOR SLEEVE CONTACT

Crimp Tool - HX3	13858
------------------	-------



SELECT YOUR CRIMP INSTRUCTIONS

Three crimp instructions guides are proposed according to contact types and dies. Please refer to table below to choose the crimp instruction you need.

		Instruction		
Dies for contacts below	Dies Part number	IC30HF01 page 39	IC30HF02 page 40	IC30HF03 page 41
Male	30-1312-ZS-01			
	30-1312-ZS-02			
	30-1320-SS	C13847		
	30-1324-SS			
	30-1326-SS			
	30-1320-DS			
	30-1326-DS	C14680		
	30-1420-DS	C13847		
	30-1426-DS	C14680		
	30-1412-ZS			
	30-1420-ZS	C13847		
	30-1424-ZS			
30-1426-ZS				
Male	30-2312-ZS-01			
	30-2312-ZS-02			
	30-2320-SS	C13847		
	30-2324-SS			
	30-2326-SS			
	30-2320-DS			
	30-2326-DS	C14680		
	30-2420-DS	C13847		
	30-2426-DS	C14680		
	30-2412-ZS			
	30-2420-ZS	C13847		
	30-2424-ZS			
30-2426-ZS				

HF CONTACTS

→ CABLE RECOMMENDATIONS

	NORM		Ø Cable	HF CONTACTS			CONNECTION MODE		
	MIL-C-17	NF C93-550		Series	Gender	Contact P / N	Central contact	Shield	Impedance
HF CONTACTS	RG 178	KX 21A	2mm	HF30	Male	30-1320-SS	Crimped	Crimped Hex. 2.4mm	50 Ohm
						30-1420-ZS	Solder		
					Female	30-2320-SS	Crimped		
						30-2420-ZS	Solder		
	RG 316	KX 22 A	2.7mm	HF30	Male	30-1326-SS	Crimped	Crimped Hex. 2.8mm	50 Ohm
						30-1426-ZS	Solder		
					Female	30-2326-SS	Crimped		
						30-2426-ZS	Solder		
	RG 174	KX 3 B	2.7mm	HF30	Male	30-1326-SS	Crimped	Crimped Hex. 2.8mm	50 Ohm
						30-1426-ZS	Solder		
					Female	30-2326-SS	Crimped		
						30-2426-ZS	Solder		
RG 179		2.7mm	HF30	Male	30-1326-SS-75	Crimped	Crimped Hex. 2.8mm	75 Ohm	
					30-1426-ZS-75	Solder			
				Female	30-2326-SS-75	Crimped			
					30-2426-ZS-75	Solder			

	Supplier	P / N	Ø Cable	HF CONTACTS			CONNECTION MODE		
				Series	Gender	Contact P / N	Central contact	Shield	Impedance
SEMI-RIGID		UT47	1.2mm	HF30	Male	30-1347-ZZ	Solder	Solder	50 Ohm
						30-1447-ZZ			
					Female	30-2347-ZZ			
						30-2447-ZZ			
	(Axon*)	UT85 (QFX 86 SPCW*)	2.2mm	HF30	Male	30-1385-ZZ	Solder	Solder	50 Ohm
						30-1485-ZZ			
					Female	30-2385-ZZ			
						30-2485-ZZ			

Specific sleeve upon request



HF CONTACTS

CABLE RECOMMENDATIONS

Supplier	P / N	Ø Cable	HF CONTACTS			CONNECTION MODE														
			Series	Gender	Contact P / N	Central contact	Shield	Impedance												
SPECIAL	Nexans (Axon*)	50VMTX (SM 50 *)	1.2mm	HF30	Male	30-1312-ZS-01 (30-1312-ZS-02 *)	Solder	Crimped Hex. 19mm	50 Ohm											
					Female	30-1412-ZS 30-2312-ZS-01 (30-2312-ZS-02 *)														
						30-2412-ZS														
					75VMTX (SM 75 *)	1.2mm				HF30	Male	30-1312-ZS-75-01 (30-1312-ZS-75-02 *)	Solder	Crimped Hex. 19mm	75 Ohm					
											Female	30-1412-ZS-75 30-2312-ZS-75-01 (30-2312-ZS-75-02 *)								
												30-2412-ZS-75								
	Axon RG 178 DT	P500955	2.3mm	HF30			Male	30-1320-DS 30-1420-DS	Crimp or solder Solder		Crimped Hex. 2,8mm	50 Ohm								
					Female	30-2320-DS 30-2420-DS	Crimp or solder Solder													
						Axon PTFE Cellular	P 812817	2.3mm	HF30	Male			30-1324-DS 30-1424-DS	Crimp or solder Solder	Crimped Hex. 2.8mm	50 Ohm				
					Female					30-2324-DS 30-2424-DS			Crimp or solder Solder							
										P 804298 B			2.4mm	HF30			Male	30-1324-DS-75 30-1424-DS-75	Crimp or solder Solder	Crimped Hex. 2.8mm
					Female												30-2324-DS-75 30-2424-DS-75	Crimp or solder Solder		
Axon RG 316 DT	P0530912	2.7mm	HF30	Male		30-1326-DS 30-1426-DS	Crimp or solder Solder	Crimped Hex. 3.25mm	50 Ohm											
				Female	30-2326-DS 30-2426-DS	Crimp or solder Solder														
					Axon RG 179 DT	P530268	3.0mm			HF30	Male	30-1326-DS-75 30-1426-DS-75	Crimp or solder Solder	Crimped Hex. 3.25mm	75 Ohm					
				Female							30-2326-DS-75 30-2426-DS-75	Crimp or solder Solder								

DT = DS = double shield

	ØB	ØC	Sleeve
P/N terminal -01 for 50VMTX cable type	1mm	1.25mm	
P/N terminal -02 for SM 50 cable type	0.85mm	1.15mm	

HF CONTACTS

→ CRIMP INSTRUCTIONS IC30HF01

Example with male HF coax contact

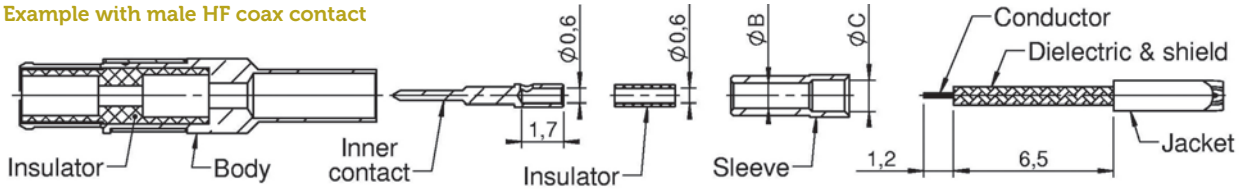

Thread the sleeve until stop on to the cable

Place the shield on the sleeve

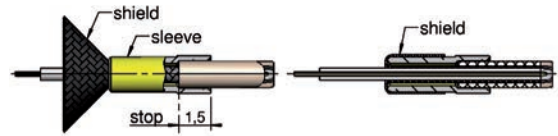

Thread the insulator

Solder the inner contact on the conductor

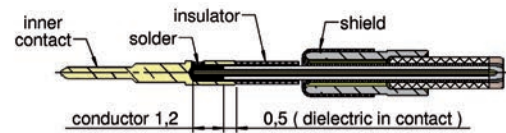

Thread to the body

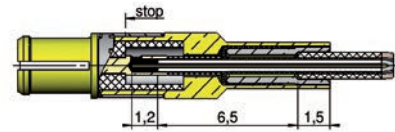

Crimp

Tool: DANIELS HX3

Die: C13847

Hexagone: 1.9mm / flat



	ØB	ØC	Sleeve
P/N Terminal -01	1	1,25	ØB ØC
P/N Terminal -02	0,85	1,15	



Position: 9.95mm

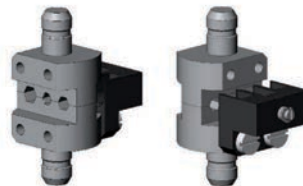
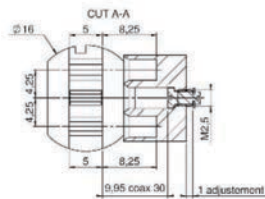

→ EXTRACTION HAND TOOLS

HOW TO ORDER YOUR EXTRACTION TOOLS FOR HIGH FREQUENCY?

Tool

Part number

Extraction tool

12368



Also applicable for HP contacts

HF CONTACTS

→ CRIMP INSTRUCTIONS IC30HF02

Example with male HF coax contact

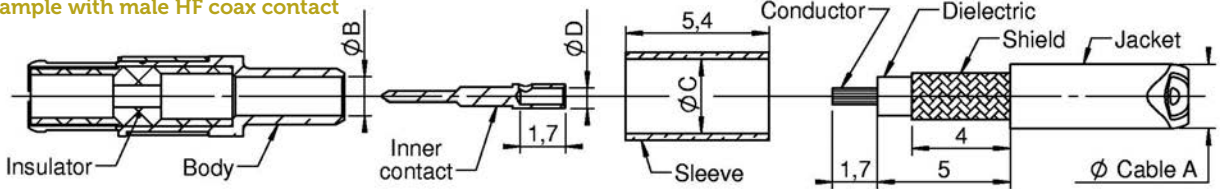

Mount the inner contact on the conductor

Solder or crimp with DANIELS MH800 positionner K1131

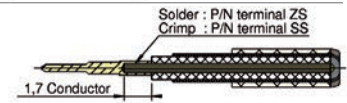

Thread the sleeve onto the cable and bent the shield at 90°

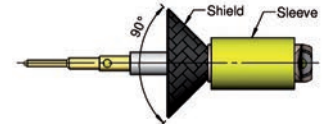

Push until stop inside the body

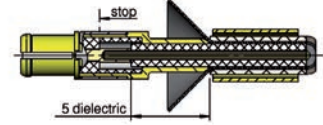

Thread the sleeve until stop on the body so as to bent the shield

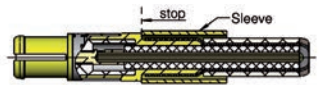

Crimp the sleeve



	Cable Ø A	Body Ø B	Sleeve Ø C	Contact Ø D	Central crimp DANIELS MH800		Hexagonal imprint E sleeve crimp DANIELS HX3 tool				
					Positioner K1131		Die C13847		Die C14680		
					Conductor Ø 0.3	Conductor Ø 0.5	Hex. 1.9	Hex. 2.4	Hex. 2.8	Hex. 3.25	Hex. 4
30-x320-SS	2mm	1mm	2.2mm	0.5mm	Position 2/3	Position 3/4					
30-x320-DS	2.3mm	1mm	2.8mm	0.5mm							
30-x324-SS	2.4mm	1.5mm	2.8mm	0.6mm							
30-x326-SS	2.7mm	1.7mm	2.8mm	0.6mm							
30-x326-DS	3mm	1.7mm	3.25mm	0.6mm							

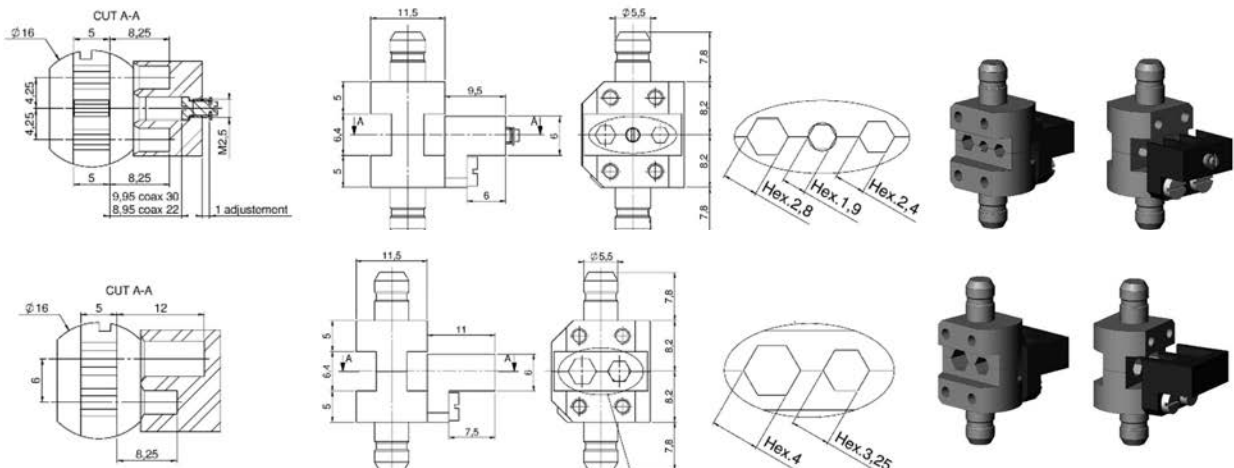

HF CONTACTS

→ CRIMP INSTRUCTIONS IC30HF03

Example with male HF coax contact

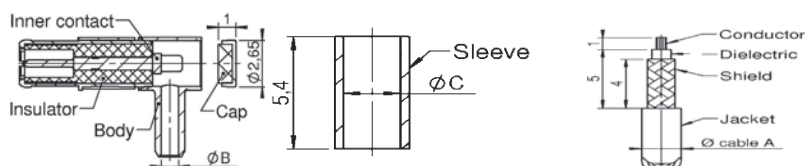

Thread the sleeve on cable and bent the shield at 90°

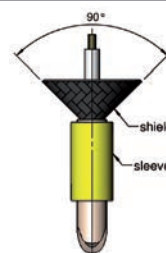

Place the inner contact until stop on the body.

Insert the cable and solder the conductor onto the inner contact

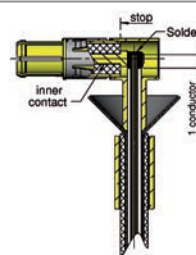

Thread the sleeve until stop on the body so as to bent the shield

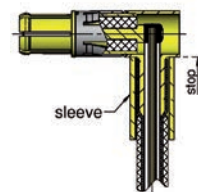

Crimp the sleeve with DANIELS HX3 tool and mount the back cap with tool P/N C14772

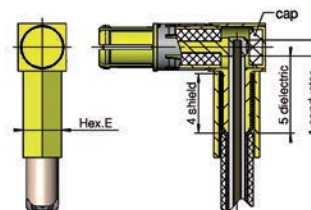
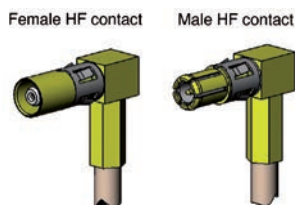

					Hexagonal imprint E sleeve crimp DANIELS HX3 tool				
	Cable Ø A	Body Ø B	Sleeve Ø C	Contact	Die C13847			Die C14680	
					Hex. 19	Hex. 2.4	Hex. 2.8	Hex. 3.25	Hex. 4
30-x412-ZS	1.2 mm	0.7mm	1.3mm	solder					
30-x420-ZS	2mm	1mm	2.2mm	solder					
30-x420-DS	2.3mm	1mm	2.8mm	solder					
30-x424-ZS	2.4mm	1.5mm	2.8mm	solder					
30-x426-ZS	2.7mm	1.7mm	2.8mm	solder					
30-x426-DS	3mm	1.7mm	3.25mm	solder					



DMM PANEL MOUNT INFORMATION

FRONT PANEL

Male

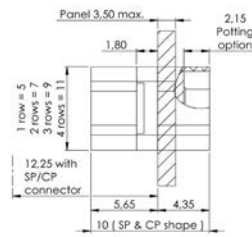

Female

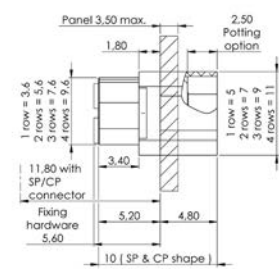

REAR PANEL

Cable male

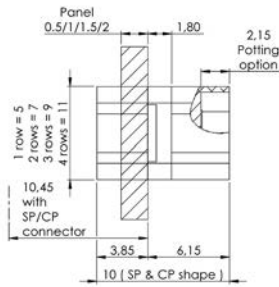

Straight male

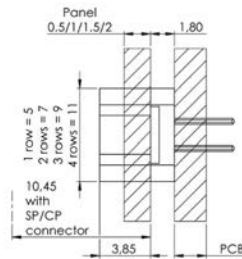

90° male

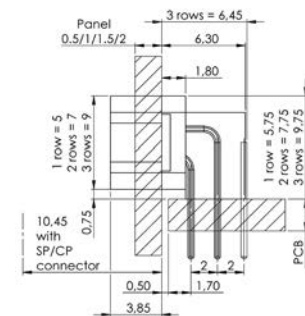

Cable female

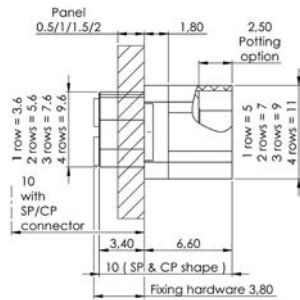

Straight female

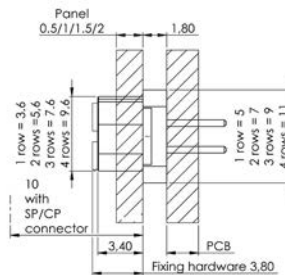

90° female

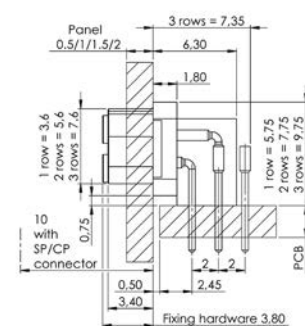

DMM SPECIFIC DEVELOPMENTS

CUSTOM CONNECTORS: MAKE IT EASY FROM DESIGN TO MANUFACTURING

EXAMPLES OF DMM SPECIFIC DEVELOPMENTS

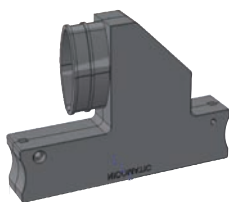

90° parallel

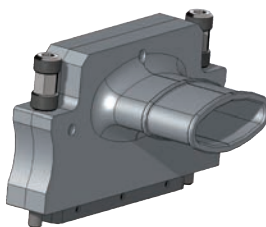

90° Side entry



Built-in Backshell



Backshell
for Helicopter application



Backshell
for Helicopter application



Backshell
for multi racking application

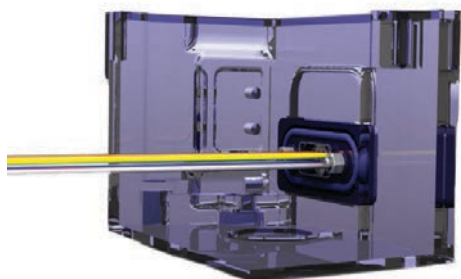

Q-ring DMM

Date of issue : june 2013
Catalogue reference : C.DMM.2000/GB

NICOMATIC maintains a policy of ongoing development and improvement. It therefore reserves the right to change design, dimensions and specifications without notice. All information stated inside this catalogue is not contractual and subject to change (eg. standard connector configurations).