

DC/DC converter

Input 9-36 and 18-72 Vdc
Output up to 0.5A/3W

Key Features

- Industry standard DIL24
- Wide input voltage range, 9–36V, 18–72V
- High efficiency 74–83% typical
- Low idling power
- Full output power up to +75°C ambient temperature
- Input/Output isolation 1,500 Vdc
- MTBF > 650,000 hours at +25°C ambient
- Basic insulation according to UL 60950-1



Safety Approvals



Design for Environment



Meets requirements in high-temperature lead-free soldering processes.

The PKV series of DC/DC power modules is intended for general use in 12/24V and 48/60V DC systems. Designed with MOSFET transistors and 200 kHz switching frequency, they are characterized by high efficiency over a wide load range, very low quiescent power and an excellent line and load regulation.

The DC/DC power modules are encapsulated in an epoxy filled plastic box. The flammability ratings of the en-

capsulating materials are in conformance with UL 94V-0 and have an adequate thermal conductivity. The materials withstand all normal PBA cleaning methods. Ericsson Power Modules is an ISO 9001/14001 certified supplier.

General

Absolute Maximum Ratings

Characteristics		min	max	Units
T _C	Case temperature ¹⁾	-40	+95	°C
T _S	Storage temperature	-40	+125	°C
V _I	Input voltage, 0.1 s max PKV 3000 PKV 5000		40 80	V _{dc}
V _{ISO}	Isolation voltage (input to output test voltage)	1,500		V _{dc}

Stress in excess of Absolute Maximum Ratings may cause permanent damage. Absolute Maximum Ratings, sometimes referred to as no destruction limits, are normally tested with one parameter at a time exceeding the limits of Output data or Electrical Characteristics. If exposed to stress above these limits, function and performance may degrade in an unspecified manner.

Note:

¹⁾ Corresponding typical ambient temperature range (T_A) at full output power is -40 to +75°C.

Input T_A = +25°C, unless otherwise specified

Characteristics		Conditions	min	typ	max	Units
V _I	Input voltage range	T _A = -40 to +75°C PKV 3000 PKV 5000	9 18		36 72	V
V _{Ioff}	Turn-off input voltage	PKV 3000 PKV 5000			8 16	V
	Inrush current Peak I _{2t}	Low loss, low inductive capacitive source PKV 3000 PKV 5000		35 0.005 0.005		A A ² s A ² s
	Idling power	I _O = 0		0.3		W
V _{Iac}	Ripple voltage	I _O = I _{Omax} , BW=20 MHz		100		mV _{p-p}

Miscellaneous

Characteristics		Conditions	min	typ	max	Unit
	Input/Output coupling capacitor	RH = 48%, T _C = +25°C f = 100 Hz		1000		pF
	Switching frequency	V _I = V _{I nom} , I _O = I _{O max}		200		kHz

Environmental Characteristics

Test method	Reference	Test procedure & conditons	
Vibration (Sinusoidal)	IEC 68-2-6 F _C	Frequency Amplitude Acceleration Number of cycles Test duration	10...500Hz 0.75 mm 10 g 10 in each axis 1 h per axis
Shock (Half-sinus)	IEC 68-2-27 E _a	Peak acceleration Shock duration	200g 3 ms
Temperature change	IEC 68-2-14 N _a	Temperature Number of cycles	-40°C to +125°C 100

Safety

The PKV 3000 I and PKV 5000 I series DC/DC converters are designed in accordance with safety standards UL 60 950-1, *Safety of Information Technology Equipment*. The PKV 3000 I and PKV 5000 I series DC/DC converters are UL 60 950-1 recognized. The DC/DC converter should be installed in the end-use equipment, in accordance with the requirements of the ultimate application. The input source must be isolated by minimum Basic insulation from the primary circuit in accordance with UL 60 950-1. If the input voltage to the DC/DC converter is 72 V dc or less, then the output remains SELV (Safety Extra Low Voltage) under normal and abnormal operating conditions.

It is recommended that a slow blow fuse with a rating of 2 x I_{I max} be used at the input of each DC/DC converter. If a fault occurs in the converter that imposes a short circuit on the input source, this fuse will provide the following functions:

- Isolate the faulty DC/DC converter from the input power source not to affect the operation of other parts of the system.
- Protect the distribution wiring from excessive current and power loss thus preventing hazardous overheating.

The galvanic isolation is verified in an electric strength test. The test voltage (V_{ISO}) between input and output is 1500 V_{dc} for 60 seconds. Leakage current is less than 1µA at nominal input voltage.

The flammability rating for all construction parts of the DC/DC converter meets UL 94V-0.

Mechanical Data

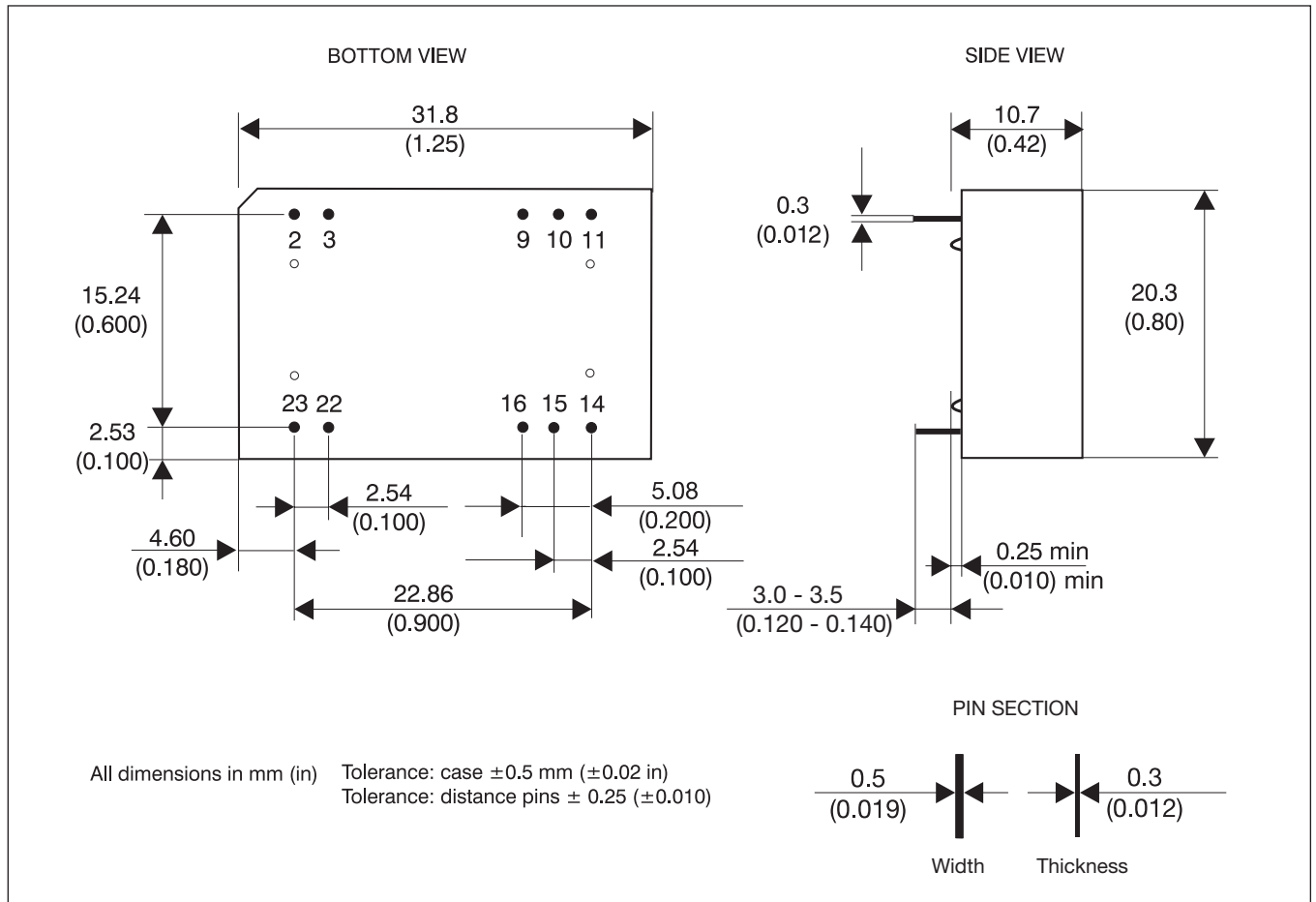

Connections

Pin	Designation	Function	
		Single output	Dual output
2	-In	Negative input	Negative input
3	-In	Negative input	Negative input
9	NC/Rtn	Not connected	Output return
10	NC	Not connected	Not connected
11	NC/-Out	Not connected	Negative output
14	+Out	Positive output	Positive output
15	NC	Not connected	Not connected
16	Rtn	Output return	Output return
22	+In	Positive input	Positive input
23	+In	Positive input	Positive input

Weight:

Maximum 15 g
(0.53 oz).

Pins:

Material: Copper
Plating: 3 μ m Tin over 1.5 μ m Ni

Case:

Non conductive
plastic, UL 94V-0.

PKV 3110 PI

Output

$T_A = +25^\circ\text{C}$, $V_I = 9\text{...}36\text{ V}$ unless otherwise specified.

Characteristics		Conditions		Output 1			Unit
				min	typ	max	
V_O	Output voltage tolerance band	$I_O = 0.1 \dots 1.0 \times I_{O\text{max}}$ and long term drift		3.20		3.40	V
	Line regulation	$I_O = I_{O\text{max}}$			6.6	16.5	mV
	Load regulation	$I_O = 0.1 \dots 1.0 \times I_{O\text{max}}$, $V_I = 26\text{ V}$			6.6	33	mV
t_{tr}	Load transient recovery time	$I_O = 0.1 \dots 1.0 \times I_{O\text{max}}$, $V_I = 26\text{ V}$ load step = $0.5 \times I_{O\text{max}}$			300		μs
V_{tr}	Load transient voltage				+100		mV
						-100	
T_{coeff}	Temperature coefficient	Measured after stabilization				± 0.02	$\%/^\circ\text{C}$
t_r	Ramp-up time	$I_O = 0.1 \dots 1.0 \times I_{O\text{max}}$, $V_I = 26\text{ V}$	$0.1 \dots 0.9 \times V_O$		0.5		ms
t_s	Start-up time		From V_I connection to $V_O = 0.9 \times V_{O\text{i}}$		800	1300	
I_O	Output current					0.5	A
$P_{O\text{max}}$	Max output power			1.65			W
I_{lim}	Current limiting threshold ¹⁾	$T_C < T_{C\text{max}}$		0.50		1.62	A
I_{sc}	Short circuit current	$V_I = 26\text{ V}$			0.20		A
$V_{O\text{ac}}$	Output ripple & noise	$I_O = I_{O\text{max}}$, $T_A = 25^\circ\text{C}$	DC... 20 MHz		60		mV _{p-p}
SVR	Supply voltage rejection (ac)	$f = 100/120\text{ Hz}$ sine wave, 1 V_{p-p} , ($\text{SVR} = 20 \log(1\text{ V}_{p-p}/V_{O\text{p-p}})$)			60		dB

¹⁾ At $V_{\text{out}} \leq 80\%$ of nominal the power module goes into hiccup mode.

Miscellaneous

Efficiency (typ)

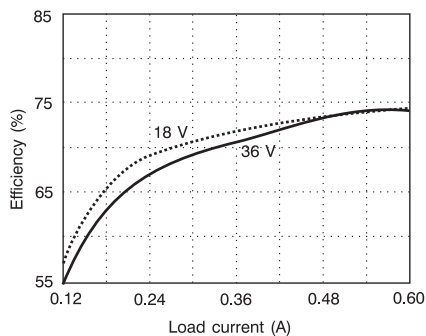

Power derating

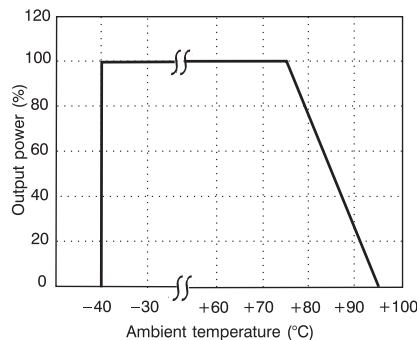

Characteristics		Conditions	min	typ	max	Unit
η	Efficiency	$I_O = I_{O\text{max}}$, $V_I = 26\text{ V}$	66	73		%
P_d	Power dissipation	$I_O = I_{O\text{max}}$, $V_I = 26\text{ V}$		0.61	0.85	W

PKV 3211 PI

Output

$T_A = +25^\circ\text{C}$, $V_I = 9\text{...}36\text{ V}$ unless otherwise specified.

Characteristics		Conditions	Output 1			Unit
			min	typ	max	
V_O	Output voltage tolerance band	$I_O = 0.1 \dots 1.0 \times I_{O\text{max}}$ and long term drift	4.90		5.10	V
	Line regulation	$I_O = I_{O\text{max}}$		10	25	mV
	Load regulation	$I_O = 0.1 \dots 1.0 \times I_{O\text{max}}$, $V_I = 26\text{ V}$		10	50	mV
t_{tr}	Load transient recovery time	$I_O = 0.1 \dots 1.0 \times I_{O\text{max}}$, $V_I = 26\text{ V}$ load step = $0.5 \times I_{O\text{max}}$		300		μs
V_{tr}	Load transient voltage		+100			mV
			-100			mV
T_{coeff}	Temperature coefficient	Measured after stabilization			± 0.02	%/ $^\circ\text{C}$
t_r	Ramp-up time	$I_O = 0.1 \dots 1.0 \times I_{O\text{max}}$, $V_I = 26\text{ V}$	$0.1 \dots 0.9 \times V_O$		0.5	ms
t_s	Start-up time		From V_I connection to $V_O = 0.9 \times V_{O1}$		800	1300
I_O	Output current				0.5	A
$P_{O\text{max}}$	Max output power		2.5			W
I_{lim}	Current limiting threshold ¹⁾	$T_C < T_{C\text{max}}$	0.5		1.62	A
I_{sc}	Short circuit current	$V_I = 26\text{ V}$		0.25		A
$V_{O\text{ac}}$	Output ripple & noise	$I_O = I_{O\text{max}}$, $T_A = 25^\circ\text{C}$	DC20 MHz	60		mV _{p-p}
SVR	Supply voltage rejection (ac)	$f = 100/120\text{ Hz}$ sine wave, 1 V_{p-p} , ($\text{SVR} = 20 \log(1\text{ V}_{p-p}/V_{O\text{p-p}})$)		60		dB

¹⁾ At $V_{\text{out}} \leq 80\%$ of nominal the power module goes into hick up mode.

Miscellaneous

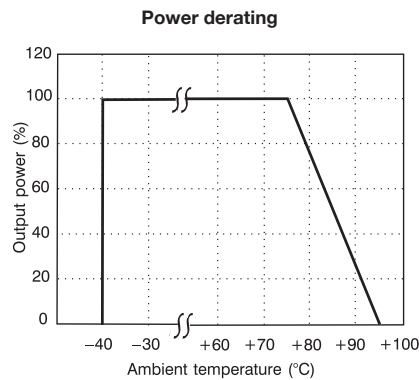
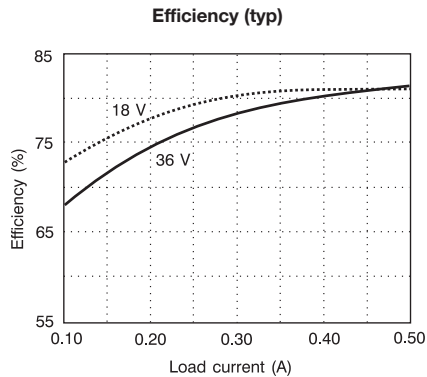

Characteristics		Conditions	min	typ	max	Unit
η	Efficiency	$I_O = I_{O\text{max}}$, $V_I = 26\text{ V}$	76	82		%
P_d	Power dissipation	$I_O = I_{O\text{max}}$, $V_I = 26\text{ V}$		0.55	0.79	W

PKV 3313 PI

Output

$T_A = +25^\circ\text{C}$, $V_I = 9\text{...}36\text{ V}$ unless otherwise specified.

Characteristics		Conditions	Output 1			Unit
			min	typ	max	
V_O	Output voltage tolerance band	$I_O=0.1\text{...}1.0 \times I_{O\text{max}}$ and long term drift	11.76		12.24	V
	Line regulation	$I_O=I_{O\text{max}}$		24	60	mV
	Load regulation	$I_O=0.1\text{...}1.0 \times I_{O\text{max}}$, $V_I = 26\text{ V}$		24	120	mV
t_{tr}	Load transient recovery time	$I_O=0.1\text{...}1.0 \times I_{O\text{max}}$, $V_I = 26\text{ V}$ load step = $0.5 \times I_{O\text{max}}$		300		μs
V_{tr}	Load transient voltage		+150			mV
			-150			mV
T_{coeff}	Temperature coefficient	Measured after stabilization			± 0.02	$\%/^\circ\text{C}$
t_r	Ramp-up time	$I_O=0.1\text{...}1.0 \times I_{O\text{max}}$, $V_I = 26\text{ V}$	$0.1\text{...}0.9 \times V_O$		1.2	ms
t_s	Start-up time		From V_I connection to $V_O=0.9 \times V_{O1}$		800	1300
I_O	Output current				0.25	A
$P_{O\text{max}}$	Max output power		3			W
I_{lim}	Current limiting threshold ¹⁾	$T_C < T_{C\text{max}}$	0.25		0.81	A
I_{sc}	Short circuit current	$V_I=26\text{ V}$		0.35		A
$V_{O\text{ac}}$	Output ripple & noise	$I_O=I_{O\text{max}}$, $T_A = 25^\circ\text{C}$	DC... 20 MHz		60	mV _{p-p}
SVR	Supply voltage rejection (ac)	$f = 100/120\text{ Hz}$ sine wave, 1 V_{p-p} , ($\text{SVR} = 20 \log(1\text{ V}_{p-p}/V_{O\text{p-p}})$)		60		dB

¹⁾ At $V_{\text{out}} \leq 80\%$ of nominal the power module goes into hick up mode.

Miscellaneous

Efficiency (typ)

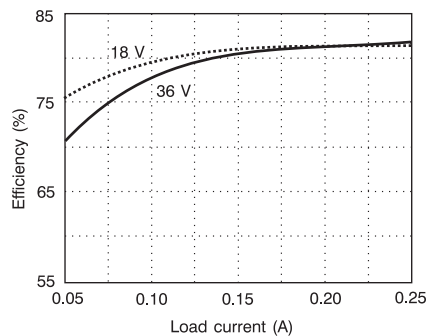

Power derating

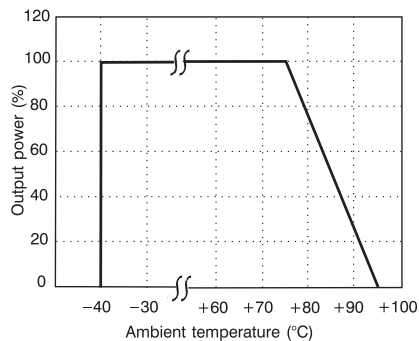

Characteristics		Conditions	min	typ	max	Unit
η	Efficiency	$I_O=I_{O\text{max}}$, $V_I = 26\text{ V}$	76	82		%
P_d	Power dissipation	$I_O=I_{O\text{max}}$, $V_I = 26\text{ V}$		0.66	0.95	W

PKV 3315 PI

Output

$T_A = +25^\circ\text{C}$, $V_I = 9...36\text{ V}$ unless otherwise specified.

Characteristics		Conditions		Output 1			Unit	
				min	typ	max		
V_O	Output voltage tolerance band	$I_O = 0.1 \dots 1.0 \times I_{Omax}$ and long term drift		14.7		15.3	V	
	Line regulation	$I_O = I_{Omax}$			30	75	mV	
	Load regulation	$I_O = 0.1 \dots 1.0 \times I_{Omax}$, $V_I = 26\text{ V}$			30	150	mV	
t_{tr}	Load transient recovery time	$I_O = 0.1 \dots 1.0 \times I_{Omax}$, $V_I = 26\text{ V}$ load step = $0.5 \times I_{Omax}$			300		μs	
V_{tr}	Load transient voltage				+200			mV
					-200			mV
T_{coeff}	Temperature coefficient	Measured after stabilization				± 0.02	%/ $^\circ\text{C}$	
t_r	Ramp-up time	$I_O = 0.1 \dots 1.0 \times I_{Omax}$, $V_I = 26\text{ V}$	$0.1 \dots 0.9 \times V_O$		1.2		ms	
t_s	Start-up time		From V_I connection to $V_O = 0.9 \times V_{Oi}$		800	1300	ms	
I_O	Output current					0.2	A	
P_{Omax}	Max output power			3			W	
I_{lim}	Current limiting threshold ¹⁾	$T_C < T_{Cmax}$		0.2		0.65	A	
I_{sc}	Short circuit current	$V_I = 26\text{ V}$			0.35		A	
V_{Oac}	Output ripple & noise	$I_O = I_{Omax}$, $T_A = 25^\circ\text{C}$	DC ... 20 MHz		60		mV _{p-p}	
SVR	Supply voltage rejection (ac)	$f = 100/120\text{ Hz}$ sine wave, 1 V_{p-p} , (SVR = $20 \log(1\text{ V}_{p-p}/V_{O-p-p})$)			60		dB	

¹⁾ At $V_{out} \leq 80\%$ of nominal the power module goes into hick up mode.

Miscellaneous

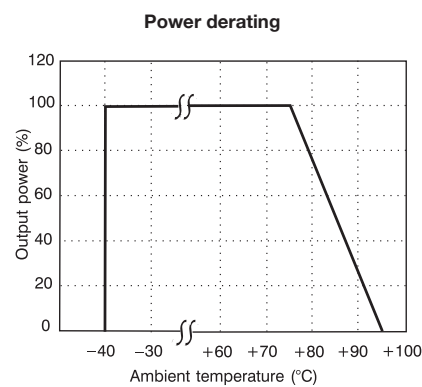
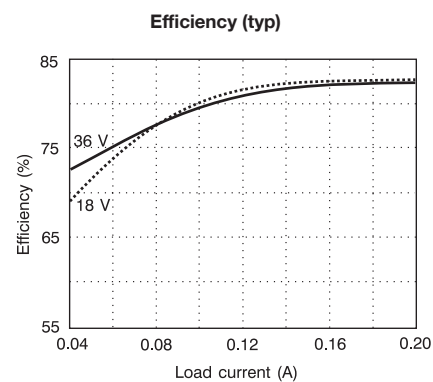

Characteristics		Conditions	min	typ	max	Unit
η	Efficiency	$I_O = I_{Omax}$, $V_I = 26\text{ V}$	76	82		%
P_d	Power dissipation	$I_O = I_{Omax}$, $V_I = 26\text{ V}$		0.66	0.95	W

PKV 3222 PI

Output

$T_A = +25^\circ\text{C}$, $V_I = 9...36\text{V}$ unless otherwise specified.

Characteristics		Conditions		Output 1			Output 2			Unit
				min	typ	max	min	typ	max	
V_O	Output voltage tolerance band	$I_O = 0.1 \dots 1.0 \times I_{Omax}$ and long term drift		+4.9		+5.1	-4.9		-5.1	V
	Line regulation	$I_O = I_{Omax}$		10		25	10		25	mV
	Load regulation	$I_O = 0.1 \dots 1.0 \times I_{Omax}$, $V_I = 26\text{ V}$		10		50	10		50	mV
t_{tr}	Load transient recovery time	$I_O = 0.1 \dots 1.0 \times I_{Omax}$, $V_I = 26\text{ V}$ load step = $0.5 \times I_{Omax}$		300			300			μs
V_{tr}	Load transient voltage			+100			+100			mV
				-100			-100			mV
T_{coeff}	Temperature coefficient	Measured after stabilization		± 0.02			± 0.02			%/ $^\circ\text{C}$
t_r	Ramp-up time	$I_O = 0.1 \dots 1.0 \times I_{Omax}$, $V_I = 26\text{ V}$	$0.1 \dots 0.9 \times V_O$	1.2			1.2			ms
t_s	Start-up time		From V_I connection to $V_O = 0.9 \times V_{O1}$	800	1300	800	1300	ms		
I_O	Output current			0.25			0.25			A
P_{Omax}	Max output power			1.25			1.25			W
I_{lim}	Current limiting threshold ¹⁾	$T_C < T_{Cmax}$		0.25		0.81	0.25		0.81	A
I_{sc}	Short circuit current	$V_I = 26\text{ V}$		0.25			0.25			A
V_{Oac}	Output ripple & noise	$I_O = I_{Omax}$, $T_A = 25^\circ\text{C}$	DC...20 MHz	60			60			mV _{p-p}
SVR	Supply voltage rejection (ac)	$f = 100/120\text{ Hz sine wave}$, 1 V_{p-p} , ($SVR = 20 \log(1\text{ V}_{p-p}/V_{O p-p})$)		45			45			dB

¹⁾ At $V_{out} \leq 80\%$ of nominal the power module goes into hick up mode.

Miscellaneous

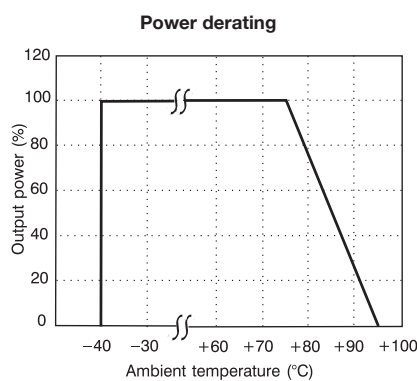
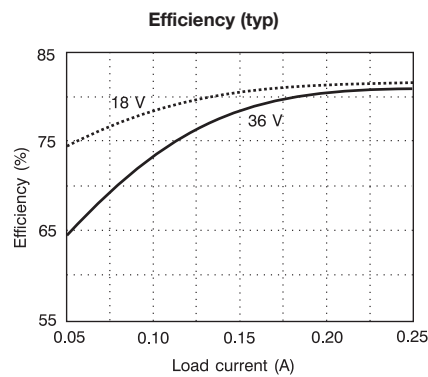

Characteristics		Conditions		min	typ	max	Unit
η	Efficiency	$I_O = I_{Omax}$, $V_I = 26\text{ V}$		75	82		%
P_d	Power dissipation	$I_O = I_{Omax}$, $V_I = 26\text{ V}$			0.55	0.83	W

PKV 3321 PI

Output

$T_A = +25^\circ\text{C}$, $V_I = 9...36\text{V}$ unless otherwise specified.

Characteristics		Conditions		Output 1			Output 2			Unit
				min	typ	max	min	typ	max	
V_O	Output voltage tolerance band	$I_O = 0.1 \dots 1.0 \times I_{Omax}$ and long term drift		+11.76		+12.24	-11.76		-12.24	V
	Line regulation	$I_O = I_{Omax}$		24		60	24		60	mV
	Load regulation	$I_O = 0.1 \dots 1.0 \times I_{Omax}$, $V_I = 26\text{ V}$		24		120	24		120	mV
t_{tr}	Load transient recovery time	$I_O = 0.1 \dots 1.0 \times I_{Omax}$, $V_I = 26\text{ V}$ load step = $0.5 \times I_{Omax}$		300			300			μs
V_{tr}	Load transient voltage			+150			+150			mV
				-150			-150			mV
T_{Ccoeff}	Temperature coefficient	Measured after stabilization		± 0.02			± 0.02			%/ $^\circ\text{C}$
t_r	Ramp-up time	$I_O = 0.1 \dots 1.0 \times I_{Omax}$, $V_I = 26\text{ V}$	$0.1 \dots 0.9 \times V_O$	1.2			1.2			ms
t_s	Start-up time			800		1300	800		1300	ms
I_O	Output current			0.125			0.125			A
P_{Omax}	Max output power			1.5			1.5			W
I_{lim}	Current limiting threshold ¹⁾	$T_C < T_C max$		0.125		0.400	0.125		0.400	A
I_{sc}	Short circuit current	$V_I = 26\text{ V}$		0.35			0.35			A
V_{Oac}	Output ripple & noise	$I_O = I_{Omax}$, $T_A = 25^\circ\text{C}$	DC...20 MHz	60			60			mV _{p-p}
SVR	Supply voltage rejection (ac)	$f = 100/120\text{ Hz sine wave}$, $1 V_{p-p}$, ($SVR = 20 \log(1 V_{p-p}/V_{O-p-p})$)		45			45			dB

¹⁾ At $V_{out} \leq 80\%$ of nominal the power module goes into hick up mode.

Miscellaneous

Efficiency (typ)

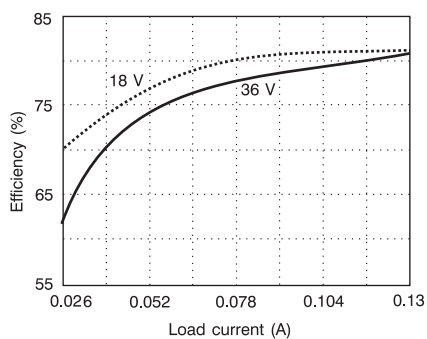

Power derating

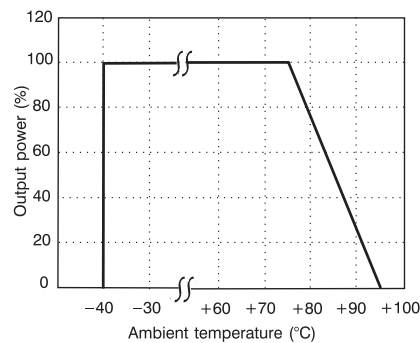

Characteristics		Conditions		min	typ	max	Unit
η	Efficiency	$I_O = I_{Omax}$, $V_I = 26\text{ V}$		73	82		%
P_d	Power dissipation	$I_O = I_{Omax}$, $V_I = 26\text{ V}$			0.66	1.11	W

PKV 3325 PI

Output

$T_A = +25^\circ\text{C}$, $V_I = 9\text{...}36\text{V}$ unless otherwise specified.

Characteristics		Conditions	Output 1			Output 2			Unit
			min	typ	max	min	typ	max	
V_O	Output voltage tolerance band	$I_O=0.1\text{...}1.0 \times I_{O\text{max}}$ and long term drift	+14.7		+15.3	-14.7		-15.3	V
	Line regulation	$I_O=I_{O\text{max}}$		30	75		30	75	mV
	Load regulation	$I_O=0.1\text{...}1.0 \times I_{O\text{max}}$, $V_I = 26\text{ V}$		30	150		30	150	mV
t_{tr}	Load transient recovery time	$I_O=0.1\text{...}1.0 \times I_{O\text{max}}$, $V_I = 26\text{ V}$ load step = $0.5 \times I_{O\text{max}}$		300			300		μs
V_{tr}	Load transient voltage		+200		+200				mV
			-200		-200				mV
T_{coeff}	Temperature coefficient	Measured after stabilization			± 0.02	± 0.02			%/ $^\circ\text{C}$
t_r	Ramp-up time	$I_O=0.1\text{...}1.0 \times I_{O\text{max}}$, $V_I = 26\text{ V}$	$0.1\text{...}0.9 \times V_O$		1.2	1.2		ms	
t_s	Start-up time		From V_I connection to $V_O=0.9 \times V_{O\text{i}}$		800	1300	800	1300	ms
I_O	Output current			0.1			0.1	A	
$P_{O\text{max}}$	Max output power			1.5		1.5		W	
I_{lim}	Current limiting threshold ¹⁾	$T_C < T_{C\text{max}}$	0.10		0.32	0.10		0.32	A
I_{sc}	Short circuit current	$V_I=26\text{ V}$		0.35			0.35		A
$V_{O\text{ac}}$	Output ripple & noise	$I_O=I_{O\text{max}}$, $T_A = 25^\circ\text{C}$	DC...20 MHz		50		50		mV _{p-p}
SVR	Supply voltage rejection (ac)	f = 100/120 Hz sine wave, 1 V _{p-p} , (SVR = $20 \log(1 V_{p-p}/V_{O-p-p})$)			45		45		dB

¹⁾ At $V_{\text{out}} \leq 80\%$ of nominal the power module goes into hick up mode.

Miscellaneous

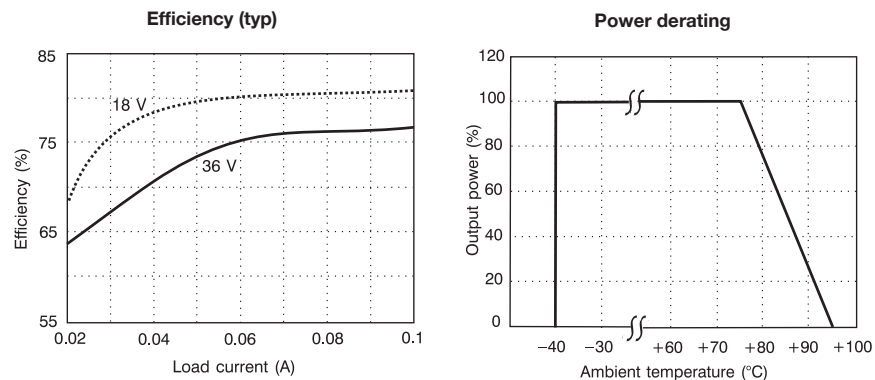

Characteristics		Conditions	min	typ	max	Unit
η	Efficiency	$I_O=I_{O\text{max}}$, $V_I = 26\text{ V}$	76	80		%
P_d	Power dissipation	$I_O=I_{O\text{max}}$, $V_I = 26\text{ V}$		0.75	0.95	W

PKV 5110 PI

Output

$T_A = +25^\circ\text{C}$, $V_I = 18\dots 72\text{V}$ unless otherwise specified.

Characteristics		Conditions		Output 1			Unit
				min	typ	max	
V_O	Output voltage tolerance band	$I_O = 0.1 \dots 1.0 \times I_{Omax}$ and long term drift		3.20		3.40	V
	Line regulation	$I_O = I_{Omax}$			6.6	16.5	mV
	Load regulation	$I_O = 0.1 \dots 1.0 \times I_{Omax}$, $V_I = 53\text{V}$			6.6	33.0	mV
t_{tr}	Load transient recovery time	$I_O = 0.1 \dots 1.0 \times I_{Omax}$, $V_I = 53\text{V}$ load step = $0.5 \times I_{Omax}$			300		μs
V_{tr}	Load transient voltage				+100		mV
					-100		mV
T_{coeff}	Temperature coefficient	Measured after stabilization				± 0.02	%/ $^\circ\text{C}$
t_r	Ramp-up time	$I_O = 0.1 \dots 1.0 \times I_{Omax}$, $V_I = 53\text{V}$	$0.1 \dots 0.9 \times V_O$		0.5		ms
t_s	Start-up time		From V_I connection to $V_O = 0.9 \times V_{Oi}$		900	1300	ms
I_O	Output current					0.5	A
P_{Omax}	Max output power			1.65			W
I_{lim}	Current limiting threshold ¹⁾	$T_C < T_{Cmax}$		0.50		1.62	A
I_{sc}	Short circuit current	$V_I = 53\text{V}$			0.1		A
V_{Oac}	Output ripple & noise	$I_O = I_{Omax}$, $T_A = 25^\circ\text{C}$	DC ... 20 MHz		60		mV _{p-p}
SVR	Supply voltage rejection (ac)	$f = 100/120\text{ Hz sine wave}$, 1 V_{p-p} , ($SVR = 20 \log(1\text{ V}_{p-p}/V_{O(p-p)})$)			60		dB

¹⁾ At $V_{out} \leq 80\%$ of nominal the power module goes into hick up mode.

Miscellaneous

Efficiency (typ)

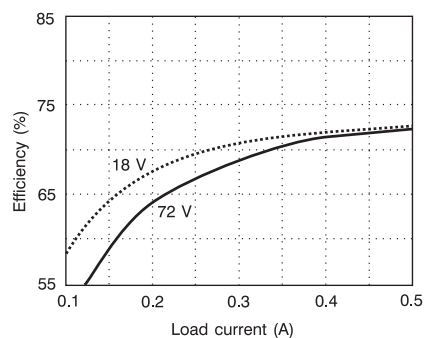

Power derating

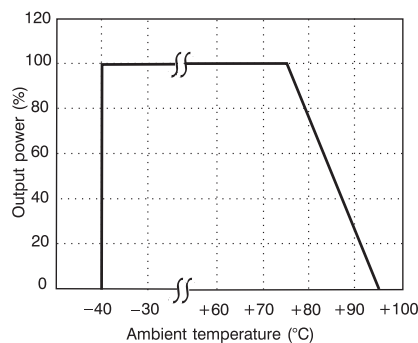

Characteristics		Conditions		min	typ	max	Unit
η	Efficiency	$I_O = I_{Omax}$, $V_I = 53\text{V}$		66	73		%
P_d	Power dissipation	$I_O = I_{Omax}$, $V_I = 53\text{V}$			0.61	0.85	W

PKV 5211 PI

Output

$T_A = +25^\circ\text{C}$, $V_I = 18...72\text{V}$ unless otherwise specified.

Characteristics		Conditions	Output 1			Unit
			min	typ	max	
V_O	Output voltage tolerance band	$I_O = 0.1 \dots 1.0 \times I_{O\max}$ and long term drift	4.90		5.10	V
	Line regulation	$I_O = I_{O\max}$		10	25	mV
	Load regulation	$I_O = 0.1 \dots 1.0 \times I_{O\max}$, $V_I = 53\text{V}$		10	50	mV
t_{tr}	Load transient recovery time	$I_O = 0.1 \dots 1.0 \times I_{O\max}$, $V_I = 53\text{V}$ load step = $0.5 \times I_{O\max}$		300		μs
V_{tr}	Load transient voltage			+100		mV
					-100	
T_{coeff}	Temperature coefficient	Measured after stabilization			± 0.02	$\%/^\circ\text{C}$
t_r	Ramp-up time	$I_O = 0.1 \dots 1.0 \times I_{O\max}$, $V_I = 53\text{V}$	$0.1 \dots 0.9 \times V_O$		0.5	ms
t_s	Start-up time		From V_I connection to $V_O = 0.9 \times V_{O1}$		900	1300
I_O	Output current				0.5	A
$P_{O\max}$	Max output power		2.5			W
I_{lim}	Current limiting threshold ¹⁾	$T_C < T_{C\max}$	0.5		1.62	A
I_{sc}	Short circuit current	$V_I = 53\text{V}$		0.12		A
V_{Oac}	Output ripple & noise	$I_O = I_{O\max}$, $T_A = 25^\circ\text{C}$	DC... 20 MHz		60	mV _{p-p}
SVR	Supply voltage rejection (ac)	$f = 100/120\text{ Hz sine wave}$, $1 V_{p-p}$, ($\text{SVR} = 20 \log(1 V_{p-p}/V_{O\text{p-p}})$)		60		dB

¹⁾ At $V_{\text{out}} \leq 80\%$ of nominal the power module goes into hiccup mode.

Miscellaneous

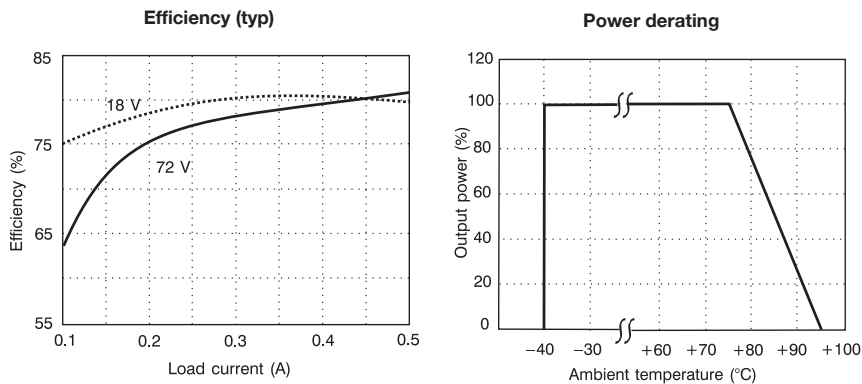

Characteristics		Conditions	min	typ	max	Unit
η	Efficiency	$I_O = I_{O\max}$, $V_I = 53\text{V}$	75	82		%
P_d	Power dissipation	$I_O = I_{O\max}$, $V_I = 53\text{V}$		0.55	0.84	W

PKV 5313 PI

Output

$T_A = +25^\circ\text{C}$, $V_I = 18...72\text{V}$ unless otherwise specified.

Characteristics		Conditions		Output 1			Unit
				min	typ	max	
V_O	Output voltage tolerance band	$I_O = 0.1 \dots 1.0 \times I_{Omax}$ and long term drift		11.76		12.24	V
	Line regulation	$I_O = I_{Omax}$			24	60	mV
	Load regulation	$I_O = 0.1 \dots 1.0 \times I_{Omax}$, $V_I = 53\text{V}$			24	120	mV
t_{tr}	Load transient recovery time	$I_O = 0.1 \dots 1.0 \times I_{Omax}$, $V_I = 53\text{V}$ load step = $0.5 \times I_{Omax}$			300		μs
V_{tr}	Load transient voltage				+150		mV
					-150		mV
T_{coeff}	Temperature coefficient	Measured after stabilization				± 0.02	$\%/^\circ\text{C}$
t_r	Ramp-up time	$I_O = 0.1 \dots 1.0 \times I_{Omax}$, $V_I = 53\text{V}$	$0.1 \dots 0.9 \times V_O$		1.2		ms
t_s	Start-up time		From V_I connection to $V_O = 0.9 \times V_{OI}$		900	1300	ms
I_O	Output current					0.25	A
P_{Omax}	Max output power			3			W
I_{lim}	Current limiting threshold ¹⁾	$T_C < T_{Cmax}$		0.25		0.81	A
I_{sc}	Short circuit current	$V_I = 53\text{V}$			0.17		A
V_{Oac}	Output ripple & noise	$I_O = I_{Omax}$, $T_A = 25^\circ\text{C}$	DC... 20 MHz		60		mV _{p-p}
SVR	Supply voltage rejection (ac)	$f = 100/120\text{ Hz sine wave}$, $1 V_{p-p}$, ($SVR = 20 \log(1 V_{p-p}/V_{O-p-p})$)			60		dB

¹⁾ At $V_{out} \leq 80\%$ of nominal the power module goes into hick up mode.

Miscellaneous

Efficiency (typ)

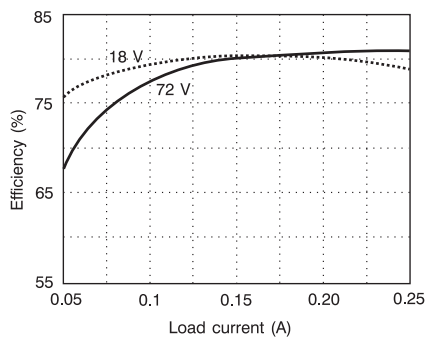

Power derating

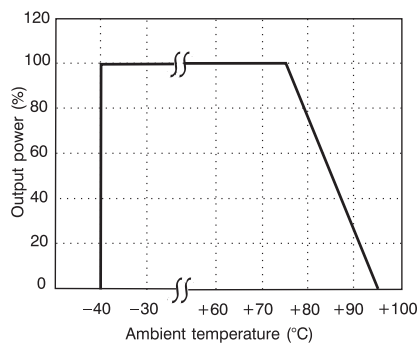

Characteristics		Conditions	min	typ	max	Unit
η	Efficiency	$I_O = I_{Omax}$, $V_I = 53\text{V}$	76	82		%
P_d	Power dissipation	$I_O = I_{Omax}$, $V_I = 53\text{V}$		0.66	0.95	W

PKV 5315 PI

Output

$T_A = +25^\circ\text{C}$, $V_I = 18...72\text{V}$ unless otherwise specified.

Characteristics		Conditions		Output 1			Unit	
				min	typ	max		
V_O	Output voltage tolerance band	$I_O = 0.1 \dots 1.0 \times I_{Omax}$ and long term drift		14.7		15.3	V	
	Line regulation	$I_O = I_{Omax}$			30	75	mV	
	Load regulation	$I_O = 0.1 \dots 1.0 \times I_{Omax}$, $V_I = 53\text{V}$			30	150	mV	
t_{tr}	Load transient recovery time	$I_O = 0.1 \dots 1.0 \times I_{Omax}$, $V_I = 53\text{V}$ load step = $0.5 \times I_{Omax}$			300		μs	
V_{tr}	Load transient voltage				+200			mV
						-200		
T_{coeff}	Temperature coefficient	Measured after stabilization				± 0.02	$\% / ^\circ\text{C}$	
t_r	Ramp-up time	$I_O = 0.1 \dots 1.0 \times I_{Omax}$, $V_I = 53\text{V}$	$0.1 \dots 0.9 \times V_O$		1.2		ms	
t_s	Start-up time		From V_I connection to $V_O = 0.9 \times V_{O1}$		900	1300		ms
I_O	Output current					0.2	A	
P_{Omax}	Max output power			3			W	
I_{lim}	Current limiting threshold ¹⁾	$T_C < T_{Cmax}$		0.20		0.65	A	
I_{sc}	Short circuit current	$V_I = 53\text{V}$			0.17		A	
V_{Oac}	Output ripple & noise	$I_O = I_{Omax}$, $T_A = 25^\circ\text{C}$	DC... 20 MHz		60		mV _{p-p}	
SVR	Supply voltage rejection (ac)	$f = 100/120\text{ Hz sine wave}$, $1 V_{p-p}$, ($SVR = 20 \log(1 V_{p-p}/V_{O p-p})$)			60		dB	

¹⁾ At $V_{out} \leq 80\%$ of nominal the power module goes into hick up mode.

Miscellaneous

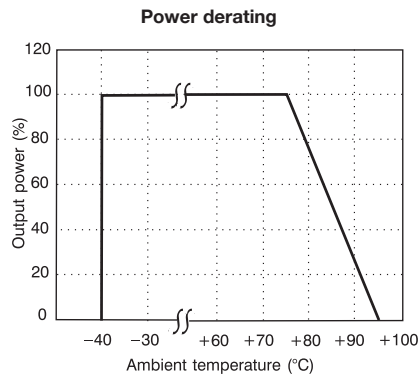
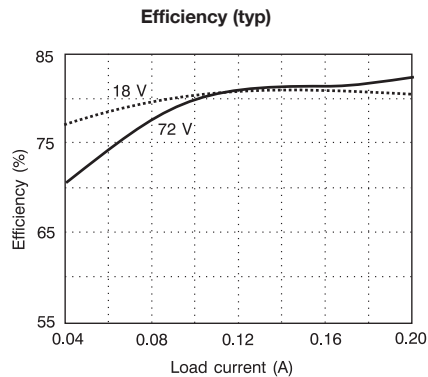

Characteristics		Conditions	min	typ	max	Unit
η	Efficiency	$I_O = I_{Omax}$, $V_I = 53\text{V}$	76	82		%
P_d	Power dissipation	$I_O = I_{Omax}$, $V_I = 53\text{V}$		0.66	0.95	W

PKV 5222 PI

Output

$T_A = +25^\circ\text{C}$, $V_I = 18\text{...}72\text{V}$ unless otherwise specified.

Characteristics		Conditions	Output 1			Output 2			Unit
			min	typ	max	min	typ	max	
V_O	Output voltage tolerance band	$I_O=0.1\text{...}1.0 \times I_{O\text{max}}$ and long term drift	+4.9		+5.1	-4.9		-5.1	V
	Line regulation	$I_O=I_{O\text{max}}$		10	25		10	25	mV
	Load regulation	$I_O=0.1\text{...}1.0 \times I_{O\text{max}}$, $V_I = 53\text{ V}$		10	50		10	50	mV
t_{tr}	Load transient recovery time	$I_O=0.1\text{...}1.0 \times I_{O\text{max}}$, $V_I = 53\text{ V}$ load step = $0.5 \times I_{O\text{max}}$		300			300		μs
V_{tr}	Load transient voltage		+100		+100				mV
			-100		-100				mV
T_{coeff}	Temperature coefficient	Measured after stabilization			± 0.02			$\% / ^\circ\text{C}$	
t_r	Ramp-up time	$I_O=0.1\text{...}1.0 \times I_{O\text{max}}$, $V_I = 53\text{ V}$	$0.1\text{...}0.9 \times V_O$		1.2		1.2		ms
t_s	Start-up time		From V_I connection to $V_O = 0.9 \times V_{OI}$		900 1300		900 1300		ms
I_O	Output current		0.25		0.25		0.25		A
$P_{O\text{max}}$	Max output power		1.25		1.25		1.25		W
I_{lim}	Current limiting threshold ¹⁾	$T_C < T_{C\text{max}}$	0.25		0.81		0.25 0.81		A
I_{sc}	Short circuit current	$V_I = 53\text{ V}$	0.12		0.12		0.12		A
$V_{O\text{ac}}$	Output ripple & noise	$I_O=I_{O\text{max}}$, $T_A = 25^\circ\text{C}$	DC...20 MHz		60		60		mV _{p-p}
SVR	Supply voltage rejection (ac)	$f = 100/120\text{ Hz}$ sine wave, 1 V_{p-p} , ($\text{SVR} = 20 \log(1\text{ V}_{p-p}/V_{O\text{p-p}})$)		45		45		dB	

¹⁾ At $V_{\text{out}} \leq 80\%$ of nominal the power module goes into hick up mode.

Miscellaneous

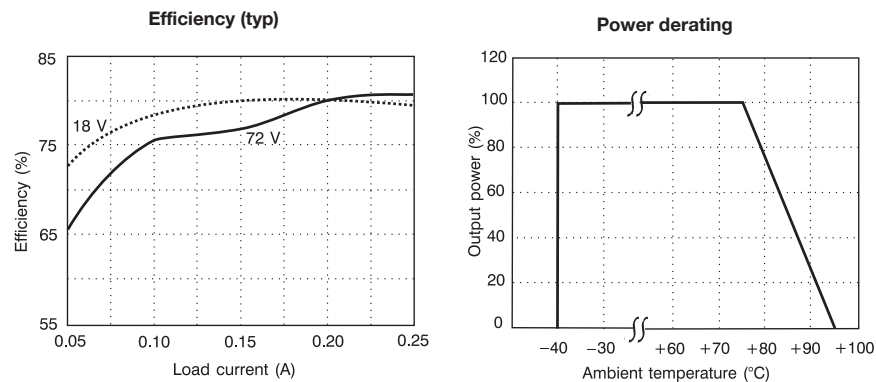

Characteristics		Conditions	min	typ	max	Unit
η	Efficiency	$I_O = I_{O\text{max}}$, $V_I = 53\text{ V}$	75	82		%
P_d	Power dissipation	$I_O = I_{O\text{max}}$, $V_I = 53\text{ V}$		0.55	0.83	W

PKV 5321 PI

Output

$T_A = +25^\circ\text{C}$, $V_I = 18...72\text{V}$ unless otherwise specified.

Characteristics		Conditions	Output 1			Output 2			Unit
			min	typ	max	min	typ	max	
V_O	Output voltage tolerance band	$I_O = 0.1 \dots 1.0 \times I_{O\text{max}}$ and long term drift	+11.76		+12.24	-11.76		-12.24	V
	Line regulation	$I_O = I_{O\text{max}}$		24	60		24	60	mV
	Load regulation	$I_O = 0.1 \dots 1.0 \times I_{O\text{max}}$, $V_I = 53\text{V}$		24	120		24	120	mV
t_{tr}	Load transient recovery time	$I_O = 0.1 \dots 1.0 \times I_{O\text{max}}$, $V_I = 53\text{V}$ load step = $0.5 \times I_{O\text{max}}$		300			300		μs
V_{tr}	Load transient voltage		+150		+150				mV
			-150		-150				mV
T_{coeff}	Temperature coefficient	Measured after stabilization			± 0.02			± 0.02	$\% / ^\circ\text{C}$
t_r	Ramp-up time	$I_O = 0.1 \dots 1.0 \times I_{O\text{max}}$, $V_I = 53\text{V}$	$0.1 \dots 0.9 \times V_O$		1.2	1.2		ms	
t_s	Start-up time		From V_I connection to $V_O = 0.9 \times V_{O1}$		900	1300	900	1300	ms
I_O	Output current			0.125			0.125	A	
$P_{O\text{max}}$	Max output power			1.5			1.5	W	
I_{lim}	Current limiting threshold ¹⁾	$T_C < T_{C\text{max}}$	0.125		0.400	0.125		0.400	A
I_{sc}	Short circuit current	$V_I = 53\text{V}$		0.17			0.17	A	
$V_{O\text{ac}}$	Output ripple & noise	$I_O = I_{O\text{max}}$, $T_A = 25^\circ\text{C}$	DC...20 MHz		60		60	mV _{p-p}	
SVR	Supply voltage rejection (ac)	$f = 100/120\text{ Hz sine wave}$, $1 V_{p-p}$, ($\text{SVR} = 20 \log(1 V_{p-p}/V_{O\text{p-p}})$)		45			45	dB	

¹⁾ At $V_{\text{out}} \leq 80\%$ of nominal the power module goes into hick up mode.

Miscellaneous

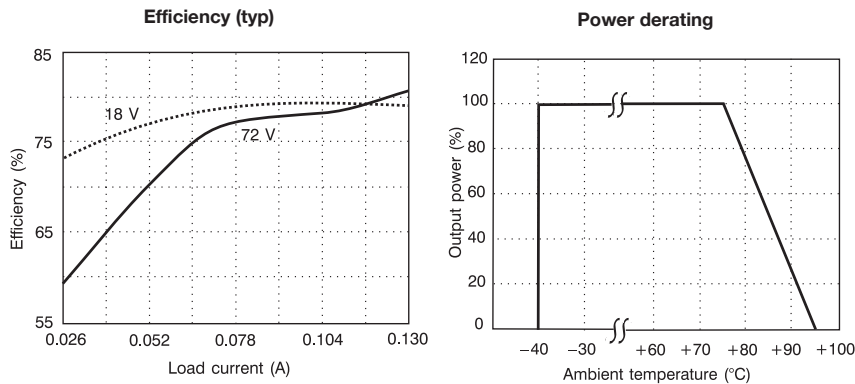

Characteristics		Conditions	min	typ	max	Unit
η	Efficiency	$I_O = I_{O\text{max}}$, $V_I = 53\text{V}$	73	82		%
P_d	Power dissipation	$I_O = I_{O\text{max}}$, $V_I = 53\text{V}$		0.66	1.11	W

PKV 5325 PI

Output

$T_A = +25^\circ\text{C}$, $V_I = 18...72\text{V}$ unless otherwise specified.

Characteristics		Conditions	Output 1			Output 2			Unit
			min	typ	max	min	typ	max	
V_O	Output voltage tolerance band	$I_O=0.1 \dots 1.0 \times I_{Omax}$ and long term drift	+14.7		+15.3	-14.7		-15.3	V
	Line regulation	$I_O=I_{Omax}$		30	75		30	75	mV
	Load regulation	$I_O=0.1 \dots 1.0 \times I_{Omax}$, $V_I = 53\text{ V}$		30	150		30	150	mV
t_{tr}	Load transient recovery time	$I_O= 0.1 \dots 1.0 \times I_{Omax}$, $V_I = 53\text{ V}$ load step = $0.5 \times I_{Omax}$		300			300		μs
V_{tr}	Load transient voltage		+200		+200		+200		mV
			-200		-200		-200		mV
T_{coeff}	Temperature coefficient	Measured after stabilization			± 0.02		± 0.02	$\% / ^\circ\text{C}$	
t_r	Ramp-up time	$I_O= 0.1 \dots 1.0 \times I_{Omax}$, $V_I = 53\text{ V}$	$0.1 \dots 0.9 \times V_O$		1.2		1.2		ms
t_s	Start-up time		From V_I connection to $V_O = 0.9 \times V_{OI}$		900	1300	900	1300	ms
I_O	Output current			0.1		0.1		A	
P_{Omax}	Max output power			1.5		1.5		W	
I_{lim}	Current limiting threshold ¹⁾	$T_C < T_{Cmax}$		0.10	0.32		0.10	0.32	A
I_{sc}	Short circuit current	$V_I = 53\text{ V}$		0.17			0.17		A
V_{Oac}	Output ripple & noise	$I_O=I_{Omax}$, $T_A = 25^\circ\text{C}$	DC...20 MHz		60		60		mV _{p-p}
SVR	Supply voltage rejection (ac)	$f = 100/120\text{ Hz}$ sine wave, $1 V_{p-p}$, ($SVR = 20 \log(1 V_{p-p}/V_{O-p-p})$)		45		45		dB	

¹⁾ At $V_{out} \leq 80\%$ of nominal the power module goes into hick up mode.

Miscellaneous

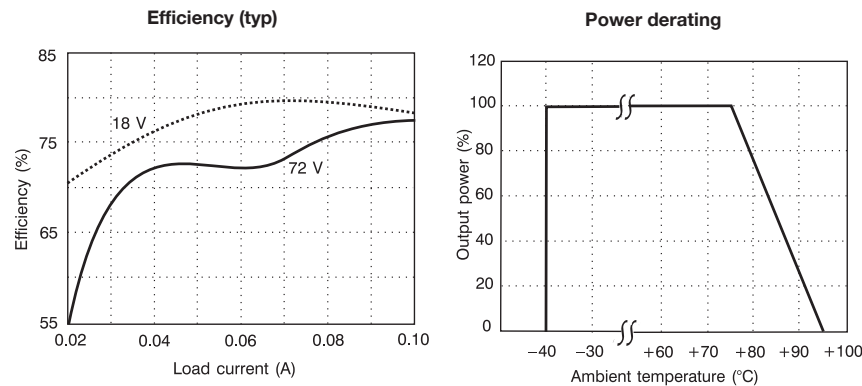

Characteristics		Conditions	min	typ	max	Unit
η	Efficiency	$I_O= I_{Omax}$, $V_I = 53\text{ V}$	76	82		%
P_d	Power dissipation	$I_O= I_{Omax}$, $V_I = 53\text{ V}$		0.66	0.95	W

EMC Specifications

The PKV DC/DC power module is mounted on a double sided printed circuit board (PB) with groundplane during EMC measurements. The fundamental switching frequency is approx. 200 kHz.

The PKV series has a good input filter and will only need a simple filter to meet conducted noise according to EN 55022 level B. Fig. 1 shows an example of filter and the results for this filter is shown below.

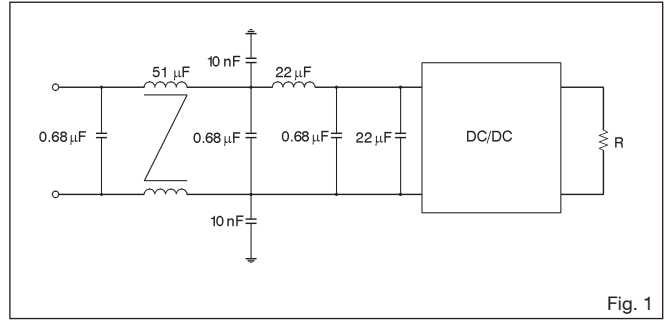
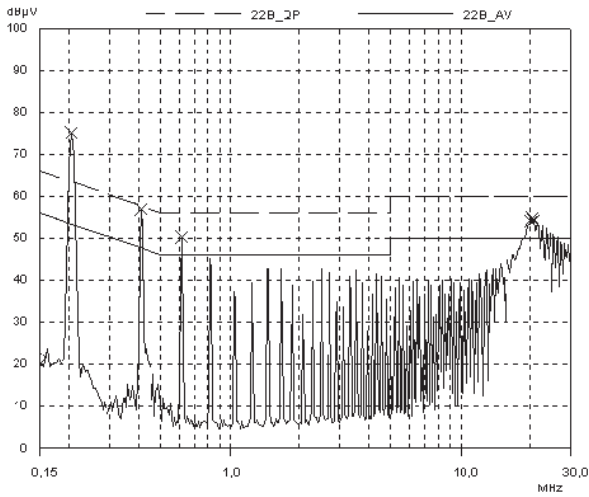
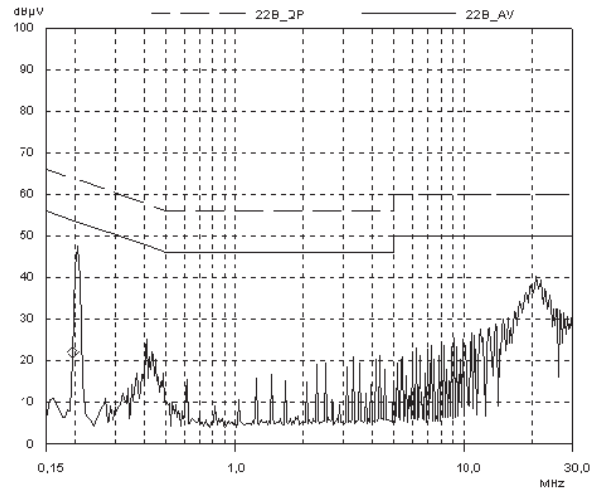

Fig. 1

Conducted noise



PKV 3211 without filter



PKV 3211 with filter

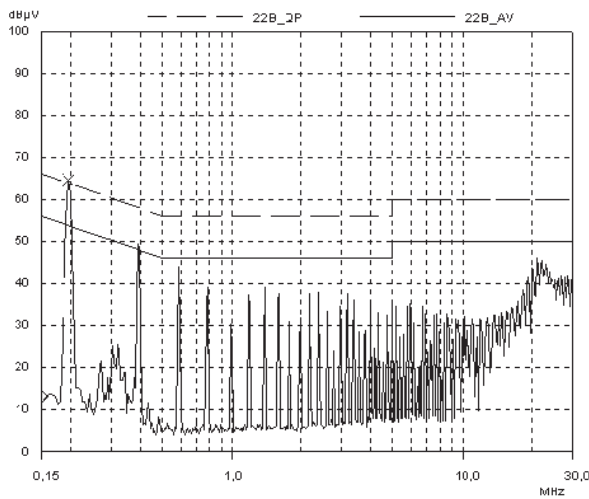

PKV 5211 without filter

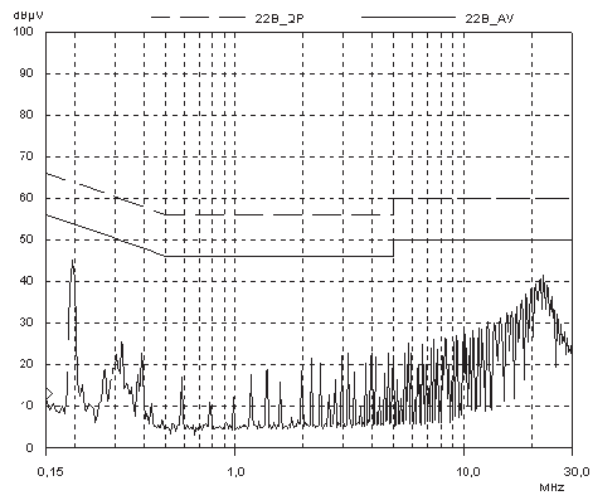

PKV 5211 with filter

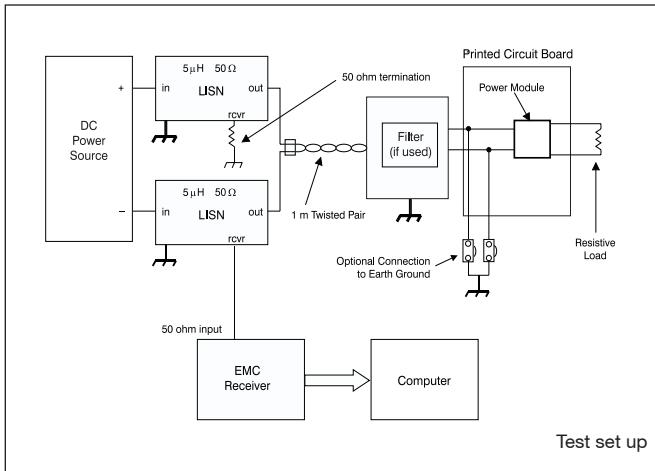

Delivery Package Information

The PKV series DC/DC converters are delivered in tubes with a length of 384 mm (15.1 in)

Tube Specification

Material:	PVC
Max surface resistance:	10 to 1000 MOhm/sq
Color:	Transparent
Capacity:	10 pcs/tube
Weight:	typ 160 g
End stops:	Pins

Reliability

According to MIL-HDBK-217F the calculated MTBF value at 100% load (from PKV 5211 PI) at the following ambient temperatures will be approx.:

Tamb	Hours
0 °C	2.7 million
10 °C	1.5 million
25 °C	650 000
40 °C	276 000
60 °C	88 000
75 °C	37 000

At 80–100% load the case temperature will be approx. 15–20 °C higher than the ambient temperature.

Compatibility with RoHS requirements

The products are compatible with the relevant clauses and requirements of the RoHS directive 2002/95/EC and have a maximum concentration value of 0.1% by weight in homogeneous materials for lead, mercury, hexavalent chromium, PBB and PBDE and of 0.01% by weight in homogeneous materials for cadmium.

Exemptions in the RoHS directive utilized in Ericsson Power Modules products include:

- Lead in high melting temperature type solder (used to solder the die in semiconductor packages)
- Lead in glass of electronics components and in electronic ceramic parts (e.g. fill material in chip resistors)
- Lead as an alloying element in copper alloy containing up to 4% lead by weight (used in connection pins made of Brass)

Miscellaneous

Soldering Information

The PKV Series DC/DC Converters are intended for through hole mounting in a PCB. When wave soldering is used, the temperature on the pins is specified to maximum 260 °C for maximum 10 seconds. Maximum preheat rate of 4 °C/s and temperature of max 150 °C is suggested. When hand soldering, care should be taken to avoid direct contact between the hot soldering iron tip and the pins for more than a few seconds in order to prevent overheating.

A no-clean (NC) flux is recommended to avoid entrapment of cleaning fluids in cavities inside of the DC/DC power module. The residues may affect long time reliability and isolation voltage.

External Decoupling Capacitors

When powering loads with significant dynamic current requirements, the voltage regulation at the point of load can be improved by addition of decoupling capacitors at the load. The most effective technique is to locate low ESR ceramic and electrolytic capacitors as close to the load as possible, using several parallel capacitors to lower the effective ESR. The ceramic capacitors will handle high-frequency dynamic load changes while the electrolytic capacitors are used to handle low frequency dynamic load changes. Ceramic capacitors will also reduce any high frequency noise at the load. It is equally important to use low resistance and low inductance PCB layouts and cabling.

External decoupling capacitors will become part of the control loop of the DC/DC converter and may affect the stability margins. As a “rule of thumb”, 100 µF/A of output current can be added without any additional analysis. The ESR of the capacitors is a very important parameter. Power Modules guarantee stable operation with a verified ESR value of >10W across the output connections.

For further information please contact your local Ericsson Power Modules representative.

Quality Statement

The PKV series DC/DC converters are designed and manufactured in an industrial environment where quality systems and methods like ISO 9000 and SPC are intensively in use to boost the continuous improvements strategy. Infant mortality or early failures in the products are screened out by a burn-in procedure.

Warranty

Warranty period and conditions are defined in Ericsson Power Modules General Terms and Conditions of Sale.

Limitation of liability

Ericsson Power Modules does not make any other warranties, expressed or implied including any warranty of merchantability or fitness for a particular purpose (including, but not limited to, use in life support applications, where malfunctions of product can cause injury to a person's health or life).

Product Program

V_i	V_o/I_o max	P_o max	Ordering No.
12/24 V	3.3 V/500 mA	1.65 W	PKV 3110 PI
	5 V/500 mA	2.50 W	PKV 3211 PI
	12 V/250 mA	3.00 W	PKV 3313 PI
	15 V/200 mA	3.00 W	PKV 3315 PI
	± 5V/250 mA	2.50 W	PKV 3222 PI
	±12V/125 mA	3.00 W	PKV 3321 PI
	±15V/100 mA	3.00 W	PKV 3325 PI
48/60 V	3.3 V/500 mA	1.65 W	PKV 5110 PI
	5 V/500 mA	2.50 W	PKV 5211 PI
	12 V/250 mA	3.00 W	PKV 5313 PI
	15 V/200 mA	3.00 W	PKV 5315 PI
	± 5 V/250 mA	2.50 W	PKV 5222 PI
	±12 V/125 mA	3.00 W	PKV 5321 PI
	±15 V/100 mA	3.00 W	PKV 5325 PI

Information given in this data sheet is believed to be accurate and reliable. No responsibility is assumed for the consequences of its use nor for any infringement of patents or other rights of third parties which may result from its use. No license is granted by implication or otherwise under any patent or patent rights of Ericsson Power Modules. These products are sold only according to Ericsson Power Modules' general conditions of sale, unless otherwise confirmed in writing. Specifications subject to change without notice.

Ericsson Power Modules

SE-126 25 Stockholm, Sweden
Telephone: +46 8 568 69620

For local sales contacts, please refer to our website
www.ericsson.com/powermodules
or call: Int +46 8 568 69620, Fax: +46 8 568 69599

Americas

Ericsson Inc., Power Modules
+1-972-583-5224, +1-972-583-6910

Asia/Pacific

Ericsson Ltd.
+852-2590-2453

The latest and most complete information can be found on our website.

Datasheet

EN/LZT 146 37 R3A
© Ericsson Power Modules AB, March 2007

Mouser Electronics

Authorized Distributor

Click to View Pricing, Inventory, Delivery & Lifecycle Information:

[Ericsson Power Modules:](#)

[PKV3211PI](#) [PKV3313PI](#) [PKV3315PI](#) [PKV3222PI](#) [PKV3321PI](#) [PKV3325PI](#) [PKV5110PI](#) [PKV5211PI](#) [PKV5313PI](#)
[PKV5315PI](#) [PKV5222PI](#) [PKV5321PI](#) [PKV5325PI](#) [PKV3110PI](#)