

Description

The 6706A uses advanced trench technology and design to provide excellent $R_{DS(ON)}$ with low gate charge. It can be used to form a level shifted high side switch, and for a host of other applications.

General Features

● N-Channel

V_{DSS}	$R_{DS(ON)}$ @ 10V (typ)	I_D
30V	20 mΩ	6.5A

● P-Channel

V_{DSS}	$R_{DS(ON)}$ @ 10V (typ)	I_D
-30V	42 mΩ	-5A

- High power and current handing capability
- Lead free product is acquired
- Surface mount package

Application

- PWM applications
- Load switch
- Power management

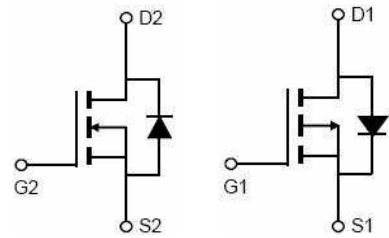

N-channel P-channel

Schematic diagram

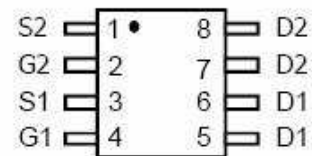

Marking and pin assignment

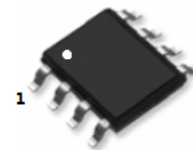

SOP-8

Absolute Maximum Ratings ($T_A=25^\circ\text{C}$ unless otherwise noted)

Parameter	Symbol	N-Channel	P-Channel	Unit	
Drain-Source Voltage	V_{DS}	30	-30	V	
Gate-Source Voltage	V_{GS}	± 20	± 20	V	
Drain Current-Continuous	I_D	$T_A=25^\circ\text{C}$	6.5	-5	A
		$T_A=70^\circ\text{C}$	5.4	-4.1	A
Drain Current-Pulsed ^(Note 1)	I_{DM}	26	-20	A	
Maximum Power Dissipation	P_D	2.0	2.0	W	
Operating Junction and Storage Temperature Range	T_J, T_{STG}	-55 To 150	-55 To 150	$^\circ\text{C}$	

Thermal Characteristic

Thermal Resistance, Junction-to-Ambient ^(Note 2)	$R_{\theta JA}$	N-Ch	62.5	$^\circ\text{C/W}$
Thermal Resistance, Junction-to-Ambient (Note 2)	$R_{\theta JA}$	P-Ch	62.5	$^\circ\text{C/W}$

N-CH Electrical Characteristics (T_A=25°C unless otherwise noted)

Parameter	Symbol	Condition	Min	Typ	Max	Unit
Off Characteristics						
Drain-Source Breakdown Voltage	BV _{DSS}	V _{GS} =0V I _D =250μA	30	33	-	V
Zero Gate Voltage Drain Current	I _{DSS}	V _{DS} =30V, V _{GS} =0V	-	-	1	μA
Gate-Body Leakage Current	I _{GSS}	V _{GS} =±20V, V _{DS} =0V	-	-	±100	nA
On Characteristics (Note 3)						
Gate Threshold Voltage	V _{GS(th)}	V _{DS} =V _{GS} , I _D =250μA	1.2	1.6	2.4	V
Drain-Source On-State Resistance	R _{DS(ON)}	V _{GS} =10V, I _D =5A	-	20	30	mΩ
Drain-Source On-State Resistance	R _{DS(ON)}	V _{GS} =4.5V, I _D =5A	-	30	40	mΩ
Forward Transconductance	g _{FS}	V _{DS} =5V, I _D =5A	-	15	-	S
Dynamic Characteristics (Note 4)						
Input Capacitance	C _{iss}	V _{DS} =15V, V _{GS} =0V, F=1.0MHz	-	255	-	PF
Output Capacitance	C _{oss}		-	45	-	PF
Reverse Transfer Capacitance	C _{rss}		-	35	-	PF
Switching Characteristics (Note 4)						
Turn-on Delay Time	t _{d(on)}	V _{DD} =15V, R _L =2.5Ω V _{GS} =10V, R _G =3Ω	-	4.5	-	nS
Turn-on Rise Time	t _r		-	2.5	-	nS
Turn-Off Delay Time	t _{d(off)}		-	14.5	-	nS
Turn-Off Fall Time	t _f		-	3.5	-	nS
Total Gate Charge	Q _g	V _{DS} =15V, I _D =5A, V _{GS} =10V	-	5.2	-	nC
Gate-Source Charge	Q _{gs}		-	0.85	-	nC
Gate-Drain Charge	Q _{gd}		-	1.3	-	nC
Drain-Source Diode Characteristics						
Diode Forward Voltage (Note 3)	V _{SD}	V _{GS} =0V, I _S =5A	-	-	1.2	V

P-CH Electrical Characteristics ($T_A=25^{\circ}\text{C}$ unless otherwise noted)

Parameter	Symbol	Condition	Min	Typ	Max	Unit
Off Characteristics						
Drain-Source Breakdown Voltage	BV_{DSS}	$V_{GS}=0V, I_D=-250\mu A$	-30	-33	-	V
Zero Gate Voltage Drain Current	I_{DSS}	$V_{DS}=-30V, V_{GS}=0V$	-	-	-1	μA
Gate-Body Leakage Current	I_{GSS}	$V_{GS}=\pm 20V, V_{DS}=0V$	-	-	± 100	nA
On Characteristics (Note 3)						
Gate Threshold Voltage	$V_{GS(th)}$	$V_{DS}=V_{GS}, I_D=-250\mu A$	-1	-1.6	-2.5	V
Drain-Source On-State Resistance	$R_{DS(ON)}$	$V_{GS}=-10V, I_D=-4A$	-	42	60	m Ω
Drain-Source On-State Resistance	$R_{DS(ON)}$	$V_{GS}=-4.5V, I_D=-4A$	-	62	90	m Ω
Forward Transconductance	g_{FS}	$V_{DS}=-5V, I_D=-5A$	-	8	-	S
Dynamic Characteristics (Note 4)						
Input Capacitance	C_{iss}	$V_{DS}=-15V, V_{GS}=0V,$ $F=1.0\text{MHz}$	-	520	-	PF
Output Capacitance	C_{oss}		-	100	-	PF
Reverse Transfer Capacitance	C_{rss}		-	65	-	PF
Switching Characteristics (Note 4)						
Turn-on Delay Time	$t_{d(on)}$	$V_{DD}=-15V, R_L=2.3\Omega$ $V_{GS}=-10V, R_G=6\Omega$	-	7.5	-	nS
Turn-on Rise Time	t_r		-	5.5	-	nS
Turn-Off Delay Time	$t_{d(off)}$		-	19	-	nS
Turn-Off Fall Time	t_f		-	7	-	nS
Total Gate Charge	Q_g	$V_{DS}=-15V, I_D=-5A,$ $V_{GS}=-10V$	-	9.2	-	nC
Gate-Source Charge	Q_{gs}		-	1.6	-	nC
Gate-Drain Charge	Q_{gd}		-	2.2	-	nC
Drain-Source Diode Characteristics						
Diode Forward Voltage (Note 3)	V_{SD}	$V_{GS}=0V, I_S=-5A$	-	-	-1.2	V

Notes:

1. Repetitive Rating: Pulse width limited by maximum junction temperature.
2. Surface Mounted on FR4 Board, $t \leq 10$ sec.
3. Pulse Test: Pulse Width $\leq 300\mu s$, Duty Cycle $\leq 2\%$.
4. Guaranteed by design, not subject to production

N-Channel Typical Electrical and Thermal Characteristics (Curves)

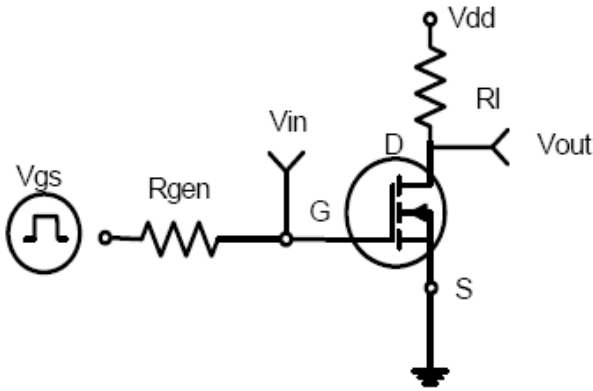

Figure 1 Switching Test Circuit

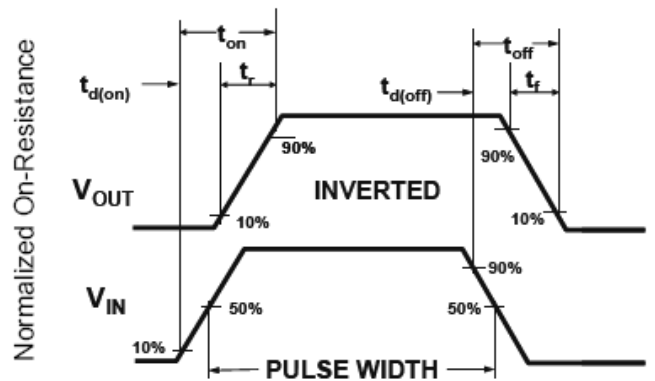

Figure 2 Switching Waveforms

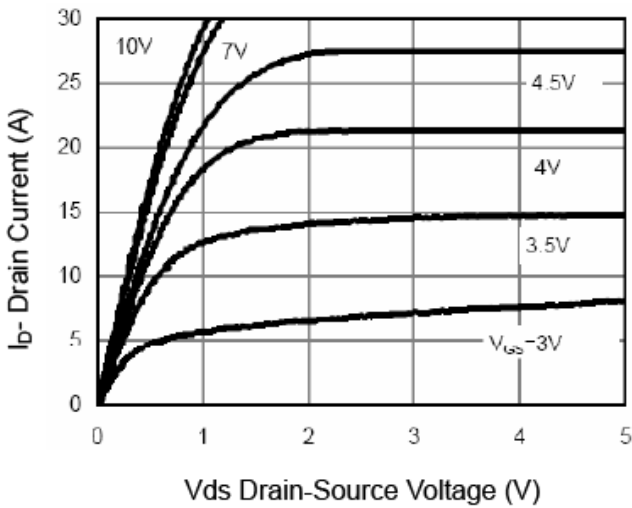

Figure 3 Output Characteristics

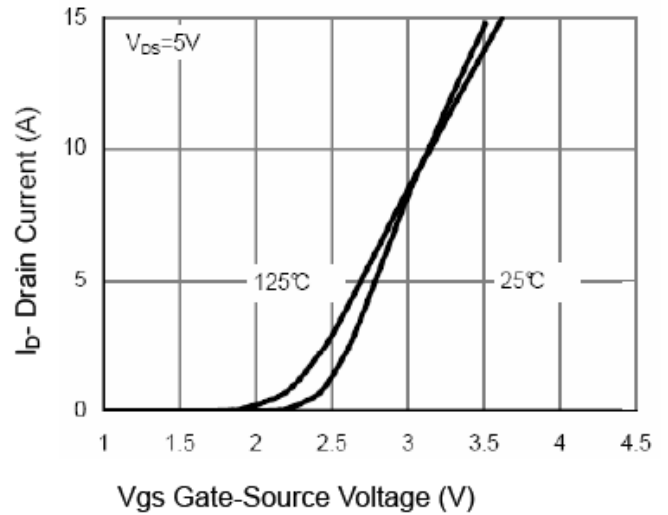

Figure 4 Transfer Characteristics

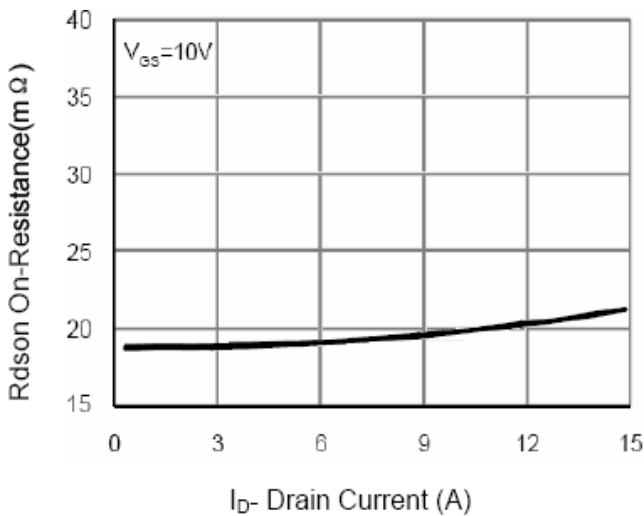

Figure 5 Rdson- Drain Current

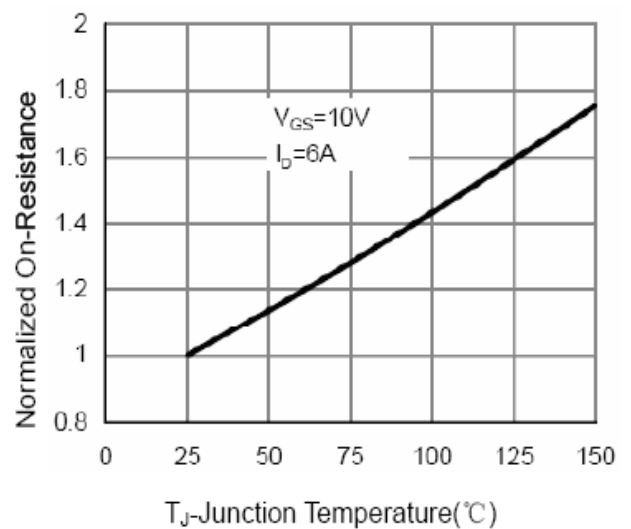

Figure 6 Source- Drain Diode Forward

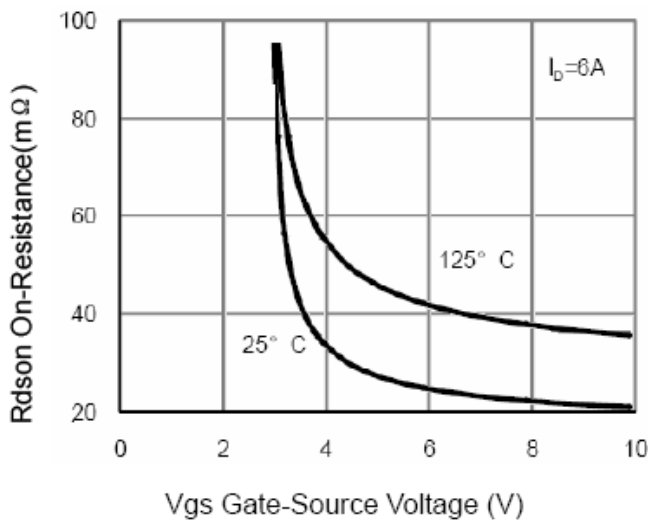

Figure 7 Rdson vs Vgs

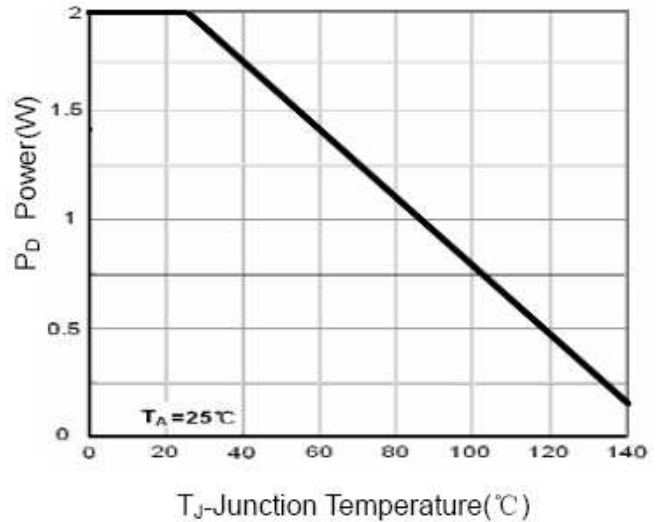

Figure 8 Power Dissipation

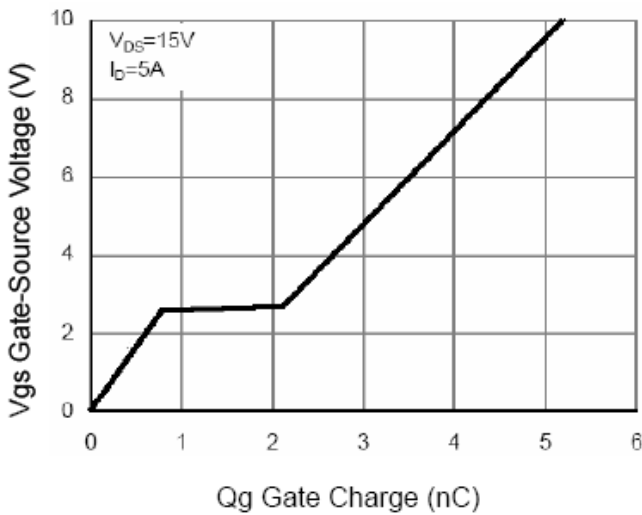

Figure 8 Gate Charge

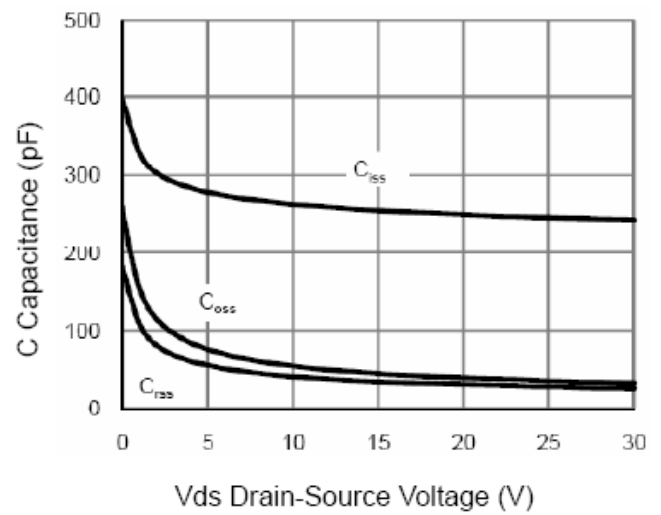

Figure 9 Capacitance vs Vds

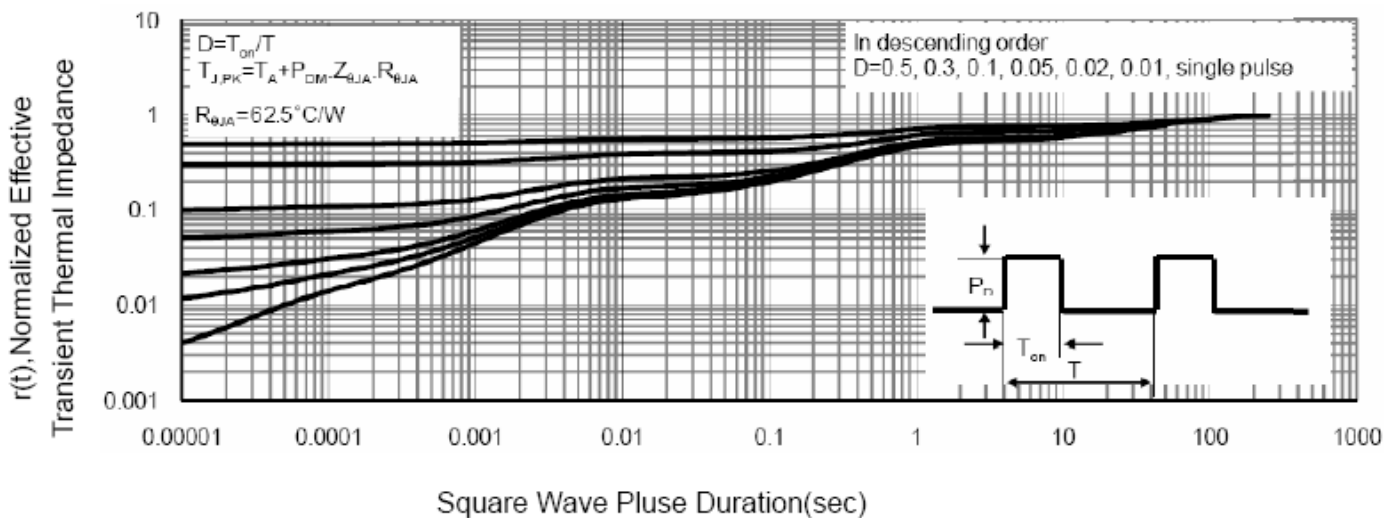

Figure 10 Normalized Maximum Transient Thermal Impedance

P-Channel Typical Electrical and Thermal Characteristics (Curves)

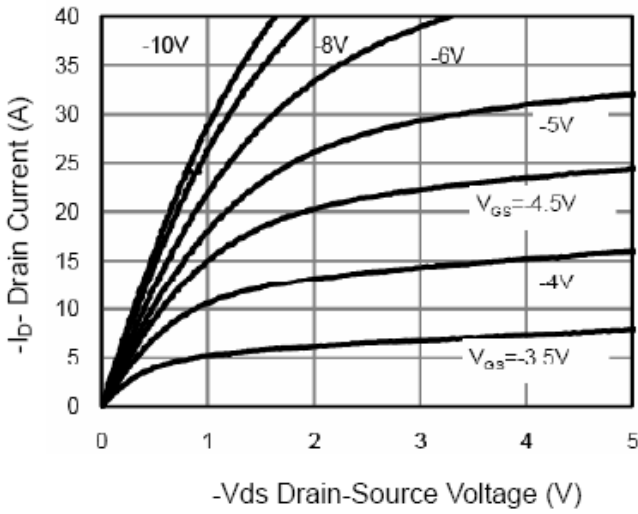

Figure 1 Output Characteristics

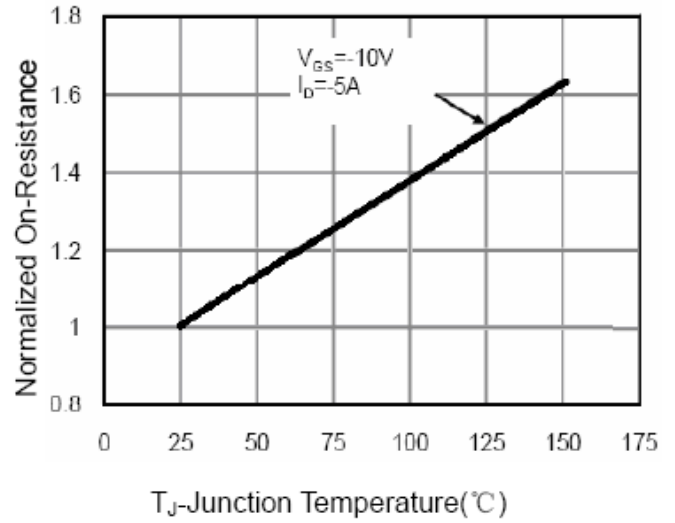

Figure 2 R_{dson} -Junction Temperature

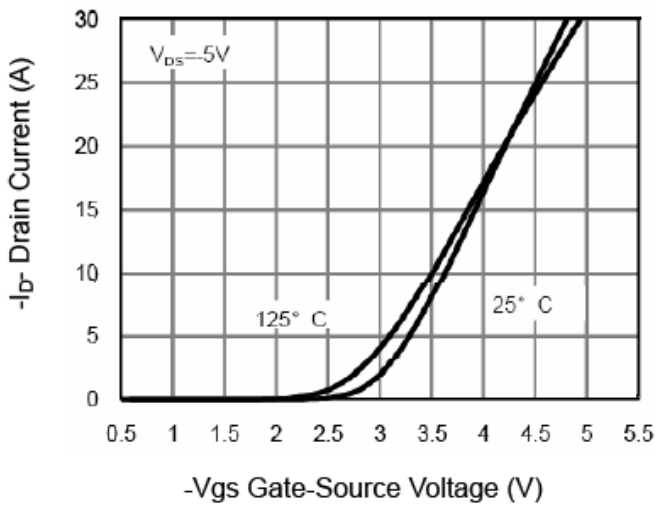

Figure 3 Transfer Characteristics

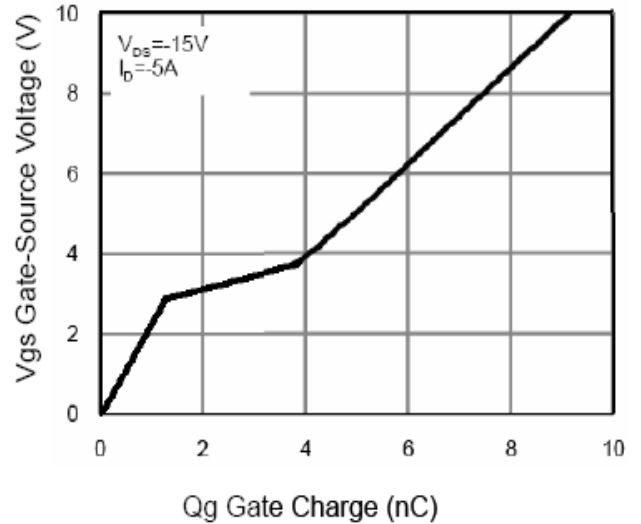

Figure 4 Gate Charge

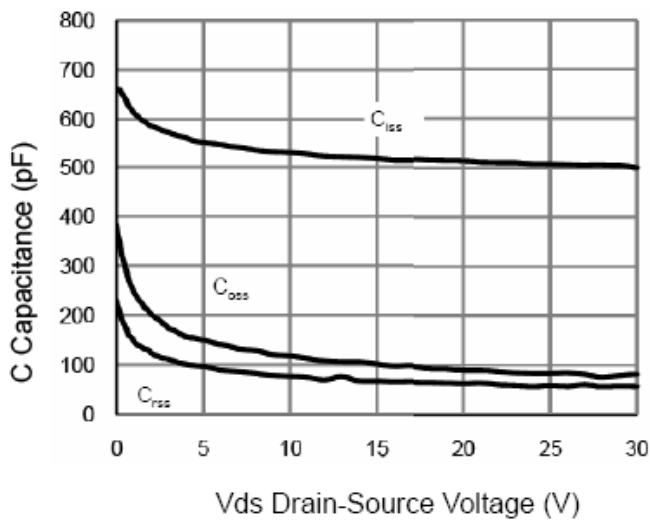

Figure 5 Capacitance vs V_{ds}

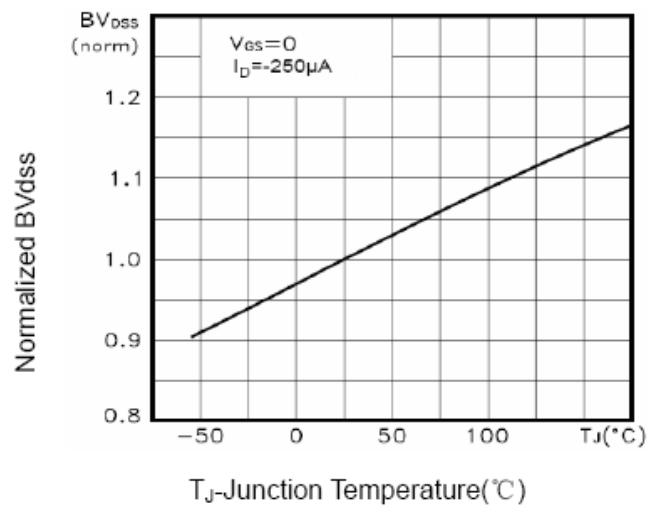

Figure 6 BV_{dss} vs Junction Temperature

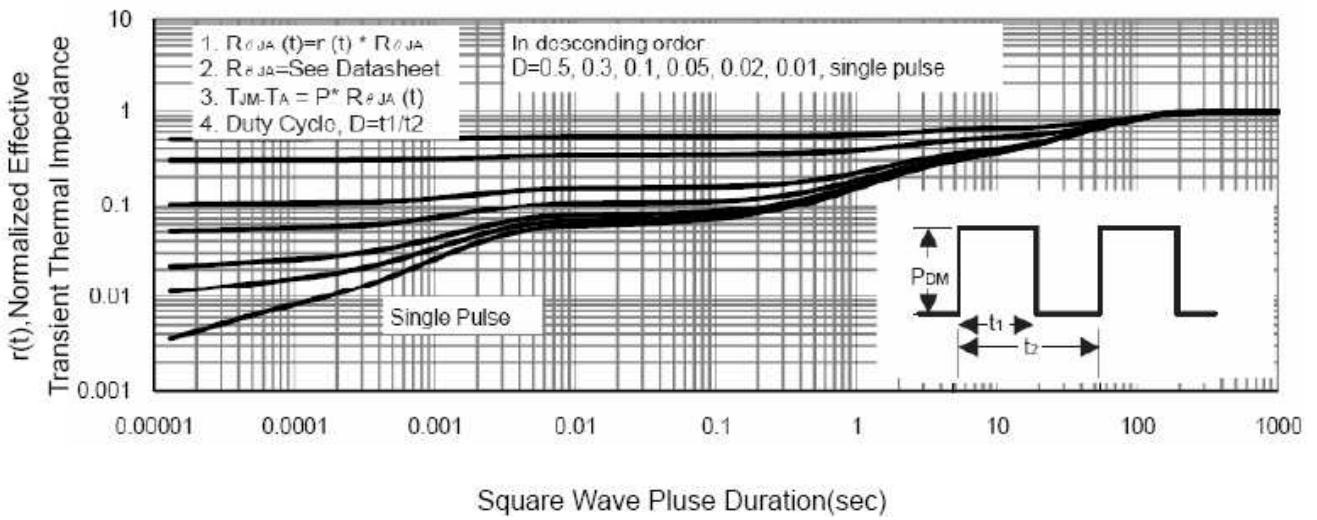

Figure 7 Normalized Maximum Transient Thermal Impedance