

MORNSUN®

URB1D_LD-15W & URB1D_LD-20W SERIES

**ULTRA WIDE INPUT, ISOLATED & REGULATED
SINGLE OUTPUT DC-DC CONVERTER**



Patent Protected RoHS **CE**

PART NUMBER SYSTEM

URB1D05LD-20W

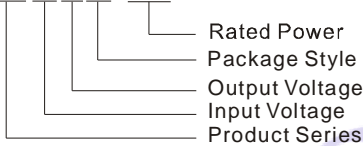

FEATURES

- Efficiency up to 89%
- 4:1 wide input voltage range
- 1.5KVDC isolation
- Operating temperature range: -40°C ~ +85°C
- Output over current protection, output over voltage protection, input under voltage protection and output short circuit protection(automatic recovery)
- Six-sided metal shield, Industry standard pinout
- Inverse polarity protection for A2S (chassis mounting) and A4S (DIN-Rail mounting)
- Meet EN60950

APPLICATION

URB1D_LD-15W & URB1D_LD-20W series Wide input voltage range is 40-160VDC. It is suitable for 72 V, 96 V, 110 V standard input of the bus voltage, single output and 1500VDC isolation, over current, over voltage and short-circuit protection. It offers good EMC performance, meet EN60950 standards. All models are particularly suited to railway etc.

SELECTION GUIDE

Approval	Model ①	Input Voltage(VDC)		Output Voltage (VDC)	Output Current (mA)		Input Current (mA)(typ.)		Reflected Ripple Current (mA,typ.)	Max. Capacitive Load (μF)	Efficiency® (% , typ.) @Max. Load
		Nominal (Range)	Max.②		Max.	Min.	@Max. Load	@No Load			
CE	URB1D03LD-15W	110 (40-160)	176	3.3	4000	200	120	15	25	4020	87
	URB1D05LD-15W			5	3000	150	153	15		4020	89
	URB1D12LD-15W			12	1250	63	155	8		1600	88
	URB1D15LD-15W			15	1000	50	155	8		1000	88
	URB1D24LD-15W			24	625	32	155	8		470	88
	URB1D05LD-20W			5	4000	200	204	15		4020	89
	URB1D12LD-20W			12	1667	83	206	8		1600	88
	URB1D15LD-20W			15	1333	67	206	8		1000	88
	URB1D24LD-20W			24	833	42	206	8	470	88	

Note: ①series with suffix "H" are heat sink mounting; series with suffix "A2S" are chassis mounting, with suffix "A4S" are DIN-Rail mounting, for exampleURB1D05LD-20WHA2S is chassis mounting of with heat sink,URB1D05LD-20WA4S is DIN-Rail mounting of without heat sink, if the application has a higher requirement for heat dissipation, you can choose modules with heat sink;

②Absolute maximum rating without damage on the converter;

③The efficiency of "A2S" and "A4S" is approx. 2% lower for the protection of inverse polarity.

INPUT SPECIFICATIONS

Item	Test Conditions	Min.	Typ.	Max.	Unit
Input Surge Voltage (1sec.max.)		-0.7	--	200	VDC
Start-up Voltage	100% load	--	--	39.8	

Under Voltage Shutdown	100% load	36.0	--	--	VDC
Start-up Time	Nominal input& constant resistance load	--	10	--	ms
Ctrl*	Models ON	Ctrl open or connect TTL high level (2.5-12VDC)			
	Models OFF	Ctrl connect GND or low level (0-1.2VDC)			
	Input current (Models OFF)	--	1	--	mA
Input Filter		Pi Filter			

Note: *The Ctrl pin voltage is referenced to GND.

OUTPUT SPECIFICATIONS

Item	Test Conditions	Min.	Typ.	Max.	Unit
Output Voltage Accuracy		--	±1	±3	%
Line Regulation	Full load, Input voltage from low to high	--	±0.2	±0.5	
Load Regulation	5% to 100% load	--	±0.5	±1	
Transient Recovery Time	25% load step change	--	500	800	us
Transient Response Deviation		--	±3	±5	%
Temperature Drift	Full load	--	±0.02	--	%/°C
Ripple & Noise *	20MHz bandwidth	50	75	100	mV
Output Voltage Range(Trim)		--	±10%Vo	--	VDC
Output Over Voltage Protection	3.3V output	--	4.1	--	
	5V output	--	6.2	--	
	12V output	--	15	--	
	15V output	--	18	--	
	24V output	--	28.8	--	
Over Current Protection	Full input voltage	110	130	170	%
Output Short Circuit Protection		Continuous, automatic recovery			

Note:* Ripple and noise tested with "parallel cable" method. See detailed operation instructions at DC-DC Application Notes .

COMMON SPECIFICATIONS

Item	Test Conditions	Min.	Typ.	Max.	Unit
Isolation Voltage	Tested for 1 minute , leakage current less than 1 mA	1500	--	--	VDC
Isolation Resistance	Test at 500VDC	1000	--	--	MΩ
Isolation Capacitance	Input/Output, 100KHz/0.1V	--	2000	--	pF
Switching Frequency	PWM mode	--	300	--	KHz
MTBF	MIL-HDBK-217F@25°C	1000	--	--	K hours
Safety approvals		EN60950			
Case Material		Aluminum Alloy			
Size	PCB mounting (Without heat sink)	50.80×25.40×11.80			mm
	PCB mounting (With heat sink)	50.80×25.40×16.30			
	A2S Chassis mounting (Without heat sink)	76.00×31.50×21.20			
	A2S Chassis mounting (With heat sink)	76.00×31.50×25.10			
	A4S DIN-Rail mounting (Without heat sink)	76.00×31.50×25.80			
	A4S DIN-Rail mounting (With heat sink)	76.00×31.50×29.70			
Weight	PCB mounting (Without heat sink)	--	28	--	g
	PCB mounting (With heat sink)	--	36	--	
	A2S Chassis mounting (Without heat sink)	--	50	--	
	A2S Chassis mounting (With heat sink)	--	58	--	
	A4S DIN-Rail mounting (Without heat sink)	--	70	--	
	A4S DIN-Rail mounting (With heat sink)	--	78	--	

ENVIRONMENTAL SPECIFICATIONS

Item	Test Conditions	Min.	Typ.	Max.	Unit
Storage Humidity	Non condensing	5	--	95	%
Operating Temperature	See Temperature Derating Curve (Figure 3)	-40	--	85	°C
Storage Temperature		-55	--	125	

The Max. Case Temperature	Operating Temperature curve range	--	--	105	°C
Lead Temperature	1.5mm from case for 10 seconds	--	--	300	
Cooling		Free air convection			

RAILWAY CONVERTER PROPRIETARY SPECIFICATIONS

Transient Input Voltage	RIA12	385V / 20ms perf. Criteria A (Pulse Interval > 60s) (With MORNSUN's FC-CX1D Module, Refer to Figure 1)
Maximum Input Voltage	EN50155	1800V(5/50us, 5Ωor100Ω) perf. Criteria B (Pulse Interval > 60s) (With MORNSUN's FC-CX1D Module, Refer to Figure 1)
	EN50155	8400V(0.05/0.1μs, 100Ω) perf. Criteria B (Pulse Interval > 60s) (With MORNSUN's FC-CX1D Module, Refer to Figure 1)

EMC SPECIFICATIONS

EMI	CE	CLASS B(With MORNSUN's FC-CX1D Module, Refer to Figure 1)	
	RE	CLASS B(With MORNSUN's FC-CX1D Module, Refer to Figure 1)	
EMS	ESD	IEC/EN61000-4-2 Contact ±6KV	perf. Criteria B
	RS	IEC/EN61000-4-3 10V/m	perf. Criteria A
	EFT	IEC/EN61000-4-4 ±4KV (With MORNSUN's FC-CX1D Module, Refer to Figure 1)	perf. Criteria B
	Surge	IEC/EN61000-4-5 ±2KV/±4KV (With MORNSUN's FC-CX1D Module, Refer to Figure 1)	perf. Criteria B
	CS	IEC/EN61000-4-6 3 Vr.m.s	perf. Criteria A
	Voltage dips, short and interruptions immunity	IEC/EN61000-4-29 0%-70%	perf. Criteria B

EMC MODULE APPLICATION CIRCUIT

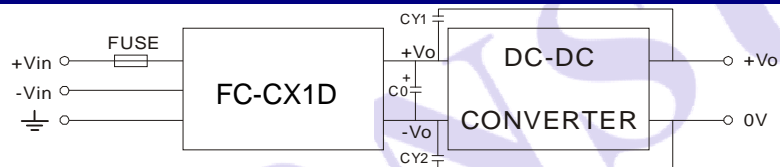

FC-CX1D's input voltage range:40V-160V
(Figure 1)

FUSE: Choose according to customer actual input current.

C0: Recommend to use 100uF/200V electrolytic capacitor; It is used to suppress voltage dips, is not designed without requirement of the application.

CY1/CY2:1nF/2KV.

EMC MODULE RECOMMENDED CIRCUIT PCB LAYOUT

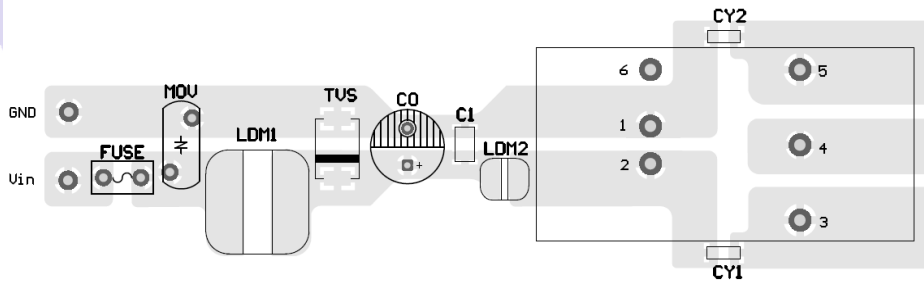

(Figure 2)

Note:PCB layout carry out according to the module application circuit ,refer to Figure 2,need to add capacitance C0 and change the URB1D_LD-15W & URB1D_LD-20W pin package.

EMI TEST WAVEFORM (CLASS B APPLY CIRCUIT)

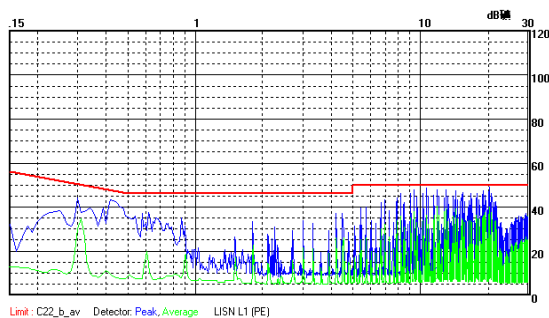

URB1D05LD-15W CE (Positive line)

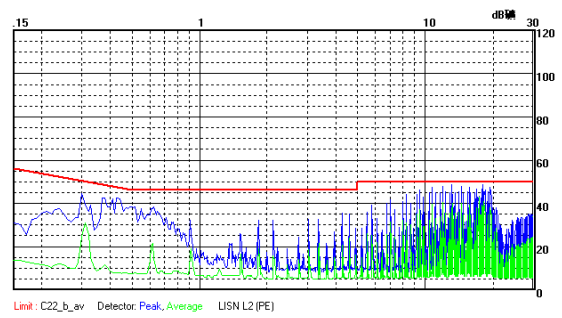

URB1D05LD-15W CE (Negative line)

The copyright and authority for the interpretation of the products are reserved by MORNSUN

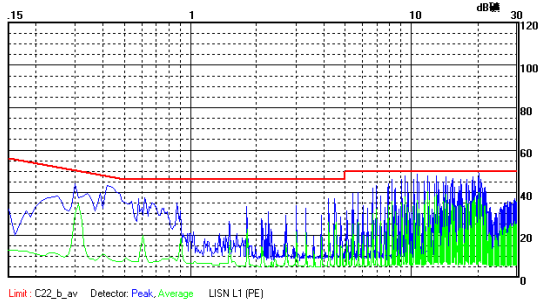

URB1D05LD-20W CE (Positive line)

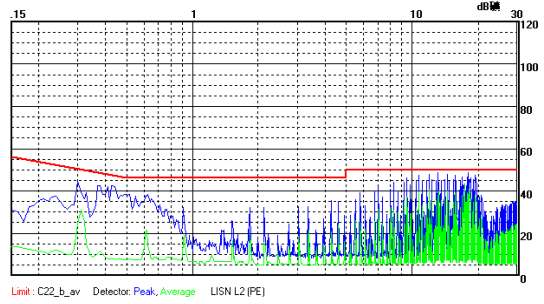

URB1D05LD-20W CE (Negative line)

PRODUCT TYPICAL CURVE

Temperature Derating Graph

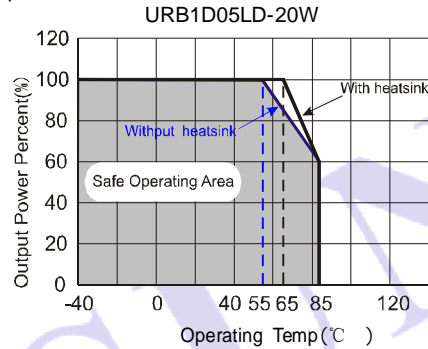
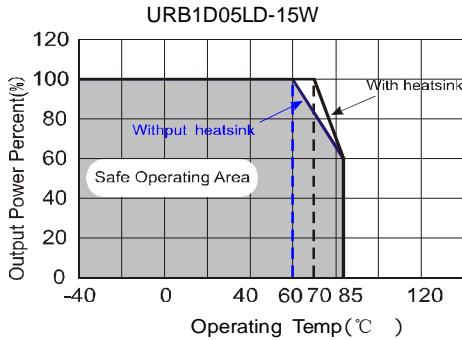

(Figure 3)

Efficiency VS Input Voltage curve (Full Load)

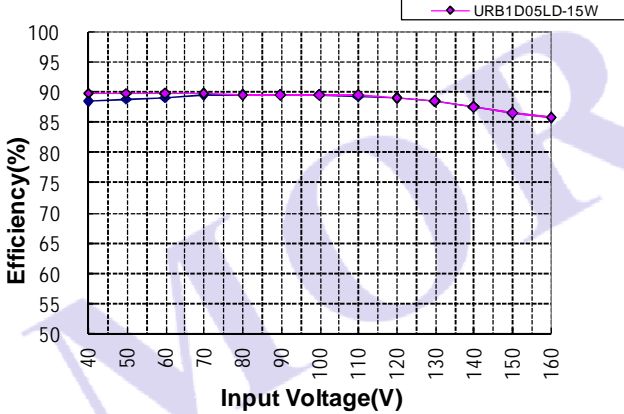

Efficiency VS Output Load curve (Vin=Vin-nominal)

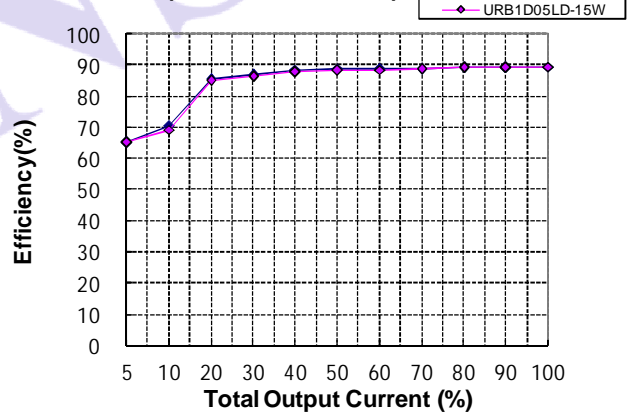

Efficiency VS Input Voltage curve (Full Load)

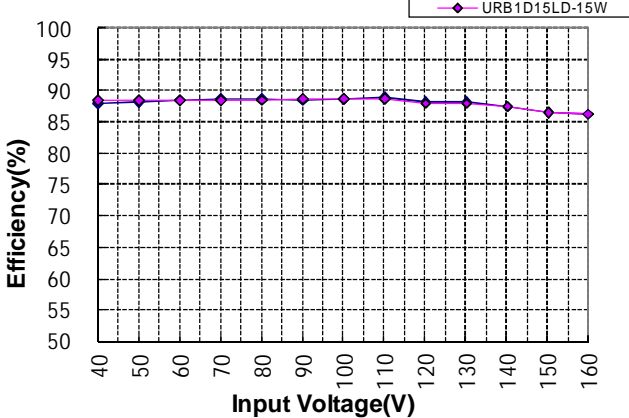

Efficiency VS Output Load curve (Vin=Vin-nominal)

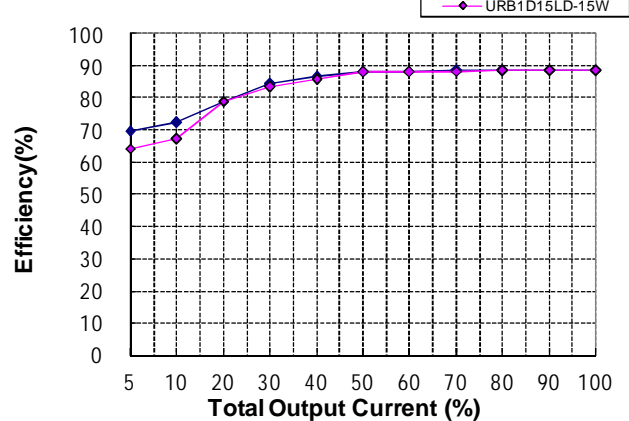

PCB MOUNTING (WITHOUT HEATSINK) OUTLINE DIMENSIONS, RECOMMENDED FOOTPRINT

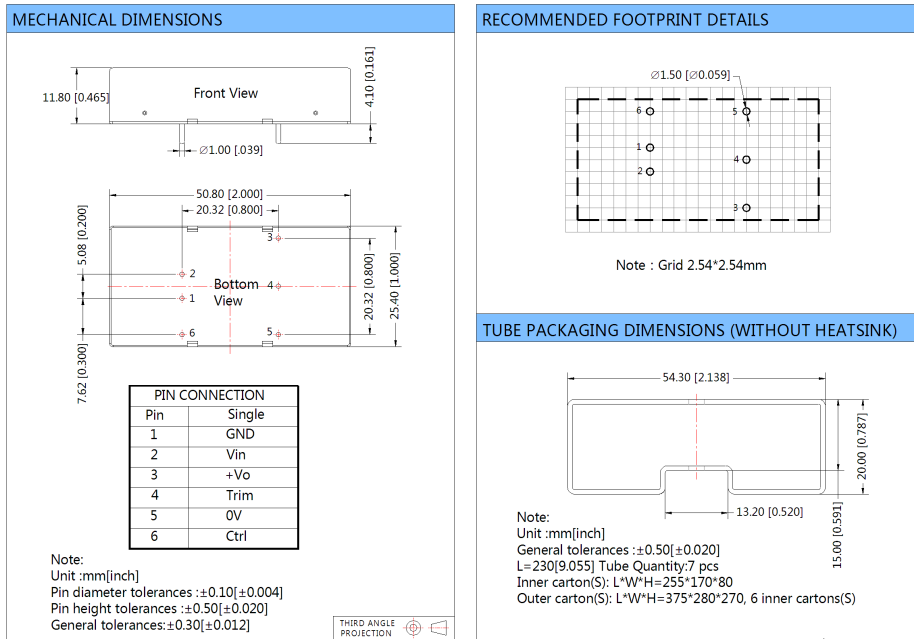

PCB MOUNTING (WITH HEATSINK) OUTLINE DIMENSIONS

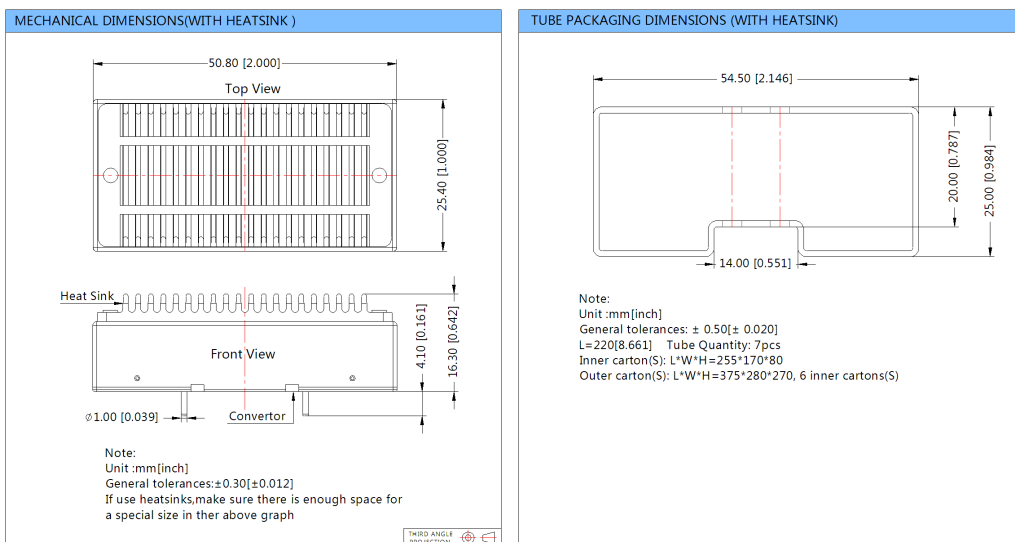

URB1D_LD-15WA2S & URB1D_LD-20WA2S SCHASSIS MOUNTING OUTLINE DIMENSIONS



Footprint Details:

Pin	1	2	3	4	5	6
Function	Ctrl	GND	Vin	0V	Trim	+Vo

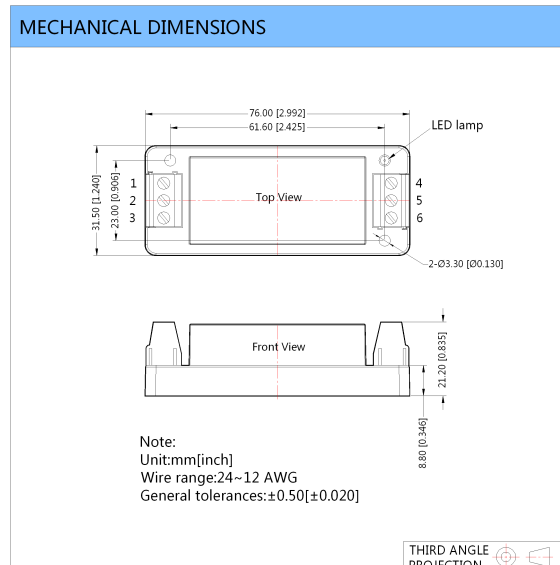

URB1D_LD-15WHA2S & URB1D_LD-20WHA2S CHASSIS MOUNTING OUTLINE DIMENSIONS



Footprint Details

Pin	1	2	3	4	5	6
Function	Ctrl	GND	in	0V	Trim	+Vo

MECHANICAL DIMENSIONS(WITH HEATSINK)

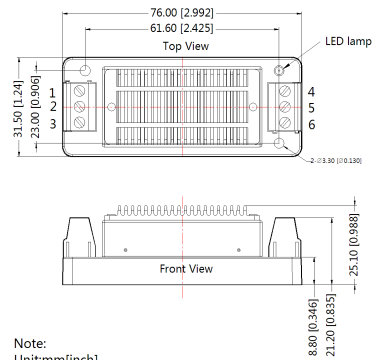

Note:
Unit:mm[inch]
Wire range:24~12 AWG
General tolerances:±0.50[±0.020]

THIRD ANGLE PROJECTION

URB1D_LD-15WA4S & URB1D_LD-20WA4S DIN-RAIL MOUNTING OUTLINE DIMENSIONS



DIN-rail modules are fitting to TS35 rails

Footprint Details:

Pin	1	2	3	4	5	6
Function	Ctrl	GND	Vin	0V	Trim	+Vo

MECHANICAL DIMENSIONS

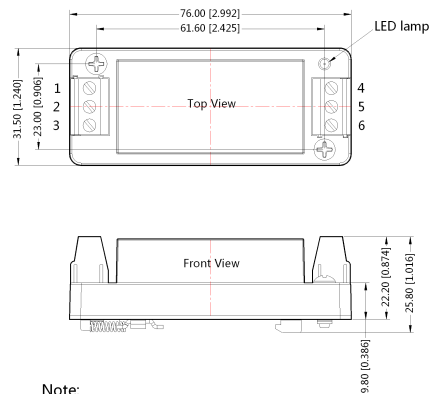

Note:
Unit:mm[inch]
Wire range : 24~12 AWG
General tolerances:±0.50[±0.020]

THIRD ANGLE PROJECTION

URB1D_LD-15WHA4S & URB1D_LD-20WHA4S DIN-RAIL MOUNTING OUTLINE DIMENSIONS

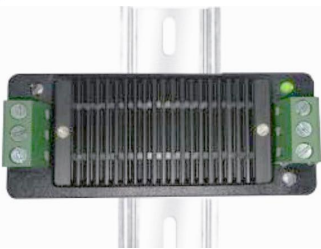

DIN-rail modules are fitting to TS35 rails

Footprint Details

Pin	1	2	3	4	5	6
Function	Ctrl	GND	Vin	0V	Trim	+Vo

MECHANICAL DIMENSIONS(WITH HEATSINK)

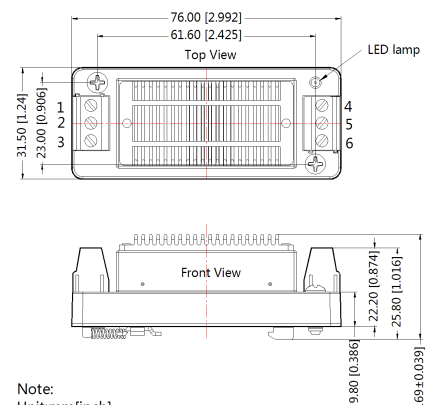

Note:
Unit:mm[inch]
Wire range:24~12 AWG
General tolerances:±0.50[±0.020]

THIRD ANGLE PROJECTION

PACKAGE DIAGRAM

Special Package Series (A2S/A4S)

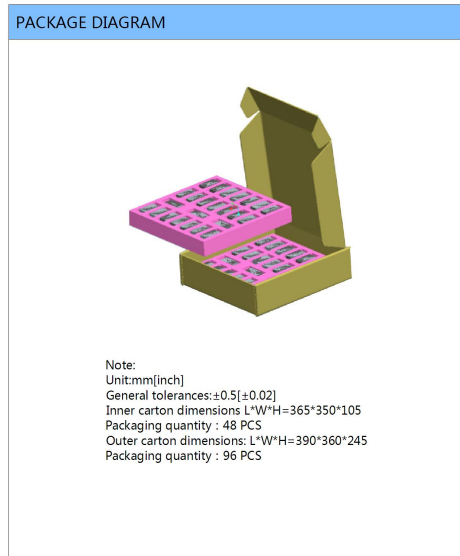

TEST CONFIGURATIONS

Input Reflected-Ripple Current Test Setup

Input reflected-ripple current is measured with an inductor L_{in} and Capacitor C_{in} to simulate source impedance.

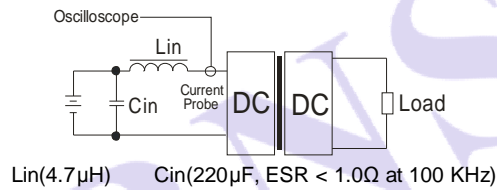

TRIM APPLICATION & TRIM RESISTANCE

Application circuit for TRIM (Part in broken line is the interior of models)

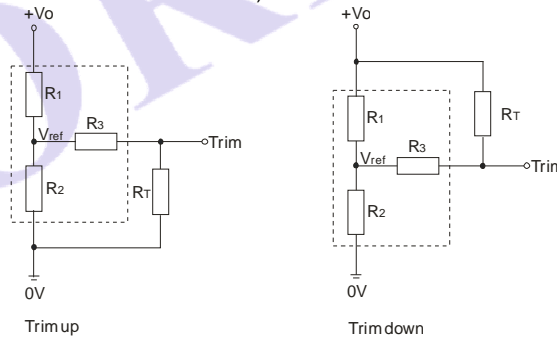

Formula for resistance of Trim

$$\begin{aligned} \text{up: } R_T &= \frac{aR_2}{R_2-a} - R_3 & a &= \frac{V_{ref}}{V_o' - V_{ref}} \cdot R_1 \\ \text{down: } R_T &= \frac{aR_1}{R_1-a} - R_3 & a &= \frac{V_o' - V_{ref}}{V_{ref}} \cdot R_2 \end{aligned}$$

Note: Trim Hung up when not in use;

Value for R_1 , R_2 , R_3 , and V_{ref} refer to the above (Table 1)

R_T : Resistance of Trim,

a : User-defined parameter, no actual meanings

V_o' : The trim up/down voltage.

(Table 1)

V_o	3.3(VDC)	5(VDC)	12(VDC)	15(VDC)	24(VDC)
Parameter					
$R_1(K\Omega)$	4.801	2.883	10.971	14.497	24.872
$R_2(K\Omega)$	2.864	2.864	2.864	2.864	2.863
$R_3(K\Omega)$	15	10	17.8	17.8	17.8
$V_{ref}(V)$	1.24	2.5	2.5	2.5	2.5

DESIGN CONSIDERATIONS

1) Recommended circuit

All the URB1D_LD-15W &URB1D_LD-20W Series have been tested according to the following recommended testing circuit before leaving fact (see Figure 4).

If you want to further decrease the input/output ripple, you can increase a capacitance properly or choose capacitors with low ESR, but the greatest capacitance of its filter capacitor must less than the Max. Capacitive Load. The recommended capacitance of its filter capacitor sees (Table 2).

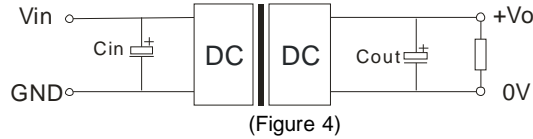

EXTERNAL CAPACITOR TABLE (Table 2)

Output Voltage	Capacitance Cout (μF)	Cin(μF)
3.3V/5V	470	100
12/15V	220	
24V	100	

2) It is not recommended to increase the output power capability by connecting two or more converters in parallel. The product is not hot-swappable

Note:

1. Min. load shouldn't be less than 5%, otherwise ripple maybe increased dramatically, If the product operates under min. load, it may not be guaranteed to meet all specifications listed. Operation under minimum load will not damage the converter.
2. Max. Capacitive Load is tested at input voltage range and full load.
3. All specifications measured at Ta=25°C, humidity<75%, nominal input voltage and rated output load unless otherwise specified.
4. In this datasheet, all test methods are based on our corporate standards.
5. All characteristics are for listed models, and non-standard models may perform differently. Please contact our technical support for more details.
6. Please contact our technical support for any specific requirement.
7. Specifications of this product are subject to changes without prior notice.

MORNSUN Science & Technology Co.,Ltd.

Address: No. 5, Kehui St. 1, Kehui development center, Science Ave., Guangzhou Science City, Luogang district, Guangzhou, P.R.China.

Tel: 86-20-38601850

Fax: 86-20-38601272

E-mail: info@mornsun.cn

[Http://www.mornsun-power.com](http://www.mornsun-power.com)