

Features

- Wide Input Voltage Range: 8V ~ 30V
- Up to 93% Efficiency
- No Loop Compensation Required
- Dual-channeling CC/CV control
- Cable drop Compensation from 0Ω to 0.3Ω
- Programmable CC Current
- Thermal Shutdown
- Over current protection
- ULVO protection
- Available in SOP8L Package

Applications

- Car Charger / Adaptor
- LED Driver
- Pre-Regulator for Linear Regulators
- Distributed Power Systems
- Battery Charger

Description

The HX1336 is a wide input range step down DC/DC converter from a high voltage input supply. Operating with an input voltage range of 8V ~ 30V, the HX1336 achieves 2A continuous output current with excellent load and line regulation. The synchronous architecture provides for highly efficient designs. Constant current and constant voltage mode operation provide fast transient response and ease loop stabilization.

The HX1336 features a dual-channeling CV/CC mode control functions. It operates in the Constant output current mode or Constant output Voltage mode. The over current protection current value is set by current sensing resistors.

The HX1336 requires a minimum number of readily available standard external components. Other features include cable drop compensation, and thermal shutdown.

The HX1336 converter is available in the industry standard SOP8L packages.

Typical Application Circuit

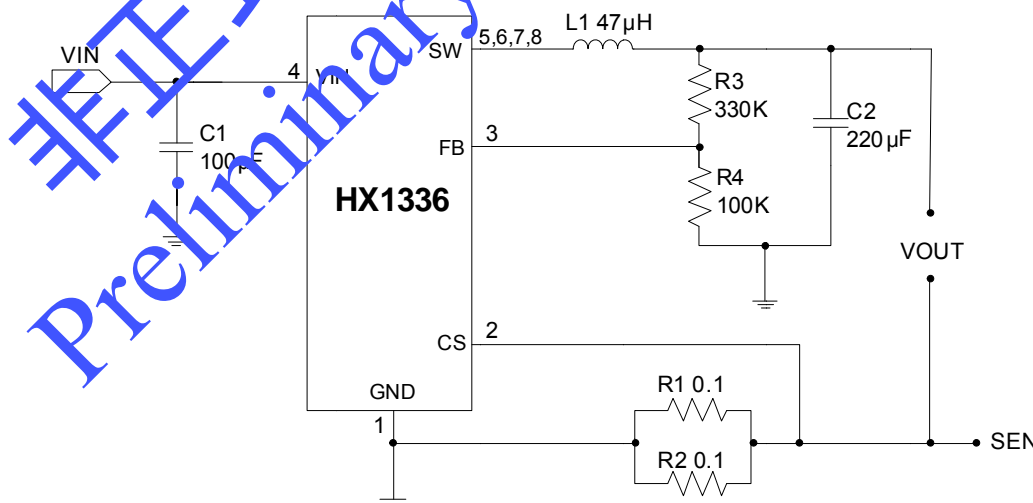

*The output voltage is set by R3 and R4: $V_{OUT} = 1.21V \cdot [1 + (R3/R4)]$.

*The output current of VOUT is set by $I_{CS} = 100\text{mv} / \{R1 \times R2 / (R1 + R2)\}$

Pin Assignment and Description

TOP VIEW	PIN	NAME	DESCRIPTION
 <p style="text-align: center;">SOP-8L</p>	1	GND	Ground
	2	CS	Current Sense Input
	3	FB	Feedback
	4	VIN	Input Supply Voltage
	5,6,7,8	SW	Switch Node

Absolute Maximum Ratings (Note 1)

- Input Supply Voltage -0.3V ~ 35V
- FB Voltages..... -0.3V ~ 6V
- SW Voltage -0.3V ~ (VIN + 1V)
- Operating Temperature Range(Note 2).....-40°C ~ +85°C
- Junction Temperature.....+150°C
- Storage Temperature Range..... - 65°C ~ +150°C
- Lead Temperature (Soldering 10 sec)..... +265°C

Note 1: Absolute Maximum Ratings are those values beyond which the life of a device may be impaired.

Note 2: The HX1336 is guaranteed to meet performance specifications from 0°C to 70°C. Specifications over the -40°C to 85°C operating temperature range are assured by design, characterization and correlation with statistical process controls.

非正式版本 仅限内部使用
Preliminary for Internal use only

Pin Functions

GND (Pin 1): Ground Pin.

CS (Pin 2): Current or voltage sense pin of VOUT. If SEN is larger than the sense voltage, the HX1336 will shut down for protection. The output current is programmed by connecting resistors, R1, R2.

The output current is set: $I_{CS} = 100\text{mv} / \{R1 \times R2 / (R1 + R2)\}$

FB (Pin 3): Feedback Pin. Receive the feedback voltage from an external resistive divider across the output. The output voltage is set by R3 and R4: $V_{OUT} = 1.21\text{V} \cdot [1 + (R3 / R4)]$.

VIN (Pin 4): Main power supply Pin.

SW (Pin 5, 6, 7, 8): Switch Node.

Block Diagram

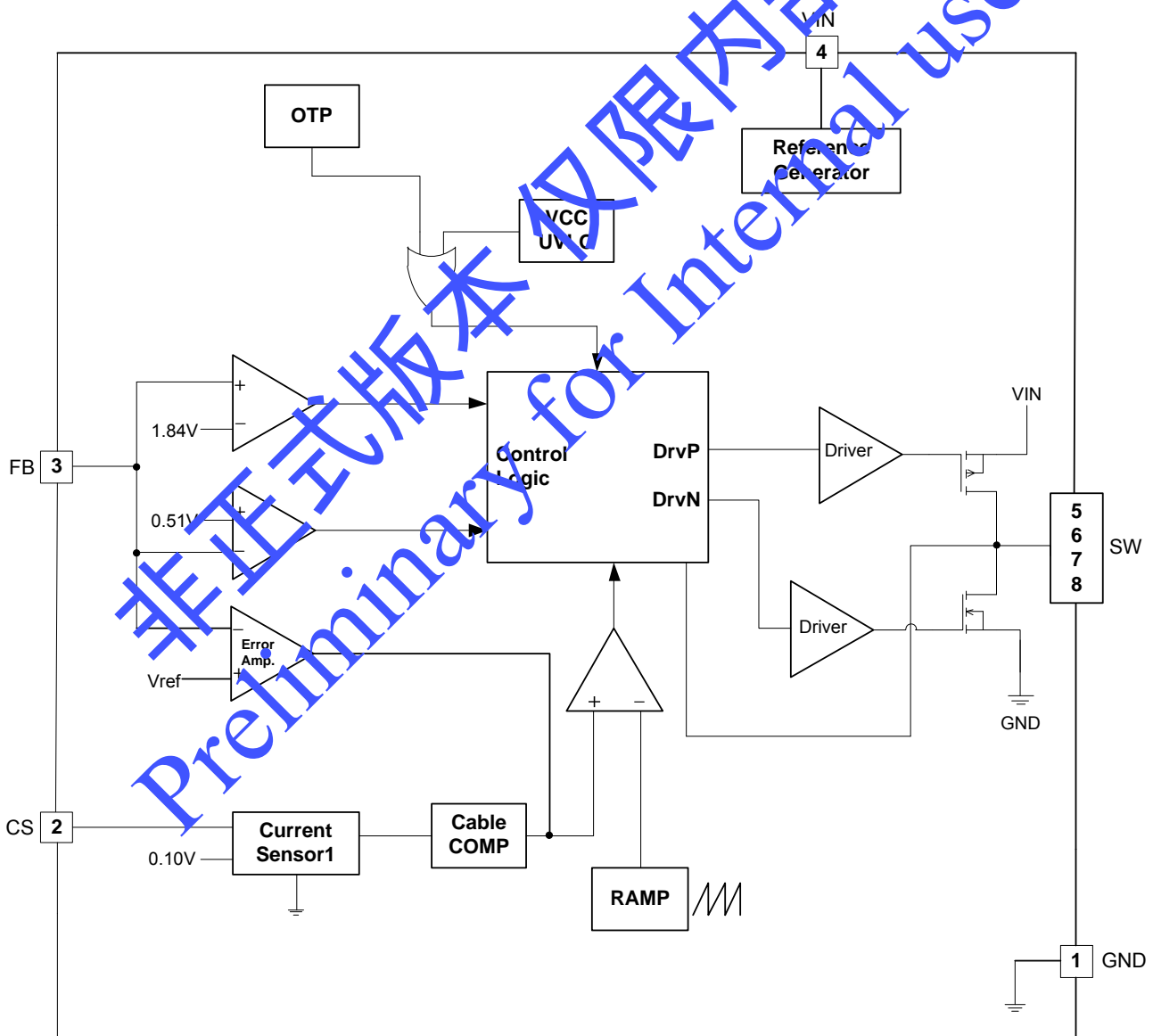

Electrical Characteristics

 Operating Conditions: $T_A=25^{\circ}\text{C}$, $V_{IN} = 12\text{V}$, $R_3 = 330\text{K}$, $R_4 = 100\text{K}$, unless otherwise specified.

SYMBOL	PARAMETER	CONDITIONS	MIN	TYP	MAX	UNITS
V_{IN}	Operating Voltage Range		8		30	V
I_Q	Quiescent Current	$V_{IN} = 12\text{V}$		1.3		mA
I_{OFF}	Shutdown Current			112		μA
V_{UVLO}	Input UVLO Threshold			4.1		V
ΔV_{UVLO}	UVLO Hysteresis			200		mV
V_{OVLO}	OVLO Threshold			34		V
ΔV_{OVLO}	OVLO Hysteresis			2.5		V
V_{FB}	Regulated Voltage			1.212		V
ΔV_{FB}	Regulated Voltage Tolerance		-2		+2	%
I_{FB}	Feedback Pin Input Current				0.05	μA
V_{CS}	Reference Voltage Of Current Sense Pin		90	100	115	mV
f_{OSC}	Oscillator Frequency Range		100	130	150	kHz
DC	Max Duty Cycle			100		%
ΔV_{OUT}	Output Cable Resistance Compensation	$R_1=R_2=100\text{m}\Omega$, $I_{OUT}=1\text{A}$, $R_3=660\text{k}\Omega$		0.8		V
T_{SD}	Thermal Shutdown			125		$^{\circ}\text{C}$
T_{RSD}	Thermal Shutdown Recovery			100		$^{\circ}\text{C}$

Typical Performance Characteristics

Operating Conditions: $T_A=25^{\circ}\text{C}$, unless otherwise specified.

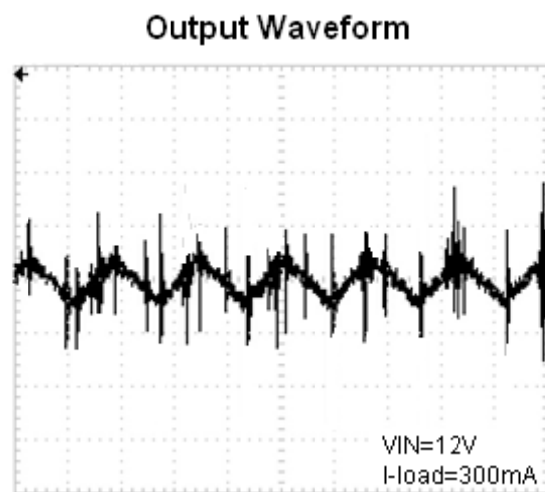
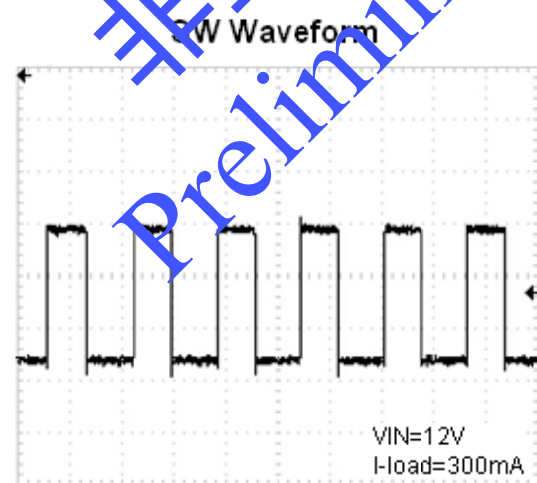
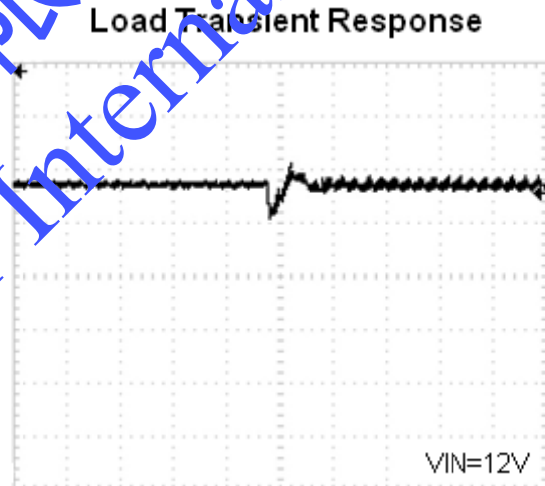
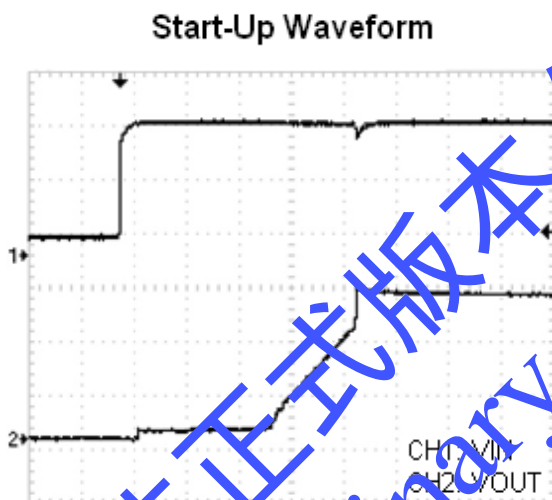
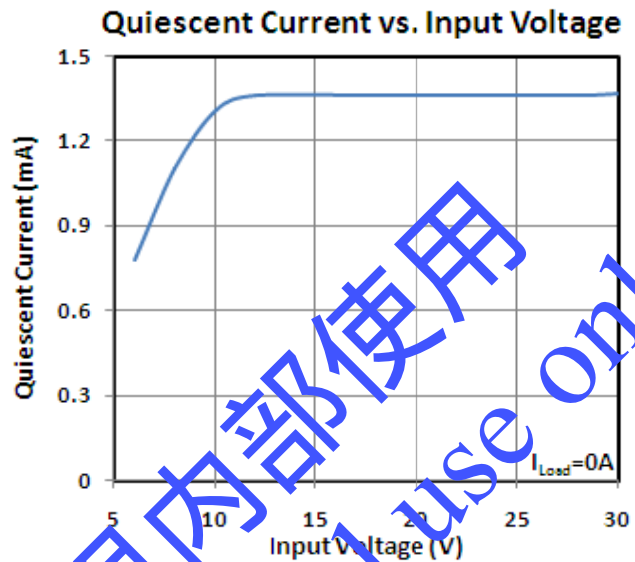
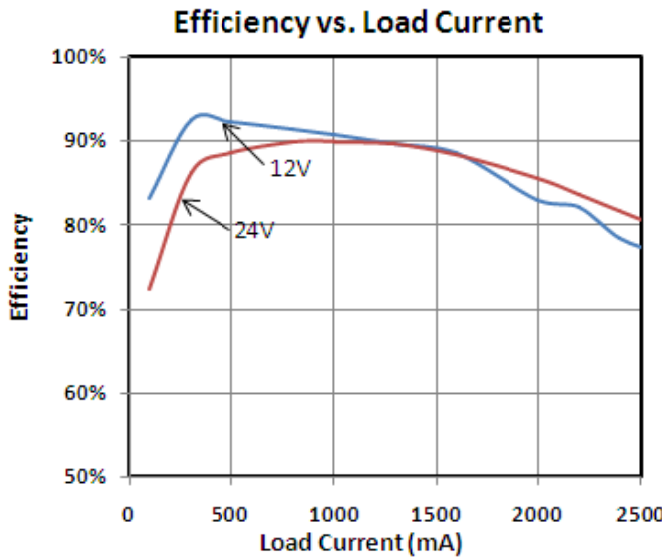

Application Information

The HX1336 operates by a constant frequency, current mode architecture. The output voltage is set by an external divider returned to the FB pin. An error amplifier compares the divided output voltage with a reference voltage of 1.21V and adjusts the peak inductor current accordingly.

Dual-channeling CV/CC mode control

HX1336 provides the function of dual-channeling CV/CC mode control. The constant output current control mode and constant output voltage control mode. CS pins are connected to the current sensing resistors to prevent the condition of output short circuit and output over current.

Thermal Protection

The total power dissipation in HX1336 is limited by a thermal protection circuit. When the device temperature rises to approximately +125°C, this circuit turns off the output, allowing the IC to cool. The thermal protection circuit can protect the device from being damaged by overheating in the event of fault conditions. Continuously running the HX1336 into thermal shutdown degrades device reliability.

Output Cable Resistance Compensation

To compensate for resistive voltage drop across the charger's output cable, the HX1336 integrates a simple, user-programmable cable voltage drop compensation using the impedance at the FB pin. Choose the proper feedback resistance values for cable compensation refer to the curve. The delta V_{OUT} voltage rises when the feedback resistance R3 value rises. The delta V_{OUT} voltage rises when the feedback resistance R4 value rises. Use the equation below.

$$V_{OUT} = \left(1 + \frac{R3}{R4}\right) \times V_{FB} + R3 \times \frac{V_{Rsense}}{100mV} \times 2.5\mu A$$

Output Cable Resistance Compensation

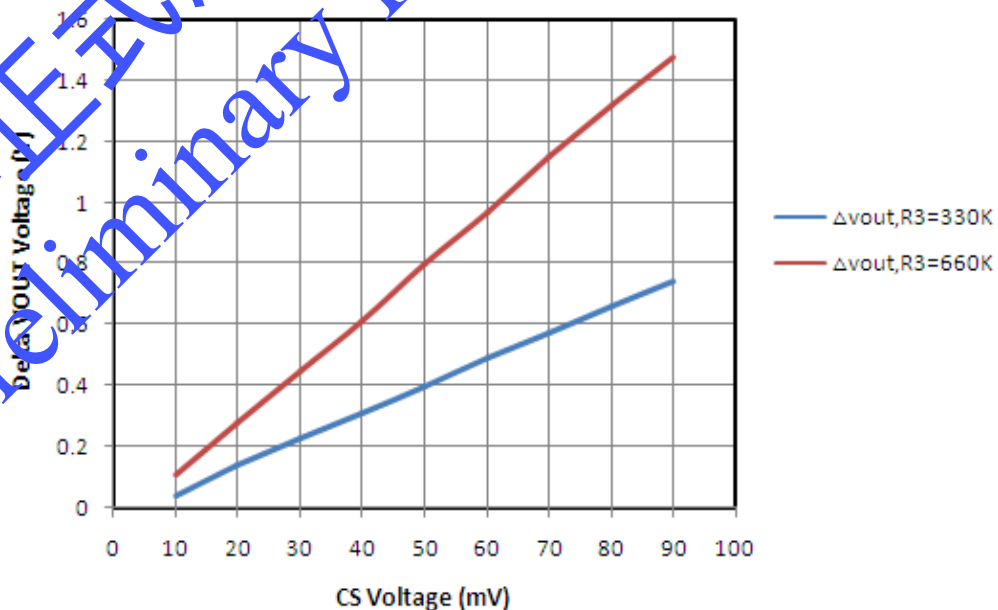

*From figure above, if $R_{cs}=50m\Omega$, $I_{OUT}=1A$, $R3=660k\Omega$, $V_{cs}= R_{cs} \times I_{OUT}=50mV$, then $\Delta V_{OUT}=0.8V$.

Setting Output Voltage

The output voltage is set with a resistor divider from the output node to the FB pin. It is recommended to use divider resistors with 1% tolerance or better. To improve efficiency at very light loads consider using larger value resistors. If the values are too high the regulator is more susceptible to noise and voltage errors from the FB input current are noticeable. For most applications, a resistor in the 10kΩ to 1MΩ range is suggested for R4. R3 is then given by:

$$R3 = R4 \cdot [(V_{OUT} / V_{REF}) - 1]$$

where V_{REF} is 1.21V.

Inductor Selection

For most applications, the value of the inductor will fall in the range of 4.7μH to 47μH. Its value is chosen based on the desired ripple current. Large value inductors lower ripple current and small value inductors result in higher ripple currents. Higher V_{IN} or V_{OUT} also increases the ripple current as shown in equation. A reasonable starting point for setting ripple current is $\Delta I_L = 800mA$ (40% of 2A).

$$\Delta I_L = \frac{1}{(f)(L)} V_{OUT} \left(1 - \frac{V_{OUT}}{V_{IN}} \right)$$

The DC current rating of the inductor should be at least equal to the maximum load current plus half the ripple current to prevent core saturation. Thus, a 2.8A rated inductor should be enough for most applications (2A + 800mA). For better efficiency, choose a low DC-resistance inductor.

Different core materials and shapes will change the size/current and price/current relationship of an inductor. Toroid or shielded pot cores in ferrite or perm alloy materials are small and don't radiate much energy, but generally cost more than powdered iron core inductors with similar electrical characteristics. The choice of which style inductor to use often depends more on the price vs. size requirements and any radiated field/EMI requirements than on what the HX1336 requires to operate.

Output and Input Capacitor Selection

In continuous mode, the source current of the top MOSFET is a square wave of duty cycle V_{OUT}/V_{IN} . To prevent large voltage transients, a low ESR input capacitor sized for the maximum RMS current must be used. The maximum RMS capacitor current is given by:

$$C_{IN} \text{ required } I_{RMS} \approx I_{OMAX} \frac{[V_{OUT}(V_{IN} - V_{OUT})]^{1/2}}{V_{IN}}$$

This formula has a maximum at $V_{IN} = 2V_{OUT}$, where $I_{RMS} = I_{OUT}/2$. This simple worst-case condition is commonly used for design because even significant deviations do not offer much relief. Note that the capacitor manufacturer's ripple current ratings are often based on 2000 hours of life. This makes it advisable to further derate the capacitor, or choose a capacitor rated at a higher temperature than required. Always consult the manufacturer if there is any question.

The selection of C_{OUT} is driven by the required effective series resistance (ESR). Typically, once the ESR requirement for C_{OUT} has been met, the RMS current rating generally far exceeds the $I_{RIPPLE(P-P)}$ requirement. The output ripple ΔV_{OUT} is determined by:

$$\Delta V_{OUT} \cong \Delta I_L \left(ESR + \frac{1}{8fC_{OUT}} \right)$$

Where f = operating frequency, C_{OUT} = output capacitance and ΔI_L = ripple current in the inductor. For a fixed output voltage, the output ripple is highest at maximum input voltage since ΔI_L increases with input voltage.

Aluminum electrolytic and dry tantalum capacitors are both available in surface mount configurations. In the case of tantalum, it is critical that the capacitors are surge tested for use in switching power supplies. An excellent choice is the AVX TPS series of surface mount tantalum. These are specially constructed and tested for low ESR so they give the lowest ESR for a given volume.

Efficiency Considerations

The efficiency of a switching regulator is equal to the output power divided by the input power times 100%. It is often useful to analyze individual losses to determine what is limiting the efficiency and which change would produce the most improvement. Efficiency can be expressed as: Efficiency = 100% - (L1+ L2+ L3+ ...) where L1, L2, etc. are the individual losses as a percentage of input power. Although all dissipative elements in the circuit produce losses, two main sources usually account for most of the losses: V_{IN} quiescent current and I^2R losses. The V_{IN} quiescent current loss dominates the efficiency loss at very low load currents whereas the I^2R loss dominates the efficiency loss at medium to high load currents. In a typical efficiency plot, the efficiency curve at very low load currents can be misleading since the actual power lost is of no consequence.

1. The V_{IN} quiescent current is due to two components: the DC bias current as given in the electrical characteristics and the internal main switch and synchronous switch gate charge currents. The gate charge current results from switching the gate capacitance of the internal power MOSFET switches. Each time the gate is switched from high to low to high again, a packet of charge ΔQ moves from V_{IN} to ground. The resulting $\Delta Q/\Delta t$ is the current out of V_{IN} that is typically larger than the DC bias current. In continuous mode, $I_{GATECHG} = f(Q_T + Q_B)$ where Q_T and Q_B are the gate charges of the internal top and bottom switches. Both the DC bias and gate charge losses are proportional to V_{IN} and thus their effects will be more pronounced at higher supply voltages.

2. I^2R losses are calculated from the resistances of the internal switches, R_{SW} and external inductor R_L . In continuous mode the average output current flowing through inductor L is "chopped" between the main switch and the synchronous switch. Thus, the series resistance looking into the SW pin is a

function of both top and bottom MOSFET $R_{DS(ON)}$ and the duty cycle (DC) as follows: $R_{SW} = R_{DS(ON)TOP} \times DC + R_{DS(ON)BOT} \times (1-DC)$ The $R_{DS(ON)}$ for both the top and bottom MOSFETs can be obtained from the Typical Performance Characteristics curves. Thus, to obtain I^2R losses, simply add R_{SW} to R_L and multiply the result by the square of the average output current. Other losses including C_{IN} and C_{OUT} ESR dissipative losses and inductor core losses generally account for less than 2% of the total loss.

Board Layout Suggestions

When laying out the printed circuit board, the following checklist should be used to ensure proper operation of the HX1336. Check the following in your layout.

1. The power traces, consisting of the GND trace, the SW trace and the VIN trace should be kept short, direct and wide.
2. Put the input capacitor as close as possible to the device pins (VIN and GND).
3. SW node is with high frequency voltage swing and should be kept small area. Keep analog components away from SW node to prevent stray capacitive noise pick-up.
4. Connect all analog grounds to a common node and then connect the common node to the power ground behind the output capacitors.

非正式版本 仅限内部使用
Preliminary for Internal use only

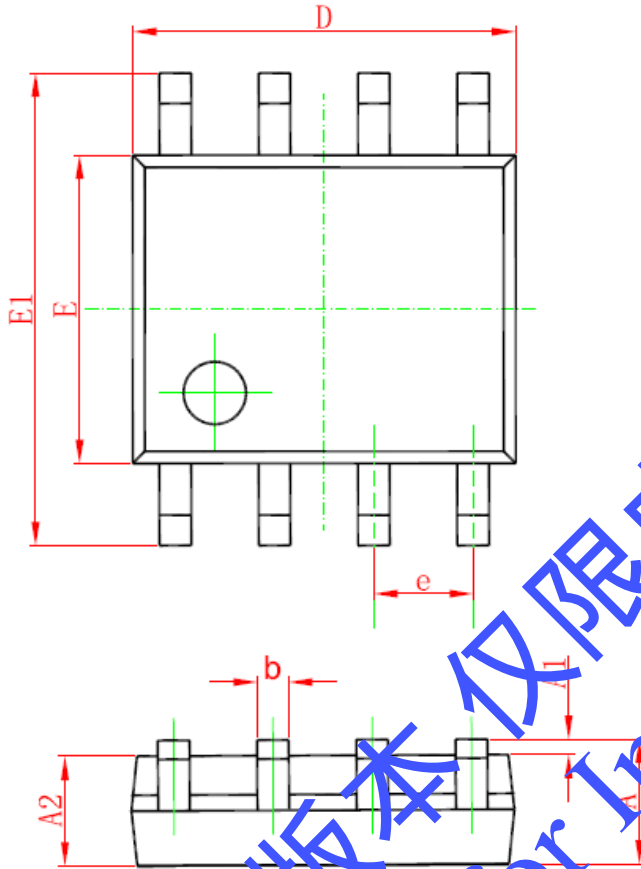
Packaging Information
SOP-8L Package Outline Dimension

Symbol	Dimensions In Millimeters		Dimensions In Inches	
	Min	Max	Min	Max
A	1.350	1.750	0.053	0.069
A1	0.100	0.250	0.004	0.010
A2	1.350	1.550	0.053	0.061
b	0.330	0.510	0.013	0.020
c	0.170	0.250	0.006	0.010
D	4.700	5.100	0.185	0.200
E	3.800	4.000	0.150	0.157
E1	5.800	6.200	0.228	0.244
e	1.270(BSC)		0.050(BSC)	
L	0.400	1.270	0.016	0.050
θ	0°	8°	0°	8°

Subject changes without notice.