



1. Scope:

- 1.1 This specification is covered following products:
 - 1.1.1 LR1206 series.
 - 1.1.2 LR2010 series.
 - 1.1.3 LR2512 series.
 - 1.1.4 LR2725 series.
 - 1.1.5 LR2728 series.

2. Product Features:

- 2.1 Ideal for all types of current sensing, voltage division and pulse applications including switching and linear power supplies, Instruments, power amplifiers.
- 2.2 Proprietary processing technique produces extremely low Resistance values.
- 2.3 High-temperature performance (up to +275 °C).
- 2.4 Excellent frequency response.
- 2.5 Stable high frequency characteristic with reduced lead inductance.
- 2.6 All welded construction.
- 2.7 Metal Strip resistive material stable and ultra low TCR. Low and Stable TCR $\leq \pm 50 \text{ppm}/^\circ\text{C}$.
- 2.8 Pure tin plating provides compatibility with lead (Pb) free and lead containing soldering processes.
- 2.9 Compatible with “Restriction of the use of Hazardous Substances” (RoHS) directive 2002/95/EC (issue 2004).
- 2.10 PFOS, PFOA, PAHs and REACH compliant.
- 2.11 Excellent stability ($|\Delta R/R| \leq \pm 0.5 \%$ for 1000 h at 100 °C) different environmental conditions.
- 2.12 High volume product suitable for commercial and special applications.
- 2.13 Suitable for high precision current sensing circuit protection application.
- 2.14 Miniature size suitable for compact Print Circuit Boards of high-precision electronic products.

3. Product Applications:

- 3.1 Power Supply.
- 3.2 Battery Pack.
- 3.3 DIY Tools.
- 3.4 Inverter/Converter (AC/DC, DC/DC, DC/AC).
- 3.5 Measurable Instrument.
- 3.6 Consumer Electrics.
- 3.7 Note Book.
- 3.8 PC Power Pack.
- 3.9 LED Driver.
- 3.10 Others (Auto Tronics... etc.).

4. Product Description:

- 4.1 The resistors are constructed in a high grade Materials. Internal metal electrodes are added at each end and connected by a resistive paste that is applied to the top surface of the metal alloy.
- 4.2 The resistive layer is covered with a protective coat, and two external end terminations are added. Wrap-around terminations have an electroplated nickel barrier and Lead-Tin or pure Tin (lead free) or matte-tin finish, ensuring excellent 'leach' resistance properties and solderability.

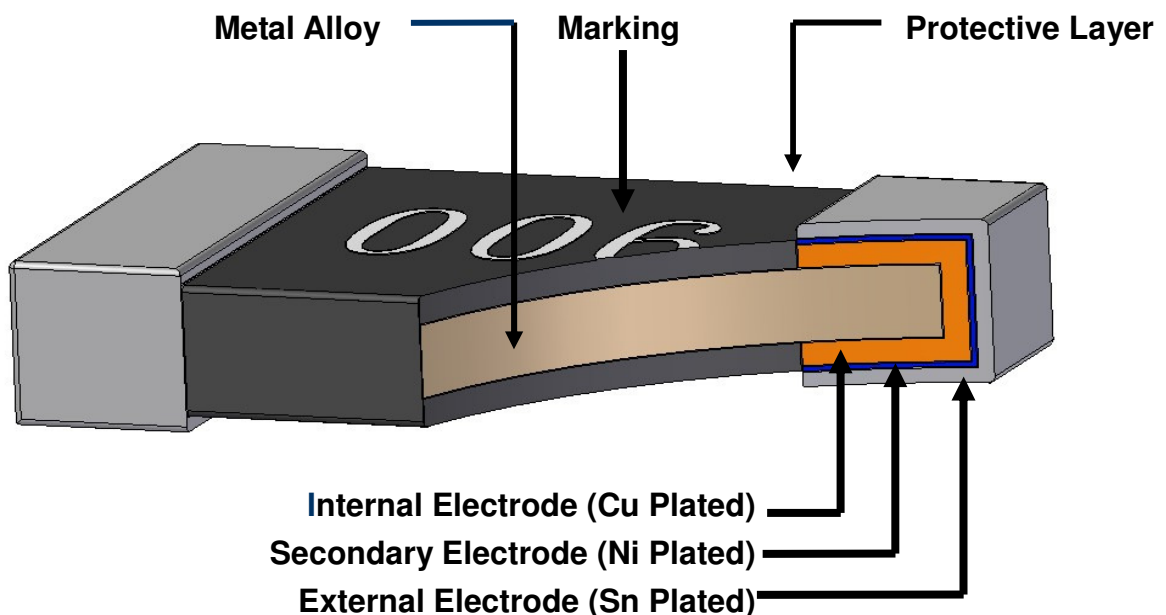

5. Product Specifications:

Type	# of Terminals	Max. Rating Power	Max. Rating Current	Max. Overload Current	TCR (ppm/°C)	Resistance Range (mΩ)**		Operating Temperature
						D (±0.5%)	F (±1%); G (±2%); J (±5%)	
LR1206		0.5W	22.36A	44.72A	1.0~4.0m : +50 4.1~15.0m : -25 15.1~50.0m : -15	7.0~50.0	1.0~50.0	-65~+275 °C
		1W	31.62A	63.25A	1.0~4.0m : +50 4.1~15.0m : -25 15.1~50.0m : -15	7.0~50.0	1.0~50.0	
LR2010		1W	31.62A	63.25A	1.0~3.0m : +50 3.1~6.9m : -25 7.0~100m : -15	3.0~100	1.0~100	
LR2512	2	1W	44.72A	100.00A	0.5~3.0m : +50 3.1~6.9m : -25 7.0~100m : -15	7.0~100	0.5~100	
		1.5W	54.77A	122.48A	7.0~100m : -15			
		2W	63.25A	141.42A	0.5~3.0m : +50 3.1~6.9m : -25 7.0~75.0m : -15	7.0~75.0	0.5~75.0	
		3W	77.46A	134.16A	0.5~2.0m : +50 2.1~10.0m : -25	7.0~10.0	0.5~10.0	
LR2725		4W	126.49A	252.95A	0.25~0.9m : +50 1.0~3.0m : -25	--	0.25~3.0	
LR2728		3W	27.39A	47.43A	4.0~7.0m : -25 7.1~100m : -15	4.0~100	4.0~100	
		3.5W	29.58A	51.23A	4.0~7.0m : -25 7.1~100m : -15	4.0~100	4.0~100	
		4W	31.62A	63.25A	4.0 ~ 7.0m : -25 7.1 ~ 50.0m : -15	4.0~50.0	4.0~50.0	

Remark:

- The Max. Power Rating is operated at 100 °C.
- “**” special tolerance and range of resistance are under requested.

6. Power Derating Curve:

6.1 The Category Temperature Range: -65°C ~+275°C.

6.2 For resistors operated in ambient temperatures above 100°C, power rating must be derated in accordance with the curve below:

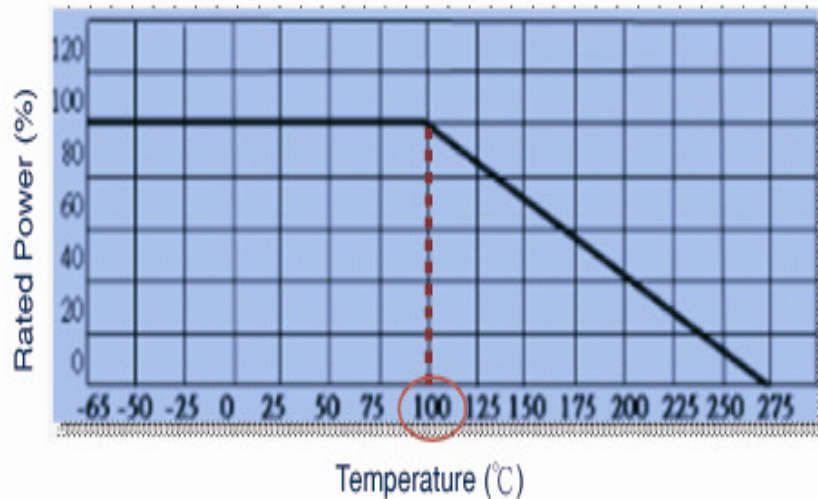

7. Rating Current:

7.1 The following equation may be used to determine the DC (Direct Current) or AC (Alternating Current) currents (RMS, root mean square value) of normal rated power. However, if the result value exceeds the highest current of regulated standards (paragraph 5), the highest normal rated power is to be used.

$$I = \sqrt{P/R}$$

Remark:

- a. I: Rating Current.
- b. P: Rating Power.
- c. R: Resistance.

8. Order Information:

Model (Size)	Number of Terminals	Power Rating (Watts)	Resistance*	Tolerance** (D=±0.5%; F=±1.0%; G=±2%); J=±5.0%)	Packing***
<u>LR1206</u>	<u>2</u>	<u>C</u> (0.5W)	<u>R001</u> EX : R001=1mΩ ; R010=10mΩ	<u>F</u>	<u>4</u> or <u>2</u>
<u>LR1206</u>	<u>2</u>	<u>1</u>	<u>R001</u> EX : R001=1mΩ ; R010=10mΩ	<u>F</u>	<u>4</u> or <u>2</u>
<u>LR2010</u>	<u>2</u>	<u>1</u>	<u>R001</u> EX : R001=1mΩ ; R100=100mΩ	<u>F</u>	<u>2</u>
<u>LR2512</u>	<u>2</u>	<u>1</u>	<u>R001</u> EX : R001=1mΩ ; R0005=0.5mΩ	<u>F</u>	<u>2</u> or <u>1</u>
<u>LR2512</u>	<u>2</u>	<u>A</u> (1.5W)	<u>R001</u> EX : R001=1mΩ ; R010=10mΩ	<u>F</u>	<u>2</u> or <u>1</u>
<u>LR2512</u>	<u>2</u>	<u>2</u>	<u>R001</u> EX : R001=1mΩ ; R010=10mΩ	<u>F</u>	<u>2</u> or <u>1</u>
<u>LR2512</u>	<u>2</u>	<u>3</u>	<u>R001</u> EX : R001=1mΩ ; R010=10mΩ	<u>F</u>	<u>2</u> or <u>1</u>
<u>LR2725</u>	<u>2</u>	<u>4</u>	<u>R001</u> EX : R001=1mΩ ; R00025=0.25mΩ	<u>F</u>	<u>1</u>
<u>LR2728</u>	<u>2</u>	<u>3</u>	<u>R004</u> EX : R004=4mΩ ; R010=10mΩ	<u>F</u>	<u>1</u>
<u>LR2728</u>	<u>2</u>	<u>B</u> (3.5W)	<u>R004</u> EX : R004=4mΩ ; R010=10mΩ	<u>F</u>	<u>1</u>
<u>LR2728</u>	<u>2</u>	<u>4</u>	<u>R004</u> EX : R004=4mΩ ; R010=10mΩ	<u>F</u>	<u>1</u>

Remark:

- a. “*” normal product order information has 4 digits, if includes one decimal point then the order information should be 5 digits (e.g. 0.5mΩ is R0005), if includes 2 decimal points, then it should be 6 digits (e.g. 0.25mΩ is R00025).

- b. “**” Special tolerance and range of resistance are under requested.
- c. “***” The packing quantity per reel for the product of LR1206 and LR2512 series are listed below:

Model	Standard (per reel)	Optional (per reel)
LR1206 series	4,000 pieces	2,000 pieces
LR2512 series	2,000 pieces	1,000 pieces

9. Physical Dimensions:

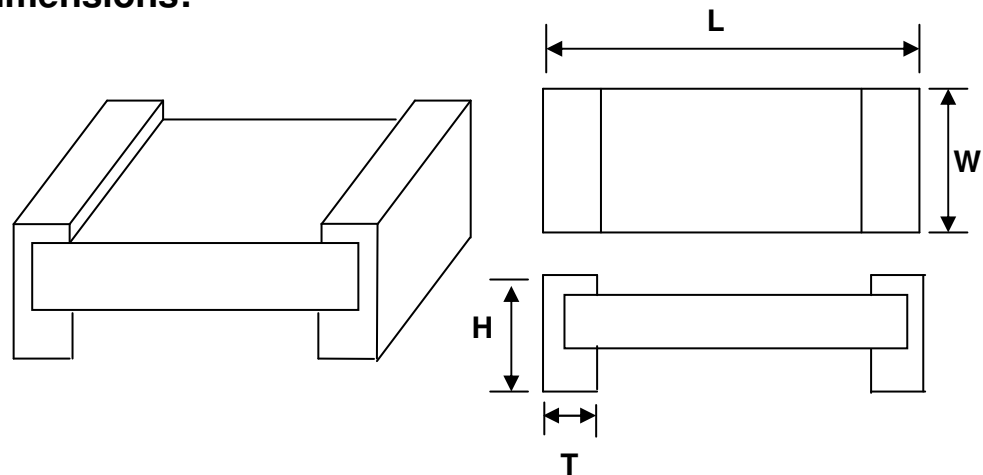

Type	Maximum Power Rating (Watts)	Resistance Range (mΩ)	Dimensions - in inches (millimeters)			
			L	W	H	T
LR1206	0.5 & 1.0	1.0 ~ 50.0	0.120±0.010 (3.048±0.254)	0.062±0.010 (1.575±0.254)	0.0254±0.010 (0.645±0.254)	0.020±0.010 (0.508±0.254)
LR2010	1.0	1.0 ~ 3.0	0.200±0.010 (5.080±0.254)	0.100±0.010 (2.540±0.254)	0.031±0.010 (0.787±0.254)	0.051±0.010 (1.295±0.254)
		3.1 ~ 100.0			0.0254±0.010 (0.645±0.254)	0.031±0.010 (0.787±0.254)
LR2512	1.0 & 1.5	0.5 ~ 4.0	0.246±0.010 (6.248±0.254)	0.130±0.010 (3.302±0.254)	0.031±0.010 (0.787±0.254)	0.074±0.010 (1.880±0.254)
		4.1 ~ 75.0			0.0254±0.010 (0.645±0.254)	0.044±0.010 (1.118±0.254)
		75.1 ~ 100.0			0.0254±0.010 (0.645±0.254)	0.034±0.010 (0.868±0.254)
LR2512	2.0	0.5 ~ 4.0	0.246±0.010 (6.248±0.254)	0.130±0.010 (3.302±0.254)	0.031±0.010 (0.787±0.254)	0.074±0.010 (1.880±0.254)
		4.1 ~ 75.0			0.0254±0.010 (0.645±0.254)	0.044±0.010 (1.118±0.254)
LR2512	3.0	0.5	0.246±0.010 (6.248±0.254)	0.130±0.010 (3.302±0.254)	0.031±0.010 (0.787±0.254)	0.074±0.010 (1.880±0.254)
		0.6 ~ 2.9 & 4.1 ~ 10.0				0.044±0.010 (1.118±0.254)
		3.0 ~ 4.0				0.066±0.010 (1.676±0.254)

LR2725	4.0	0.25, 0.50	0.268±0.010 (6.807±0.254)	0.254±0.010 (6.452±0.254)	0.039±0.010 (0.991±0.254)	0.085±0.010 (2.159±0.254)
		1.0			0.043±0.010 (1.092±0.254)	
		1.5			0.039±0.010 (0.991±0.254)	
		2.0			0.035±0.010 (0.889±0.254)	0.071±0.010 (1.803±0.254)
		2.5				0.065±0.010 (1.651±0.254)
		3.0				0.051±0.010 (1.295±0.254)
LR2728	3.0、3.5 & 4.0	4.0~100.0	0.264±0.010 (6.706±0.254)	0.283±0.010 (7.188±0.254)	0.039±0.010 (0.991±0.254)	0.045±0.010 (1.143±0.254)

10. Product Reliability Performance:

10.1 Electrical Performance:

Test Item	Conditions of Test	Test Method	Test Limits
Temperature Coefficient of Resistance (TCR)	$\text{TCR (ppm/}^\circ\text{C)} = \frac{R_2 - R_1}{R_1 (T_2 - T_1)} \times 10^6$ <ul style="list-style-type: none"> R1 : resistance of room temperature (T1) R2 : resistance of 150 °C (T2) 	JIS C 5201-1 4.8	Per Spec. (refer to paragraph 5)
Short Time Overload	The number of rated power are as follows: <ul style="list-style-type: none"> LR1206-0.5W : 4 times rated power LR1206-1W : 4 times rated power LR2010-1W : 4 times rated power LR2512-1W : 5 times rated power LR2512-1.5W : 5 times rated power LR2512-2W : 5 times rated power LR2512-3W : 3 times rated power LR2725-4W : 4 times rated power LR2728-3W : 3 times rated power LR2728-3.5W : 3 times rated power LR2728-4W : 4 times rated power Rating power duration: 5secs	JIS C 5201-1 4.13	$\pm(0.5\%+0.0005\Omega)\Delta R$
Insulation Resistance	100±15V _{DC} for 1 minute	JIS C 5201-1 4.6	$\geq 10^9\Omega$
Dielectric Withstanding Voltage	Applied 500V _{AC} for 1 minute, and Limit surge current 50 mA (max.)	JIS C 5201-1 4.7	Without break down

10.2 Mechanical /Constructional Performance:

Test Item	Conditions of Test	Test Method	Test Limits
Resistance to Solder Heat	Solder temp./immersion time: 260±5 °C, 10±1secs and 350±10 °C, 3.5±0.5secs	JIS C 5201-1 4.18	±(0.5%+0.0005Ω)△R
Solderability test	Specimen prep.: 4 hours ± 15 min. Steam Aging ; Solder Bath/Dip and Look Test, 245±5 °C, 3±1secs	JIS C 5201-1 4.17	95% coverage
Vibration	Frequency varied 55Hz in one minute, 3 orientations @ Total duration 12 hours	JIS C 5201-1 4.22	±(0.5%+0.0005Ω)△R
Resistance to solvent	Immersion time: 60±5secs @ 20 °C~25 °C	JIS C 5201-1 4.29, 4.30	±(0.5%+0.0005Ω)△R
Mechanical Shock	100 grams for 6 milliseconds, 5 pulses	JIS C 5201-1 4.21	±(0.5%+0.0005Ω)△R

10.3 Environmental Performance:

Test Item	Conditions of Test	Test Method	Test Limits
Low Temperature Exposure (Storage)	1,000 hours @ -55 °C	JIS C 5201-1 4.23.4	±(0.5%+0.0005Ω)△R
High Temperature Exposure (Storage)	1,000 hours @ + 155 °C	JIS C 5201-1 4.23.2	±(1.0%+0.0005Ω)△R
Temperature Cycling (Rapid Temperature Change)	Air to air, - 55 °C to + 150 °C, 1,000 cycles, 15 minutes at each extreme, transition time 2 to 3 minutes	JIS C 5201-1 4.19	±(0.5%+0.0005Ω)△R
Moisture Resistance (Climatic Sequence)	Mil-STD-202, Method 106, 0% power, 7a and 7b not required, t = 24 h/cycle, 10 cycles, Unpowered,	JIS C 5201-1 4.23	±(0.5%+0.0005Ω)△R
Bias Humidity	+ 85 °C, 85% RH, 10% Bias, Extended Life Test: 1,000 hours, 1.5 hours On, 0.5 hours Off	JIS C 5201-1 4.24	±(0.5%+0.0005Ω)△R

10.4 Operational Life Endurance:

Test Item	Conditions of Test	Test Method	Test Limits
Load Life	Test temperature 100 °C Rated continuous working voltage, Extended Life Test: 1,000 hours, 1.5 hours On · 0.5 hours Off	JIS C 5201-1 4.25.1	±(1.0%+0.0005Ω)△R

11. Recommend Solder Pad Dimensions:

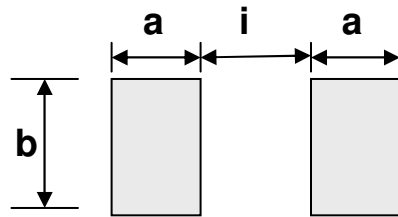

Type	Maximum Power Rating (Watts)	Resistance Range (mΩ)	Dimensions - in inches (millimeters)		
			a	b	i
LR1206	0.5 & 1.0	1.0 ~ 50.0	0.063 (1.60)	0.086 (2.18)	0.026 (0.66)
LR2010	1.0	1.0 ~ 3.0	0.071 (1.80)	0.115 (2.92)	0.048 (1.22)
		3.1 ~ 100.0	0.090 (2.29)	0.115 (2.92)	0.095 (2.41)
LR2512	1.0 & 1.5	0.5 ~ 4.0	0.120 (3.05)	0.145 (3.68)	0.050 (1.27)
		4.1 ~ 100.0	0.083 (2.11)	0.145 (3.68)	0.125 (3.18)
LR2512	2.0	0.5 ~ 4.0	0.120 (3.05)	0.145 (3.68)	0.050 (1.27)
		4.1 ~ 75.0	0.083 (2.11)	0.145 (3.68)	0.125 (3.18)
LR2512	3.0	0.5 ~ 1.5	0.120 (3.05)	0.145 (3.68)	0.050 (1.27)
		1.6 ~ 10.0	0.083 (2.11)	0.145 (3.68)	0.125 (3.18)
LR2725	4.0	0.25 ~ 3.0	0.125 (3.18)	0.270 (6.86)	0.052 (1.32)
LR2728	3.0、3.5 & 4.0	4.0 ~ 100.0	0.108 (2.75)	0.308 (7.82)	0.138 (3.51)

Remark:

- 0.5 & 1.0 Watts with total solder pad trace size of 100 mm².
- 1.5 Watts with total solder pad trace size of 200 mm².
- 2.0 Watts with total solder pad trace size of 300 mm².
- 3.0 Watts with total solder pad trace size of 300 mm².
- 3.5 Watts with total solder pad trace size of 300 mm².
- 4.0 Watts with total solder pad trace size of 400 mm².

12. Recommend Soldering Conditions:

12.1 Surface-mount components are tested for solderability at a temperature of 245 °C for 3 seconds. Typical examples of soldering processes that provide reliable joints without any damage are given in below:

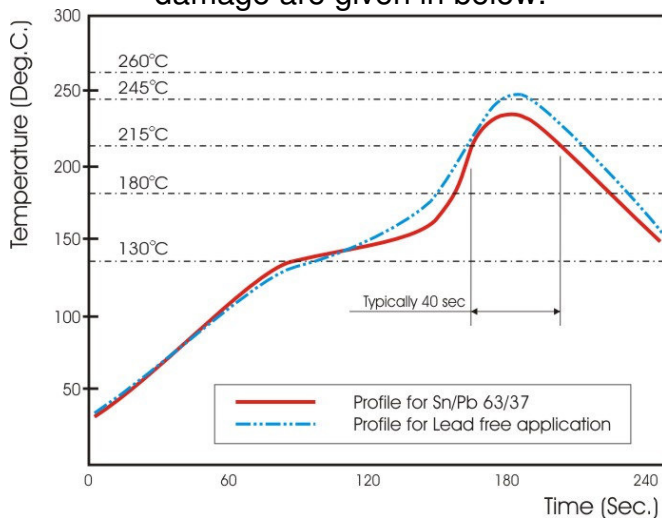

Recommended IR Reflow Soldering Profile

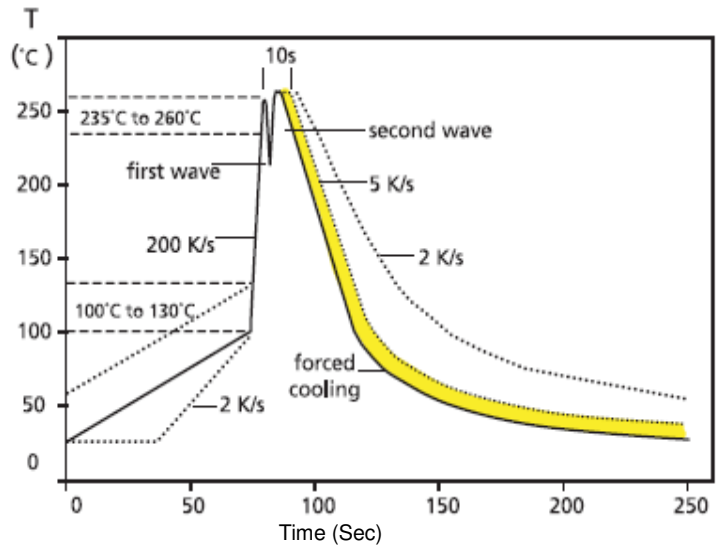

Recommended double-wave Soldering Profile

Typical values (solid line)

Process limits (dotted line)

13. Marking Format:

13.1 LR1206 series:



Ex. Resistance 10mΩ (3 digits for all LR1206 products)

Note: The marking for the product of 001mΩ, 006mΩ, and 009mΩ will be under line for identification

13.2 LR2010 series:

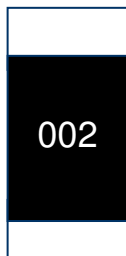

Ex. Resistance 2mΩ (3 digits when resistance below or equal than 3mΩ)

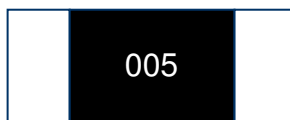

Ex. Resistance 5mΩ (3 digits when resistance greater than 3mΩ)

Note: The marking for the product of 001mΩ, 006mΩ, 009mΩ, 060mΩ, 090mΩ and 100mΩ will be under line for identification

13.3 LR2512 series:

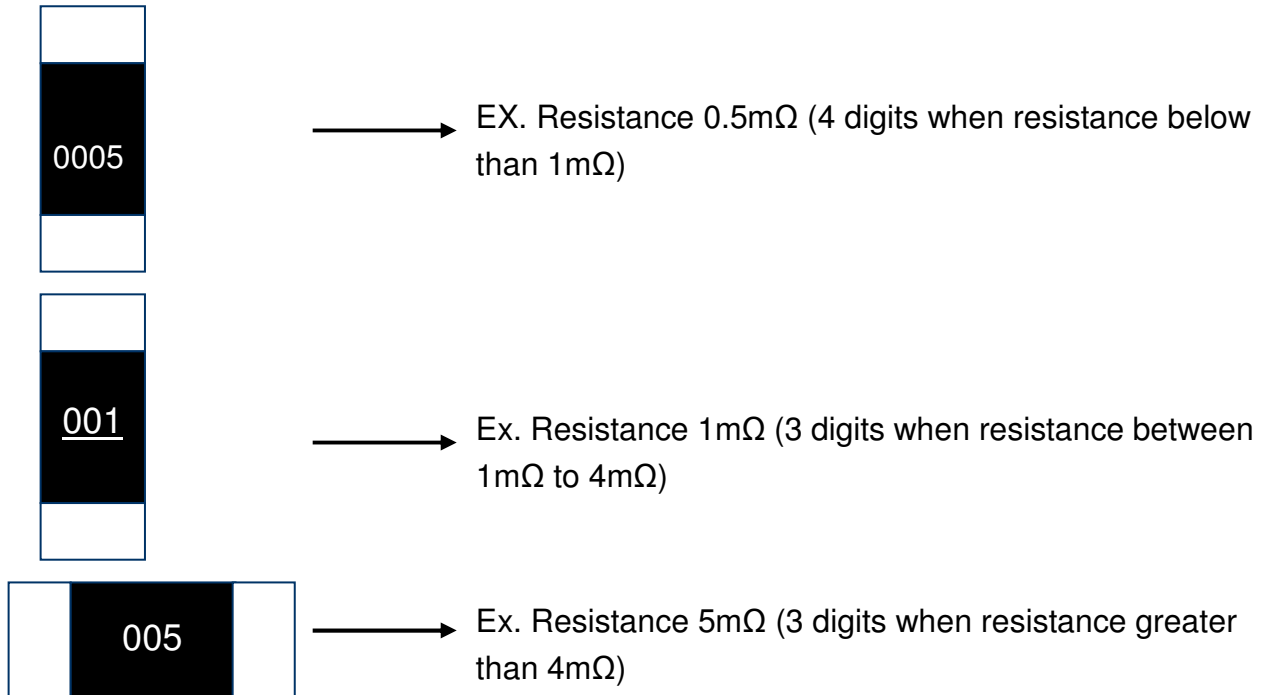

Note: The marking for the product of 001mΩ, 006mΩ, 009mΩ, 060mΩ, 090mΩ and 100mΩ will be under line for identification

13.4 LR2725 series:

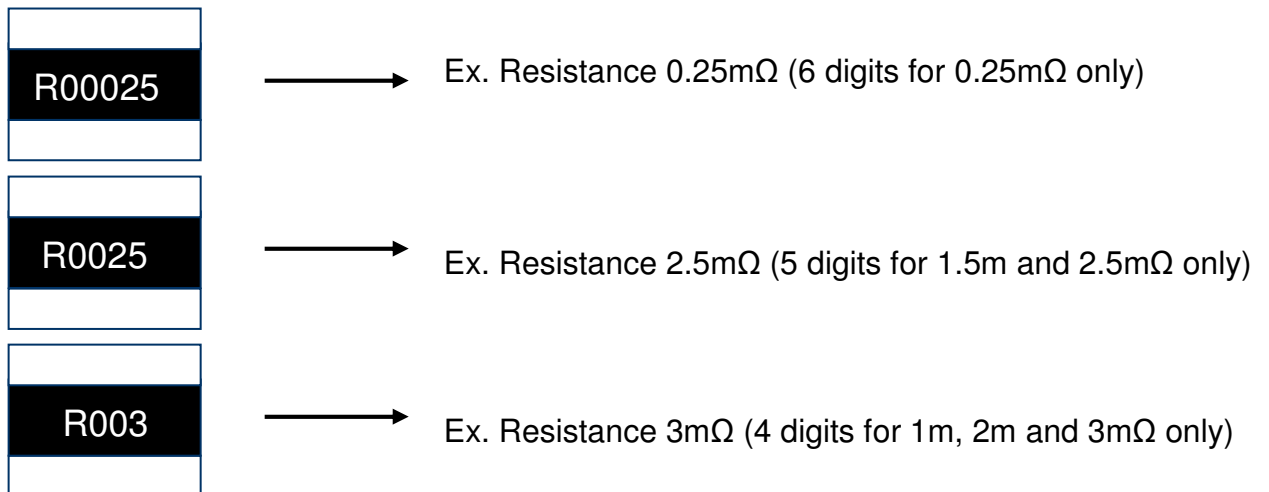

13.5 LR2728 series:

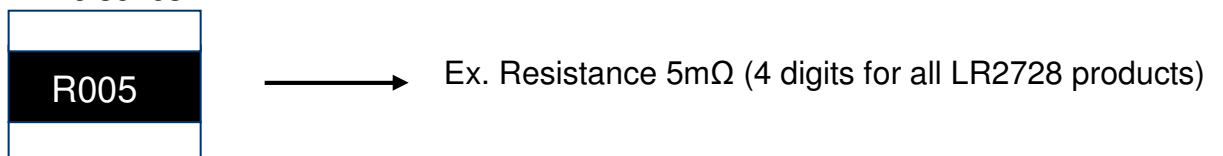

14. Packaging:

14.1 Embossed Dimensions:

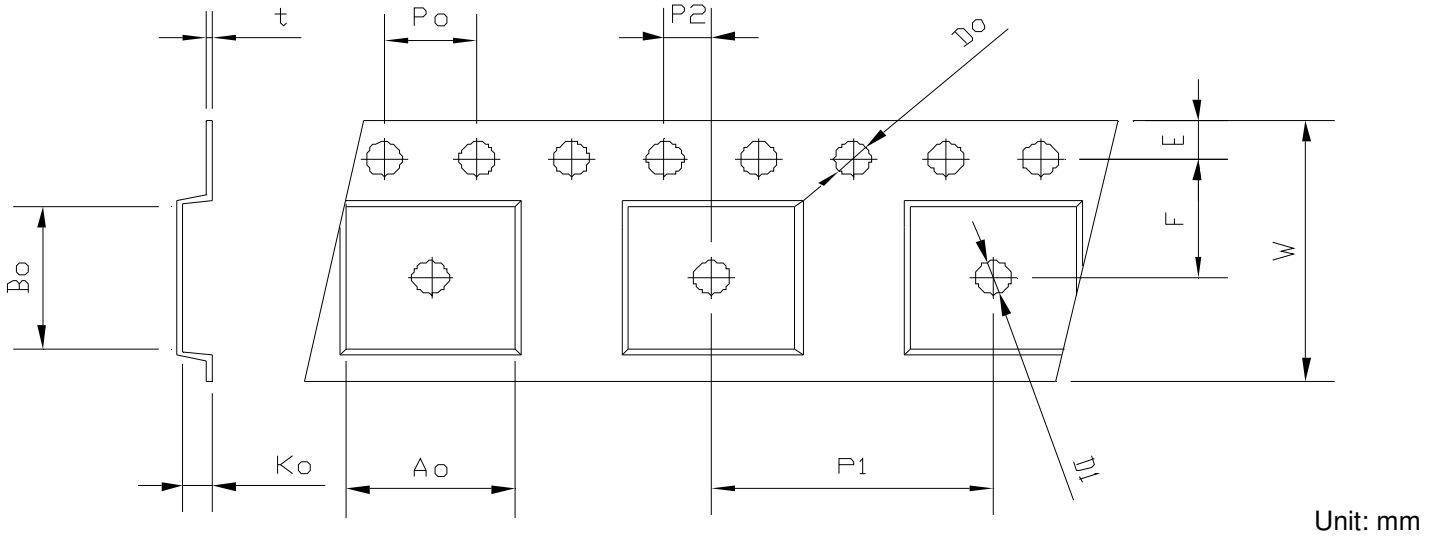

Item	W	P1	E	F	Do	D1	P0	Po*10	P2	Ao	Bo	Ko	t
LR1206	8.00	4.00	1.75	3.50	1.55	1.00	4.00	40.00	2.00	1.83	3.50	0.90	0.20
LR2010	12.00	4.00	1.75	5.50	1.50	1.50	4.00	40.00	2.00	2.90	5.45	1.10	0.23
LR2512	12.00	8.00	1.75	5.50	1.55	1.50	4.00	40.00	2.00	3.90	6.74	1.08	0.24
LR2725	12.00	8.00	1.75	5.50	1.50	1.50	4.00	40.00	2.00	6.75	7.15	1.70	0.25
LR2728	12.00	12.00	1.75	5.50	1.55	1.55	4.00	40.00	2.00	7.70	7.15	1.20	0.25
Tolerance	±0.15	±0.10	±0.10	±0.10	±0.05	±0.10	±0.10	±0.20	±0.10	±0.10	±0.10	±0.10	±0.05

14.2 Reel Dimensions:

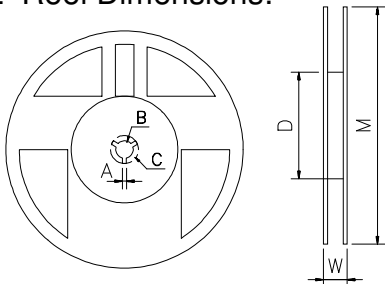

Unit: mm

Reel Type / Tape	W	M	A	B	C	D
7" reel for 12 mm embossed	16.2 ± 0.5	178 ± 1.0	2.5 ± 0.5	13.5 ± 0.5	17.7 ± 0.5	60.0 ± 0.5
7" reel for 8 mm embossed (for LR1206 only)	12.00 ± 0.5	178 ± 1.0	2.0 ± 0.5	13.2 ± 0.5	17.7 ± 0.5	60.0 ± 0.5

14.3 Inner Box Dimensions:

# of reel	D dimension (LR1206 only)	D dimension (Other series)
1	16	24
2	24	36
3	36	58
4	48	72
5	58	83

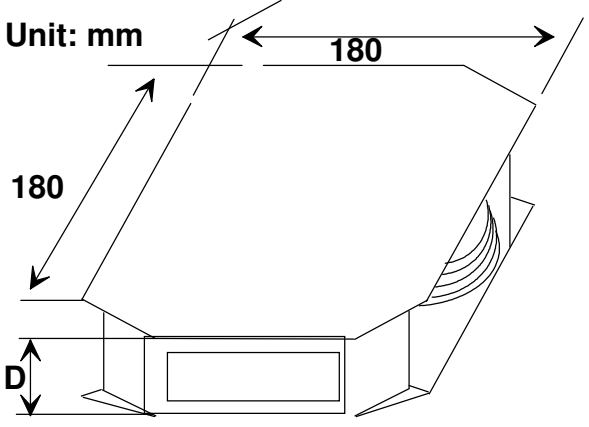

14.4 Outer Box Dimensions:

# of inner box	L (mm)	W (mm)	D (mm)
5	195	130	200
10	195	185	200
20	375	185	200
30	375	270	200

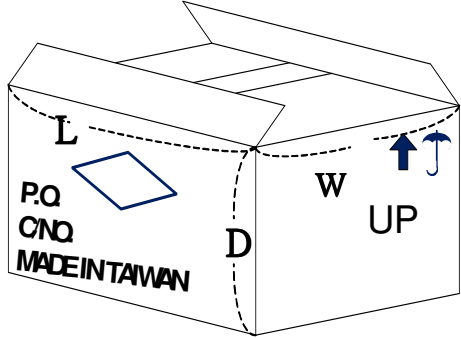

14.5 Labeling Requirements:

