

sgdconn electronics Co.,Ltd

Http://www.sgdconn.com

E-mail:shangudao@163.com

0.8mm BOARD TO BOARD FEMALE TYPE

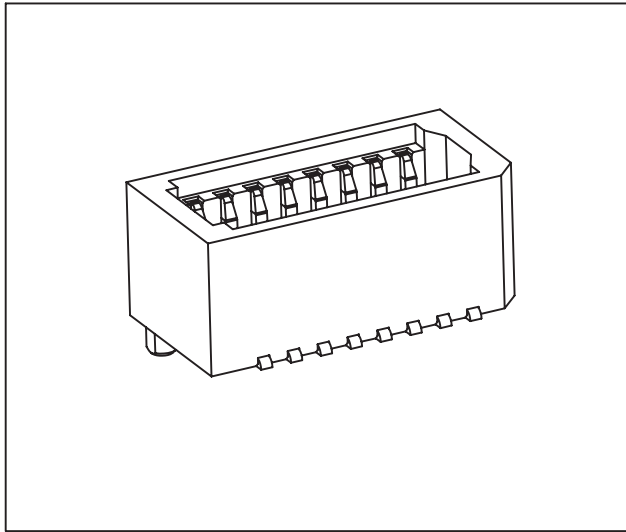

ORDERING INFORMATION

B 2 F XX U - C X S 8
 (1) (2) (3) (4) (5)(6)(7)(8)

1. SERIES NO.
2: 0.8mm BOARD TO BOARD CONNECTOR
2. MALE & FEMALE TYPE
F: FEMALE
3. NUMBER OF PIN
XX: XX POSITIONS
4. TAIL CONSTRUCTION TYPE
U: SMD TYPE
5. HOUSING COLOR CODES AND MATERIAL
C: COLOR:WHITE COLOR AND MATERIAL:NYLON 9T
6. CONTACT PLATING
1: GOLD FLASH OVER ALL
2: 15u" GOLD PLATING OVER ALL
3: 30u" GOLD PLATING OVER ALL
7. MALE AND FEMALE MATING TYPE
S: STRAIGHT
8. PRODUCT HEIGHT
8: PRODUCT HEIGHT:3.50mm

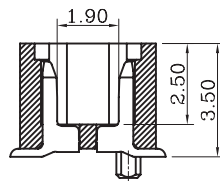
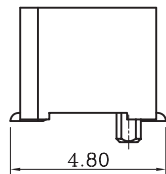
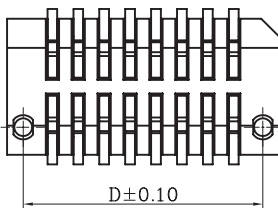
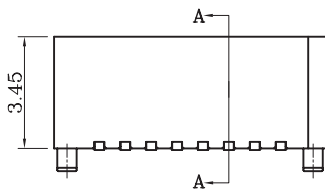
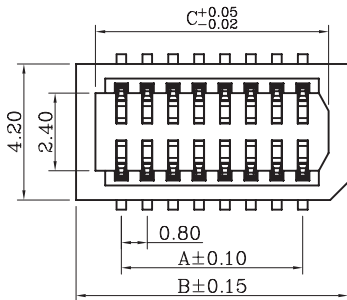

SECTION:A-A

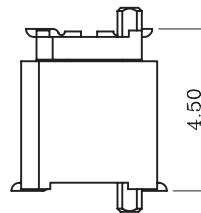

MATING HEIGHT:4.5mm

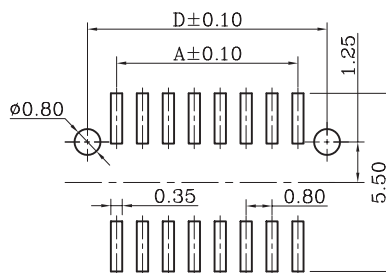

RECOMMENDED P.C.B LAYOUT

CIRCUITS	DIM	ADIM	B	DIM	CDIM	D
2x5	3.20	6.00	4.80	5.00		
2x6	4.00	6.80	5.60	5.80		
2x7	4.80	7.60	6.40	5.60		
2x8	5.60	8.40	7.20	7.40		
2x9	6.40	9.20	8.00	8.20		
2x10	7.20	10.00	8.80	9.00		
2x11	8.00	10.80	9.60	9.80		
2x12	8.80	11.60	10.40	10.60		
2x13	9.60	12.40	11.20	11.40		
2x14	10.40	13.20	12.00	12.20		
2x15	11.20	14.00	12.80	13.00		
2x16	12.00	14.80	13.60	13.80		
2x17	12.80	15.60	14.40	14.60		
2x18	13.60	16.40	15.20	15.40		
2x19	14.40	17.20	16.00	16.20		
2x20	15.20	18.00	16.80	17.00		
2x21	16.00	18.80	17.60	17.80		
2x22	16.80	19.60	18.40	18.60		
2x23	17.60	20.40	19.20	19.40		
2x24	18.40	21.20	20.00	20.20		
2x25	19.20	22.00	20.80	21.00		

MATERIAL SPECIFICATION:

1. HOUSING:NYLON 9T PLASTIC(UL94V-0)
2. CONTACT:BRASS

ELECTRICAL PERFORMANCE

1. RATED VOLTAGE(MAX.):50V AC/DC
2. RATED CURRENT(MAX.):0.5A AC/DC
3. DIELECTRIC STRENGTH:250V AC FOR 1 MINUTE BETWEEN ADJACENT TERMINAL, NO BREAKDOWN
4. INSULATION RESISTANCE:1000 MEGOHMS MIN. 250V DC FOR 1 MINUTE BETWEEN ADJACENT TERMINAL
5. CONTACT RESISTANCE:40 MILLIOHM MAX.
6. OPERATION TEMPERATURE:-25° to +85°

PACKING:

TAPE & REEL PACKING

