

DESCRIPTION

The 2305 uses advanced trench technology to provide excellent $R_{DS(ON)}$, low gate charge and operation with gate voltages as low as 2.5V. This device is suitable for use as a load switch or in PWM applications.

GENERAL FEATURES

- | V_{DSS} | $R_{DS(ON)}$
@-4.5V(Typ) | $R_{DS(ON)}$
@-2.5V(Typ) | I_D |
|-----------|-----------------------------|-----------------------------|-------|
| -20V | 45 m Ω | 60m Ω | -4.8A |

- High Power and current handling capability
- Lead free product is acquired
- Surface Mount Package

Application

- PWM applications
- Load switch
- Power management

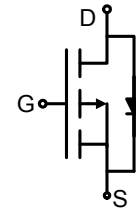

Schematic diagram

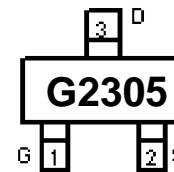

Marking and pin Assignment



SOT-23

Absolute Maximum Ratings (TA=25°C unless otherwise noted)

Parameter	Symbol	Limit	Unit
Drain-Source Voltage	V_{DS}	-20	V
Gate-Source Voltage	V_{GS}	± 12	V
Drain Current -Continuous	I_D	-4.8	A
Drain Current -Pulsed (Note 1)	I_{DM}	-15	A
Maximum Power Dissipation	P_D	1.7	W
Operating Junction and Storage Temperature Range	T_J, T_{STG}	-55 To 150	$^{\circ}C$

Thermal Characteristic

Thermal Resistance, Junction-to-Ambient (Note 2)	$R_{\theta JA}$	74	$^{\circ}C/W$
--	-----------------	----	---------------

Electrical Characteristics (TA=25°C unless otherwise noted)

Parameter	Symbol	Condition	Min	Typ	Max	Unit
Off Characteristics						
Drain-Source Breakdown Voltage	BV_{DSS}	$V_{GS}=0V, I_D=-250\mu A$	-20	-21	-	V
Zero Gate Voltage Drain Current	I_{DSS}	$V_{DS}=-20V, V_{GS}=0V$	-	-	-1	μA

Gate-Body Leakage Current	I_{GSS}	$V_{GS}=\pm 8V, V_{DS}=0V$	-	-	± 100	nA
On Characteristics (Note 3)						
Gate Threshold Voltage	$V_{GS(th)}$	$V_{DS}=V_{GS}, I_D=-250\mu A$	-0.45	-0.7	-1.0	V
Drain-Source On-State Resistance	$R_{DS(ON)}$	$V_{GS}=-4.5V, I_D=-4.1A$	-	45	50	m Ω
		$V_{GS}=-2.5V, I_D=-3A$	-	60	70	
Forward Transconductance	g_{FS}	$V_{DS}=-5V, I_D=-3.5A$	-	8.5	-	S
Dynamic Characteristics (Note4)						
Input Capacitance	C_{ISS}	$V_{DS}=-4V, V_{GS}=0V,$ $F=1.0MHz$	-	740	-	PF
Output Capacitance	C_{OSS}		-	290	-	PF
Reverse Transfer Capacitance	C_{RSS}		-	190	-	PF
Switching Characteristics (Note 4)						
Turn-on Delay Time	$t_{d(on)}$	$V_{DD}=-4V, I_D=-3.3A,$ $R_L=-1.2\Omega, V_{GEN}=-4.5V, R_g=1\Omega$	-	12	-	nS
Turn-on Rise Time	t_r		-	35	-	nS
Turn-Off Delay Time	$t_{d(off)}$		-	30	-	nS
Turn-Off Fall Time	t_f		-	10	-	nS
Total Gate Charge	Q_g	$V_{DS}=-4V, I_D=-4.1A, V_{GS}=-4.5V$	-	7.8	-	nC
Gate-Source Charge	Q_{gs}		-	1.2	-	nC
Gate-Drain Charge	Q_{gd}		-	1.6	-	nC
Drain-Source Diode Characteristics						
Diode Forward Voltage (Note 3)	V_{SD}	$V_{GS}=0V, I_S=-1.6A$	-	-	-1.2	V
Diode Forward Current (Note 2)	I_S		-	-	1.6	A

Notes:

1. Repetitive Rating: Pulse width limited by maximum junction temperature.
2. Surface Mounted on FR4 Board, $t \leq 10$ sec.
3. Pulse Test: Pulse Width $\leq 300\mu s$, Duty Cycle $\leq 2\%$.
4. Guaranteed by design, not subject to production

TYPICAL ELECTRICAL AND THERMAL CHARACTERISTICS



Figure 1: Switching Test Circuit

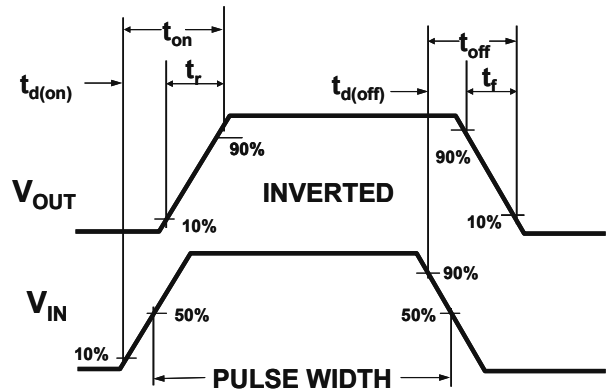

Figure 2: Switching Waveforms

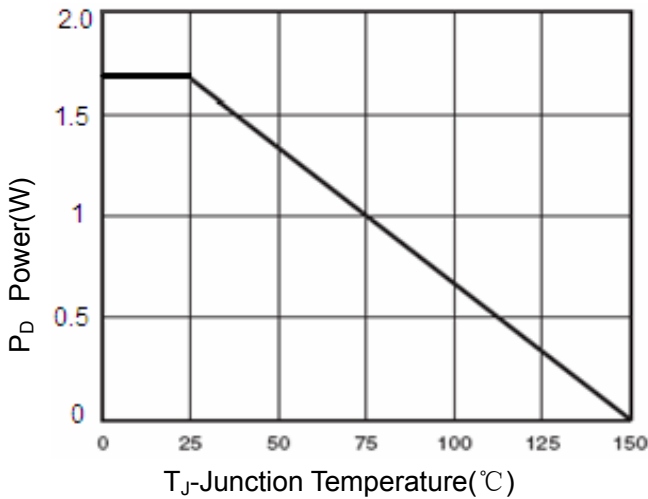

Figure 3 Power Dissipation

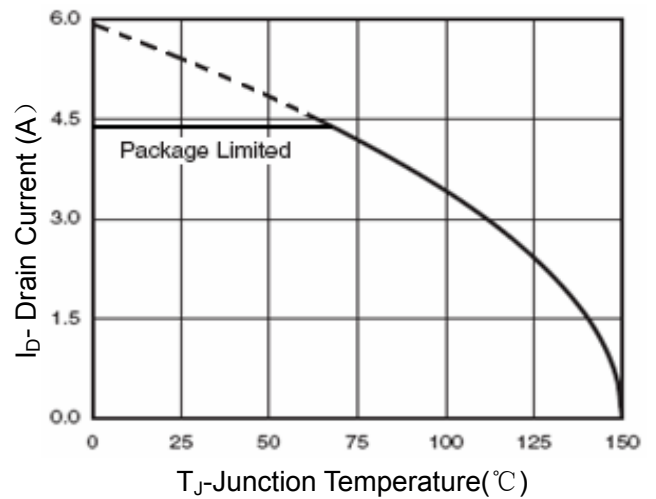

Figure 4 Drain Current

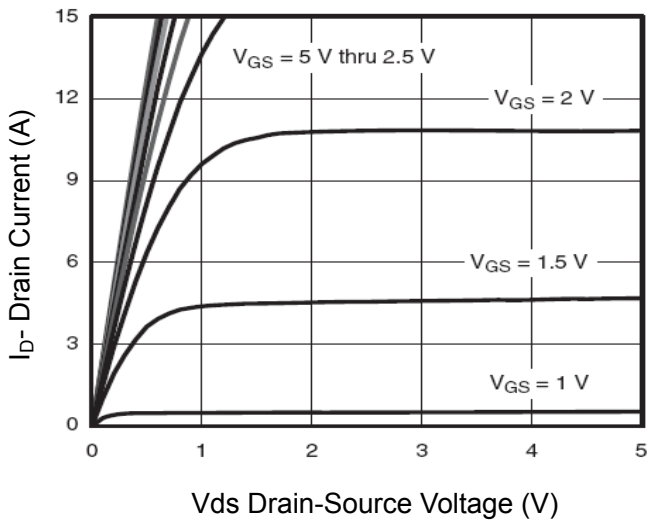

Figure 5 Output CHARACTERISTICS

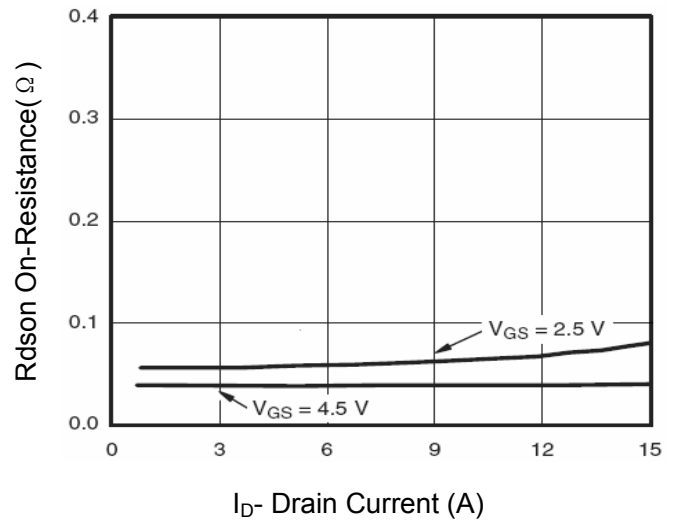
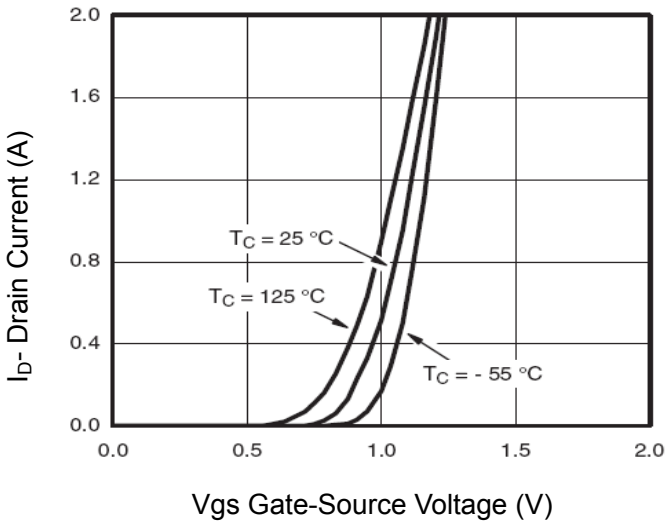
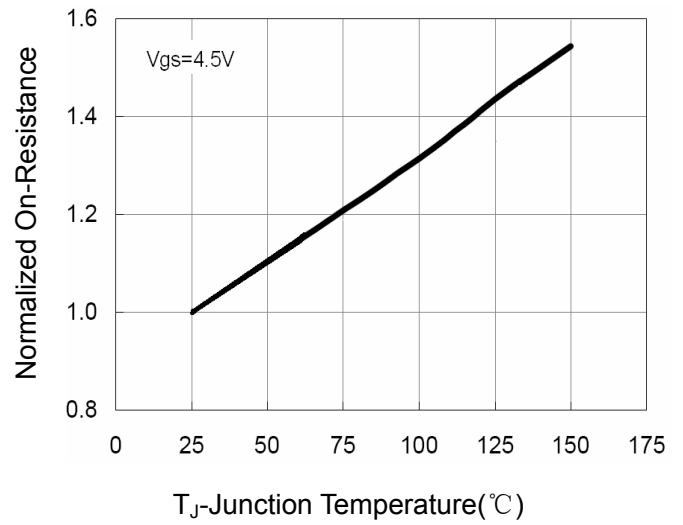

Figure 6 Drain-Source On-Resistance



Vgs Gate-Source Voltage (V)
Figure 7 Transfer Characteristics



T_J -Junction Temperature($^\circ\text{C}$)
Figure 8 Drain-Source On-Resistance

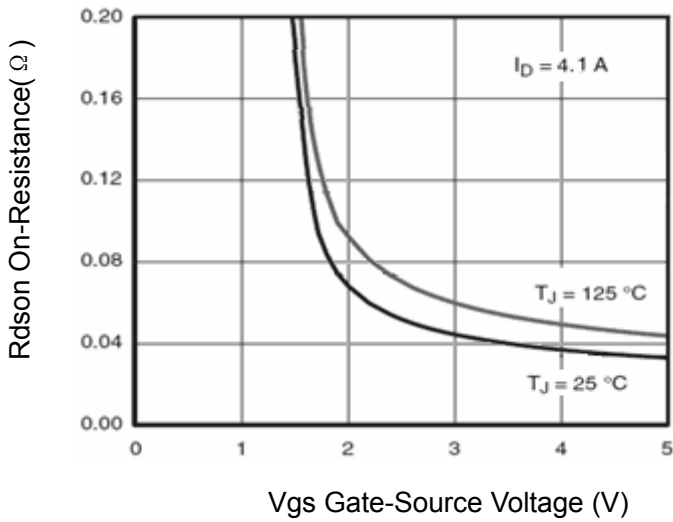

Vgs Gate-Source Voltage (V)
Figure 9 Rdson vs Vgs

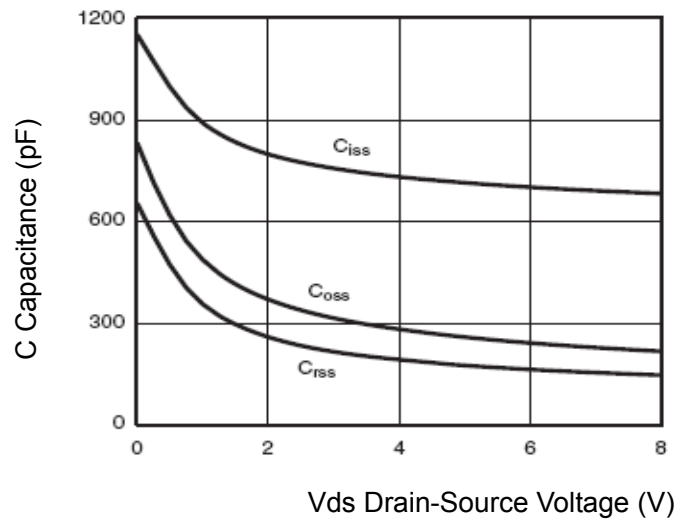

Vds Drain-Source Voltage (V)
Figure 10 Capacitance vs Vds

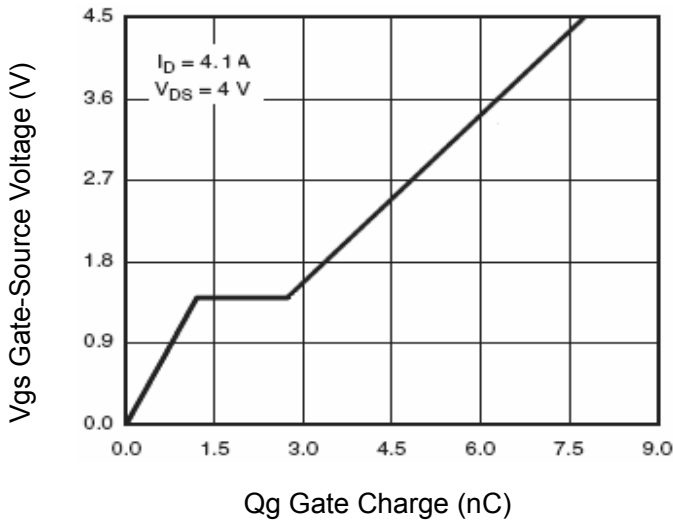

Qg Gate Charge (nC)
Figure 11 Gate Charge

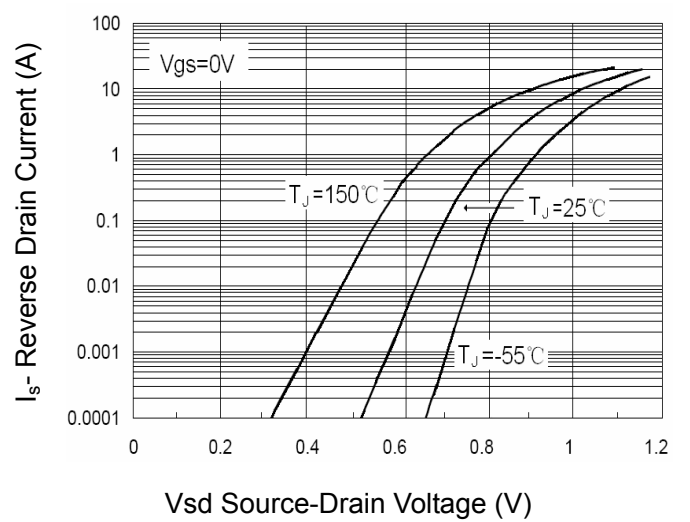

Vsd Source-Drain Voltage (V)
Figure 12 Source- Drain Diode Forward

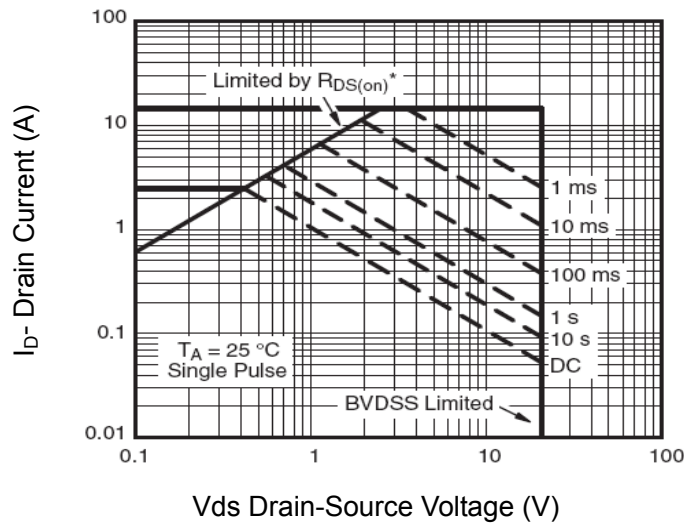

Figure 13 Safe Operation Area

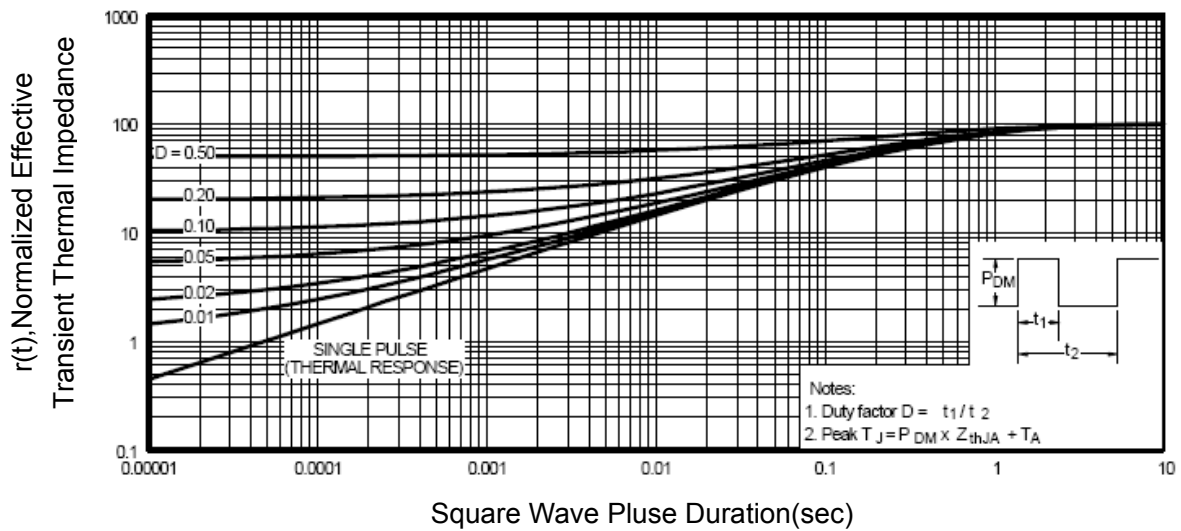

Figure 14 Normalized Maximum Transient Thermal Impedance