

# SPECIFICATIONS

<b>Customer</b>	
<b>Product Name</b>	<b>Wire Wound SMD Power Inductor</b>
<b>Sunlord Part Number</b>	<b>SWPA 3010S Series</b>
<b>Customer Part Number</b>	

New Released,  Revised]

**SPEC No.:** **SWPA120000**

Rev.	Effective Date	Changed Contents	Change Reasons	Approved By
01	/	New release	/	Qintian hou

**[This SPEC is total 10 pages.]**

**[ROHS Compliant Parts ]**

Approved By	Checked By	Issued By

## Shenzhen Sunlord Electronics Co., Ltd.

Address: Sunlord Industrial Park, Dafuyuan Industrial Zone, Baoan, Shenzhen, China 518110  
Tel: 0086-755-29832660 Fax: 0086-755-82269029 E-Mail: sunlord@sunlordinc.com

**【For Customer approval Only】**

Date: \_\_\_\_\_

Qualification Status:  Full  Restricted  Rejected

Approved By	Verified By	Re-checked By	Checked By

Comments:

\_\_\_\_\_

**1 Scope**

This specification applies to the SWPA3010S Series of wire wound SMD power inductor.

**2 Product Description and Identification (Part Number)**

- 1) Description:  
SWPA3010S series of Wire wound SMD power inductor.
- 2) Product Identification (Part Number)

SWPA 3010 S     I A01

Type	
SWPA	Wire wound SMD power inductor

External Dimensions(L×W×H) [mm]	
3010	3.0X3.0X 1.0

Feature type	
S	Standard Type

Nominal Inductance	
Example	Example
1R0	1.0uH
100	10uH
101	100uH

Inductance Tolerance	
N	±30%
M	±20%

Special Process code	
A01	Special Process code
* Standard product is blank	

Packing	
T	Tape Carrier Package

**3 Electrical Characteristics**

Please refer to **Item 12**.

- 1) Operating and storage temperature range (individual chip without packing): -40 ~ +125 ( Including Self-heating )
- 2) Storage temperature range (packaging conditions): -10 ~+40 and RH 70% (Max.)

**4 Test and Measurement Procedures**

**4.1 Test Conditions**

4.1.1 Unless otherwise specified, the standard atmospheric conditions for measurement/test as:

- a. Ambient Temperature: 20±15
- b. Relative Humidity: 65±20%
- c. Air Pressure: 86kPa to 106kPa

4.1.2 If any doubt on the results, measurements/tests should be made within the following limits:

- a. Ambient Temperature: 20±2
- b. Relative Humidity: 65±5%
- c. Air Pressure: 86kPa to 106kPa

**4.2 Visual Examination**

Inspection Equipment: 10X microscope

**4.3 Electrical Test**

4.3.1 Inductance (L)

- a. Refer to **Item 12**. Test equipment: WK3260B LCR meter or equivalent.
- b. Test Frequency and Voltage: refers to **Item 12**.

4.3.2 Direct Current Resistance (DCR)

- a. Refer to **Item 12**.
- b. Test equipment: HIOKI 3540 or equivalent.

4.3.3 Saturation Current (Isat)

- a. Refer to Item 12.
- b. Test equipment:WK3260B LCR meter or equivalent.
- c. Definition of saturation current (Isat): DC current at which the inductance drops approximate 30% from its value without current.

4.3.4 Temperature rise current (Irms)

- a. Refer to **Item 12**.
- b. Test equipment (**see Fig. 4.3.4-1, Fig. 4.3.4-2**): Electric Power, Electric current meter, Thermometer.
- c. Measurement method
  - 1. Set test current to be 0 mA.
  - 2. Measure initial temperature of choke surface.
  - 3. Gradually increase current and measure choke temperature for corresponding current.
  - 4. Definition of Temperature rise current: DC current that causes the temperature rise ( T =40°C) from 20°C ambient

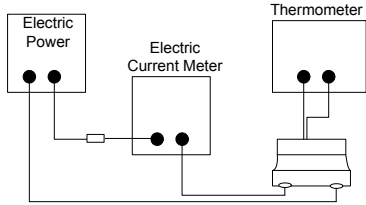

Fig. 4.3.4-1

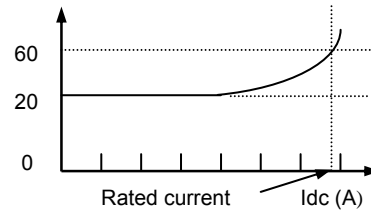

Fig. 4.3.4-2

5 Shape and Dimensions

Dimensions and recommended PCB pattern for reflow soldering, please see Fig.5-1, Fig. 5-2 and Table 5-1.

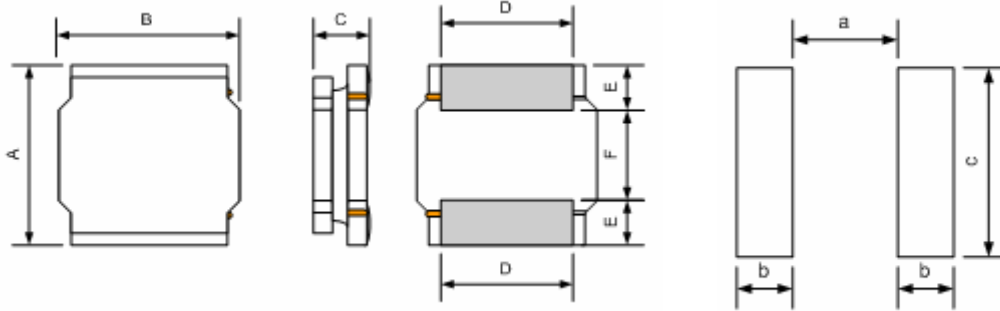

Fig.5-1 [Table 5-1] (Unit: mm)

Series	A	B	C	D	E	F	a	b	c
SWPA3010S	3.0±0.2	3.0±0.2	1.0Max.	2.5±0.2	0.75±0.2	1.5±0.2	1.5Typ.	0.8Typ.	2.7Typ.



Fig.5-2

Δf: Clearance between terminal and the surface of plate must be 0.1mm max when coil is placed on a flat plate.

6 Structure

The structure of SWPA3010S product, please refer to Fig.6-1 and Table 6-1.

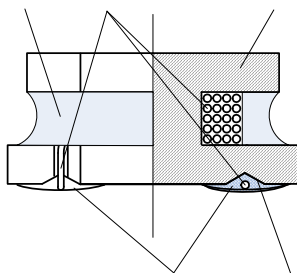

Fig. 6-1

[Table 6-1]

No.	Components	Material
	Ferrite Core	Ni-Zn Ferrite
	Wire	Polyurethane system enameled copper wire
	Magnetic Glue	Epoxy resin and magnetic powder
	Plating Electrodes	Plating: Ag/Ni/Sn
	Outer Electrodes	Top surface solder coating: Sn96.5%/Ag3.0%/Cu0.5%

7 Product Marking

N/A

8 Reliability Test

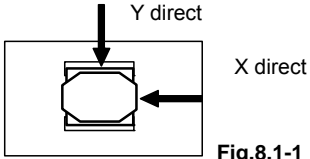
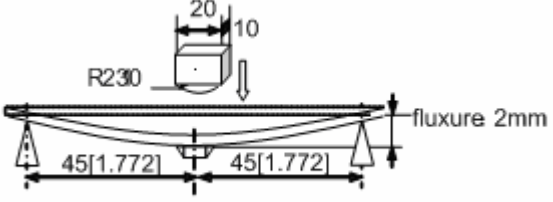
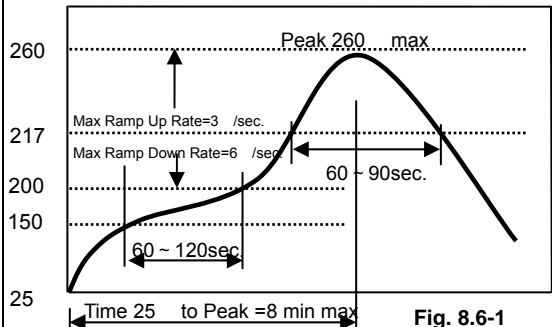
Items	Requirements	Test Methods and Remarks
8.1 Terminal Strength	No removal or split of the termination or other defects shall occur.  <p>Y direct X direct Fig.8.1-1</p>	Solder the inductor to the testing jig (glass epoxy board shown in Fig.8.1-1) using eutectic solder. Then apply a force in the direction of the arrow. 10N force. Keep time: 5s
8.2 Resistance to Flexure	No visible mechanical damage.  <p>Fig.8.2-1</p>	Solder the chip to the test jig (glass epoxy board) using eutectic solder. Then apply a force in the direction shown as Fig.8.2-1. Flexure: 2mm Pressurizing Speed: 0.5mm/sec Keep time: 30±1s Test board size: 100X40X1.0 Land dimension: Please see Fig. 5-1
8.3 Vibration	No visible mechanical damage. Inductance change: Within ±10%	Solder the chip to the testing jig (glass epoxy board shown as the following figure) using eutectic solder. The chip shall be subjected to a simple harmonic motion having total amplitude of 1.5mm, the frequency being varied uniformly between the approximate limits of 10 and 55 Hz. The frequency range from 10 to 55 Hz and return to 10 Hz shall be traversed in approximately 1 minute. This motion shall be applied for a period of 2 hours in each 3 mutually perpendicular directions (total of 6 hours).
8.4 Temperature coefficient	Inductance change: Within ±20%	Temperature: -40 ~+125 With a reference value of +20 , change rate shall be calculated
8.5 Solderability	90% or more of electrode area shall be coated by new solder.	The test samples shall be dipped in flux, and then immersed in molten solder. Solder temperature: 245±5 Duration: 5±1 sec. Solder: Sn/3.0Ag/0.5Cu Flux: 25% resin and 75% ethanol in weight Immersion depth: all sides of mounting terminal shall be immersed
8.6 Resistance to Soldering Heat	No visible mechanical damage. Inductance change: Within ±10%	Re-flowing Profile: Please refer to Fig. 8.6-1. Test board thickness: 1.0mm Test board material: glass epoxy resin The chip shall be stabilized at normal condition for 1~2 hours before measuring  <p>Fig. 8.6-1</p>

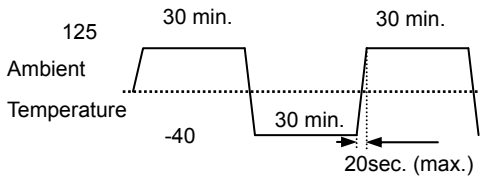
<p>8.7 Thermal Shock</p>	<p>No visible mechanical damage. Inductance change: Within <math>\pm 10\%</math></p>  <p style="text-align: center;"><b>Fig.8.7-1</b></p>	<p>Temperature and time: <math>-40\pm 3</math> for <math>30\pm 3</math> min <math>\rightarrow</math> 125 for <math>30\pm 3</math> min, please refer to <b>Fig. 8.7-1</b>. Transforming interval: Max. 20 sec Tested cycle: 100 cycles The chip shall be stabilized at normal condition for 1~2 hours before measuring</p>
<p>8.8 Resistance to Low Temperature</p>	<p>No visible mechanical damage Inductance change: Within <math>\pm 10\%</math></p>	<p>Temperature: <math>-40\pm 3</math> Duration: <math>1000^{+24}</math> hours The chip shall be stabilized at normal condition for 1~2 hours before measuring</p>
<p>8.9 Resistance to High Temperature</p>	<p>No mechanical damage. Inductance change: Within <math>\pm 10\%</math></p>	<p>Temperature: <math>125\pm 2</math> Duration: <math>1000^{+24}</math> hours The chip shall be stabilized at normal condition for 1~2 hours before measuring.</p>
<p>8.10 Damp Heat</p>	<p>No mechanical damage. Inductance change: Within <math>\pm 10\%</math></p>	<p>Temperature: <math>60\pm 2</math> Humidity: 90% to 95%RH Duration: <math>1000^{+24}</math> hours The chip shall be stabilized at normal condition for 1~2 hours before measuring</p>
<p>8.11 Loading Under Damp Heat</p>	<p>No mechanical damage. Inductance change: Within <math>\pm 10\%</math></p>	<p>Temperature: <math>60\pm 2</math> Humidity: 90% to 95% RH Applied current: Rated current Duration: <math>1000^{+24}</math> hours The chip shall be stabilized at normal condition for 1~2 hours before measuring</p>
<p>8.12 Loading at High Temperature</p>	<p>No mechanical damage. Inductance change: Within <math>\pm 10\%</math></p>	<p>Temperature: <math>85\pm 2</math> Applied current: Rated current Duration: <math>1000^{+24}</math> hours The chip shall be stabilized at normal condition for 1~2 hours before measuring</p>

9 Packaging

9.1 Tape and Reel Packaging Dimensions

9.1.1 Taping Dimensions (Unit: mm)

Please refer to **Fig. 9.1.1** and **Table 9.1.1**.

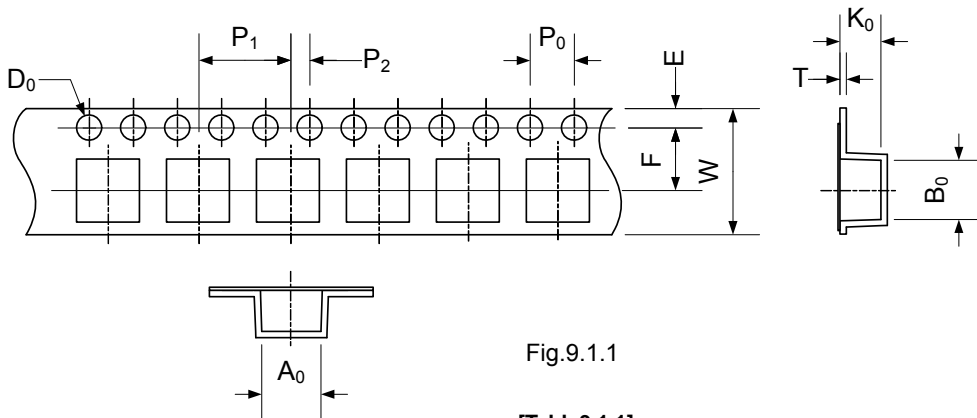

[Table9.1.1]

Series	A <sub>0</sub>	B <sub>0</sub>	W	E	F	P <sub>0</sub>	P <sub>1</sub>	P <sub>2</sub>	D <sub>0</sub>	T	K0
SWPA3010S	3.3±0.1	3.3±0.1	8.0±0.3	1.75±0.1	3.5±0.05	4.0±0.1	4.0±0.1	2.0±0.1	1.5+0.1/-0.0	0.25±0.03	1.4±0.1

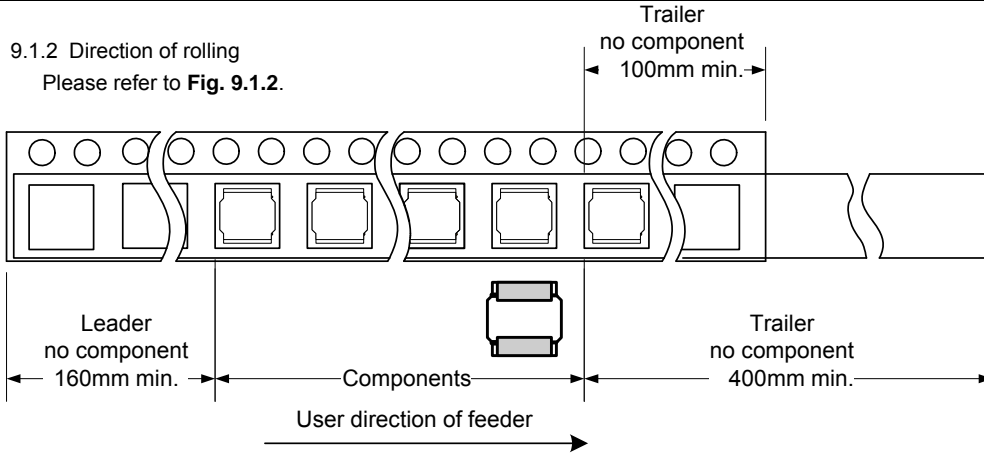

Fig. 9.1.2.

9.1.3 Reel Dimensions (Unit: mm)

Please refer to Fig. 9.1.3.

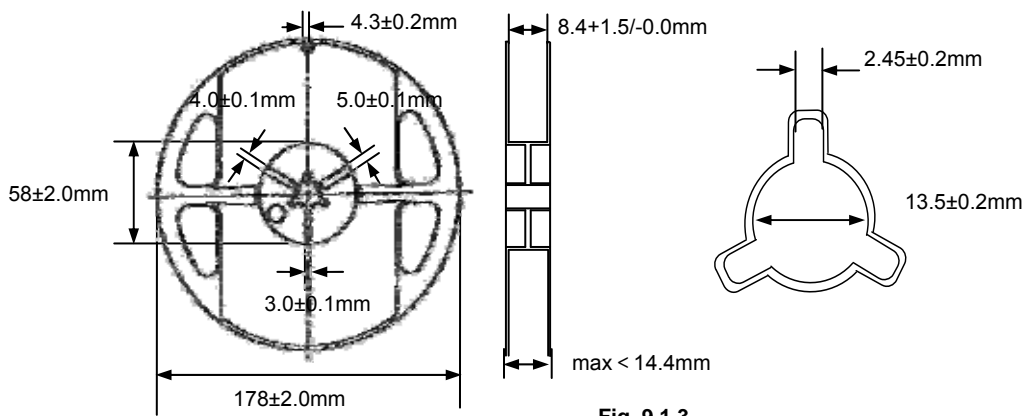

Fig. 9.1.3

9.1.4 Top tape strength

Peel-off strength: 10~100gf .

Peel-off angle: 165°~180°, refers to Fig.9.1.4.

Peel-off speed: 300mm/min.

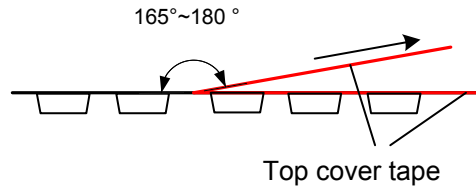

Fig. 9.1.4

9.1.5 The number of components

A tape & reel package contains 2000 inductors.

9.1.6 The allowable number of empty chip cavities

Maximum two (2) chip cavities missing product may exist in a reel but they may not be consecutive two cavities.

9.2 Packing Documents and Marking

9.2.1 Packing Documents

Packing documents include the following:

- 1) Packaging list
- 2) Certificate of compliance (COC)

9.2.2 Packing QTY.

- 1) Inner Box: 10 reels in each box.
- 2) Outer Box: 4 or 8 inner boxes in each outer case.
- 3) 40 or 80 reels in each outer case.

9.2.3 Marking

1) Marking label information on reels includes (see Fig.9.2.3-1, Fig.9.2.3-2A/2B):

- a). Sunlord P/N.
- b). Quantity per reel
- c). Lot number
- d). Inspection No.
- e). Inspection stamp
- f). MFG address as 'Made In China'

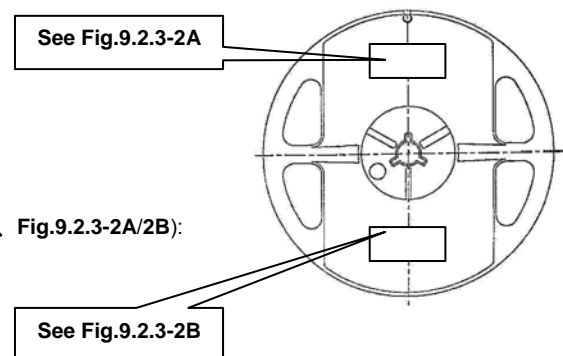

Fig.9.2.3-1

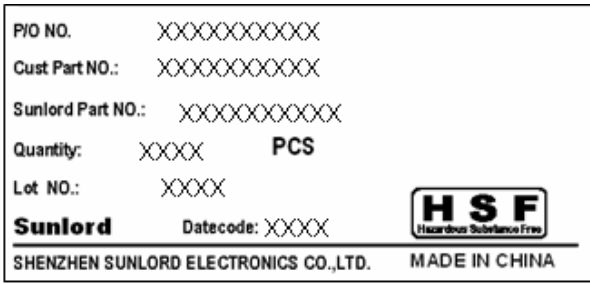

Fig.9.2.3-2A

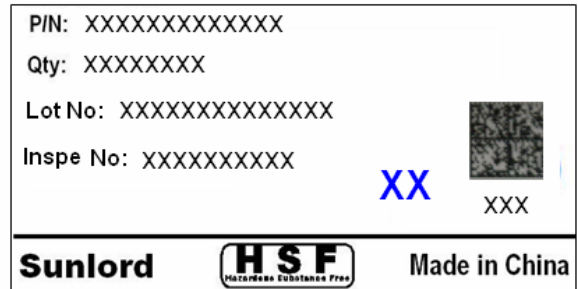

Fig.9.2.3-2B

- 2) Marking label information on inner box
  - a). Inner box please refers to Fig.9.2.3-3 and Table 9.2.3-1
  - b). Marking Label on inner box (see Fig.9.2.3-4)

3) Marking on outer case (see Fig.9.2.3-5~7):

- Out case size please refers to Table 9.2.3-2.
- a). Manufacturer: Sunlord ID:  
"Shenzhen Sunlord Electronics Co., Ltd."
- b). Packing label include the following:
  - i) Customer
  - ii) Manufacturer
  - iii) Date code
  - iv) C/No.

Example; "1/10" means that this case is the 1st one of total 10 cases

- v) P/O No.
- vi) Customer Part No.
- vii) Sunlord Part No.
- viii) Quantity.
- ix) Inspection Stamp.

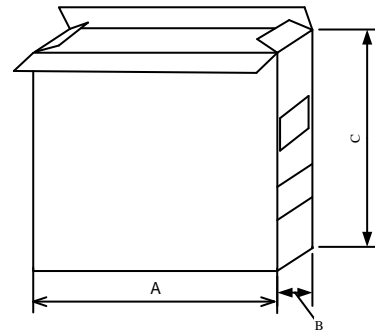

Fig.9.2.3-3

Packaging type	A(mm)	B(mm)	C(mm)
Inner box	180	120	180

[Table 9.2.3-1]

Packaging type	L(mm)	W(mm)	H(mm)
Type1	505	378	200
Type2	380	260	200

[Table 9.2.3-2]

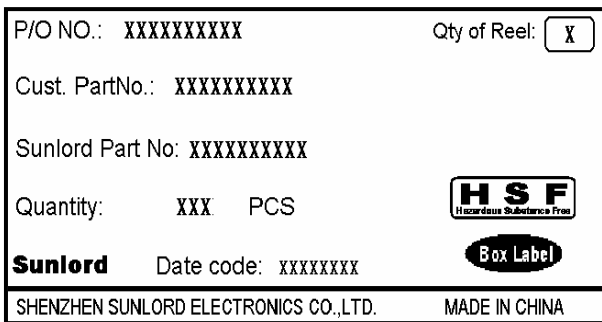

Fig.9.2.3-4

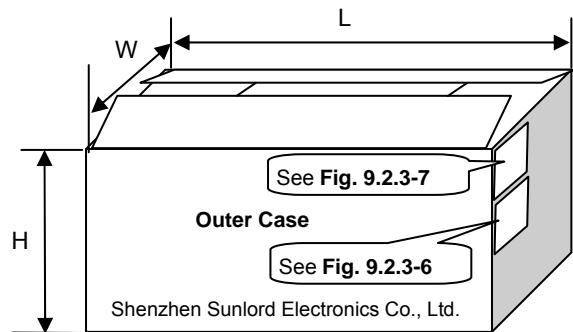

Fig. 9.2.3-5

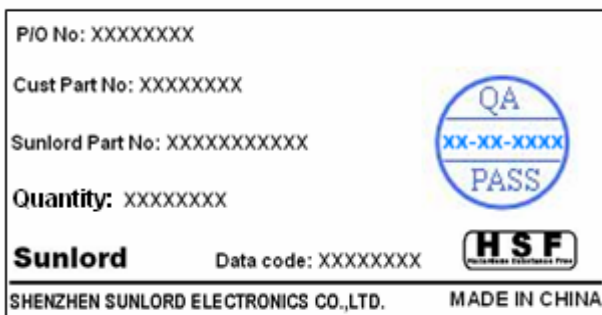

Fig.9.2.3-6

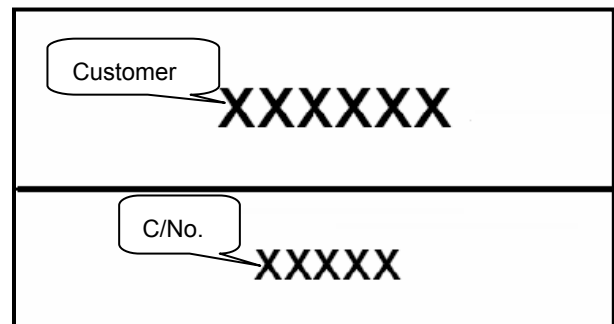

Fig.9.2.3-7

10 Visual inspection standard of product

File No:		Applied to Wire Wound SMD Power Inductor Series		REV:01
Effective date:				
No.	Defect Item	Graphic	Rejection identification	Acceptance
1	Core defect		The defect length/width ( $l$ or $w$ ) more than $L/6$ or $W/6$ , NG.	AQL=0.65
2	Core crack		Visual cracks, NG.	AQL=0.65
3	Starvation		Resin starved length, $l$ , more than $L/2$ , NG. IF $W \geq 2\text{mm}$ , resin starved width, $w$ , more than $W/2$ , NG. IF $W < 2\text{mm}$ , resin starved width, $w$ , don't control.	AQL=0.65
4	Excessive glue		The length, width or height of product beyond specified value, NG.	AQL=0.65
5	Cold solder		For SWPA252012S, cold solders $l$ more than 0.5 mm, NG. For other series, cold solders $l$ more than 1 mm, NG.	AQL=0.65
6	Solder icicle		The height $H$ of product beyond specified value, NG; The clearance $\Delta f$ beyond specified value listed in <b>Item 5</b> , NG;	AQL=0.65
7	Electrode uneven		The clearance $\Delta f$ beyond specified value listed in <b>Item 5</b> , NG;	AQL=0.65



11 Recommended Soldering Technologies

11.1 Re-flowing Profile:

- Preheat condition: 150 ~200 /60~120sec.
- Allowed time above 217 : 60~90sec.
- Max temp: 260
- Max time at max temp: 5sec.
- Solder paste: Sn/3.0Ag/0.5Cu
- Allowed Reflow time: 2x max
- Please refer to Fig. 11.1-1.

[Note: The reflow profile in the above table is only for qualification and is not meant to specify board assembly profiles. Actual board assembly profiles must be based on the customer's specific board design, solder paste and process, and should not exceed the parameters as the Reflow profile shows.]

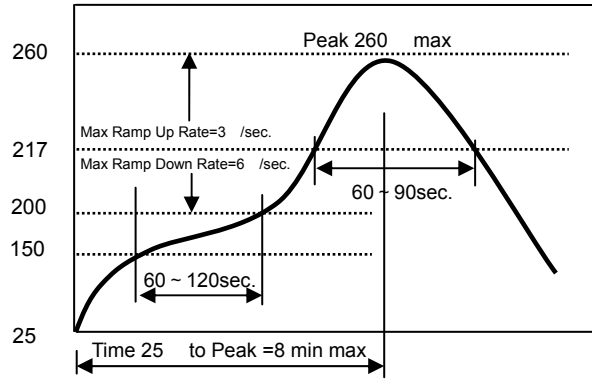

Fig. 11.1-1

11.2 Iron Soldering Profile

- Iron soldering power: Max. 30W
- Pre-heating: 150 /60sec.
- Soldering Tip temperature: 350 Max.
- Soldering time: 3sec. Max.
- Solder paste: Sn/3.0Ag/0.5Cu
- Max.1 times for iron soldering
- Please refer to Fig. 11.2-1.

[Note: Take care not to apply the tip of the soldering iron to the terminal electrodes.]

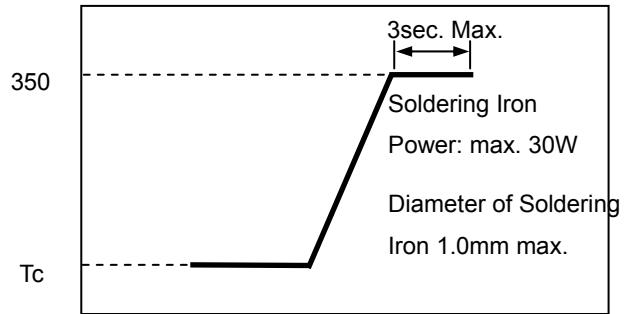

Fig. 11.2-1

12 Electrical Characteristics

Part Number	Inductance	L Tolerance	Inductance Test Condition	DC Resistance (±30%)	Saturation Current	Temperature Rise Current	Min. Self-resonant frequency
Units	µH	-	-	Ω	A	A	MHz
Symbol	L	-	-	DCR	Isat	Irms	SRF
SWPA3010S1R0NT	1.0	±30%	100KHz,1V	0.065	1.40	1.45	180
SWPA3010S1R2NT	1.2	±30%	100KHz,1V	0.065	1.25	1.45	137
SWPA3010S1R5NT	1.5	±30%	100KHz,1V	0.080	1.27	1.30	120
SWPA3010S2R2NT	2.2	±30%	100KHz,1V	0.110	1.15	1.09	100
SWPA3010S2R7NT	2.7	±30%	100KHz,1V	0.130	1.00	1.02	90
SWPA3010S3R3NT	3.3	±30%	100KHz,1V	0.145	0.97	0.96	74
SWPA3010S3R6MT	3.6	±20%	100KHz,1V	0.165	0.95	0.90	67
SWPA3010S4R7MT	4.7	±20%	100KHz,1V	0.225	0.75	0.77	59
SWPA3010S6R8MT	6.8	±20%	100KHz,1V	0.305	0.55	0.66	42
SWPA3010S100MT	10	±20%	100KHz,1V	0.400	0.55	0.58	39
SWPA3010S120MT	12	±20%	100KHz,1V	0.505	0.43	0.52	36
SWPA3010S150MT	15	±20%	100KHz,1V	0.610	0.42	0.47	30
SWPA3010S220MT	22	±20%	100KHz,1V	0.930	0.35	0.38	28
SWPA3010S270MT	27	±20%	100KHz,1V	1.080	0.30	0.35	25
SWPA3010S330MT	33	±20%	100KHz,1V	1.550	0.29	0.30	18
SWPA3010S390MT	39	±20%	100KHz,1V	1.750	0.28	0.28	18
SWPA3010S430MT	43	±20%	100KHz,1V	1.800	0.23	0.27	18
SWPA3010S470MT	47	±20%	100KHz,1V	1.950	0.22	0.26	18
SWPA3010S510MT	51	±20%	100KHz,1V	2.200	0.21	0.25	18
SWPA3010S560MT	56	±20%	100KHz,1V	2.320	0.21	0.24	16

## Typical Electrical Characteristics

Temperature vs. DC Current Characteristics

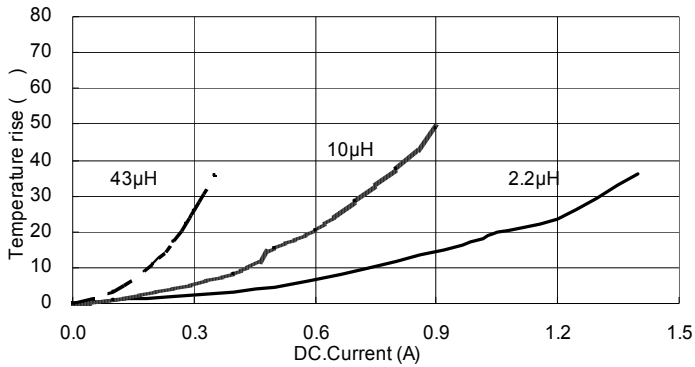

Inductance vs. DC Current Characteristics

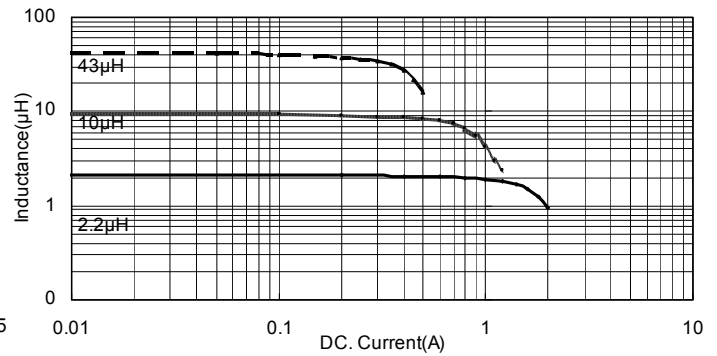

## 13 Precautions

## 13.1 Surface mounting

- Mounting and soldering condition should be checked beforehand.
- Applicable soldering process to this product is reflow soldering only.
- Recommended conditions for repair by soldering iron:  
Preheat the circuit board with product to repair at 150 for about 1 minute.  
Put soldering iron on the land-pattern.  
Soldering iron's temperature: 350 maximum/Duration: 3 seconds maximum/1 time for each terminal.  
The soldering iron should not directly touch the inductor.  
Product once removes from the circuit board may not be used again.

## 13.2 Handling

- Keep the products away from all magnets and magnetic objects.
- Be careful not to subject the products to excessive mechanical shocks.
- Please avoid applying impact to the products after mounted on pc board.
- Avoid ultrasonic cleaning.

## 13.3 Storage

- To maintain the solderability of terminal electrodes and to keep the packing material in good condition, temperature and humidity in the storage area should be controlled.
- Recommended conditions: -10 ~40 , 70%RH (Max.)
- Even under ideal storage conditions, solderability of products electrodes may decrease as time passes. For this reason, product should be used with one year from the time of delivery.
- In case of storage over 12 months, solderability shall be checked before actual usage.

## 13.4 Regarding Regulations

- Any Class- or Class- ozone-depleting substance (ODS) listed in the Clean Air Act in US for regulation is not included in the products or applied to the products at any stage of whose manufacturing processes.
- Certain brominated flame retardants (PBBs, PBDEs) are not used at all.
- The products of this specification are not subject to the Export Trade Control Order in China or the Export Administration Regulations in US.

## 13.5 Guarantee

- The guaranteed operating conditions of the products are in accordance with the conditions specified in this specification.
- Please note that Sunlord takes no responsibility for any failure and/or abnormality which is caused by use under other than the aforesaid operating conditions.

## 14 Supplier Information

## 14.1 Supplier:

Shenzhen Sunlord Electronics Co., Ltd.

## 14.2 Manufacturer:

Shenzhen Sunlord Electronics Co., Ltd.

## 14.3 Manufacturing Address:

Sunlord Industrial Park, Dafuyuan Industrial Zone, Guanlan, Shenzhen, China  
Zip: 518110