

Low-Power Dual Channel Digital Isolators

 Check for Samples: [ISO7420E](#), [ISO7420FE](#), [ISO7421E](#), [ISO7421FE](#)

FEATURES

- Signaling Rate > 50 Mbps
- For Devices with Suffix F, Output is Low in Default Mode
- Low Power Consumption: Typical I_{CC} per Channel (3.3V Supplies):
 - ISO7420: 1.4 mA at 1 Mbps, 2.5 mA at 25 Mbps
 - ISO7421: 1.8 mA at 1 Mbps, 2.8 mA at 25 Mbps
- Low Propagation Delay: 7 ns Typical (E-Grade)
- Low Pulse Skew: 200 ps Typical (E-Grade)
- Wide T_A Range Specified: -40°C to 125°C
- 50 KV/ μs Transient Immunity, Typical
- Isolation Barrier Life: > 25 Years
- Operates from 3V to 5.5V Supply Levels
- Narrow Body SOIC-8 Package

APPLICATIONS

- Opto-Coupler Replacement in:
 - Industrial FieldBus
 - ProfiBus
 - ModBus
 - DeviceNet™ Data Buses
 - Servo Control Interface
 - Motor Control
 - Power Supplies
 - Battery Packs

SAFETY AND REGULATORY APPROVALS

- 3000 V_{RMS} / 4242 V_{PK} Isolation per DIN EN 60747-5-2 (VDE 0884 Part 2)
- 2.5 KV_{RMS} Isolation for 1 minute per UL 1577
- CSA Component Acceptance Notice #5A
- IEC 60950-1 and IEC 61010-1 End Equipment Standards
- All Agencies Approvals Completed

DESCRIPTION

ISO7420x and ISO7421x provide galvanic isolation up to 2500 V_{RMS} for 1 minute per UL and 4242 V_{PK} per VDE. These devices have two isolated channels. Each channel has a logic input and output buffer separated by a silicon dioxide (SiO_2) insulation barrier. Used in conjunction with isolated power supplies, these devices prevent noise currents on a data bus or other circuit from entering the local ground and interfering with or damaging sensitive circuitry. The suffix F indicates low-output option in fail-safe conditions (see [Table 1](#)). E-grade devices have no integrated noise filter and thus have fast propagation delays. CC-grade devices have integrated 10ns-filters for harsh environments where short noise pulses may be present at the device input pins.

These devices have TTL input thresholds and operate from 3V to 5.5V supplies. All inputs are 5V tolerant when supplied from a 3.3V supply.

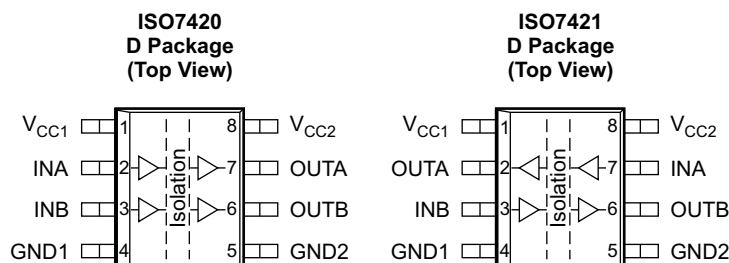

Please be aware that an important notice concerning availability, standard warranty, and use in critical applications of Texas Instruments semiconductor products and disclaimers thereto appears at the end of this data sheet.

DeviceNet is a trademark of Texas Instruments.



These devices have limited built-in ESD protection. The leads should be shorted together or the device placed in conductive foam during storage or handling to prevent electrostatic damage to the MOS gates.

PIN DESCRIPTIONS

NAME	PIN		I/O	DESCRIPTION
	ISO7420x	ISO7421x		
INA	2	7	I	Input, channel A
INB	3	3	I	Input, channel B
GND1	4	4	–	Ground connection for V _{CC1}
GND2	5	5	–	Ground connection for V _{CC2}
OUTA	7	2	O	Output, channel A
OUTB	6	6	O	Output, channel B
V _{CC1}	1	1	–	Power supply, V _{CC1}
V _{CC2}	8	8	–	Power supply, V _{CC2}

Table 1. FUNCTION TABLE⁽¹⁾

INPUT SIDE V _{CC}	OUTPUT SIDE V _{CC}	INPUT INA, INB	OUTPUT OUTA, OUTB	
			ISO7420E / ISO7421E	ISO7420Fx / ISO7421Fx
PU	PU	H	H	H
		L	L	L
		Open	H ⁽²⁾	L ⁽³⁾
PD	PU	X	H ⁽²⁾	L ⁽³⁾
X	PD	X	Undetermined	Undetermined

- (1) PU = Powered up (V_{CC} ≥ 3 V); PD = Powered down (V_{CC} ≤ 2.4 V); X = Irrelevant; H = High level; L = Low level; Z = High Impedance
- (2) In fail-safe condition, output defaults to high level
- (3) In fail-safe condition, output defaults to low level

AVAILABLE OPTIONS

PRODUCT	DATA RATE	DEFAULT OUTPUT	INTEGRATED NOISE FILTER	RATED T _A	CHANNEL DIRECTION	MARKED AS	ORDERING NUMBER	
ISO7420E	50 Mbps	High	No Yes	–40°C to 125°C	Same	SO7420	ISO7420ED (rail)	
ISO7420FE		Low	No		Opposite	I7420F	SO7421	ISO7420FED (rail)
ISO7421E		High					ISO7421ED (rail)	
							ISO7421EDR (reel)	
ISO7421FE		Low					ISO7421FED (rail)	
							ISO7421FEDR (reel)	

ABSOLUTE MAXIMUM RATINGS⁽¹⁾

				VALUE	
V_{CC}	Supply voltage ⁽²⁾ , V_{CC1} , V_{CC2}			-0.5 V to 6 V	
V_I	Voltage at IN, OUT			-0.5 V to 6 V	
I_O	Output current			±15 mA	
ESD	Electrostatic discharge	Human-body model	JEDEC Standard 22, Test Method A114-C.01	All pins	±3 kV
		Field-induced charged-device model	JEDEC Standard 22, Test Method C101		±1.5 kV
		Machine model	ANSI/ESDS5.2-1996		±200 V
$T_{J(Max)}$	Maximum junction temperature			150°C	
T_{stg}	Storage temperature			-65°C to 150°C	

- (1) Stresses beyond those listed under *absolute maximum ratings* may cause permanent damage to the device. These are stress ratings only and functional operation of the device at these or any other conditions beyond those indicated under *recommended operating conditions* is not implied. Exposure to absolute-maximum-rated conditions for extended periods may affect device reliability.
- (2) All voltage values except differential I/O bus voltages are with respect to network ground terminal and are peak voltage values.

RECOMMENDED OPERATING CONDITIONS

		MIN	TYP	MAX	UNIT
V_{CC1} , V_{CC2}	Supply voltage	3.0		5.5	V
I_{OH}	High-level output current	-4			mA
I_{OL}	Low-level output current			4	mA
V_{IH}	High-level input voltage	2		V_{CC}	V
V_{IL}	Low-level input voltage	0		0.8	V
t_{ui}	Input pulse duration	20			ns
$1 / t_{ui}$	Signaling rate	0		50 ⁽¹⁾	Mbps
$T_J^{(2)}$	Junction temperature	-40		136	°C
T_A	Ambient Temperature	-40	25	125	°C

- (1) Under typical conditions, E-grade devices are capable of signaling rate > 150 Mbps.
- (2) To maintain the recommended operating conditions for T_J , see the [Package Thermal Characteristics](#) table.

ELECTRICAL CHARACTERISTICS

V_{CC1} and $V_{CC2} = 5V \pm 10\%$, $T_A = -40^\circ\text{C}$ to 125°C

PARAMETER		TEST CONDITIONS		MIN	TYP	MAX	UNIT
V_{OH}	High-level output voltage	$I_{OH} = -4 \text{ mA}$; see Figure 1 .		$V_{CCx}^{(1)} - 0.8$	4.6		V
		$I_{OH} = -20 \mu\text{A}$; see Figure 1 .		$V_{CCx}^{(1)} - 0.1$	5		
V_{OL}	Low-level output voltage	$I_{OL} = 4 \text{ mA}$; see Figure 1 .			0.2	0.4	V
		$I_{OL} = 20 \mu\text{A}$; see Figure 1 .			0	0.1	
$V_{I(HYS)}$	Input threshold voltage hysteresis				400		mV
I_{IH}	High-level input current	INx at 0 V or V_{CC}				10	μA
I_{IL}	Low-level input current			-10			
CMTI	Common-mode transient immunity	$V_I = V_{CC}$ or 0 V; see Figure 3 .		25	50		kV/ μs
SUPPLY CURRENT (All inputs switching with square wave clock signal for dynamic I_{CC} measurement)							
ISO7420x							
I_{CC1}	Supply current for V_{CC1} and V_{CC2}	DC to 1 Mbps	DC Input: $V_I = V_{CC}$ or 0 V, AC Input: $C_L = 15\text{pF}$		0.4	0.8	mA
I_{CC2}					3.4	5	
I_{CC1}		10 Mbps	$C_L = 15\text{pF}$		0.6	1	
I_{CC2}					4.5	6	
I_{CC1}		25 Mbps	$C_L = 15\text{pF}$		1	1.5	
I_{CC2}					6.2	8	
I_{CC1}		50 Mbps	$C_L = 15\text{pF}$		1.7	2.5	
I_{CC2}					9	12	
ISO7421x							
I_{CC1}	Supply current for V_{CC1} and V_{CC2}	DC to 1 Mbps	DC Input: $V_I = V_{CC}$ or 0 V, AC Input: $C_L = 15\text{pF}$		2.3	3.6	mA
I_{CC2}					2.3	3.6	
I_{CC1}		10 Mbps	$C_L = 15\text{pF}$		2.9	4.5	
I_{CC2}					2.9	4.5	
I_{CC1}		25 Mbps	$C_L = 15\text{pF}$		4.3	6	
I_{CC2}					4.3	6	
I_{CC1}		50 Mbps	$C_L = 15\text{pF}$		6	8.5	
I_{CC2}					6	8.5	

(1) V_{CCx} is the supply voltage for the output channel that is being measured

SWITCHING CHARACTERISTICS

V_{CC1} and $V_{CC2} = 5V \pm 10\%$, $T_A = -40^\circ\text{C}$ to 125°C

PARAMETER		TEST CONDITIONS	MIN	TYP	MAX	UNIT
t_{PLH}, t_{PHL}	Propagation delay time	E-grade		7	11	ns
		CC-grade		17	28	
PWD ⁽¹⁾	Pulse width distortion $ t_{PHL} - t_{PLH} $	ISO7420x		0.2	3	ns
		ISO7421x	See Figure 1 .	0.3	3.7	
$t_{sk(o)}$ ⁽²⁾	Channel-to-channel output skew time	ISO7420x		0.3	1	ns
		ISO7421x		0.3	2	
$t_{sk(pp)}$ ⁽³⁾	Part-to-part skew time	ISO7420x			3.7	ns
		ISO7421x			4.9	
t_r	Output signal rise time	See Figure 1 .		1.8		ns
t_f	Output signal fall time			1.7		ns
t_{fs}	Fail-safe output delay time from input power loss	See Figure 2 .		6		μs

(1) Also known as pulse skew.

(2) $t_{sk(o)}$ is the skew between outputs of a single device with all driving inputs connected together and the outputs switching in the same direction while driving identical loads.

(3) $t_{sk(pp)}$ is the magnitude of the difference in propagation delay times between any terminals of different devices switching in the same direction while operating at identical supply voltages, temperature, input signals and loads.

ELECTRICAL CHARACTERISTICS

 $V_{CC1} = 5V \pm 10\%$, $V_{CC2} = 3.3V \pm 10\%$, $T_A = -40^\circ\text{C}$ to 125°C

PARAMETER		TEST CONDITIONS		MIN	TYP	MAX	UNIT
V_{OH}	High-level output voltage	$I_{OH} = -4\text{ mA}$; see Figure 1 .	ISO7421x (5V side)	$V_{CC1} - 0.8$	4.6		V
			ISO7420x/7421x (3.3V side)	$V_{CC2} - 0.4$	3		
		$I_{OH} = -20\ \mu\text{A}$; see Figure 1 ,	ISO7421x (5V side)	$V_{CC1} - 0.1$	5		
			ISO7420x/7421x (3.3V side)	$V_{CC2} - 0.1$	3.3		
V_{OL}	Low-level output voltage	$I_{OL} = 4\text{ mA}$; see Figure 1 .			0.2	0.4	V
		$I_{OL} = 20\ \mu\text{A}$; see Figure 1 .			0	0.1	
$V_{I(HYS)}$	Input threshold voltage hysteresis				400		mV
I_{IH}	High-level input current	I_{NX} at 0 V or V_{CC}				10	μA
I_{IL}	Low-level input current				-10		μA
CMTI	Common-mode transient immunity	$V_I = V_{CC}$ or 0 V; see Figure 3 .		25	50		kV/ μs
SUPPLY CURRENT (All inputs switching with square wave clock signal for dynamic I_{CC} measurement)							
ISO7420x							
I_{CC1}	Supply current for V_{CC1} and V_{CC2}	DC to 1 Mbps	DC Input: $V_I = V_{CC}$ or 0 V, AC Input: $C_L = 15\text{pF}$		0.4	0.8	mA
I_{CC2}					2.6	3.7	
I_{CC1}		10 Mbps	$C_L = 15\text{pF}$		0.6	1	
I_{CC2}					3.3	4.3	
I_{CC1}		25 Mbps	$C_L = 15\text{pF}$		1	1.5	
I_{CC2}					4.4	5.6	
I_{CC1}		50 Mbps	$C_L = 15\text{pF}$		1.7	2.5	
I_{CC2}					6.2	7.5	
ISO7421x							
I_{CC1}	Supply current for V_{CC1} and V_{CC2}	DC to 1 Mbps	DC Input: $V_I = V_{CC}$ or 0 V, AC Input: $C_L = 15\text{pF}$		2.3	3.6	mA
I_{CC2}					1.8	2.8	
I_{CC1}		10 Mbps	$C_L = 15\text{pF}$		2.9	4.5	
I_{CC2}					2.2	3.2	
I_{CC1}		25 Mbps	$C_L = 15\text{pF}$		4.3	6	
I_{CC2}					2.8	4.1	
I_{CC1}		50 Mbps	$C_L = 15\text{pF}$		6	8.5	
I_{CC2}					3.8	5.5	

SWITCHING CHARACTERISTICS

 $V_{CC1} = 5V \pm 10\%$, $V_{CC2} = 3.3V \pm 10\%$, $T_A = -40^\circ\text{C}$ to 125°C

PARAMETER		TEST CONDITIONS	MIN	TYP	MAX	UNIT
t_{PLH}, t_{PHL}	Propagation delay time	E-grade		8	13.5	ns
		CC-grade		18	32	
PWD ⁽¹⁾	Pulse width distortion $ t_{PHL} - t_{PLH} $	ISO7420x	See Figure 1 .	0.3	3	ns
		ISO7421x		0.5	5.6	
$t_{sk(o)}$ ⁽²⁾	Channel-to-channel output skew time	ISO7420x			1.5	ns
		ISO7421x		0.5	3	
$t_{sk(pp)}$ ⁽³⁾	Part-to-part skew time	ISO7420x			5.4	ns
		ISO7421x			6.3	
t_r	Output signal rise time	See Figure 1 .		2		ns
t_f	Output signal fall time			2		ns
t_{fs}	Fail-safe output delay time from input power loss	See Figure 2 .		6		μs

(1) Also known as pulse skew.

(2) $t_{sk(o)}$ is the skew between outputs of a single device with all driving inputs connected together and the outputs switching in the same direction while driving identical loads.

(3) $t_{sk(pp)}$ is the magnitude of the difference in propagation delay times between any terminals of different devices switching in the same direction while operating at identical supply voltages, temperature, input signals and loads.

ELECTRICAL CHARACTERISTICS

$V_{CC1} = 3.3V \pm 10\%$, $V_{CC2} = 5V \pm 10\%$, $T_A = -40^\circ C$ to $125^\circ C$

PARAMETER		TEST CONDITIONS		MIN	TYP	MAX	UNIT
V_{OH}	High-level output voltage	$I_{OH} = -4$ mA; see Figure 1 .	ISO7421x (3.3V side)	$V_{CC1} - 0.4$	3		V
			ISO7420x/7421x (5V side)	$V_{CC2} - 0.8$	4.6		
		$I_{OH} = -20$ μA ; see Figure 1	ISO7421x (3.3V side)	$V_{CC1} - 0.1$	3.3		
			ISO7420x/7421x (5V side)	$V_{CC2} - 0.1$	5		
V_{OL}	Low-level output voltage	$I_{OL} = 4$ mA; see Figure 1 .			0.2	0.4	V
		$I_{OL} = 20$ μA ; see Figure 1 .			0	0.1	
$V_{I(HYS)}$	Input threshold voltage hysteresis				400		mV
I_{IH}	High-level input current	INx at 0 V or V_{CC}				10	μA
I_{IL}	Low-level input current				-10		μA
CMTI	Common-mode transient immunity	$V_I = V_{CC}$ or 0 V; see Figure 3 .		25	50		kV/ μs
SUPPLY CURRENT (All inputs switching with square wave clock signal for dynamic I_{CC} measurement)							
ISO7420x							
I_{CC1}	Supply current for V_{CC1} and V_{CC2}	DC to 1 Mbps	DC Input: $V_I = V_{CC}$ or 0 V, AC Input: $C_L = 15$ pF		0.2	0.4	mA
I_{CC2}					3.4	5	
I_{CC1}		10 Mbps	$C_L = 15$ pF		0.4	0.6	
I_{CC2}					4.5	6	
I_{CC1}		25 Mbps	$C_L = 15$ pF		0.6	0.9	
I_{CC2}					6.2	8	
I_{CC1}		50 Mbps	$C_L = 15$ pF		1	1.3	
I_{CC2}					9	12	
ISO7421x							
I_{CC1}	Supply current for V_{CC2} and V_{CC2}	DC to 1 Mbps	DC Input: $V_I = V_{CC}$ or 0 V, AC Input: $C_L = 15$ pF		1.8	2.8	mA
I_{CC2}					2.3	3.6	
I_{CC1}		10 Mbps	$C_L = 15$ pF		2.2	3.2	
I_{CC2}					2.9	4.5	
I_{CC1}		25 Mbps	$C_L = 15$ pF		2.8	4.1	
I_{CC2}					4.3	6	
I_{CC1}		50 Mbps	$C_L = 15$ pF		3.8	5.5	
I_{CC2}					6	8.5	

SWITCHING CHARACTERISTICS

$V_{CC1} = 3.3V \pm 10\%$, $V_{CC2} = 5V \pm 10\%$, $T_A = -40^\circ C$ to $125^\circ C$

PARAMETER		TEST CONDITIONS	MIN	TYP	MAX	UNIT
t_{PLH} , t_{PHL}	E-grade	See Figure 1 .		7.5	12	ns
			ISO7420x		7.5	
	ISO7421x			18.5	32	
PWD ⁽¹⁾	Pulse width distortion $ t_{PHL} - t_{PLH} $	See Figure 1 .		0.7	3	ns
			ISO7421x		0.7	
$t_{sk(o)}$ ⁽²⁾	Channel-to-channel output skew time	See Figure 1 .		0.5	1.5	ns
			ISO7421x		0.5	
$t_{sk(pp)}$ ⁽³⁾	Part-to-part skew time	See Figure 1 .			4.6	ns
			ISO7421x			
t_r	Output signal rise time	See Figure 1 .		1.7		ns
t_f	Output signal fall time			1.6		ns
t_{fs}	Fail-safe output delay time from input power loss	See Figure 2 .		6		μs

- (1) Also known as pulse skew.
- (2) $t_{sk(o)}$ is the skew between outputs of a single device with all driving inputs connected together and the outputs switching in the same direction while driving identical loads.
- (3) $t_{sk(pp)}$ is the magnitude of the difference in propagation delay times between any terminals of different devices switching in the same direction while operating at identical supply voltages, temperature, input signals and loads.

ELECTRICAL CHARACTERISTICS

 V_{CC1} and $V_{CC2} = 3.3\text{ V} \pm 10\%$, $T_A = -40^\circ\text{C}$ to 125°C

PARAMETER		TEST CONDITIONS		MIN	TYP	MAX	UNIT
V_{OH}	High-level output voltage	$I_{OH} = -4\text{ mA}$; see Figure 1 .		$V_{CCx}^{(1)} - 0.4$	3		V
		$I_{OH} = -20\ \mu\text{A}$; see Figure 1 .		$V_{CCx}^{(1)} - 0.1$	3.3		
V_{OL}	Low-level output voltage	$I_{OL} = 4\text{ mA}$; see Figure 1 .			0.2	0.4	V
		$I_{OL} = 20\ \mu\text{A}$; see Figure 1 .			0	0.1	
$V_{I(HYS)}$	Input threshold voltage hysteresis				400		mV
I_{IH}	High-level input current	I_{Nx} at 0 V or V_{CC}				10	μA
I_{IL}	Low-level input current				-10		μA
CMTI	Common-mode transient immunity	$V_I = V_{CC}$ or 0 V; see Figure 3 .		25	50		kV/ μs
SUPPLY CURRENT (All inputs switching with square wave clock signal for dynamic I_{CC} measurement)							
ISO7420x							
I_{CC1}	Supply current for V_{CC1} and V_{CC2}	DC to 1 Mbps	DC Input: $V_I = V_{CC}$ or 0 V, AC Input: $C_L = 15\text{pF}$		0.2	0.4	mA
I_{CC2}					2.6	3.7	
I_{CC1}		10 Mbps	$C_L = 15\text{pF}$		0.4	0.6	
I_{CC2}					3.3	4.3	
I_{CC1}		25 Mbps	$C_L = 15\text{pF}$		0.6	0.9	
I_{CC2}					4.4	5.6	
I_{CC1}		50 Mbps	$C_L = 15\text{pF}$		1	1.3	
I_{CC2}					6.2	7.5	
ISO7421x							
I_{CC1}	Supply current for V_{CC1} and V_{CC2}	DC to 1 Mbps	DC Input: $V_I = V_{CC}$ or 0 V, AC Input: $C_L = 15\text{pF}$		1.8	2.8	mA
I_{CC2}					1.8	2.8	
I_{CC1}		10 Mbps	$C_L = 15\text{pF}$		2.2	3.2	
I_{CC2}					2.2	3.2	
I_{CC1}		25 Mbps	$C_L = 15\text{pF}$		2.8	4.1	
I_{CC2}					2.8	4.1	
I_{CC1}		50 Mbps	$C_L = 15\text{pF}$		3.8	5.5	
I_{CC2}					3.8	5.5	

(1) V_{CCx} is the supply voltage for the output channel that is being measured

SWITCHING CHARACTERISTICS

 V_{CC1} and $V_{CC2} = 3.3\text{ V} \pm 10\%$, $T_A = -40^\circ\text{C}$ to 125°C

PARAMETER		TEST CONDITIONS	MIN	TYP	MAX	UNIT
t_{PLH}, t_{PHL}	Propagation delay time	E-grade		8.5	14	ns
		CC-grade	See Figure 1 .	19.5	34	
PWD ⁽¹⁾	Pulse width distortion $ t_{PHL} - t_{PLH} $	ISO7420x and ISO7421x		0.5	2	ns
$t_{sk(o)}$ ⁽²⁾	Channel-to-channel output skew time	ISO7420x		0.4	2	ns
		ISO7421x		0.4	3	
$t_{sk(pp)}$ ⁽³⁾	Part-to-part skew time	ISO7420x			6.2	ns
		ISO7421x			6.8	
t_r	Output signal rise time	See Figure 1 .		2		ns
t_f	Output signal fall time			1.8		ns
t_{fs}	Fail-safe output delay time from input power loss	See Figure 2 .		6		μs

(1) Also known as pulse skew.

(2) $t_{sk(o)}$ is the skew between outputs of a single device with all driving inputs connected together and the outputs switching in the same direction while driving identical loads.

(3) $t_{sk(pp)}$ is the magnitude of the difference in propagation delay times between any terminals of different devices switching in the same direction while operating at identical supply voltages, temperature, input signals and loads.

PARAMETER MEASUREMENT INFORMATION

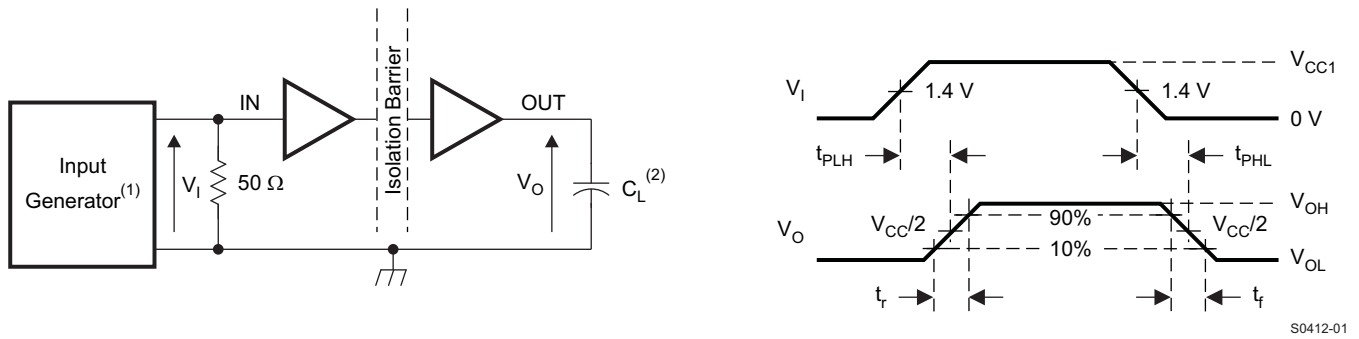

- (1) The input pulse is supplied by a generator having the following characteristics: PRR ≤ 50 kHz, 50% duty cycle, $t_r \leq 3$ ns, $t_f \leq 3$ ns, $Z_o = 50 \Omega$. At the input, a 50- Ω resistor is required to terminate the Input Generator signal. It is not needed in an actual application.
- (2) $C_L = 15$ pF and includes instrumentation and fixture capacitance within $\pm 20\%$.

Figure 1. Switching Characteristic Test Circuit and Voltage Waveforms

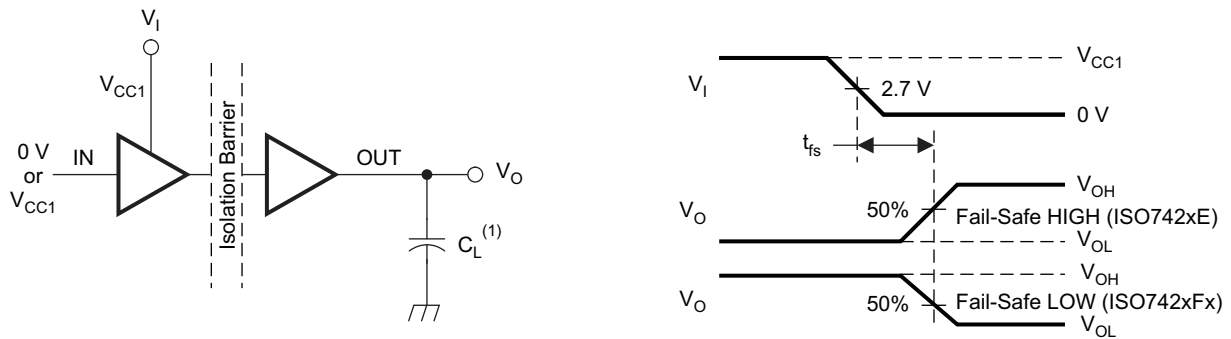

- (1) $C_L = 15$ pF and includes instrumentation and fixture capacitance within $\pm 20\%$.

Figure 2. Fail-Safe Output Delay-Time Test Circuit and Voltage Waveforms

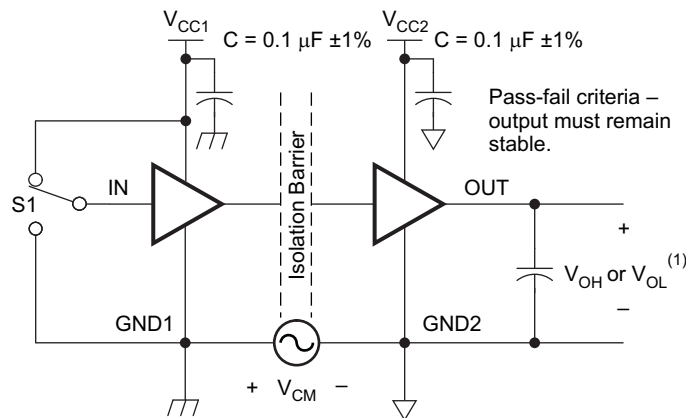

- (1) $C_L = 15$ pF and includes instrumentation and fixture capacitance within $\pm 20\%$.

Figure 3. Common-Mode Transient Immunity Test Circuit

DEVICE INFORMATION

IEC INSULATION AND SAFETY-RELATED SPECIFICATIONS FOR D-8 PACKAGE

over recommended operating conditions (unless otherwise noted)

PARAMETER		TEST CONDITIONS	MIN	TYP	MAX	UNIT
L(I01)	Minimum air gap (clearance)	Shortest terminal-to-terminal distance through air	4.8			mm
L(I02)	Minimum external tracking (creepage)	Shortest terminal-to-terminal distance across the package surface	4.3			mm
CTI	Tracking resistance (comparative tracking index)	DIN IEC 60112 / VDE 0303 Part 1	>400			V
	Minimum internal gap (internal clearance)	Distance through the insulation	0.014			mm
R _{IO}	Isolation resistance, input to output ⁽¹⁾	V _{IO} = 500 V, T _A < 100°C	>10 ¹²			Ω
		V _{IO} = 500 V, 100°C ≤ T _A ≤ max	>10 ¹¹			Ω
C _{IO}	Barrier capacitance, input to output ⁽¹⁾	V _{IO} = 0.4 sin (2πft), f = 1 MHz		1		pF
C _I	Input capacitance ⁽²⁾	V _I = V _{CC} /2 + 0.4 sin (2πft), f = 1 MHz, V _{CC} = 5 V		1		pF

(1) All pins on each side of the barrier tied together creating a two-terminal device.

(2) Measured from input pin to ground.

NOTE

Creepage and clearance requirements should be applied according to the specific equipment isolation standards of an application. Care should be taken to maintain the creepage and clearance distance of a board design to ensure that the mounting pads of the isolator on the printed-circuit board do not reduce this distance.

Creepage and clearance on a printed-circuit board become equal in certain cases. Techniques such as inserting grooves and/or ribs on a printed circuit board are used to help increase these specifications.

INSULATION CHARACTERISTICS

over recommended operating conditions (unless otherwise noted)

PARAMETER ⁽¹⁾		TEST CONDITIONS	SPECIFICATION	UNIT
V _{IORM}	Maximum working insulation voltage ⁽²⁾		566	V _{PEAK}
V _{PR}	Input-to-output test voltage per IEC 60747-5-2	Method a, After environmental tests subgroup 1, V _{PR} = V _{IORM} × 1.6, t = 10 s, Partial Discharge < 5 pC	906	V _{PEAK}
		Method b1, V _{PR} = V _{IORM} × 1.875, t = 1 s (100% Production test) Partial discharge < 5 pC	1062	
		After Input/Output safety test subgroup 2/3, V _{PR} = V _{IORM} × 1.2, t = 10 s, Partial discharge < 5 pC	680	
V _{IOTM}	Transient overvoltage per IEC 60747-5-2	V _{TEST} = V _{IOTM} t = 60 sec (qualification) t = 1 sec (100% production)	4242	V _{PEAK}
V _{IOSM}	Maximum surge voltage	Tested per IEC 60065 (Qualification Test)	4000	V _{PEAK}
V _{ISO}	Isolation voltage per UL	V _{TEST} = V _{ISO} , t = 60 sec (qualification)	2500	V _{RMS}
		V _{TEST} = 1.2 × V _{ISO} , t = 1 sec (100% production)	3000	
R _S	Insulation resistance	V _{IO} = 500 V at T _S	>10 ⁹	Ω
	Pollution degree		2	

(1) Climatic Classification 40/125/21

(2) For applications that require DC working voltages between GND1 and GND2, contact Texas Instruments for further details.

Table 2. IEC 60664-1 RATINGS TABLE

PARAMETER	TEST CONDITIONS	SPECIFICATION
Basic isolation group	Material group	II
Installation classification	Rated mains voltage $\leq 150 V_{RMS}$	I–IV
	Rated mains voltage $\leq 300 V_{RMS}$	I–III
	Rated mains voltage $\leq 400 V_{RMS}$	I–II

REGULATORY INFORMATION

VDE	CSA	UL
Certified according to DIN EN 60747-5-2 (VDE 0884 Part 2)	Approved under CSA Component Acceptance Notice #5A	Recognized under UL 1577 Component Recognition Program
Basic Insulation Maximum Transient Overvoltage, 4242 V_{PK} Maximum Surge Voltage, 4000 V_{PK} Maximum Working Voltage, 566 V_{PK}	Basic insulation per CSA 60950-1-07 and IEC 60950-1 (2nd Ed), 390 V_{RMS} maximum working voltage	Single / Basic Isolation Voltage, 2500 V_{RMS} ⁽¹⁾
File number: 40016131	File number: 220991	File number: E181974

(1) Production tested $\geq 3000 V_{RMS}$ for 1 second in accordance with UL 1577.

LIFE EXPECTANCY vs WORKING VOLTAGE

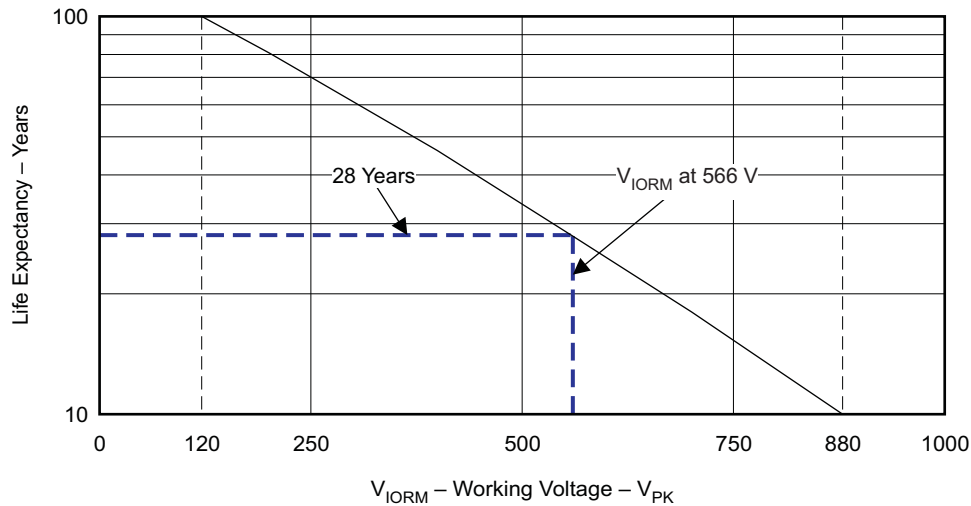

Figure 4. Life Expectancy vs Working Voltage

G001

IEC SAFETY LIMITING VALUES

Safety limiting intends to prevent potential damage to the isolation barrier upon failure of input or output circuitry. A failure of the I/O can allow low resistance to ground or the supply and, without current limiting, dissipate sufficient power to overheat the die and damage the isolation barrier, potentially leading to secondary system failures.

PARAMETER		TEST CONDITIONS	MIN	TYP	MAX	UNIT
I _S	Safety input, output, or supply current	$\theta_{JA} = 212^{\circ}\text{C/W}$, $V_I = 5.5\text{ V}$, $T_J = 150^{\circ}\text{C}$, $T_A = 25^{\circ}\text{C}$			107	mA
		$\theta_{JA} = 212^{\circ}\text{C/W}$, $V_I = 3.6\text{ V}$, $T_J = 150^{\circ}\text{C}$, $T_A = 25^{\circ}\text{C}$			164	
T _S	Maximum case temperature				150	°C

The safety-limiting constraint is the absolute-maximum junction temperature specified in the *Absolute Maximum Ratings* table. The power dissipation and junction-to-air thermal impedance of the device installed in the application hardware determines the junction temperature. The assumed junction-to-air thermal resistance in the *Thermal Characteristics* table is that of a device installed in the JESD51-3, Low-Effective-Thermal-Conductivity Test Board for Leaded Surface-Mount Packages and is conservative. The power is the recommended maximum input voltage times the current. The junction temperature is then the ambient temperature plus the power times the junction-to-air thermal resistance.

PACKAGE THERMAL CHARACTERISTICS

(over recommended operating conditions unless otherwise noted)

PARAMETER		TEST CONDITIONS	MIN	TYP	MAX	UNIT
θ_{JA}	Junction-to-air thermal resistance	Low-K thermal resistance ⁽¹⁾		212		°C/W
		High-K thermal resistance ⁽¹⁾		122		
θ_{JB}	Junction-to-board thermal resistance			37		°C/W
θ_{JC}	Junction-to-case thermal resistance			69.1		°C/W
P _D	Device power dissipation	$V_{CC1} = V_{CC2} = 5.5\text{ V}$, $T_J = 150^{\circ}\text{C}$, $C_L = 15\text{ pF}$, Input a 100-Mbps 50% duty-cycle square wave			138	mW

(1) Tested in accordance with the low-K or high-K thermal metric definitions of EIA/JESD51-3 for leaded surface-mount packages

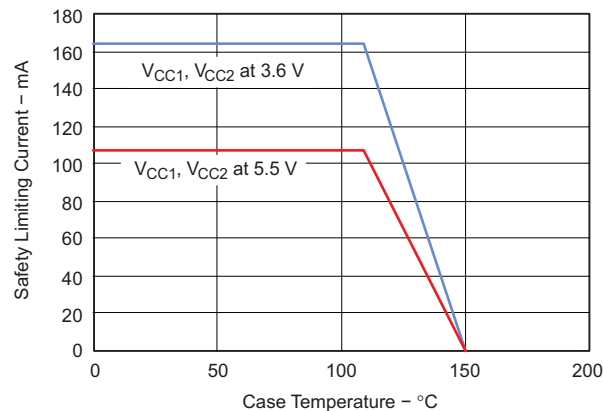

Figure 5. θ_{JC} Thermal Derating Curve per IEC 60747-5-2

APPLICATION INFORMATION

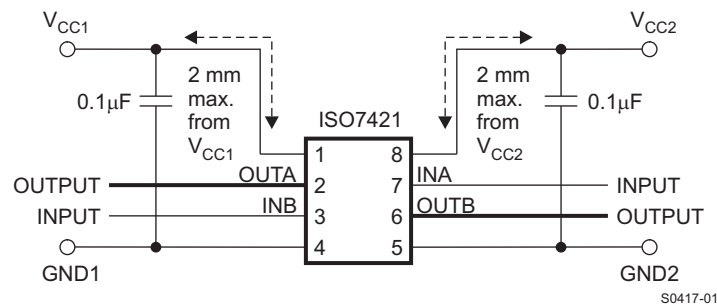

Figure 6. Typical ISO7421x Application Circuit

Note: For detailed layout recommendations, see Application Note [SLLA284](#), *Digital Isolator Design Guide*.

SUPPLY CURRENT EQUATIONS

Maximum Supply Current Equations:

(Calculated over recommended operating temperature range and Silicon process variation)

ISO7420

At $V_{CC1} = V_{CC2} = 3.3V \pm 10\%$

$$I_{CC1}(\max) = I_{CC1_Q}(\max) + 1.791 \times 10^{-2} \times f \quad (1)$$

$$I_{CC2}(\max) = I_{CC2_Q}(\max) + 1.687 \times 10^{-2} \times f + 3.570 \times 10^{-3} \times f \times C_L \quad (2)$$

At $V_{CC1} = V_{CC2} = 5V \pm 10\%$

$$I_{CC1}(\max) = I_{CC1_Q}(\max) + 3.152 \times 10^{-2} \times f \quad (3)$$

$$I_{CC2}(\max) = I_{CC2_Q}(\max) + 2.709 \times 10^{-2} \times f + 5.365 \times 10^{-3} \times f \times C_L \quad (4)$$

ISO7421

At $V_{CC1} = V_{CC2} = 3.3V \pm 10\%$

$$I_{CC1}(\max) = I_{CC1_Q}(\max) + 1.726 \times 10^{-2} \times f + 1.785 \times 10^{-3} \times f \times C_L \quad (5)$$

$$I_{CC2}(\max) = I_{CC2_Q}(\max) + 1.726 \times 10^{-2} \times f + 1.785 \times 10^{-3} \times f \times C_L \quad (6)$$

At $V_{CC1} = V_{CC2} = 5V \pm 10\%$

$$I_{CC1}(\max) = I_{CC1_Q}(\max) + 2.920 \times 10^{-2} \times f + 2.682 \times 10^{-3} \times f \times C_L \quad (7)$$

$$I_{CC2}(\max) = I_{CC2_Q}(\max) + 2.920 \times 10^{-2} \times f + 2.682 \times 10^{-3} \times f \times C_L \quad (8)$$

$I_{CC1_Q}(\max)$ and $I_{CC2_Q}(\max)$ are equivalent to the maximum supply currents measured in mA under DC input conditions (provided in the specification tables of this data sheet); f is data rate in Mbps of both channels; C_L is the capacitive load in pF of both channels. $I_{CC1}(\max)$ and $I_{CC2}(\max)$ are measured in mA.

Typical Supply Current Equations:

(Calculated over recommended operating temperature range and Silicon process variation)

ISO7420

At $V_{CC1} = V_{CC2} = 3.3V$

$$I_{CC1}(\text{typ}) = I_{CC1_Q}(\text{typ}) + 1.528 \times 10^{-2} \times f \quad (9)$$

$$I_{CC2}(\text{typ}) = I_{CC2_Q}(\text{typ}) + 1.637 \times 10^{-2} \times f + 3.275 \times 10^{-3} \times f \times C_L \quad (10)$$

At $V_{CC1} = V_{CC2} = 5V$

$$I_{CC1}(\text{typ}) = I_{CC1_Q}(\text{typ}) + 2.640 \times 10^{-2} \times f \quad (11)$$

$$I_{CC2}(\text{typ}) = I_{CC2_Q}(\text{typ}) + 2.502 \times 10^{-2} \times f + 4.919 \times 10^{-3} \times f \times C_L \quad (12)$$

ISO7421

At $V_{CC1} = V_{CC2} = 3.3V$

$$I_{CC1}(typ) = I_{CC1_Q}(typ) + 1.567 \times 10^{-2} \times f + 1.640 \times 10^{-3} \times f \times C_L \quad (13)$$

$$I_{CC2}(typ) = I_{CC2_Q}(typ) + 1.567 \times 10^{-2} \times f + 1.640 \times 10^{-3} \times f \times C_L \quad (14)$$

At $V_{CC1} = V_{CC2} = 5V$

$$I_{CC1}(typ) = I_{CC1_Q}(typ) + 2.550 \times 10^{-2} \times f + 2.416 \times 10^{-3} \times f \times C_L \quad (15)$$

$$I_{CC2}(typ) = I_{CC2_Q}(typ) + 2.550 \times 10^{-2} \times f + 2.461 \times 10^{-3} \times f \times C_L \quad (16)$$

$I_{CC1_Q}(typ)$ and $I_{CC2_Q}(typ)$ are equivalent to the typical supply currents measured in mA under DC input conditions (provided in the specification tables of this data sheet); f is data rate in Mbps of each channel; C_L is the capacitive load in pF of each channel. $I_{CC1}(typ)$ and $I_{CC2}(typ)$ are measured in mA.

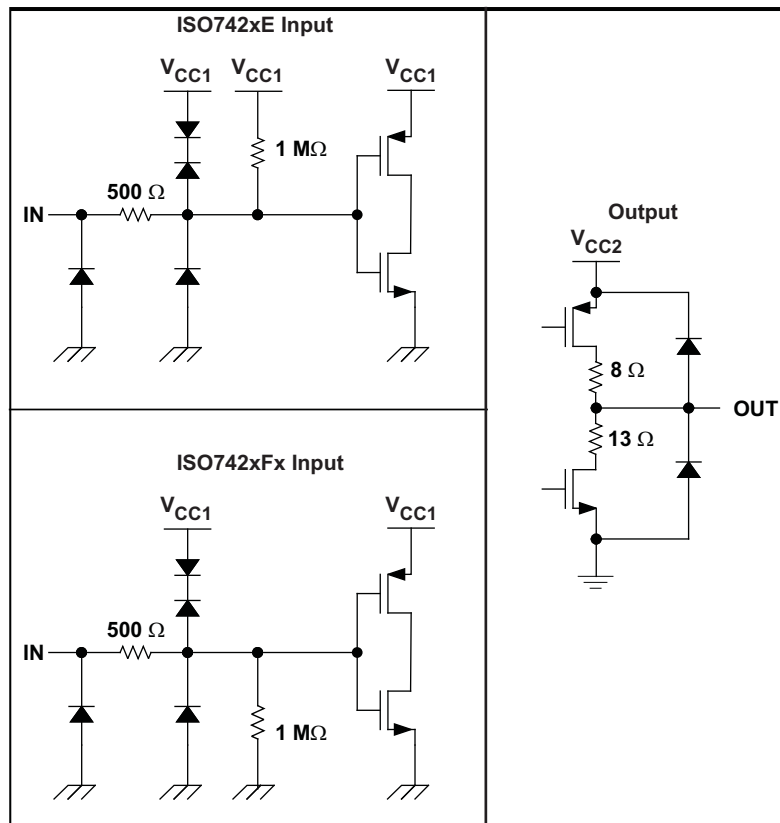

Figure 7. Device I/O Schematics

TYPICAL CHARACTERISTICS

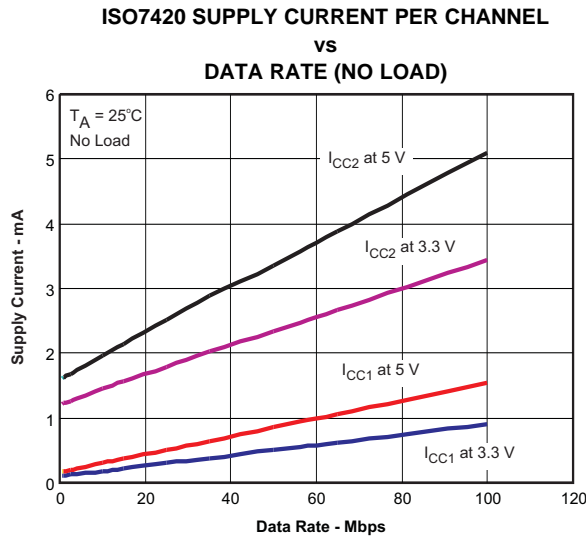

Figure 8.

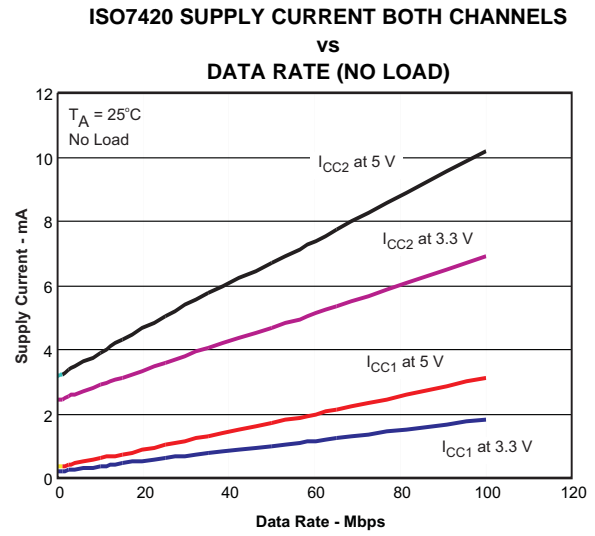

Figure 9.

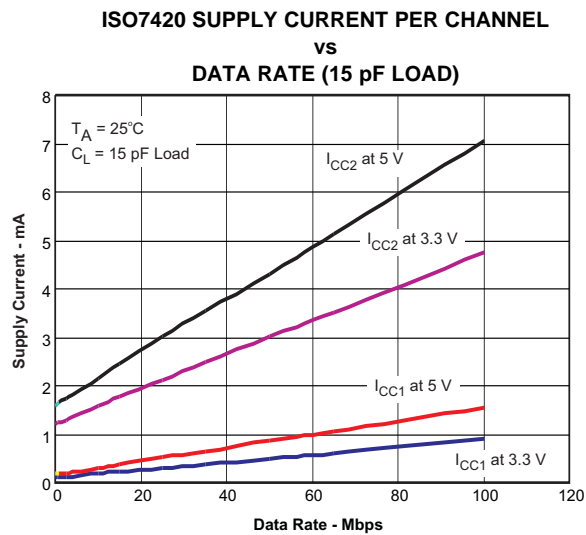

Figure 10.

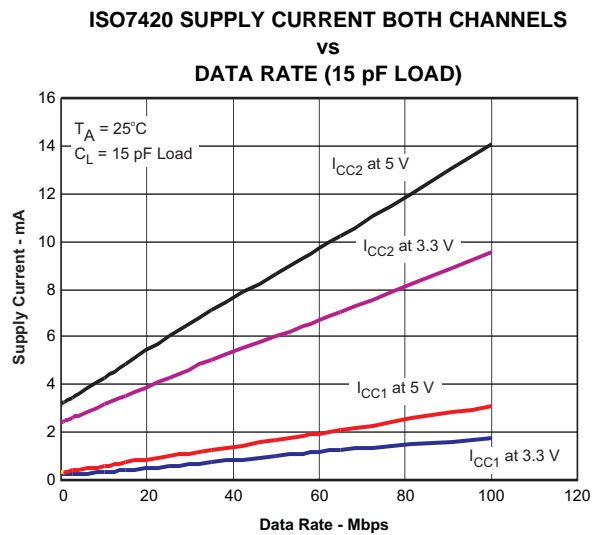

Figure 11.

TYPICAL CHARACTERISTICS (continued)

**ISO7421 SUPPLY CURRENT PER CHANNEL
vs
DATA RATE (NO LOAD)**

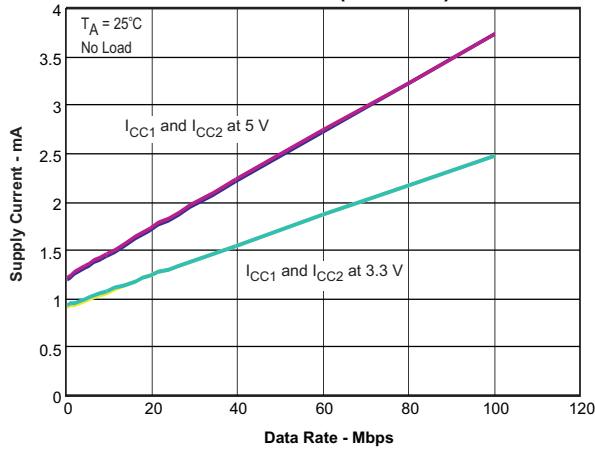

Figure 12.

**ISO7421 SUPPLY CURRENT BOTH CHANNELS
vs
DATA RATE (NO LOAD)**

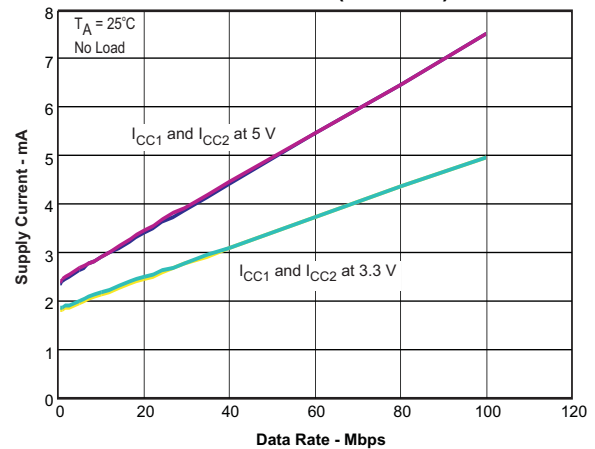

Figure 13.

**ISO7421 SUPPLY CURRENT PER CHANNEL
vs
DATA RATE (15 pF LOAD)**

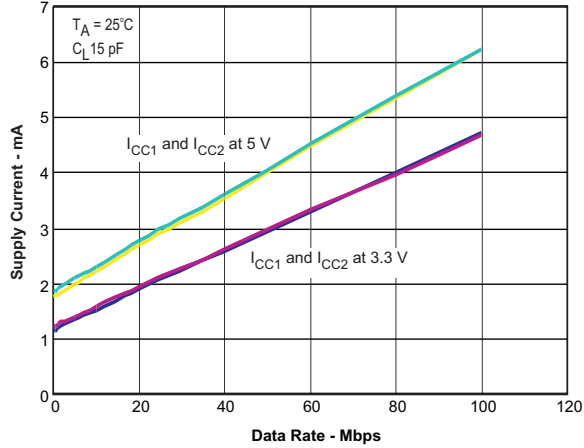

Figure 14.

**ISO7421 SUPPLY CURRENT BOTH CHANNELS
vs
DATA RATE (15 pF LOAD)**

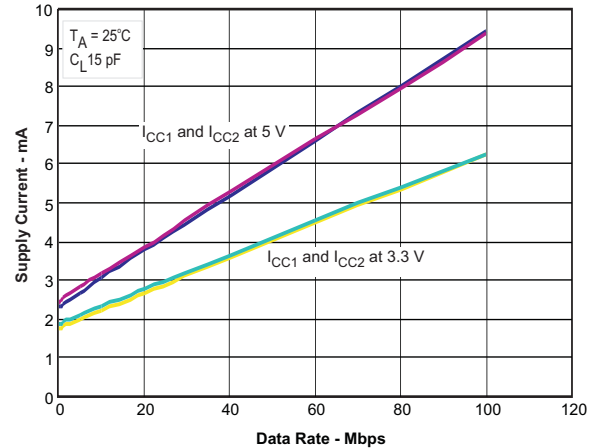

Figure 15.

TYPICAL CHARACTERISTICS (continued)

**'E-GRADE PROPAGATION DELAY TIME
vs
FREE-AIR TEMPERATURE**

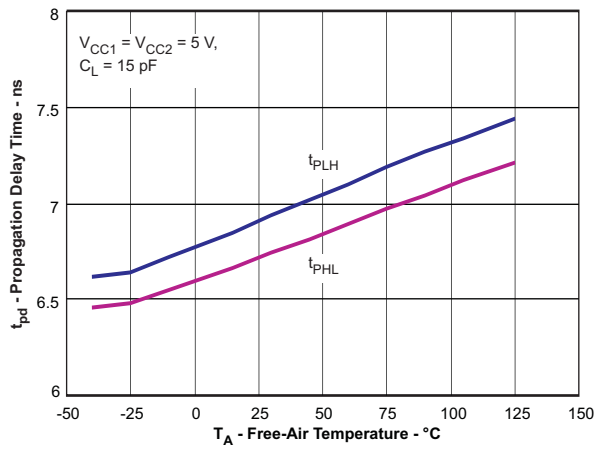

Figure 16.

**'E-GRADE PROPAGATION DELAY TIME
vs
FREE-AIR TEMPERATURE**

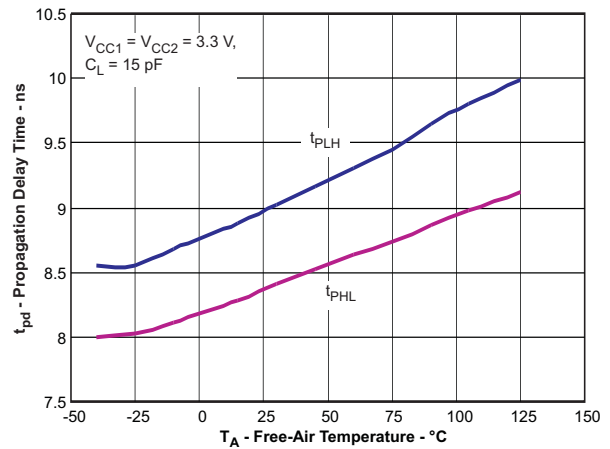

Figure 17.

**INPUT V_{CC} FAIL-SAFE VOLTAGE THRESHOLD
vs
FREE-AIR TEMPERATURE**

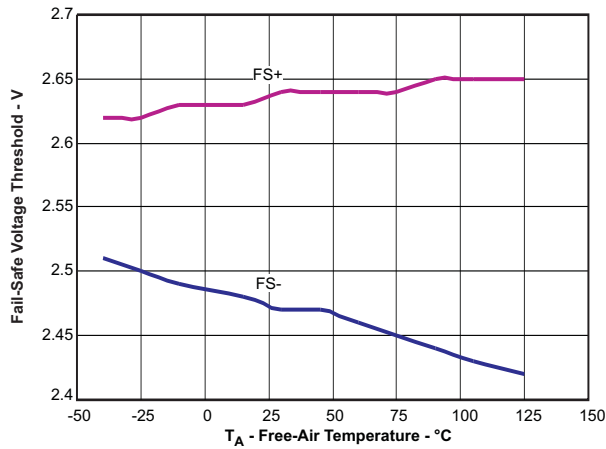

Figure 18.

**HIGH-LEVEL OUTPUT VOLTAGE
vs
HIGH-LEVEL OUTPUT CURRENT**

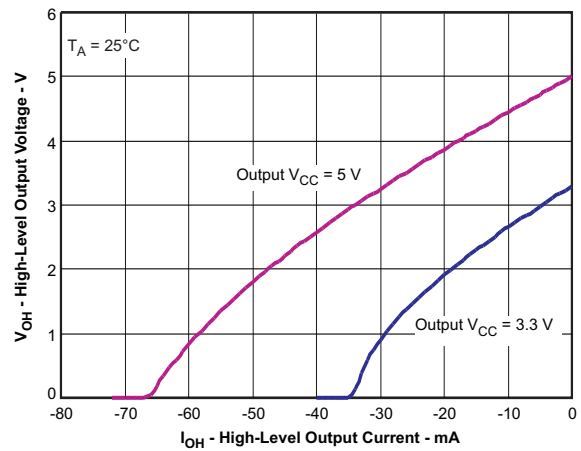

Figure 19.

TYPICAL CHARACTERISTICS (continued)

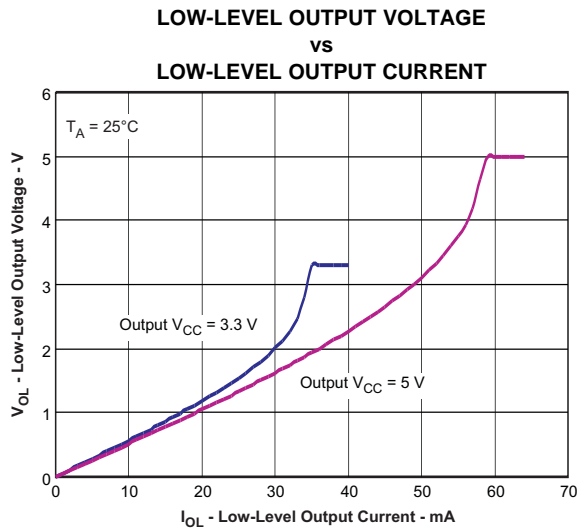

Figure 20.

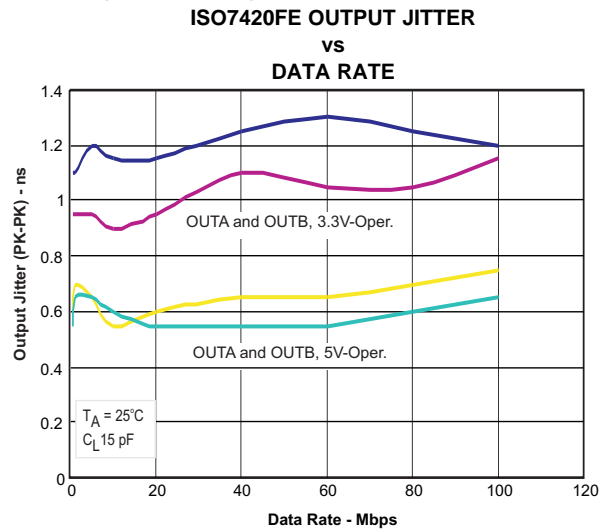

Figure 21.

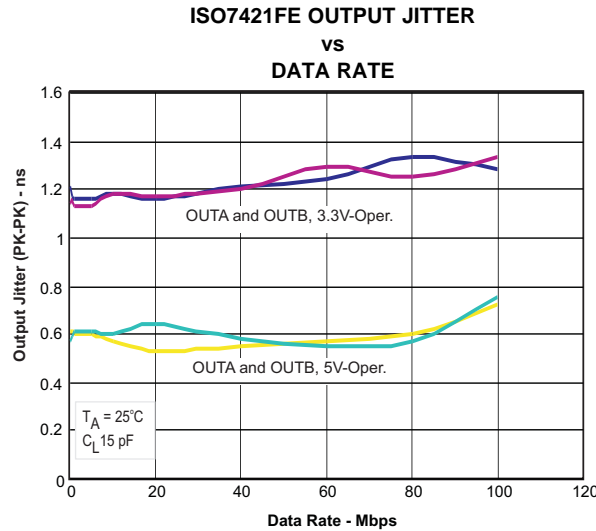

Figure 22.

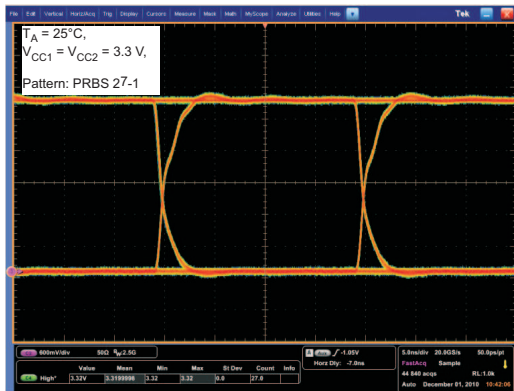

Figure 23. ISO7420FE Typical Eye Diagram at 50 MBPS, 3.3 V Operation

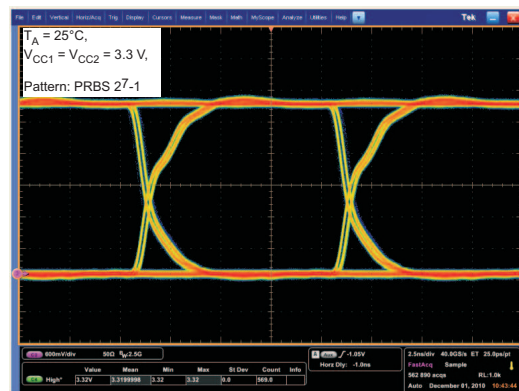

Figure 24. ISO7420FE Typical Eye Diagram at 100 MBPS, 3.3 V Operation

REVISION HISTORY

Changes from Original (December 2010) to Revision A	Page
<ul style="list-style-type: none"> Changed the Max values for Supply current for V_{CC1} and V_{CC2}, $C_L = 15\text{pF}$ 	7

Changes from Revision A (December 2010) to Revision B	Page
<ul style="list-style-type: none"> Changed Feature bullet From: ISO7421: TBDmA at 1Mbps, TBDmA at 25Mbps To: ISO7421: 1.8mA at 1Mbps, 2.8mA at 25Mbps Updated the ISO7421x Supply Current values for V_{CC1} and $V_{CC2} = 5\text{V}$ Updated the ISO7421x Supply Current values for $V_{CC1} = 5\text{V}$ and $V_{CC2} = 3.3\text{V}$ Updated the ISO7421x Supply Current values for $V_{CC1} = 3.3\text{V}$ and $V_{CC2} = 5\text{V}$ Updated the ISO7421x Supply Current values for V_{CC1} and $V_{CC2} = 3.3\text{V}$ 	1 4 5 6 7

Changes from Revision B (January 2011) to Revision C	Page
<ul style="list-style-type: none"> Added devices ISO7420FCC and ISO7421FCC Changed Feature bullet To: Low Propagation Delay: 7 ns Typical (E-Grade) Changed Feature bullet To: Low Pulse Skew: 200 Typical (E-Grade) Changed the SAFETY and REGULATORY APPROVALS list Changed the data sheet DESCRIPTION Changed PU to X in the last row of the FUNCTION TABLE Changed the Available Options Table Changed the Supply Current values for ISO7421x at 10, 25, and 50 Mbps Added CC-grade and valued to t_{PLH}, t_{PHL} in the Switching Characteristics table Added ISO7421x values for Pulse width distortion, Channel-to-channel output skew time, and Part-to-part skew time Changed the Supply Current values for ISO7421x at 10, 25, and 50 Mbps Added CC-grade and valued to t_{PLH}, t_{PHL} in the Switching Characteristics table Added ISO7421x values for Pulse width distortion and Channel-to-channel output skew time Changed the Supply Current values for ISO7421x at 10, 25, and 50 Mbps Added CC-grade and valued to t_{PLH}, t_{PHL} in the Switching Characteristics table Changed the Supply Current values for ISO7421x 25 and 50 Mbps Added CC-grade and valued to t_{PLH}, t_{PHL} in the Switching Characteristics table Changed Note 1 Figure 1 Changed Figure 2 Changed Isolation resistance test conditions Changed the values of V_{IORM} and V_{PR} in the INSULATION CHARACTERISTICS table Changed the value of V_{IOTM} in the INSULATION CHARACTERISTICS table From: 4000 To: 4242 Changed Figure 5 Added section: SUPPLY CURRENT EQUATIONS Added graphs Figure 12, Figure 13, Figure 14, and Figure 15 Added graphs Figure 21 and Figure 22 	1 1 1 1 1 2 2 4 4 4 5 5 5 6 6 7 7 8 8 9 9 9 11 12 14 16

Changes from Revision C (March 2011) to Revision D
Page

• Changed SAFETY feature Bullet From: UL 1577 Approved; Other Approvals Pending To: All Agencies Approvals Completed	1
• Changed the value of VOISM in the INSULATION CHARACTERISTICS table From: 4242 To: 4000	9
• Changed the REGULATORY INFORMATION table	10

Changes from Revision D (December 2011) to Revision E
Page

• Deleted devices ISO7420FCC and ISO7421FCC	1
• Changed Z to Undetermined for the OUTPUT OUTA, OUTB column of the FUNCTION TABLE	2
• Changed the NOTE: text	9
• Added table Note to V_{IORM}	9

PACKAGING INFORMATION

Orderable Device	Status (1)	Package Type	Package Drawing	Pins	Package Qty	Eco Plan (2)	Lead/Ball Finish	MSL Peak Temp (3)	Op Temp (°C)	Top-Side Markings (4)	Samples
ISO7420ED	ACTIVE	SOIC	D	8	75	Green (RoHS & no Sb/Br)	CU NIPDAU	Level-1-260C-UNLIM	-40 to 125	SO7420	Samples
ISO7420EDR	ACTIVE	SOIC	D	8	2500	Green (RoHS & no Sb/Br)	CU NIPDAU	Level-1-260C-UNLIM	-40 to 125	SO7420	Samples
ISO7420FED	ACTIVE	SOIC	D	8	75	Green (RoHS & no Sb/Br)	CU NIPDAU	Level-1-260C-UNLIM	-40 to 125	I7420F	Samples
ISO7420FEDR	ACTIVE	SOIC	D	8	2500	Green (RoHS & no Sb/Br)	CU NIPDAU	Level-1-260C-UNLIM	-40 to 125	I7420F	Samples
ISO7421ED	ACTIVE	SOIC	D	8	75	Green (RoHS & no Sb/Br)	CU NIPDAU	Level-1-260C-UNLIM	-40 to 125	SO7421	Samples
ISO7421EDR	ACTIVE	SOIC	D	8	2500	Green (RoHS & no Sb/Br)	CU NIPDAU	Level-1-260C-UNLIM	-40 to 125	SO7421	Samples
ISO7421FED	ACTIVE	SOIC	D	8	75	Green (RoHS & no Sb/Br)	CU NIPDAU	Level-1-260C-UNLIM	-40 to 125	I7421F	Samples
ISO7421FEDR	ACTIVE	SOIC	D	8	2500	Green (RoHS & no Sb/Br)	CU NIPDAU	Level-1-260C-UNLIM	-40 to 125	I7421F	Samples

(1) The marketing status values are defined as follows:

ACTIVE: Product device recommended for new designs.

LIFEBUY: TI has announced that the device will be discontinued, and a lifetime-buy period is in effect.

NRND: Not recommended for new designs. Device is in production to support existing customers, but TI does not recommend using this part in a new design.

PREVIEW: Device has been announced but is not in production. Samples may or may not be available.

OBSELETE: TI has discontinued the production of the device.

(2) Eco Plan - The planned eco-friendly classification: Pb-Free (RoHS), Pb-Free (RoHS Exempt), or Green (RoHS & no Sb/Br) - please check <http://www.ti.com/productcontent> for the latest availability information and additional product content details.

TBD: The Pb-Free/Green conversion plan has not been defined.

Pb-Free (RoHS): TI's terms "Lead-Free" or "Pb-Free" mean semiconductor products that are compatible with the current RoHS requirements for all 6 substances, including the requirement that lead not exceed 0.1% by weight in homogeneous materials. Where designed to be soldered at high temperatures, TI Pb-Free products are suitable for use in specified lead-free processes.

Pb-Free (RoHS Exempt): This component has a RoHS exemption for either 1) lead-based flip-chip solder bumps used between the die and package, or 2) lead-based die adhesive used between the die and leadframe. The component is otherwise considered Pb-Free (RoHS compatible) as defined above.

Green (RoHS & no Sb/Br): TI defines "Green" to mean Pb-Free (RoHS compatible), and free of Bromine (Br) and Antimony (Sb) based flame retardants (Br or Sb do not exceed 0.1% by weight in homogeneous material)

(3) MSL, Peak Temp. -- The Moisture Sensitivity Level rating according to the JEDEC industry standard classifications, and peak solder temperature.

⁽⁴⁾ Multiple Top-Side Markings will be inside parentheses. Only one Top-Side Marking contained in parentheses and separated by a "~" will appear on a device. If a line is indented then it is a continuation of the previous line and the two combined represent the entire Top-Side Marking for that device.

Important Information and Disclaimer: The information provided on this page represents TI's knowledge and belief as of the date that it is provided. TI bases its knowledge and belief on information provided by third parties, and makes no representation or warranty as to the accuracy of such information. Efforts are underway to better integrate information from third parties. TI has taken and continues to take reasonable steps to provide representative and accurate information but may not have conducted destructive testing or chemical analysis on incoming materials and chemicals. TI and TI suppliers consider certain information to be proprietary, and thus CAS numbers and other limited information may not be available for release.

In no event shall TI's liability arising out of such information exceed the total purchase price of the TI part(s) at issue in this document sold by TI to Customer on an annual basis.

OTHER QUALIFIED VERSIONS OF ISO7421E :

- Automotive: [ISO7421E-Q1](#)

NOTE: Qualified Version Definitions:

- Automotive - Q100 devices qualified for high-reliability automotive applications targeting zero defects

TAPE AND REEL INFORMATION

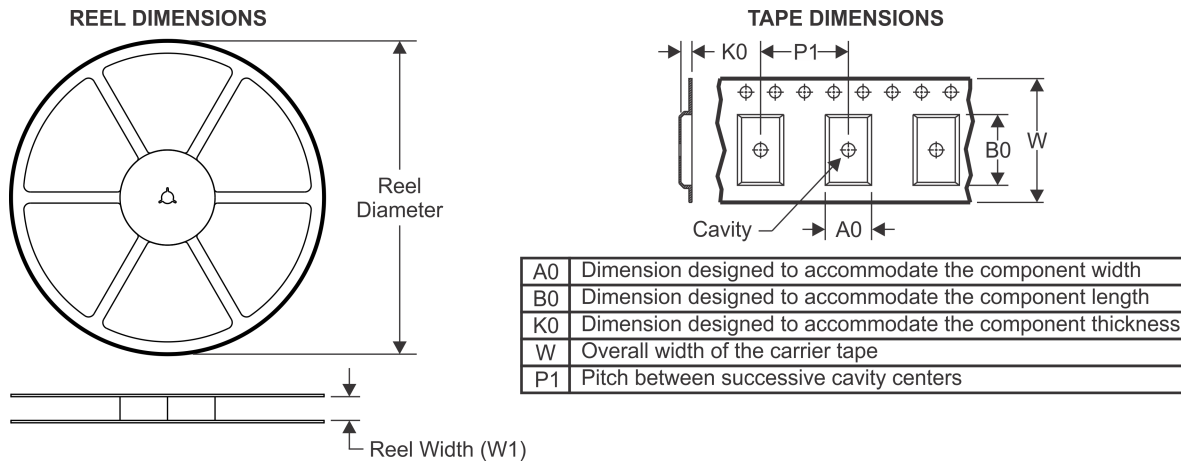

QUADRANT ASSIGNMENTS FOR PIN 1 ORIENTATION IN TAPE



*All dimensions are nominal

Device	Package Type	Package Drawing	Pins	SPQ	Reel Diameter (mm)	Reel Width W1 (mm)	A0 (mm)	B0 (mm)	K0 (mm)	P1 (mm)	W (mm)	Pin1 Quadrant
ISO7420EDR	SOIC	D	8	2500	330.0	12.4	6.4	5.2	2.1	8.0	12.0	Q1
ISO7421FEDR	SOIC	D	8	2500	330.0	12.4	6.4	5.2	2.1	8.0	12.0	Q1

TAPE AND REEL BOX DIMENSIONS

*All dimensions are nominal

Device	Package Type	Package Drawing	Pins	SPQ	Length (mm)	Width (mm)	Height (mm)
ISO7420EDR	SOIC	D	8	2500	367.0	367.0	35.0
ISO7421FEDR	SOIC	D	8	2500	367.0	367.0	35.0

D (R-PDSO-G8)

PLASTIC SMALL OUTLINE



NOTES: A. All linear dimensions are in inches (millimeters).
 B. This drawing is subject to change without notice.
 C. Body length does not include mold flash, protrusions, or gate burrs. Mold flash, protrusions, or gate burrs shall not exceed 0.006 (0,15) each side.
 D. Body width does not include interlead flash. Interlead flash shall not exceed 0.017 (0,43) each side.
 E. Reference JEDEC MS-012 variation AA.

D (R-PDSO-G8)

PLASTIC SMALL OUTLINE

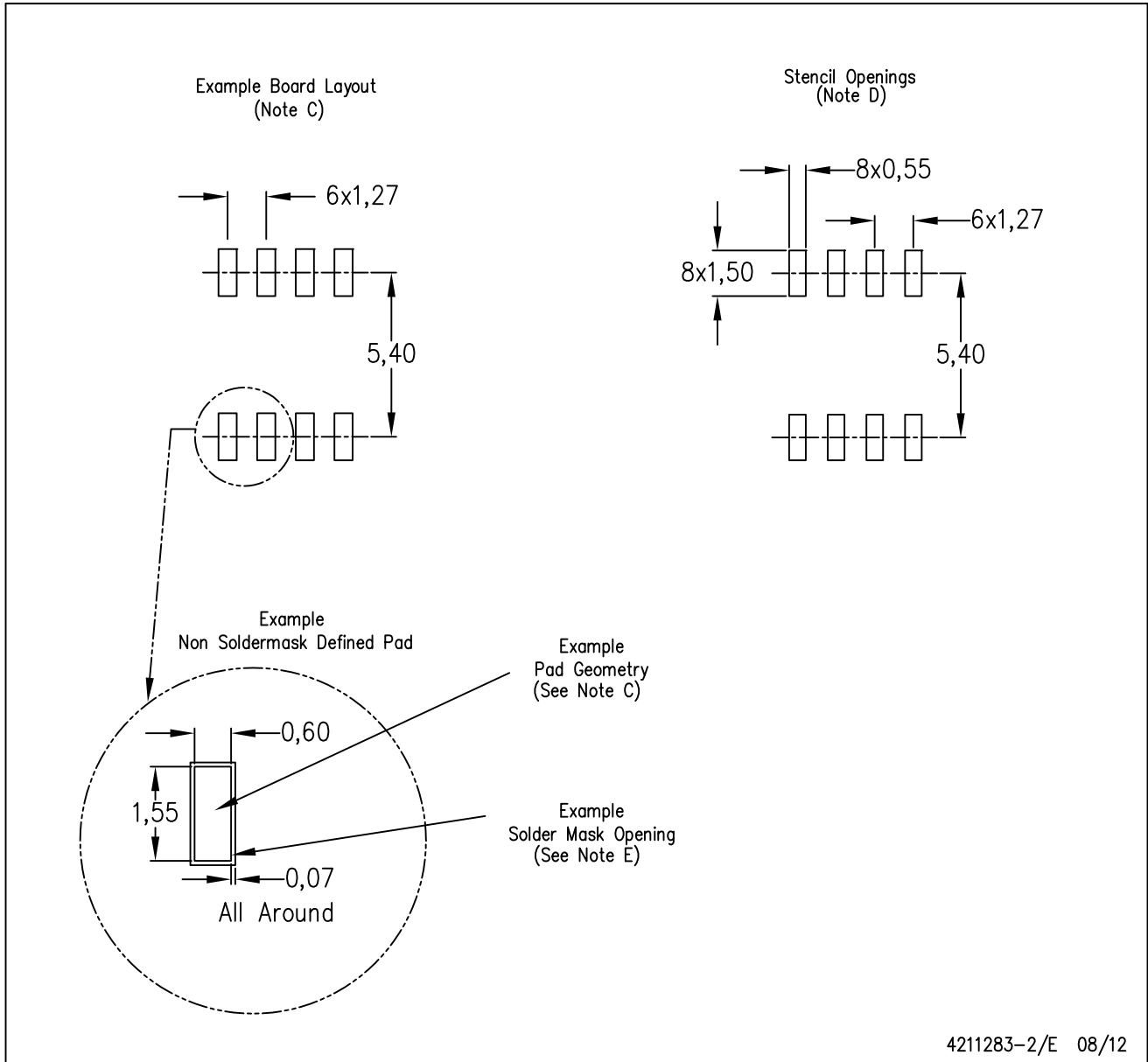

- NOTES:
- All linear dimensions are in millimeters.
 - This drawing is subject to change without notice.
 - Publication IPC-7351 is recommended for alternate designs.
 - Laser cutting apertures with trapezoidal walls and also rounding corners will offer better paste release. Customers should contact their board assembly site for stencil design recommendations. Refer to IPC-7525 for other stencil recommendations.
 - Customers should contact their board fabrication site for solder mask tolerances between and around signal pads.

IMPORTANT NOTICE

Texas Instruments Incorporated and its subsidiaries (TI) reserve the right to make corrections, enhancements, improvements and other changes to its semiconductor products and services per JESD46, latest issue, and to discontinue any product or service per JESD48, latest issue. Buyers should obtain the latest relevant information before placing orders and should verify that such information is current and complete. All semiconductor products (also referred to herein as "components") are sold subject to TI's terms and conditions of sale supplied at the time of order acknowledgment.

TI warrants performance of its components to the specifications applicable at the time of sale, in accordance with the warranty in TI's terms and conditions of sale of semiconductor products. Testing and other quality control techniques are used to the extent TI deems necessary to support this warranty. Except where mandated by applicable law, testing of all parameters of each component is not necessarily performed.

TI assumes no liability for applications assistance or the design of Buyers' products. Buyers are responsible for their products and applications using TI components. To minimize the risks associated with Buyers' products and applications, Buyers should provide adequate design and operating safeguards.

TI does not warrant or represent that any license, either express or implied, is granted under any patent right, copyright, mask work right, or other intellectual property right relating to any combination, machine, or process in which TI components or services are used. Information published by TI regarding third-party products or services does not constitute a license to use such products or services or a warranty or endorsement thereof. Use of such information may require a license from a third party under the patents or other intellectual property of the third party, or a license from TI under the patents or other intellectual property of TI.

Reproduction of significant portions of TI information in TI data books or data sheets is permissible only if reproduction is without alteration and is accompanied by all associated warranties, conditions, limitations, and notices. TI is not responsible or liable for such altered documentation. Information of third parties may be subject to additional restrictions.

Resale of TI components or services with statements different from or beyond the parameters stated by TI for that component or service voids all express and any implied warranties for the associated TI component or service and is an unfair and deceptive business practice. TI is not responsible or liable for any such statements.

Buyer acknowledges and agrees that it is solely responsible for compliance with all legal, regulatory and safety-related requirements concerning its products, and any use of TI components in its applications, notwithstanding any applications-related information or support that may be provided by TI. Buyer represents and agrees that it has all the necessary expertise to create and implement safeguards which anticipate dangerous consequences of failures, monitor failures and their consequences, lessen the likelihood of failures that might cause harm and take appropriate remedial actions. Buyer will fully indemnify TI and its representatives against any damages arising out of the use of any TI components in safety-critical applications.

In some cases, TI components may be promoted specifically to facilitate safety-related applications. With such components, TI's goal is to help enable customers to design and create their own end-product solutions that meet applicable functional safety standards and requirements. Nonetheless, such components are subject to these terms.

No TI components are authorized for use in FDA Class III (or similar life-critical medical equipment) unless authorized officers of the parties have executed a special agreement specifically governing such use.

Only those TI components which TI has specifically designated as military grade or "enhanced plastic" are designed and intended for use in military/aerospace applications or environments. Buyer acknowledges and agrees that any military or aerospace use of TI components which have **not** been so designated is solely at the Buyer's risk, and that Buyer is solely responsible for compliance with all legal and regulatory requirements in connection with such use.

TI has specifically designated certain components as meeting ISO/TS16949 requirements, mainly for automotive use. In any case of use of non-designated products, TI will not be responsible for any failure to meet ISO/TS16949.

Products

Audio	www.ti.com/audio
Amplifiers	amplifier.ti.com
Data Converters	dataconverter.ti.com
DLP® Products	www.dlp.com
DSP	dsp.ti.com
Clocks and Timers	www.ti.com/clocks
Interface	interface.ti.com
Logic	logic.ti.com
Power Mgmt	power.ti.com
Microcontrollers	microcontroller.ti.com
RFID	www.ti-rfid.com
OMAP Applications Processors	www.ti.com/omap
Wireless Connectivity	www.ti.com/wirelessconnectivity

Applications

Automotive and Transportation	www.ti.com/automotive
Communications and Telecom	www.ti.com/communications
Computers and Peripherals	www.ti.com/computers
Consumer Electronics	www.ti.com/consumer-apps
Energy and Lighting	www.ti.com/energy
Industrial	www.ti.com/industrial
Medical	www.ti.com/medical
Security	www.ti.com/security
Space, Avionics and Defense	www.ti.com/space-avionics-defense
Video and Imaging	www.ti.com/video

TI E2E Community

e2e.ti.com

Mouser Electronics

Authorized Distributor

Click to View Pricing, Inventory, Delivery & Lifecycle Information:

[Texas Instruments:](#)

[ISO7420FEDR](#) [ISO7420FED](#) [ISO7420ED](#) [ISO7420EDR](#) [ISO7421ED](#) [ISO7421EDR](#) [ISO7421FED](#) [ISO7421FEDR](#)