



Medical & ITE General Purpose

Rated 160W
Max. 240W
Peak 320W
SNP-G16 Series

李春华 13701301733
北京融源科技有限公司
 地址：北京市海淀区小营西路16号北楼522室
 电话：010-82714837
 QQ：37823822 微信：同手机或QQ号码
 E-mail: shian100@126.com
<http://www.rypower.com>



3" x 5" x 1.42"

General Specifications:

Input voltage 90 VAC to 264 VAC
 Input frequency 47 Hz to 63 Hz
 Inrush current < 30/60A at 115/230VAC
 Hold up time 20ms typical
 Over load/Short circuit protection auto recovery
 Over voltage protection latch off
 Operating temperature -20°C to 70°C
 derating: 2.5% / °C > 50°C for convection cooling
 Storage temperature -40°C to +85°C

Features:

- Peak load (1.4 ~ 2 x rated current, Vo=rated for 5 sec)
- Design for BF application
- Convection cooling for Rated power
- Built-in PFC and 12V output for fan, available for G12x, G16x, and G20x
- EMI class B
- -20°C to +70°C operating temperature

Applications:

- For peak load and surge load applications, such as motor drive, coffee machine, vending machine, gaming machine, and otehr industrials.
- For EMI class B application, such as home healthcare device, and other medical devices.

EMI EN55022 "B", EN61000-3-3
 Harmonics.....EN61000-3-2, class D
 EMS..... EN61000-4-2,-3,-4,-5,-6,-8,-11
 Safety UL/CSA/EN60950-1, 2nd edition
 ANSI/AMMI/CSA/EN60601-1, 3.1 edition
 CB report, CE mark, RM report/file
 Energy Saving (for w/o -A suffix) ENERGY STAR
 for computers version 6.0
 for displays version 6.0
 ErP regulation EC(No) 1275/2008

Mechanical Specifications:

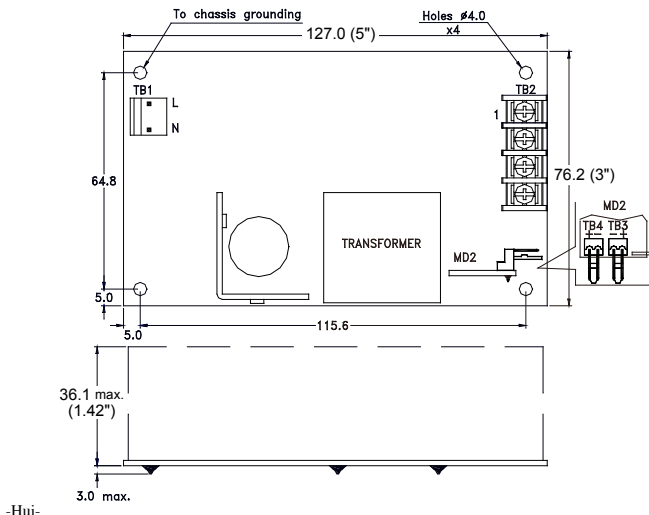

Notes:

1. Size:
3" x 5" x 1.42"
2. Mounting Hole:
64.8 x 115.6 (mm)
3. Connectors:
AC input: Molex 5277-02A or equivalent
DC output: Terminal blocks (default for SNP-G167) or Molex 5273-08A (default for others) or equivalent
Fan, Remote sense: Molex 5045-02A or equivalent
4. Output Pin assignment:

Pin No.	1	2	3	4	5	6	7	8
SNP-G167	+Vo	+Vo	GND	GND				
OTHER MODELS	+Vo	+Vo	+Vo	+Vo	GND	GND	GND	GND

Function Pin	TB3	TB4
	FAN Output	Remote Sense
1	GND	Sense -
2	+12V	Sense +
5. Packing:
Net weight: 353 g approx. / unit
Gross weight: 15 kg approx. / carton, 36 units / carton
Carton size (mm): 384 (L) x 339 (W) x 327 (H)

10 years Warranty (contact Skynet's Distributors for details)

Output Specifications:

MODEL NO.	OUTPUT RAIL	LOAD				INITIAL ACCURACY	STEP EFFICIENCY			AVERAGE EFFICIENCY
		MIN.	RATED	MAX.	PEAK		@ 20% LOAD	@ 50% LOAD	@ 100% LOAD	
SNP-G167 SNP-G167 -A SNP-G167 -M SNP-G167 -MA	+12V	0A	13.3A	20A	26.6A	+11.9V~+12.1V	80%	88%	89%	85.5%
SNP-G168 SNP-G168 -A SNP-G168 -M SNP-G168 -MA	+15V	0A	10.66A	16A	21.3A	+14.9V~+15.1V	80%	88%	89%	85.5%
SNP-G165 SNP-G165 -A SNP-G165 -M SNP-G165 -MA	+18V	0A	8.88A	13.33A	17.8A	+17.9V~+18.1V	80%	88%	89%	85.6%
SNP-G169 SNP-G169 -A SNP-G169 -M SNP-G169 -MA	+24V	0A	6.66A	10A	13.3A	+23.9V~+24.1V	80%	87%	89%	85.3%
SNP-G16G SNP-G16G-A SNP-G16G-M SNP-G16G-MA	+28V	0A	5.7A	8.55A	11.4A	+27.9V~+28.1V	80%	90%	90%	86.6%
SNP-G16J SNP-G16J -A SNP-G16J -M SNP-G16J -MA	+36V	0A	4.45A	6.66A	8.9A	+35.8V~+36.2V	80%	89%	89%	86%
SNP-G16T SNP-G16T -A SNP-G16T -M SNP-G16T -MA	+48V	0A	3.35A	5A	6.67A	+47.8V~+48.2V	90%	90%	89%	86.6%

Note:

- Standby Power Consumption with System:**
For computers and displays, ENERGY STAR in U.S. and ErP regulation in Europe require the input power should be less than 0.5W at standby mode.
- Output Load:**
160W for convection cooling; 240W for forced air cooling.
- Peak Load Duration:**
Peak 320W can last for 5 sec.
- Isolation Grade:**
Primary ↔ Ground : 1MOPP (1500Vac)
Primary ↔ Secondary : 2MOPP (4000Vac)
Secondary ↔ Ground : 1MOPP (1500Vac)
- Leakage Current:**
Earth leakage current < 300uA
Touch current < 100uA
- EMI Grounding:**
If there is a metal sheet under the power supply, connect the EMI ground to the metal sheet.
- Model Selection:**
Most of power supplies will create audible burst sound at light load, if the application wants to meet input power < 0.5W at standby mode.
SNP-G16x is for ITE application which requires standby mode.
SNP-G16x-A is for ITE application but without burst sound and no standby mode.
SNP-G16x-M is for medical application which requires standby mode.
SNP-G16x-MA is for medical application but without burst sound and no standby mode.

李春华 13701301733
北京融源科技有限公司
地址：北京市海淀区小营西路16号北楼522室
电话：010 - 82714837
Q Q：37823822 微信：同手机或QQ号码
E-mail:shian100@126com
<http://www.rypower.com>

Performance for SNP-G167:

1. Switching frequency ripple

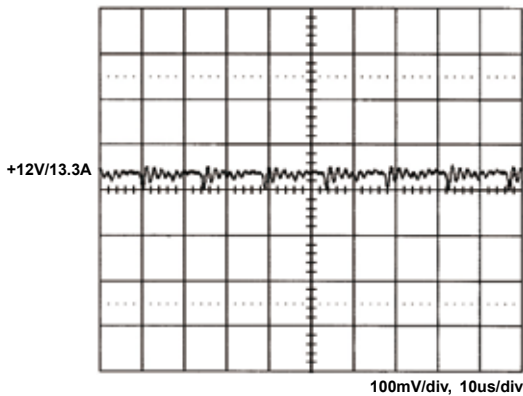

2. Line frequency ripple

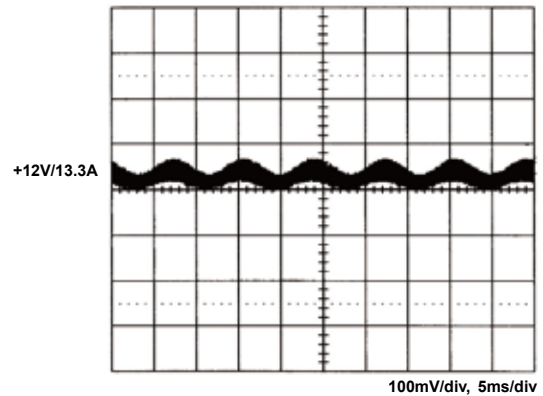

3. Output turn on wave form

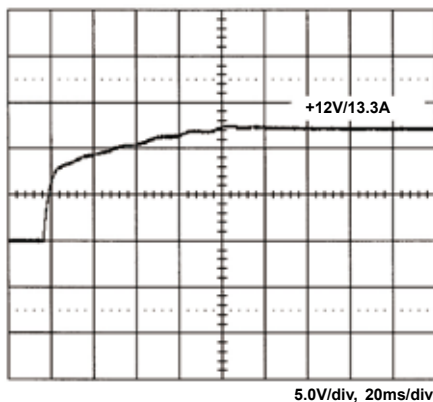

4. Output turn off wave form

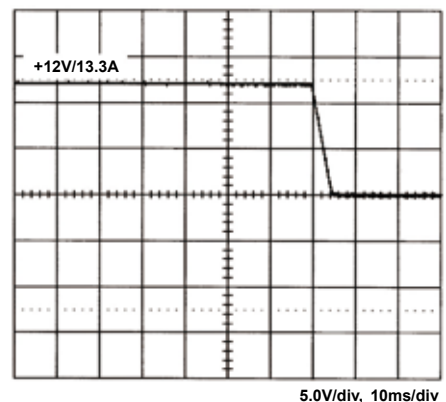

5. Hold-up time

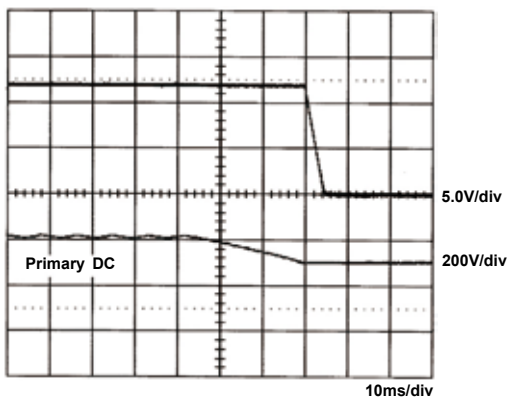

6. Over voltage protection

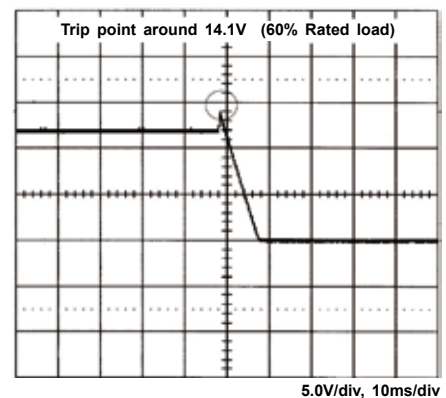

7. +12V step response

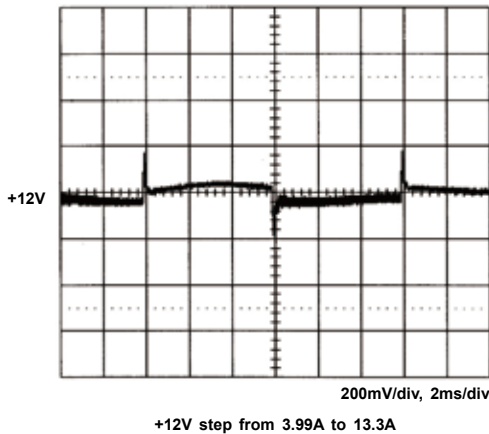

8. Peak load

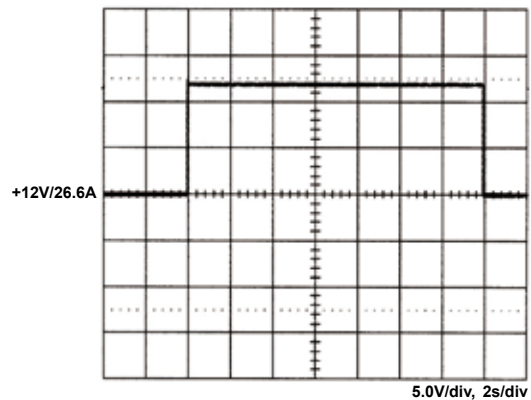

9. FCC B

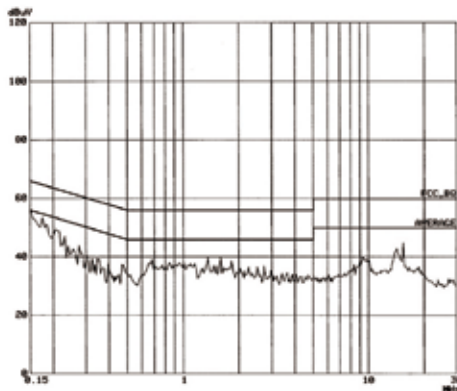

10. EN55022 B

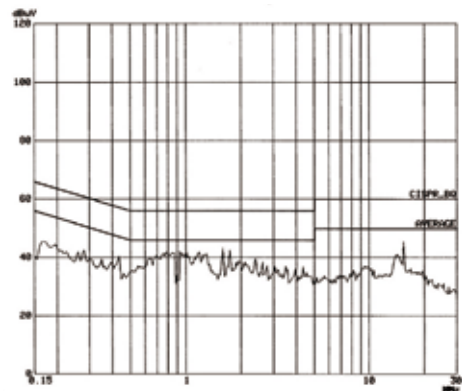

11. Power derating curve

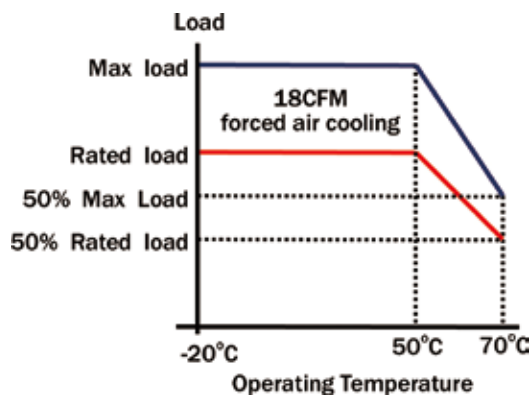

12. Capability for driving motor

