



SPECIFICATION FOR APPROVAL

Customer : _____
Product number : GY-5W4DCN-WG-RL008UP402-25
Product Description : Φ4 white transparent LED
Sample order : 20171202
Date : 2017-12-2

Approved By	Prepared By
Nuclear quasi :	Nuclear quasi : Yu Qing Quan
Engineering :	Engineering : Wang Qing
Quality :	Quality : Wang Zong Lin
Purchase :	Design : Ling Ke Yu

SPECIFICATION:

We are sending you our specification and drawings for your approval. Please return to us one copy of "For Approval" with your approved signatures

Changsheng photoelectric co. LTD

ADD : Xinhui industrial zone, no.3 industrial park

tong tou community, shiyan street, baoan district, shenzhen city

TEL : 15015461218 Email address: 925817001@qq.com

Web : <http://www.zcsled.cn/>

Note: this specification does not recommend using ac, such as improper operation, cause accidental death lamp or other adverse phenomenon, this company is not responsible for ! Advising clients to set the current to use this product, please let us know if they set the voltage to use the product.

1. overview

- * Low power consumption
- * Low power
- * General equipment on the PCB board or panel
- * with IC Supporting the use/Low current requirement

2. Product appearance size figure

(unit : mm)

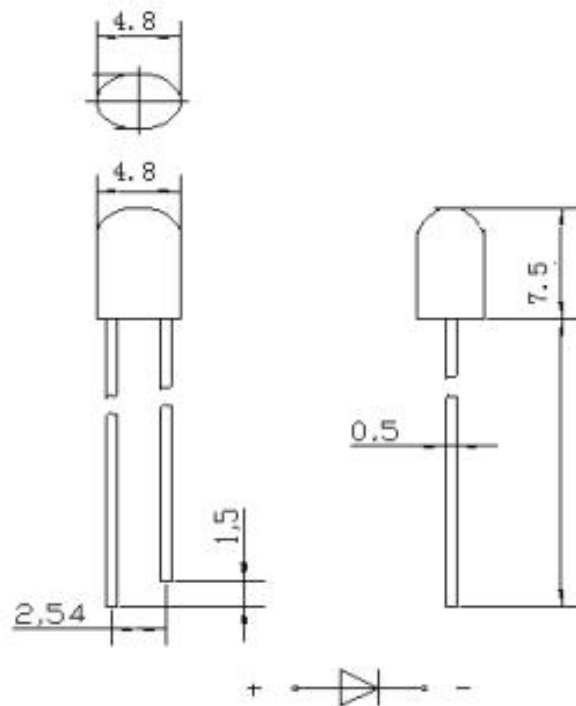

Note :

- 1 : All dimensions are in millimeters (inches).
- 2 : All dimension tolerance is ± 0.2 mm unless otherwise noted.
- 3: Specifications are subject to change without notices.
- 4 : This specification is for reference only for one year

3. parameter

3.1 The limit parameter (room temperature 25°C)

parameter	The numerical	Unit
Dissipation power	95	mW
Pulse current (1/10 work loops 0.1 millisecond pulse width)	100	mA
Working current (IF)	20	mA
Reverse voltage (VR)	5	V
Working temperature range	-40°C ~ +75°C	
Storage temperature range	-40°C ~ +100°C	
Soldering temperature from the roots (4.0 mm)	250°C for 3 Seconds	

Photoelectric parameters At room temperature 25°C

Parameter	min	Avg	max	Unit	Test Condition
Luminous intensity	400	-----	1100	mcd	If=20mA
Light Angle(2 θ 1/2)	-----	60	-----	deg	If=20mA
X / Y value	0. 45-0. 41	0. 46-0. 42	0. 47-0. 43	-----	If=20mA
electric voltage	2. 8	-----	3. 6	V	If=20mA
Reverse current		-----	5	μA	Vr=5V

Selection Guide:

Colloid color	Chip		
	Material	Emitting light colors	λp (nm)
Water clear	InGaN/GaN	White	-----

4、Under the condition of 25 °C electrical diagram:

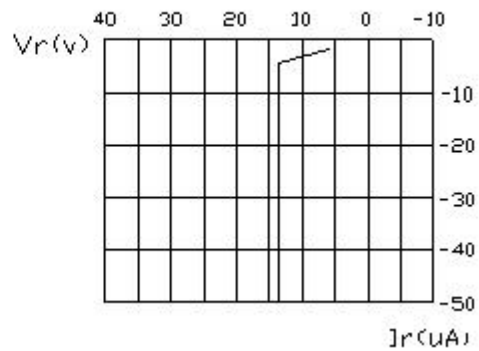
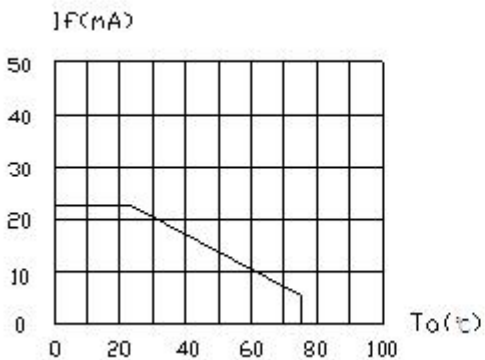
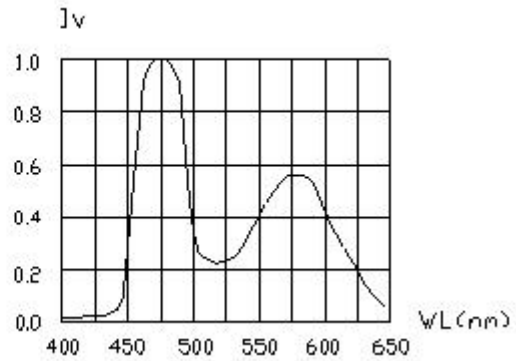
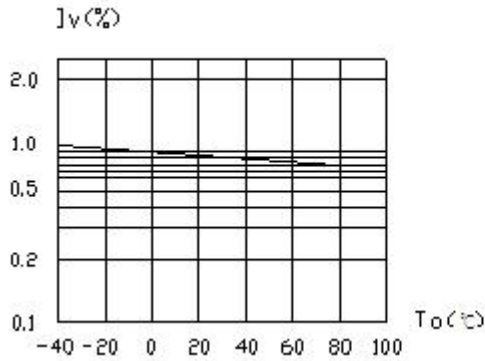
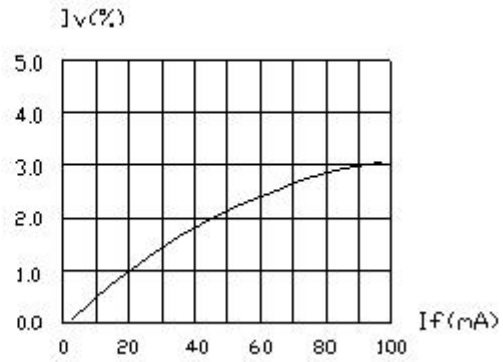
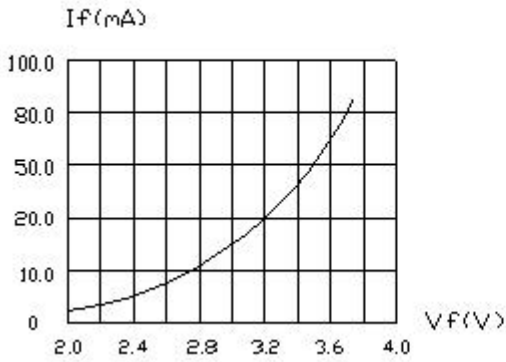

Note: this specification does not recommend using ac, such as improper operation, cause accidental death lamp or other adverse phenomenon, this company is not responsible for ! Advising clients to set the current to use this product, please let us know if they set the voltage to use the product.

5. Not dry glue label

P/N: Product number

VF: Forward voltage

BIN: points light

IV: Luminous intensity

WL: Color/wavelength

QTY: number

QC: Production order



Part No: XXXXXXXXXXXXXXXXXXXXXXXXXX

VF (V): XXXXXXXX BIN:

IV: XXXXXXXX WL: XXXXXXXX

QTY: XXXXXXXX QC: XXXXXXXX

6. packaging

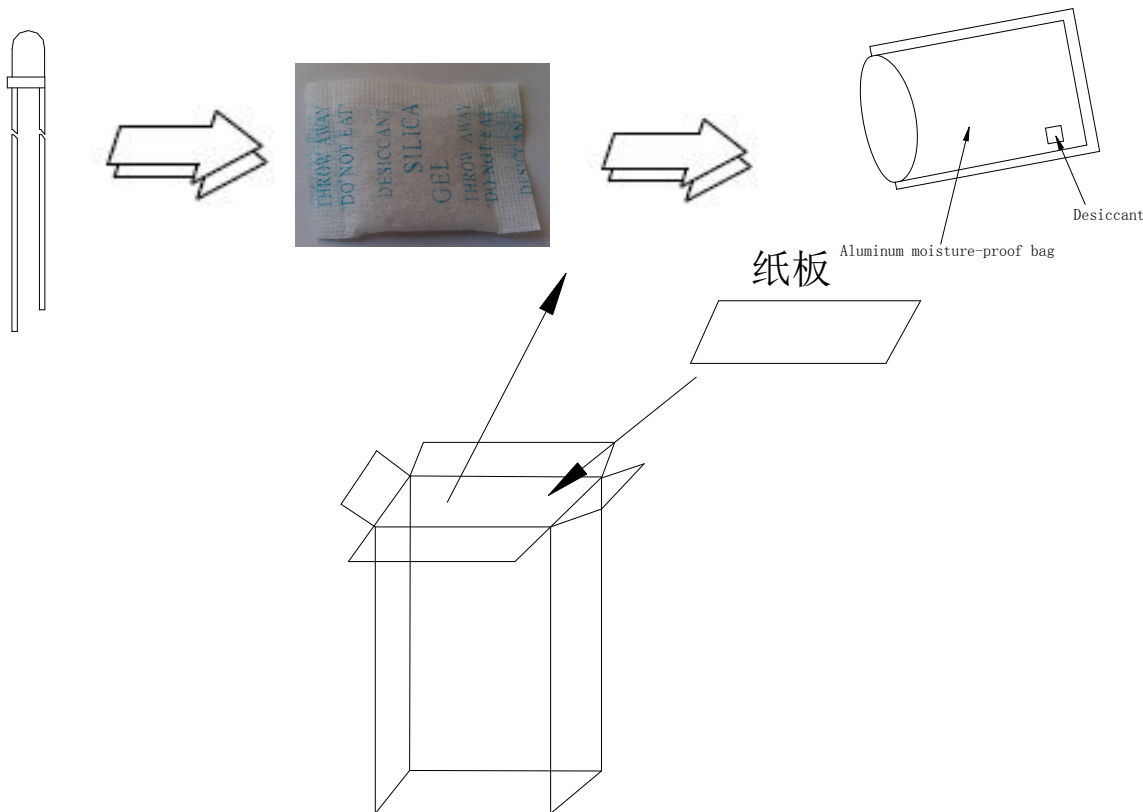

The packing way : Electrostatic bag packing

Packing specification : White light color packing 500 PCS/bag, puguang 500 PCS/bag ◦

Pay attention to : Above belongs to the normal packing specification, if you have any special requirements according to customer requirements

Note: this specification does not recommend using ac, such as improper operation, cause accidental death lamp or other adverse phenomenon, this company is not responsible for ! Advising clients to set the current to use this product, please let us know if they set the voltage to use the product.

7. The cautions of stent deformation

Stent deformation must be conducted before welding, plastic, stent bend position must be at least 3 mm at the bottom of the encapsulating resin, at the same time, avoid bent many times on the same position. When the deformation, fixed bracket, please use the right tools to avoid resin pressure. Especially not as a pivot pin connected with the resin part, so the stress within the product on light emitting structure directly into damage, lead to the change of product features and even damaged. For the same reason, in the assembly of products, the distance between welding PCB hole must be in the pin spacing of the products strictly match, as shown in the figure below :

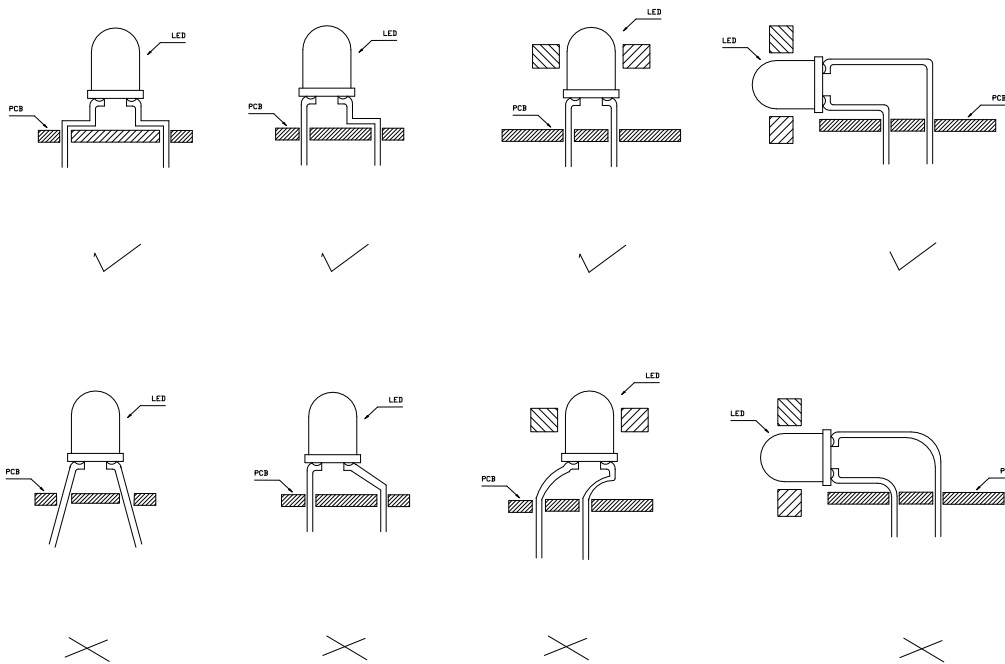

✓ correct mounting methods

✗ Incorrect mounting methods

Note: this specification does not recommend using ac, such as improper operation, cause accidental death lamp or other adverse phenomenon, this company is not responsible for ! Advising clients to set the current to use this product, please let us know if they set the voltage to use the product.

8. Reliability of the experimental project and conditions

serial number	Test project	The test conditions	The sample quantity	Acceptance/rejection
1	Life test	Test current : 20MA The temperature : 25°C The test of time : 1000 hours	20	0/1
2	High temperature high humidity (static test)	The temperature : =+65°C humidity : 90% RH The test of time : 240 hours	20	0/1
3	Cold and hot shock	-40°C ~ +100°C 20min 10s 20min Test time: 100 loops	20	0/1
4	High temperature storage	The high temperature : 100°C The test of time : 1000 hours	20	0/1
5	Low temperature storage	The low temperature : -40°C The test of time : 1000 hours	20	0/1
6	Temperature loop	-40°C ~ +100°C 60min 20s 60min Test time: 20 loops	20	0/1
7	Reflow soldering	260°C (Max) , the maximum of no more than 5 seconds	20	0/1

Reliability experiment unqualified judgement standard

IV: Attenuation is more than 30%

VF: Change is more than 20%

note : 1) Same project the results of the test must be completed within 2 hours °

2) Testing must be completed in each experiment. Material return to normal conditions °

Note: this specification does not recommend using ac, such as improper operation, cause accidental death lamp or other adverse phenomenon, this company is not responsible for ! Advising clients to set the current to use this product, please let us know if they set the voltage to use the product.

9. ESD protective

LED is a semiconductor device, the static sensitive, especially for white, green, blue, purple LED to make efforts to prevent electrostatic generation and eliminate static electricity ◦

9.1 The generation of static electricity

a. Friction: in daily life, any two objects of different material contact after the separation, can produce static, and the one of the most common method of generation of static electricity, is the electrification. The insulation material, the better, the easier the electrification. In addition, any two objects of different material contact again after separation, also can produce static electricity ◦

b. Induction: in view of the conductive material, because electrons can flow freely in its surface, such as to be put in the electric field, due to the same, opposites attract, the positive and negative ions will move, can produce electric charge on the surface ◦

c. Conduction: in view of the conductive material, because electrons can flow freely in surface, such as contact with a charged object, the charge transfer will occur ◦

9.2 The dangers of static electricity on the LED :

- a. For the moment's electric field or electric current produced by the heat, the LED local injury ◦
- b. Because of destruction of the electric field or current LED insulation layer, the device will not work (destroyed) characterized by death lamp ◦

9.3 Electrostatic protection and measures to eliminate

For the entire process (production, testing, packaging, etc.) all employees in direct contact with the LED to measures to prevent and eliminate static electricity, mainly :

- a. Laying anti-static workshop floor and well grounded ◦
- b. Workbench for esd workstation, production machines grounding is good ◦
- c. Operators wear anti-static clothing, anti-static hand ring, gloves or foot ring ◦
- d. Application of ion fan, the welding electric grounding measures ◦
- e. Packing with antistatic materials ◦