



SAMSUNG DISPLAY



Product Specification

- () Product Information
- () Preliminary Specification
- () Approval Specification

Any modification of Spec is not allowed without SDC's permission.

CUSTOMER	R/A Customer
DATE OF ISSUE	2015/01/12

MODEL NO.	LTI460HN11
EXTENSION CODE	-0

Customer Approval & Feedback

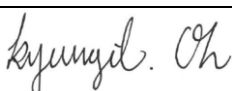
Approved by	 2015/01/12
Prepared by	 2015/01/12

**Customer Support Engineering Group
Samsung Display Co., Ltd**

Table of Contents

REVISION HISTORY	3
GENERAL DESCRIPTION	4
1. ABSOLUTE MAXIMUM RATINGS	
1.1 ENVIRONMENTAL ABSOLUTE RATINGS	6
1.2 ELECTRICAL ABSOLUTE RATINGS	7
1.3 THE OTHERS ABSOLUTE RATINGS	7
2. APPLICATION INFORMATION FOR DID(DIGITAL INFORMATION DISPLAY)	8
3. OPTICAL CHARACTERISTICS	9
4. ELECTRICAL CHARACTERISTICS	
4.1 TFT LCD MODULE	12
4.2 BACK LIGHT UNIT	13
4.3 LED CONVERTER CHARACTERISTICS	14
5. INPUT TERMINAL PIN ASSIGNMENT	
5.1 INPUT SIGNAL & POWER	15
5.2 LED CONVERTER INPUT PIN CONFIGURATION	17
5.3 LED CONVERTER POWER SEQUENCE	17
5.4 LVDS INTERFACE	18
5.5 INPUT SIGNALS, BASIC DISPLAY COLORS AND GRAY SCALE	19
6. INTERFACE TIMING	
6.1 TIMING PARAMETERS (DE ONLY MODE)	20
6.2 TIMING DIAGRAMS OF INTERFACE SIGNAL (DE ONLY MODE)	21
6.3 CHARACTERISTICS OF INPUT DATA OF LVDS	22
6.4 THE SEQUENCE OF POWER ON AND OFF	24
7. OUTLINE DIMENSION	24
8. RELIABILITY TEST	27
9. PACKING	28
10. MARKINGS & OTHERS	29
11. GENERAL PRECAUTIONS	
11.1 HANDLING	30
11.2 STORAGE	31
11.3 OPERATION	31
11.4 OPERATION CONDITION GUIDE	31
11.5 OTHERS	32

REVISION HISTORY

Date	Rev.No.	Page	Revision Description
2014/12/15	000	all	Approval Specification Firstly issued
2015/01/12	002	4	Modify the comment regarding Black fog mura
		26	Modify the location of LVDS Connector → Moved to left by 10.10mm from center

GENERAL DESCRIPTION

DESCRIPTION

LTI460HN11-0 is a color active matrix liquid crystal display(LCD) that uses amorphous silicon TFT(Thin Film Transistor) as switching components. This model is composed of a TFT LCD panel, a driver circuit, and a back-light unit. This 46.0" model has a resolution of 1,920 x 1,080 pixels(16:9) can display up to 16.7 Million colors with the wide viewing angle of 89° or higher in all directions.

FEATURES

Ultra Narrow Bezel(Black Top Chassis)

- RoHS compliance(Pb-free)
- FHD(1,920X1,080) resolution(16:9)
- SVA(Super Vertical Align) mode
- High Tni(85°C) Liquid Crystal
- High speed response
- High contrast ratio, High aperture ratio with the wide color gamut
- Wide viewing angle(±178°)
- Landscape / Portrait type compatible
- LVDS(Low Voltage Differential Signaling) Interface(2pixel/clock)
- DE(Data Enable) mode
- Direct LED(Light Emitting Diode) Backlight
- Low power consumption
- Black Fog Mura Improvement Technology

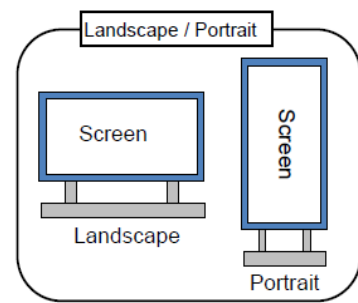

APPLICATIONS

Digital Information Display(DID)
 (If the intent to use this product is for other purpose, please contact Samsung Display.)

GENERAL INFORMATION

Item	Specification	Unit	Note
Module Size	1021.98(H) x 576.57(V)	mm	Typ
	69.7		Max(Typ)
Weight	12,000	g	Max
Display area	1018.08 (H) x 572.67 (V)	mm	
Driver Element	a-Si TFT active matrix		
Display colors	16.7M (8bit)		
Number of pixel	1,920 x 1,080	Pixel	
Pixel Arrangement	RGB Vertical stripe		
Display Mode	Normally Black		
Surface treatment	Haze 44% / 3H		Anti-Glare
Luminance of White	500(Typ)	cd/m ²	

MECHANICAL INFORMATION

Item		Min.	Typ.	Max.	Unit	Note
Module Size	Horizontal (H)	1020.98	1021.98	1022.98	mm	
	Vertical (V)	575.57	576.57	577.57	mm	
	Depth (D)	-	69.7	71.7	mm	(2)-a
-		39.9	41.9	(2)-b		
Bezel Open	Horizontal (H)	-	1018.28	-	mm	
	Vertical (V)	-	572.87	-	mm	
Black Matrix Shift	Horizontal (H)	-	-	2	mm	(1)
	Vertical (V)	-	-	2	mm	
Weight		-	11,000	12,000	g	

Note (1) Measure the figure for Black Matrix shift to be recorded on the spec. with referring to the drawings.

- $|A - B| \leq$ Horizontal Spec
- $|C - D| \leq$ Vertical Spec

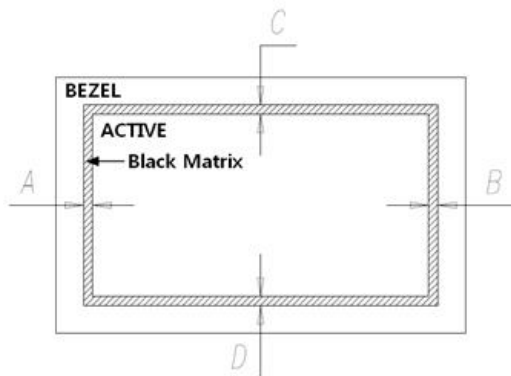

Note (2) Measure point of Depth

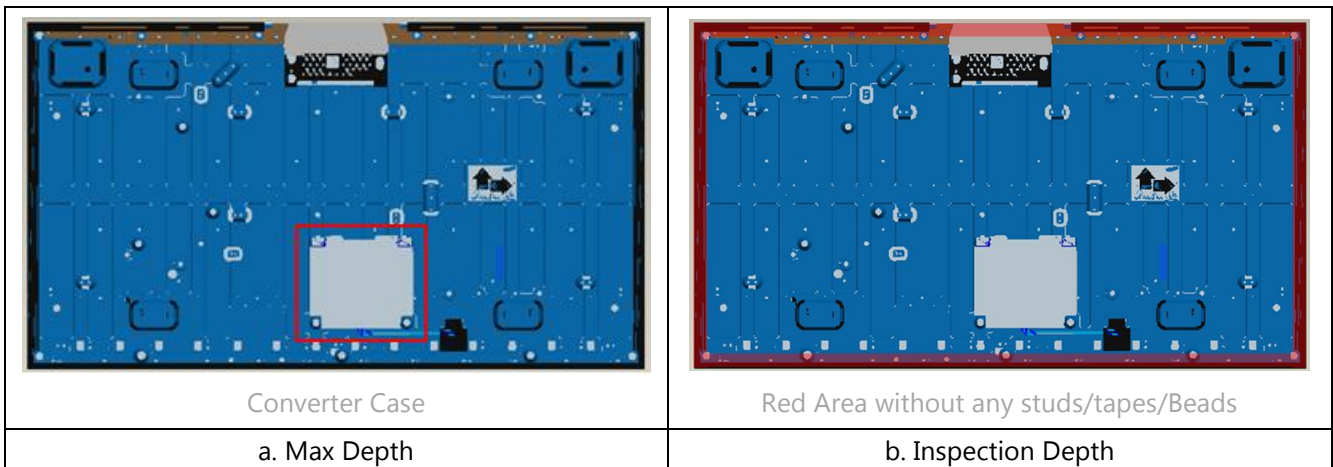

1. ABSOLUTE MAXIMUM RATINGS

1.1 ENVIRONMENTAL ABSOLUTE RATINGS

Item	Symbol	Min.	Max.	Unit	Note
Storage temperature	T _{STG}	-20	65	°C	(1)
Operation Temperature	T _{OPR}	0	50	°C	(1)
Glass Surface temperature (Operation)	Center	0	50	°C	(1), (2)
	T.Uniformity	-	10		
Storage humidity	H _{STG}	5	90	%RH	-
Operating humidity	H _{OPR}	20	90	%RG	-
Shock(non-operating)	Snop(X,Y,Z)	-	-	G	(3)
Vibration(non-operating)	V _{nop}	-	-	G	(3)

Note(1) Temperature and relative humidity range are shown in the figure below.

- a. 90% RH Max(Ta ≤ 39°C)
- b. Relative Humidity is 90% or less(Ta > 39°C)
- c. No condensation

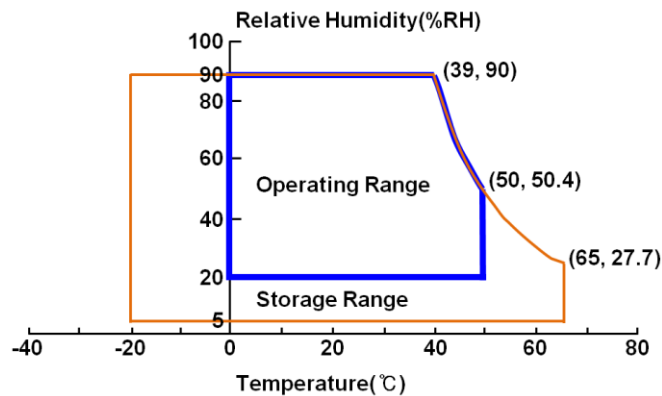

Note(2) Definition of test point

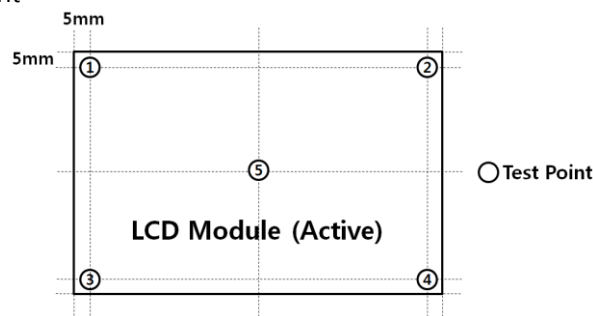

ΔT should be less than 10°C ($\Delta T = |T_{\text{CENTER}} - T_{\text{CORNER}}|$)

T_{CENTER} : Temperature of the center of the glass surface (Test point 5)

T_{CORNER} : Temperature of each edge of the glass surface (Test point 1~4)

Note(3) SDC don't guarantee about Module vibration and shock of LTI460HN11-0 due to UNB's characteristic.

1.2 ELECTRICAL ABSOLUTE RATINGS

(1) TFT LCD MODULE

Item	Symbol	Max	Unit	Note
Power Supply Voltage	VDD	13.2	V	(1)

(2) BACKLIGHT UNIT(LED Unit)

Item	Symbol	Max	Unit.	Note
Input Supply Voltage	V _{CC}	26	V	(1)

Note(1) Ta= 25 ± 2 °C

The permanent damage or defect to the device may occur if the panel is operated at the figure set, which exceeds a ceiling of maximum value stated in the former spec. The functional operation should be limited to the conditions described above under normal operating conditions.

1.3 THE OTHERS ABSOLUTE RATINGS

Static Electricity Pressure Resistance

Item	Test Conditions	Remark
Contact Discharge	150pF, 330Ω, ±10kV, 210points, 1time/point	Operating
Air Discharge	150pF, 330Ω, ±20kV, 210points, 1time/point	

2. APPLICATION INFORMATION FOR DID (Digital Information Display)

A DID's screen may display the sudden image such as an image retention.
To extend the lifetime and optimize a function of module, the below-mentioned operating conditions are required.

2.1 Normal operating condition

- a. Temperature: 20 ±15℃
- b. Humidity: 55 ±20 %
- c. Display pattern: Moving image or image, which switches regularly.
Note) The sudden image on the screen can be displayed after the static image is shown in the long-term.

2.2 The operating conditions when the module is operated under the abnormal condition.

- a. Ambient condition
-It is recommended to set the DID up in the well-ventilated place.
- b. The function of power off and screen saver
-The function of periodical power-off or a screen saver is needed when the static image is displayed in the long-term.

2.3 Operating conditions to prevent the sudden display resulted from displaying the static image in the long-term.

- a. ***The proper operating time: Under 20 hours a day.***
- b. The moving image shall be inserted between the static displays periodically.
-The refresh time for liquid crystal is needed.
- c. The periodic changing of background color and character's color(image)
-Use the different color for background and character (image) respectively.
-Change colors periodically.
- d. Avoid combining the color for background with the color for character, which has a largely different luminance.
Note (1) Abnormal condition means all operating condition except normal operating condition.
Note (2) The moving image or black pattern is strongly recommended as a screen saver.

2.4 Only the lifetime of DID stated in this spec is guaranteed if the DID is used under the proper operating conditions.

2.5 Clean the system regularly for not accumulating the dust around the system considering user environment, otherwise, its reliability and function may not be satisfied.

3. OPTICAL CHARACTERISTICS

The optical characteristics should be measured in a dark room or equivalent.

Measuring equipment : TOPCON RD-80S, SR-3, ELDIM EZ-Contrast

Ta = 25 ± 2 °C, V_{DD} = 12V, fv = 60Hz, f_{DCLK} = 148.5MHz, I_F = 100% duty

Item	Symbol	Condition	Min	Typ	Max	Unit	Note	
Contrast Ratio	C/R	-	2500	3500	-	-	(3) SR-3	
Response time	G-to-G (AVG)	T _g	-	8	16	msec	(5) RD-80S	
Luminance of White (At the center of screen)	Y _L	-	400	500	-	cd/m ²	(6) SR-3	
Color Chromaticity (CIE 1931)	Red	R _X	Normal φ = 0 θ = 0 Viewing Angle	0.640	TYP. -0.03	TYP +0.03	-	(7), (8) SR-3
		R _Y		0.330				
	Green	G _X		0.300				
		G _Y		0.600				
	Blue	B _X		0.150				
		B _Y		0.060				
	White	W _X		0.280				
		W _Y		0.290				
Color Gamut	-	-	69	72	-	%	(7) SR-3	
Color temperature	-	-	8000	10000	-	K		
Viewing Angle	Hor.	θ _L	CR ≥ 10	75	89	-	Degree	(8) SR-3 EZ-Contrast
		θ _R		75	89	-		
	Ver.	θ _U		75	89	-		
		θ _D		75	89	-		
Brightness Uniformity (9 Point)	B _{uni}	-	-	-	25.0	%	(4) SR-3	

Note(1) Test Equipment Setup

The measurement should be executed in a stable, windless and dark room between 40min and 60min after lighting the backlight at the given temperature for stabilization of the backlight. This should be measured in the center of screen.

Environment condition : Ta = 25 ± 2 °C

Note(2) Definition of test point

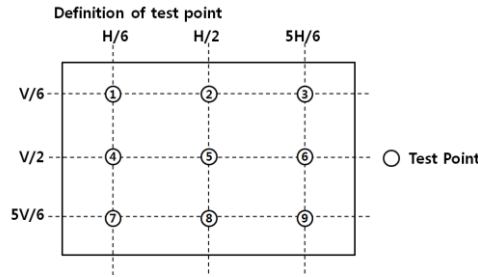

Note(3) Definition of Contrast ratio(C/R)

: Ratio of max.gray(Gmax) & min.gray(Gmin) at the center point ⑤ of the panel.

$$C / R = \frac{G \max}{G \min}$$

Gmax : Luminance in all white pixels
Gmin : Luminance in all black pixels.

Note(4) Definition of brightness uniformity at 9 points(Test pattern : Full white)

$$Buni = 100 * \frac{(B \max - B \min)}{B \max}$$

Bmax : Maximum brightness
Bmin : Minimum brightness

Note(5) Definition of Response time : Average response time of all Gray to Gray except Tr, Tf

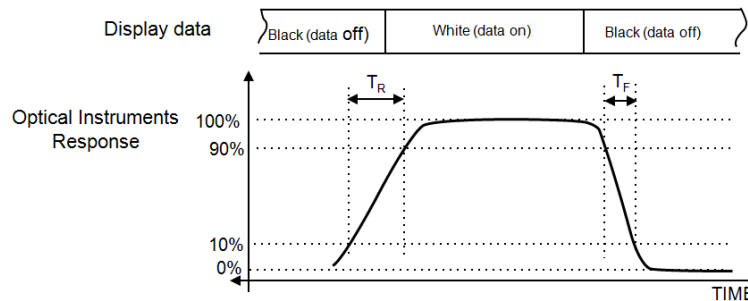

※ G-to-G : Average response time between the whole gray scale to the whole gray scale.

Gray to Gray Response Time										
	Gray	End								
		0	31	63	95	127	159	191	223	255
Start	0		Tr(0-31)	Tr(0-63)	Tr(0-95)	Tr(0-127)	Tr(0-159)	Tr(0-191)	Tr(0-223)	Tr(0-255)
	31	Tr(31-0)		Tr(31-63)	Tr(31-95)	Tr(31-127)	Tr(31-159)	Tr(31-191)	Tr(31-223)	Tr(31-255)
	63	Tr(63-0)	Tr(63-31)		Tr(63-95)	Tr(63-127)	Tr(63-159)	Tr(63-191)	Tr(63-223)	Tr(63-255)
	95	Tr(95-0)	Tr(95-31)	Tr(95-63)		Tr(95-127)	Tr(95-159)	Tr(95-191)	Tr(95-223)	Tr(95-255)
	127	Tr(127-0)	Tr(127-31)	Tr(127-63)	Tr(127-95)		Tr(127-159)	Tr(127-191)	Tr(127-223)	Tr(127-255)
	159	Tr(159-0)	Tr(159-31)	Tr(159-63)	Tr(159-95)	Tr(159-127)		Tr(159-191)	Tr(159-223)	Tr(159-255)
	191	Tr(191-0)	Tr(191-31)	Tr(191-63)	Tr(191-95)	Tr(191-127)	Tr(191-159)		Tr(191-223)	Tr(191-255)
	223	Tr(223-0)	Tr(223-31)	Tr(223-63)	Tr(223-95)	Tr(223-127)	Tr(223-159)	Tr(223-191)		Tr(223-255)
	255	Tr(255-0)	Tr(255-31)	Tr(255-63)	Tr(255-95)	Tr(255-127)	Tr(255-159)	Tr(255-191)	Tr(255-223)	
T _{OFF}										

T*(X-Y) : Response time from level of gray at X to level of gray at Y

The definition of response time = $\sum [T*(X-Y)] / 72$

Note(6) Definition of Luminance of White : Luminance of white at center point ⑤

Note(7) Definition of Color Chromaticity (CIE 1931)

Color coordinate of Red, Green, Blue & White at center point ⑤

Note(8) Definition of Viewing Angle : Viewing angle range($C/R \geq 10$)

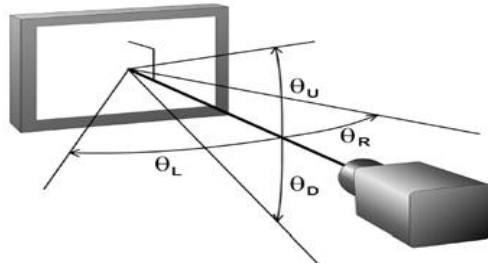

4. ELECTRICAL CHARACTERISTICS

4.1 TFT LCD MODULE

The connector to transmit a display data and a timing signal should be connected.

Ta = 25 ± 2 °C

Item	Symbol	Min	Typ	Max	Unit	Note
Voltage of Power Supply	V _{DD}	10.8	12	13.2	V	(1)
Current of Power Supply	(a) Black	-	650	750	mA	(2), (3)
	(b) White	-	600	700		
	(C) N-Pattern	-	900	1,000		
Vsync Frequency	f _V	48	60	62	Hz	-
Hsync Frequency	f _H	54	67.5	69.75	kHz	-
Main Frequency	F _{dclk}	130	148.5	152.5	MHz	-
Rush Current	I _{RUSH}	-	-	2	A	(4)

Note(1) The ripple voltage should be controlled under 10% of V_{DD}.

Note(2) f_V=60Hz, f_{DCLK}=148.5MHz, V_{DD}=12.0V, DC Current.

Note(3) The pattern for checking the power dissipation (LCD module only).

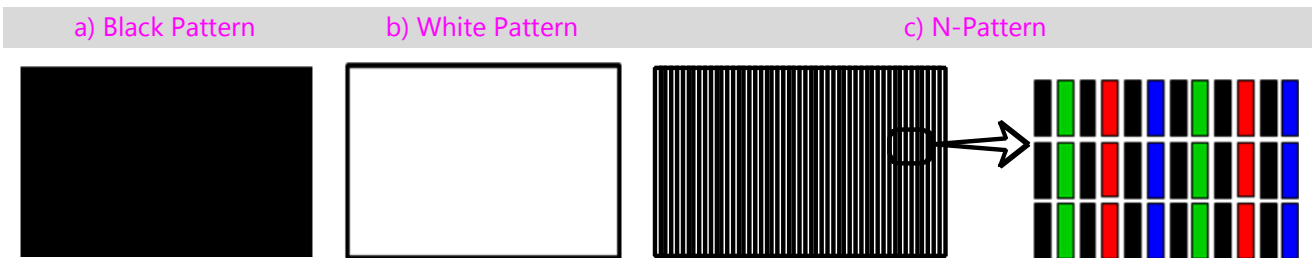

Note(4) Conditions for measurement

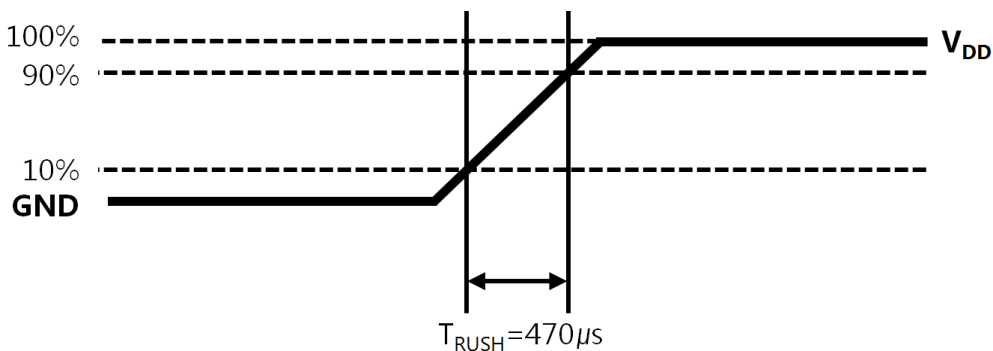

The rush current, I_{RUSH} can be measured when T_{RUSH} is 470µs.

4.2 BACK LIGHT UNIT

The back light unit contains 112 LEDs(Light Emitting Diode).
 The characteristics of BLU are shown in the following tables.

Ta = 25 ± 2 °C

Item	Symbol	Min	Typ	Max	Unit	Note
Operating Life Time	Hr	-	50,000	-	Hour	(1)

Note(1) It is defined as the time to take until the brightness reduces to 50% of its original value.

[Operating condition : Ta = 25±2 °C]

4.3 LED CONVERTER CHARACTERISTICS

Items	Symbol	Conditions	Specifications			Unit	Note
			Min	Typ	Max		
Input Voltage	V_{in}	-	22	24	26	V	$T_a=25\pm 2^{\circ}C$
Inrush Current	I_{inrush}	$V_{in} = 24V$ Dim = Max	-	-	4.0		(2)
Output Current	I_{LED}	$V_{in} = 24V$ Dim = Max	190	200	210	mA (rms)	Per String
Backlight On/Off Control	ENA	Enable	2.4	-	5.25	V	-
		Disable	-0.3	-	0.4		
Analog Dimming	V_{A_Dim}	$V_{in} = 24V$	0	-	3.3	V	(3)
	D_{A_Dim}		20	-	100	%	

Note(1) All data was approved after running 120 minutes.

Note(2) Inrush is measured within BLU on 10ms after leaving the BLU as it is at least 1hr or more at room temperature(25°C).

Note(3) High-duty = On/(On+Off)*100

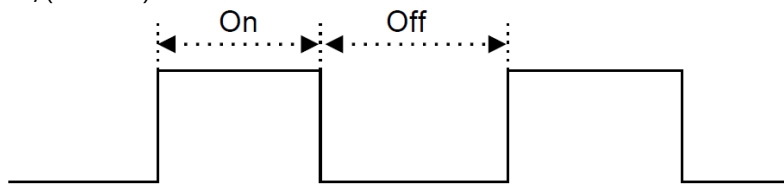

※ Additional appendix for supply current(@ 25°C)

Items	Symbol	Conditions	Specification			Unit
			Min	Typ	Max	
Input Current	$I_{in_Overshoot}$	$V_{in}=24V$, Dim=3.3V (After turn on)	-	3.42	3.51	A_{mean}
	$I_{in_Saturation}$	$V_{in}=24V$, Dim=3.3V (After 1hr aging)	-	3.27	3.36	

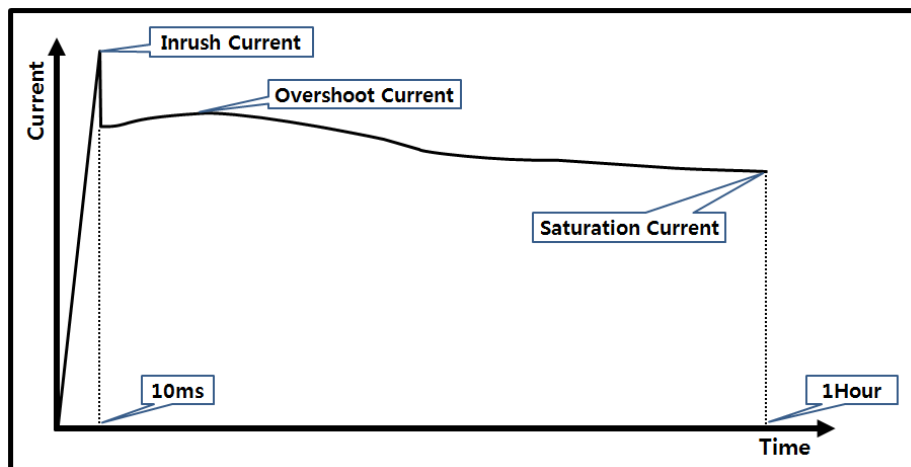

5. INPUT TERMINAL PIN ASSIGNMENT

5.1 INPUT SIGNAL & POWER

Connector : PF050-O51B-C20-F(UJU)

PIN No.	Description		PIN No.	Description	
1	V _{DD} (12V)		26	Even LVDS Signal	Rx2[A]P
2	V _{DD} (12V)		27		Rx2[B]N
3	V _{DD} (12V)		28		Rx2[B]P
4	V _{DD} (12V)		29		Rx2[C]N
5	V _{DD} (12V)		30		Rx2[C]P
6	No Connection (1)		31		GND
7	GND		32		Rx2CLK_N
8	GND		33		Rx2CL_P
9	GND		34		GND
10	Odd LVDS Signal	Rx1[A]N	35		Rx2[D]N
11		Rx1[A]P	36	Rx2[D]P	
12		Rx1[B]N	37	No Connection (1)	
13		Rx1[B]P	38	No Connection (1)	
14		Rx1[C]N	39	GND	
15		Rx1[C]P	40	No Connection (1)	
16		GND	41	No Connection (1)	
17		Rx1CLK_N	42	No Connection (1)	
18		Rx1CLK_P	43	No Connection (1)	
19		GND	44	No Connection (1)	
20		Rx1[D]N	45	LVDS_SEL (2)	
21		Rx1[D]P	46	No Connection (1)	
22		No Connection (1)	47	No Connection (1)	
23		No Connection (1)	48	No Connection (1)	
24	GND		49	No Connection (1)	
25	Even LVDS	Rx2[A]N	50	No Connection (1)	
			51	No Connection (1)	

Note(1) No Connection : These pins are only used for SAMSUNG internal purpose.

Note(2) LVDS Option : High(3.3V) → Normal NS LVDS format

Low(GND or N.C) → JEIDA LVDS format

Sequence : On = V_{DD}(T1) ≥ LVDS Option ≥ Interface Signal(T2)

Off = Interface Signal(T3) ≥ LVDS Option ≥ V_{DD}

Note(3) LVDS Connector

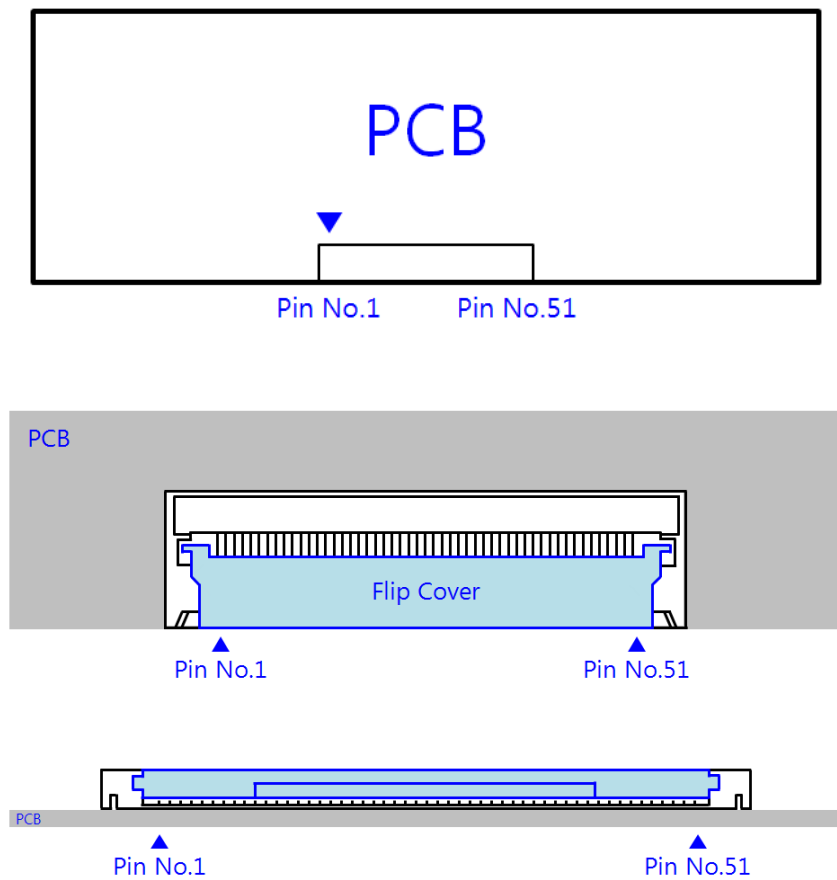

- a. All GND pins should be connected together and also be connected to the LCD's metal chassis.
- b. All power input pins should be connected together.
- c. All N.C pins should be separated from other signal or power.

5.2 LED CONVERTER INPUT PIN CONFIGURATION

Connector : YEONHO, 22022WR-H14B2

PIN NO	Pin Configuration(FUNCTION)
1	V _{in} (24V)
2	V _{in} (24V)
3	V _{in} (24V)
4	V _{in} (24V)
5	V _{in} (24V)
6	GND
7	GND
8	GND
9	GND
10	GND
11	No Connection
12	ENA (Converter On/Off control signal) Off : -0.3~0.4V / On : 2.4~5.25V
13	Analog Dimming control (0V : Min, 3.3V : Max)
14	No Connection

5.3 LED CONVERTER POWER SEQUENCE

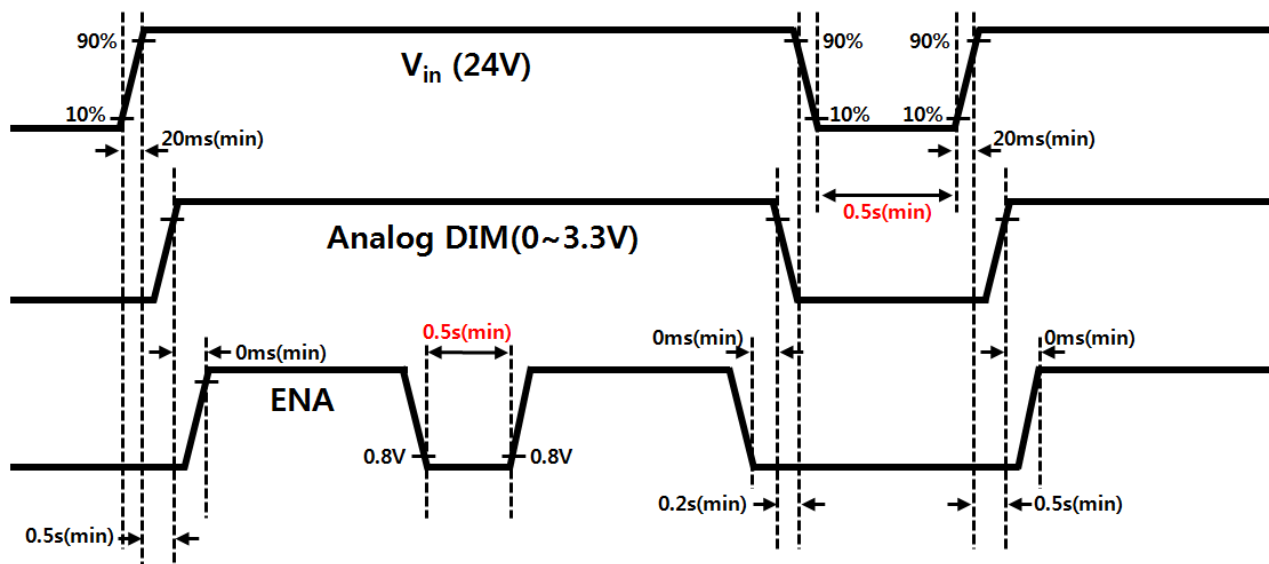

5.4 LVDS INTERFACE

- LVDS Receiver : Tcon(Merged)
- Data Format (JEIDA & Normal)

Default LVDS Option : JEIDA

	LVDS pin	JEIDA -DATA	VESA -DATA
TxOUT/RxIN0	TxIN/RxOUT0	R2	R0
	TxIN/RxOUT1	R3	R1
	TxIN/RxOUT2	R4	R2
	TxIN/RxOUT3	R5	R3
	TxIN/RxOUT4	R6	R4
	TxIN/RxOUT6	R7	R5
	TxIN/RxOUT7	G2	G0
TxOUT/RxIN1	TxIN/RxOUT8	G3	G1
	TxIN/RxOUT9	G4	G2
	TxIN/RxOUT12	G5	G3
	TxIN/RxOUT13	G6	G4
	TxIN/RxOUT14	G7	G5
	TxIN/RxOUT15	B2	B0
	TxIN/RxOUT18	B3	B1
TxOUT/RxIN2	TxIN/RxOUT19	B4	B2
	TxIN/RxOUT20	B5	B3
	TxIN/RxOUT21	B6	B4
	TxIN/RxOUT22	B7	B5
	TxIN/RxOUT24	HSYNC	HSYNC
	TxIN/RxOUT25	VSYNC	VSYNC
	TxIN/RxOUT26	DEN	DEN
TxOUT/RxIN3	TxIN/RxOUT27	R0	R6
	TxIN/RxOUT5	R1	R7
	TxIN/RxOUT10	G0	G6
	TxIN/RxOUT11	G1	G7
	TxIN/RxOUT16	B0	B6
	TxIN/RxOUT17	B1	B7
	TxIN/RxOUT23	RESERVED	RESERVED

LVDS Option : High(3.3V) → Normal NS LVDS format / Low(GND or N.C) → JEIDA LVDS format

5.5 INPUT SIGNALS, BASIC DISPLAY COLORS AND GRAY SCALE

COLOR	DISPLAY (8bit)	DATA SIGNAL																												GRAY SCALE LEVEL
		RED								GREEN								BLUE												
		R0	R1	R2	R3	R4	R5	R6	R7	G0	G1	G2	G3	G4	G5	G6	G7	B0	B1	B2	B3	B4	B5	B6	B7					
BASIC COLOR	BLACK	0	0	0	0	0	0	0	0	0	0	0	0	0	0	0	0	0	0	0	0	0	0	0	0	0	0	0	-	
	BLUE	0	0	0	0	0	0	0	0	0	0	0	0	0	0	0	0	1	1	1	1	1	1	1	1	1	1	1	-	
	GREEN	0	0	0	0	0	0	0	0	1	1	1	1	1	1	1	1	0	0	0	0	0	0	0	0	0	0	0	-	
	CYAN	0	0	0	0	0	0	0	0	1	1	1	1	1	1	1	1	1	1	1	1	1	1	1	1	1	1	1	-	
	RED	1	1	1	1	1	1	1	1	0	0	0	0	0	0	0	0	0	0	0	0	0	0	0	0	0	0	0	-	
	MAGENTA	1	1	1	1	1	1	1	1	0	0	0	0	0	0	0	0	1	1	1	1	1	1	1	1	1	1	1	-	
	YELLOW	1	1	1	1	1	1	1	1	1	1	1	1	1	1	1	1	0	0	0	0	0	0	0	0	0	0	0	-	
	WHITE	1	1	1	1	1	1	1	1	1	1	1	1	1	1	1	1	1	1	1	1	1	1	1	1	1	1	1	-	
GRAY SCALE OF RED	BLACK	0	0	0	0	0	0	0	0	0	0	0	0	0	0	0	0	0	0	0	0	0	0	0	0	0	0	R0		
	DARK ↑	1	0	0	0	0	0	0	0	0	0	0	0	0	0	0	0	0	0	0	0	0	0	0	0	0	0	R1		
		0	1	0	0	0	0	0	0	0	0	0	0	0	0	0	0	0	0	0	0	0	0	0	0	0	0	R2		
		:	:	:	:	:	:	:	:	:	:	:	:	:	:	:	:	:	:	:	:	:	:	:	:	:	:	R3~R252		
	↓ LIGHT	:	:	:	:	:	:	:	:	:	:	:	:	:	:	:	:	:	:	:	:	:	:	:	:	:	:			
		1	0	1	1	1	1	1	1	0	0	0	0	0	0	0	0	0	0	0	0	0	0	0	0	0	0	R253		
	0	1	1	1	1	1	1	1	1	0	0	0	0	0	0	0	0	0	0	0	0	0	0	0	0	0	0	R254		
	RED	1	1	1	1	1	1	1	1	0	0	0	0	0	0	0	0	0	0	0	0	0	0	0	0	0	0	R255		
GRAY SCALE OF GREEN	BLACK	0	0	0	0	0	0	0	0	0	0	0	0	0	0	0	0	0	0	0	0	0	0	0	0	0	0	G0		
	DARK ↑	0	0	0	0	0	0	0	0	1	0	0	0	0	0	0	0	0	0	0	0	0	0	0	0	0	0	G1		
		0	0	0	0	0	0	0	0	0	1	0	0	0	0	0	0	0	0	0	0	0	0	0	0	0	0	G2		
		:	:	:	:	:	:	:	:	:	:	:	:	:	:	:	:	:	:	:	:	:	:	:	:	:	:	G3~G252		
	↓ LIGHT	:	:	:	:	:	:	:	:	:	:	:	:	:	:	:	:	:	:	:	:	:	:	:	:	:	:			
		0	0	0	0	0	0	0	0	1	0	1	1	1	1	1	1	0	0	0	0	0	0	0	0	0	0	G253		
	0	0	0	0	0	0	0	0	0	0	1	1	1	1	1	1	1	0	0	0	0	0	0	0	0	0	0	G254		
	GREEN	0	0	0	0	0	0	0	0	1	1	1	1	1	1	1	1	0	0	0	0	0	0	0	0	0	0	G255		
GRAY SCALE OF BLUE	BLACK	0	0	0	0	0	0	0	0	0	0	0	0	0	0	0	0	0	0	0	0	0	0	0	0	0	0	B0		
	DARK ↑	0	0	0	0	0	0	0	0	0	0	0	0	0	0	0	0	1	0	0	0	0	0	0	0	0	0	B1		
		0	0	0	0	0	0	0	0	0	0	0	0	0	0	0	0	0	1	0	0	0	0	0	0	0	0	B2		
		:	:	:	:	:	:	:	:	:	:	:	:	:	:	:	:	:	:	:	:	:	:	:	:	:	:	B3~B252		
	↓ LIGHT	:	:	:	:	:	:	:	:	:	:	:	:	:	:	:	:	:	:	:	:	:	:	:	:	:	:			
		0	0	0	0	0	0	0	0	0	0	0	0	0	0	0	0	1	0	1	1	1	1	1	1	1	1	B253		
	0	0	0	0	0	0	0	0	0	0	0	0	0	0	0	0	0	0	1	1	1	1	1	1	1	1	1	B254		
	BLUE	0	0	0	0	0	0	0	0	0	0	0	0	0	0	0	0	1	1	1	1	1	1	1	1	1	1	B255		

Note) Definition of Gray

Rn : Red Gray, Gn : Green Gray, Bn : Blue Gray(n = Gray Level)

Input Signal : 0 = Low Level Voltage, 1 = High Level Voltage

6. INTERFACE TIMING

6.1 TIMING PARAMETERS (DE ONLY MODE)

SIGNAL	ITEM	SYMBOL	MIN	TYP	MAX	Unit	NOTE
Clock	Frequency	$1/T_C$	130	148.5	152.5	MHz	-
Hsync		F_H	54	67.5	69.75	KHz	-
Vsync		F_V	48	60	62.5	Hz	-
Term for the vertical display	Active display period	T_{VD}	-	1080	-	Lines	-
	Total vertical	T_V	1100	1125	1158	Lines	-
Term for the horizontal display	Active display period	T_{HD}	-	1920	-	Clocks	-
	Total Horizontal	T_H	2090	2200	2350	clocks	-

Note) The signals of Hsync and Vsync must be inputted even though this T-con is operated at DE mode.

- (1) Test Point: TTL controls signal and CLK at LVDS Tx at the input terminal of system.
- (2) Internal VDD = 3.3V
- (3) The spread spectrum
 - The limit of spread spectrum's range of SET in which the LCD module is assembled should be within $\pm 3\%$
 - Frequency for modulation : Min 30KHz ~ Max 300KHz

6.2 TIMING DIAGRAMS OF INTERFACE SIGNAL (DE ONLY MODE)

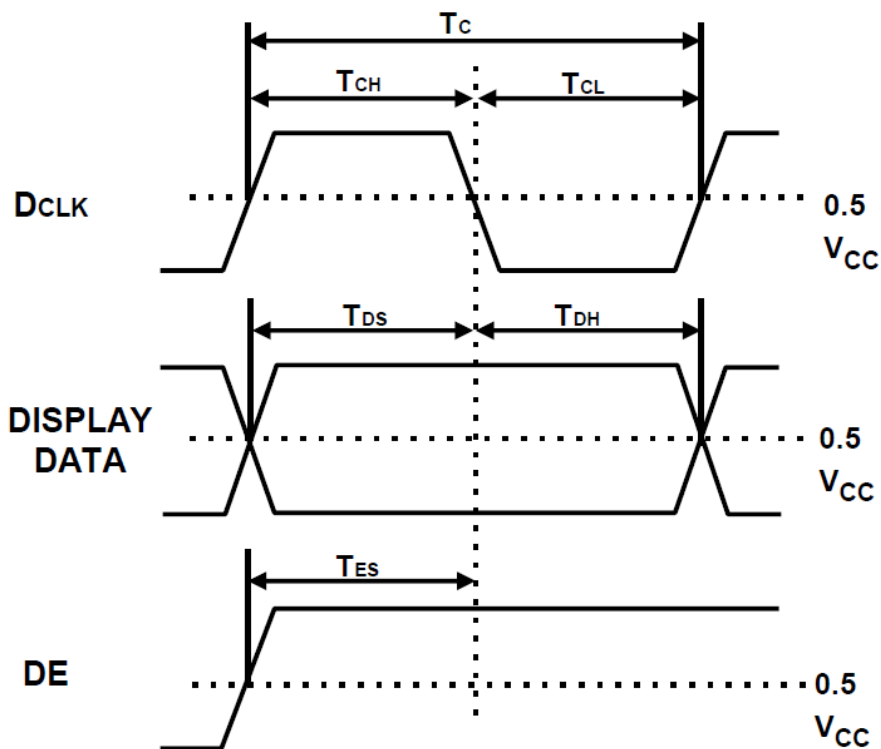
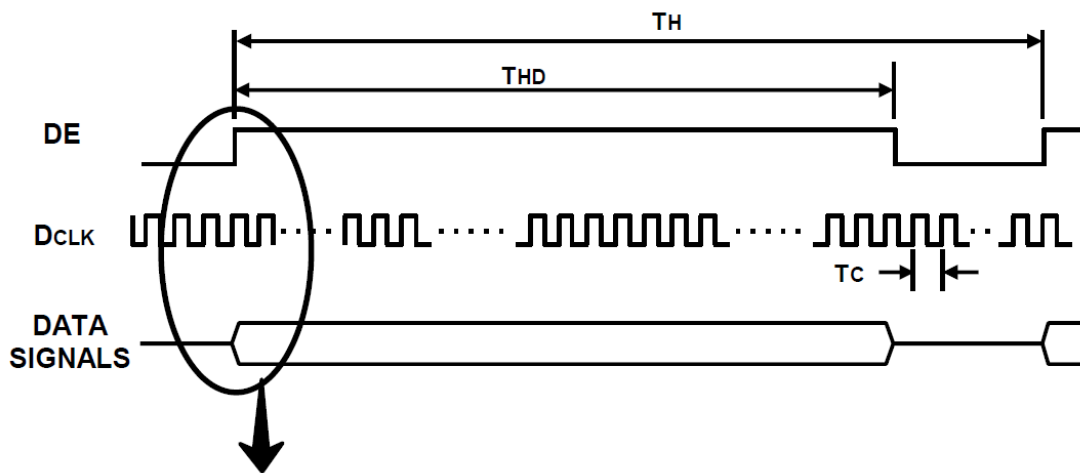
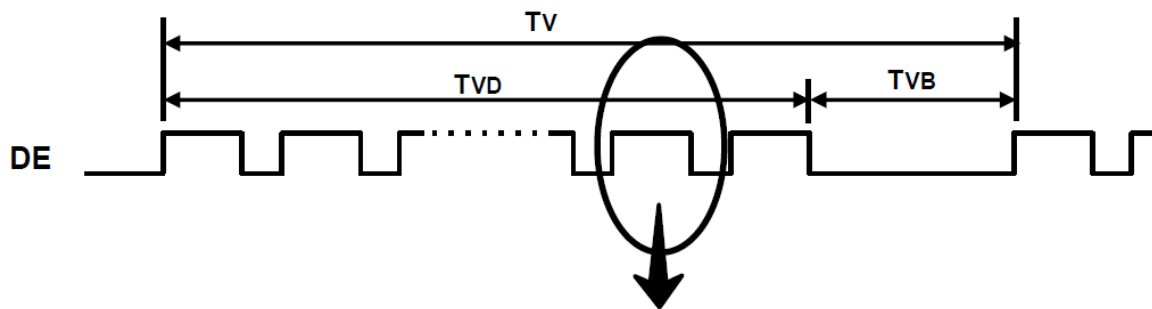

6.3 CHARACTERISTICS OF INPUT DATA OF LVDS

(1) Specification for DC

ITEM	SYMBOL	Min	Typ	Max	UNIT
Supply voltage for IO	VDD33_LVDS	3.0	3.3	3.6	V
Supply voltage in the core	VDD12_LVDS	1.1	1.2	1.3	V
Color depth	-	-	8	-	Bit
Input voltage at the common mode	V_{CM}	0.3	-	1.8	V
Input voltage for differential	$ V_{ID} $	100	350	600	mV

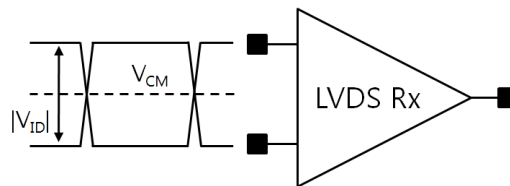

(2) Specification for AC

ITEM	SYMBOL	Min.	Typ.	Max.	UNIT	
Frequency for input clock (=1/T)	f_{IN}	25	-	90	MHz	
Period of output clock	t_{RCP}	11.11	-	40	ns	
Position of input data	FIN=85MHZ	t_{RSRM}	-	-	+400	ps
	FIN=78MHZ		-	-	+450	
	FIN=75MHZ		-	-	+500	
Position of input data	FIN=85MHZ	t_{RSLM}	-400	-	-	ps
	FIN=78MHZ		-450	-	-	
	FIN=75MHZ		-500	-	-	
Lock time	t_{RPLL}	-	-	100	usec	
Duty ratio of Rx's clock for output	T_{duty}	45	50	55	%	

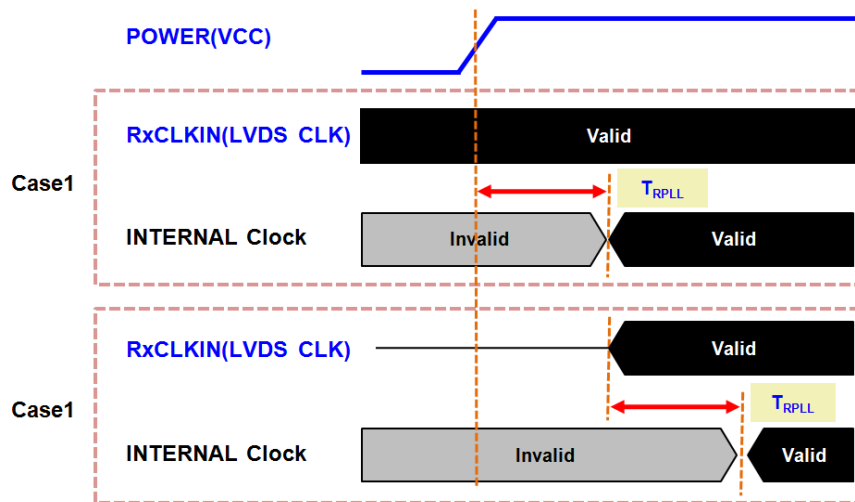
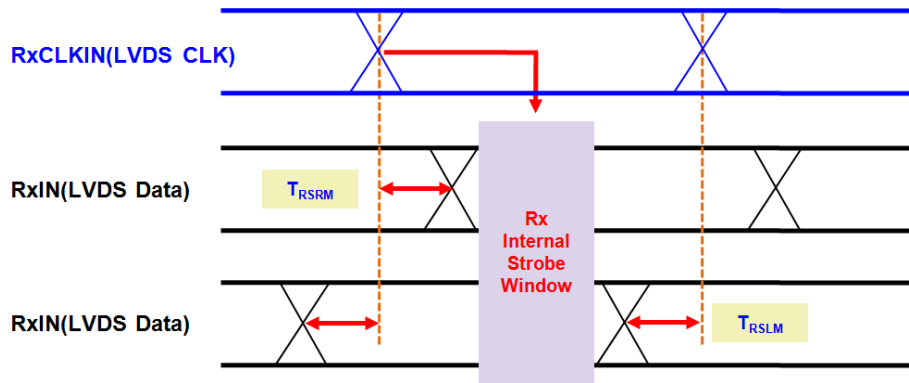

* LVDS Channel to Channel Skew(T_{chskw}) in Multiple LVDS Channels

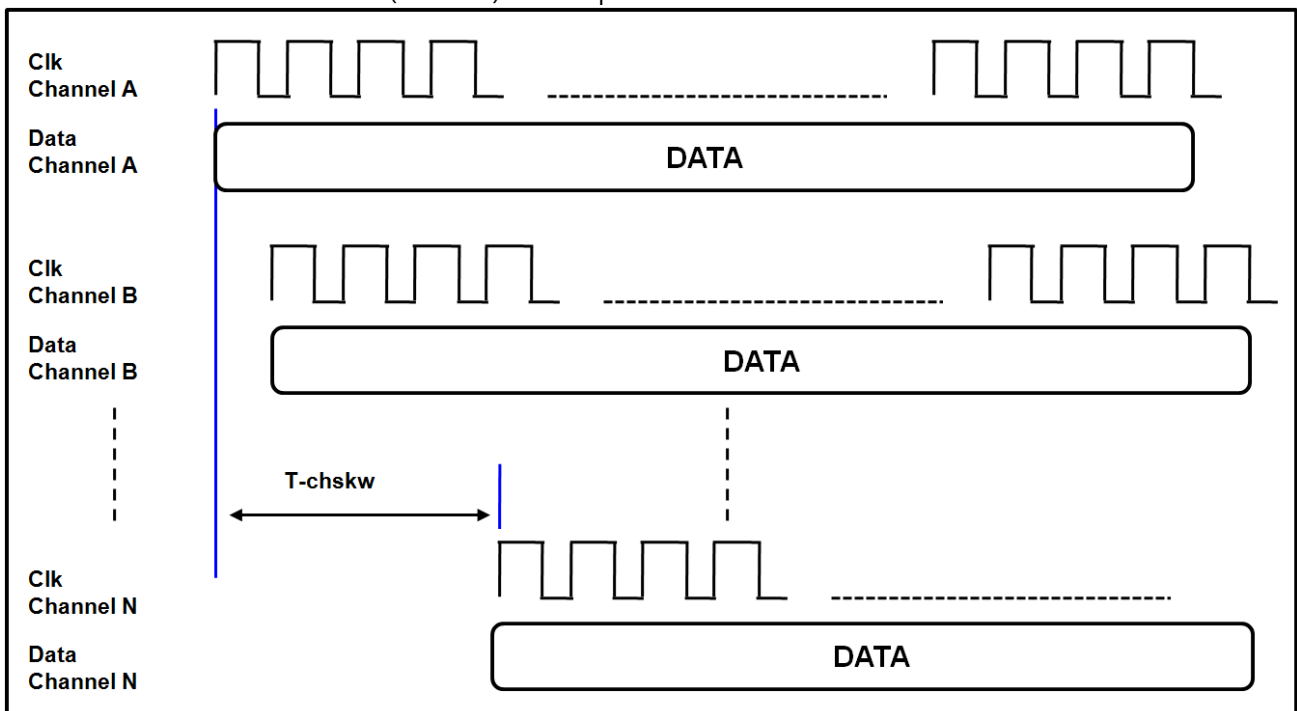

Note : DE should be synchronized with DE per each LVDS Channel and $T_{chskw} < 16 * \text{LVDS Clock Period}$

6.4 THE SEQUENCE OF POWER ON AND OFF

To prevent the product from being latched up or the DC in the LCD module from starting an operation, the order to turn the power on and off should be changed to the order as shown in the diagram below.

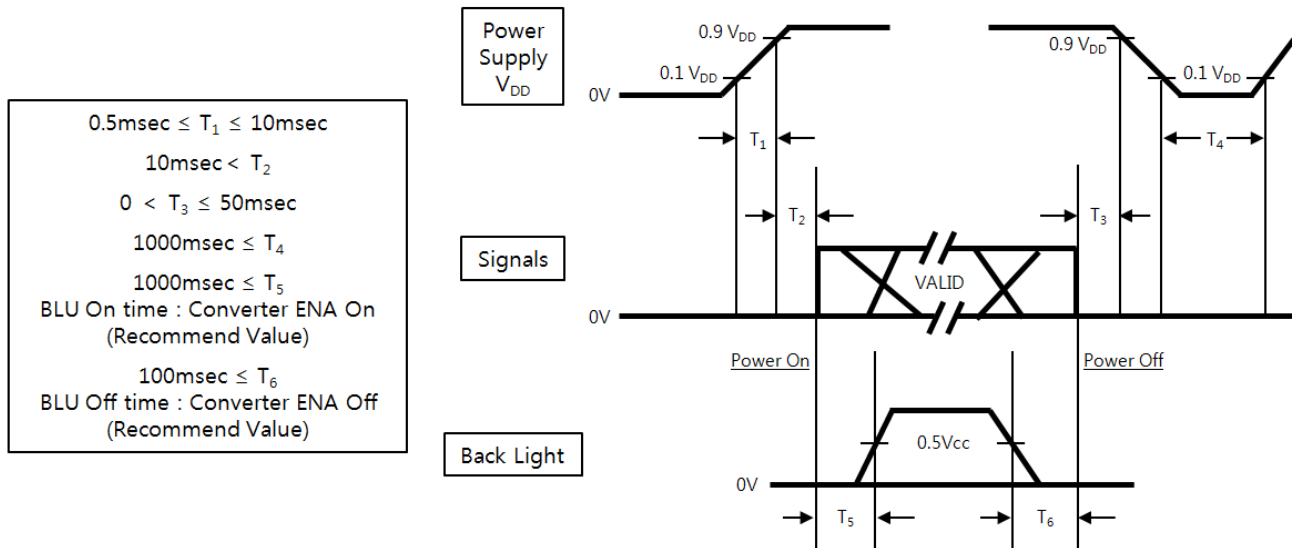

Timing	Remarks
T ₁	The time, during which the level of V _{DD} is rising from 10% to 90%.
T ₂	The changing time, during which the V _{DD} starts rising beyond 90% until the valid data of signal started coming in.
T ₃	The changing time, during which the valid data of signal starts leaving out until the V _{DD} starts falling below 90%.
T ₄	The changing time, during which the V _{DD} starts falling below 10% to restart the Windows.
T ₅	The changing time, during which the signal of BLU starts rising beyond 50%.
T ₆	The changing time, during which the signal of BLU starts falling below 50%.

- The inputted V_{DD} 's value for supply voltage, BLU, and signal to the external system of the module shall be computed with referring to the former mentioned value.
- The method to apply the voltage to the LED within the range, which the LCD operates. When the back-light is turned on before the LCD is operated or the power of LCD is turned off before the back-light is turned off, the abnormal display on the screen may be shown momentarily.
- Please keep the level of input signal low or keep the level of impedance high when the value of V_{DD} is below 10%.
- The value shall be measured after the module has been fully discharged between the period, which the power is turned on and the period, which the power is turned off like the T4 timing. The backlight may be flashed if the interface signal remains floated when the above-mentioned signal becomes invalid.

7. OUTLINE DIMENSION

Please refer next 2pages.

NO	PART NAME	CODE NO	SPECIFICATION	QTY	SPEC NO	REMARK
1	OUTLINE DIMENSION	-	LTI460HN0-V	1		

SAMSUNG CONFIDENTIAL

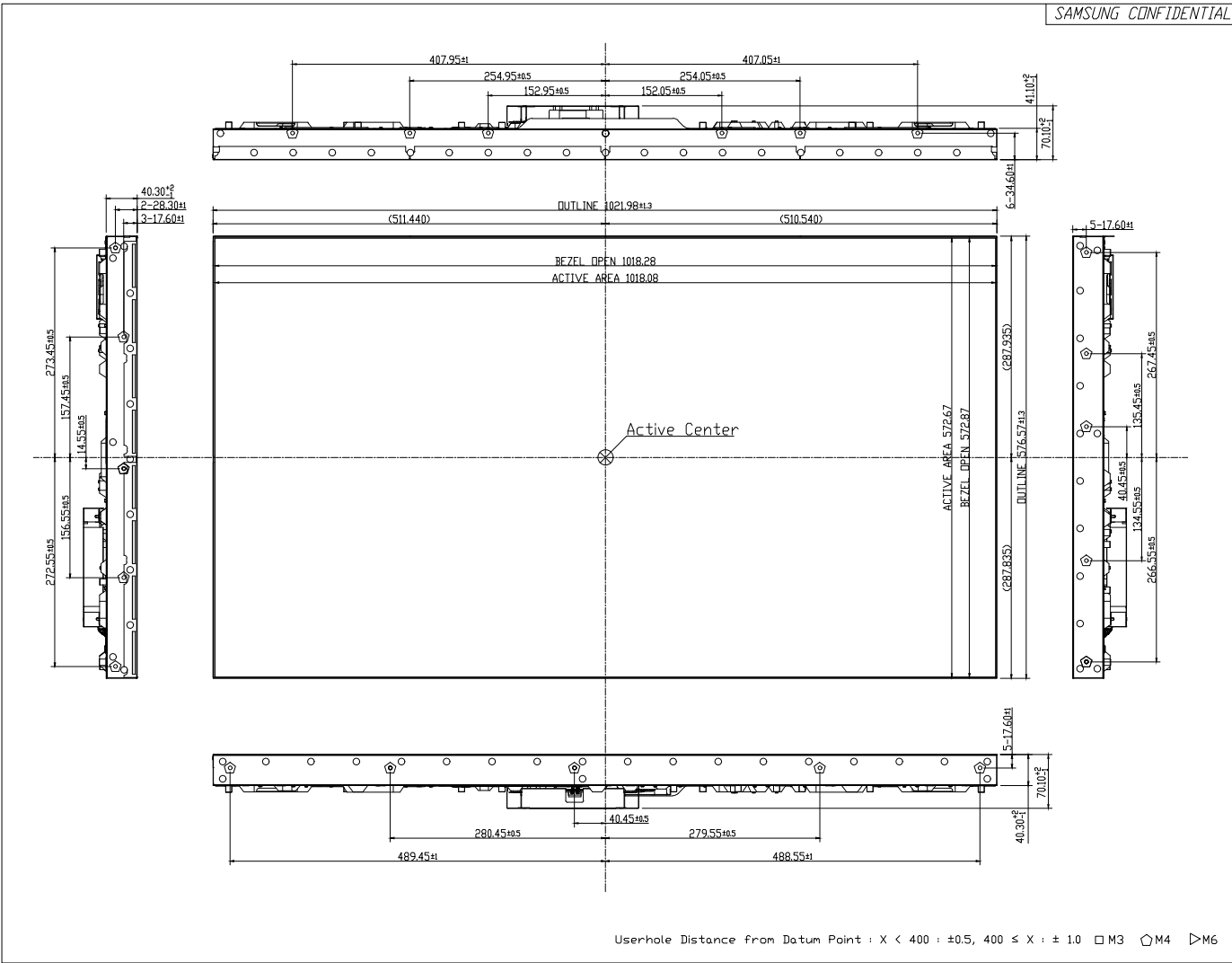

- * NOTE
- BACKLIGHT : WLED (Direct type)
 - I/F CONNECTOR SPECIFICATION (SIPIN)
 - MAKER : YEONHO
 - PART NO. : 05002HR-HANNS(G)
 - CONVERTER CONNECTOR SPECIFICATION(14PIN, IEA)
 - MAKER : YEONHO
 - PART NO. : 20022WR-14B2
 - USER HOLE
 - ALLOWED SCREW TORQUE
 - > M4 TAP : 6.0Kgf.cm MAX
 - > M5 TAP : 8.0Kgf.cm MAX
 - ALLOWED DEPTH OF USER TORQUE SCREW INSERTION IS 6.0MM MAX
 - CHASSIS-TOP AND PUL GAP : MAX 1.5mm
 - WEIGHT : 12.5kg (MAX)

Userhole Distance from Datum Point : $X < 400 : \pm 0.5$, $400 \leq X : \pm 1.0$ □ M3 ○ M4 ▷ M6

REF

GENERAL TOLERANCE				REV	DATE	DESCRIPTION OF REVISION			REASON		CHK'D BY	
DISTANCE	LEVEL 1	LEVEL 2	LEVEL 3	UNIT	DRWN BY	DES'D BY	CHK'D BY	APP'D BY	MODEL NAME	OUTLINE DIM(FRONT)	SHEET	L/PZ
0 < X ≤ 6	± 0.05	± 0.1	± 0.2	mm					LTI460HN0-V			
6 < X ≤ 30	± 0.1	± 0.2	± 0.5	mm								
30 < X ≤ 100	± 0.15	± 0.3	± 0.8	mm								
100 < X ≤ 400	± 0.2	± 0.5	± 1.2	mm								
400 < X ≤ 1000	± 0.3	± 0.8	± 2.0	mm								
				SCALE	SAMSUNG DISPLAY			SPEC. NO.		CODE NO.	VER.	000

8. RELIABILITY TEST

Item	Test condition	Quantity
HTOL	50℃, 500hr determination	8EA
LTOL	0℃, 500hr determination	4EA
HTS	70℃, 500hr determination	4EA
LTS	-25℃, 500hr determination	4EA
THB	50℃ / 90%RH, 500hr determination	10EA
WHTS	60℃ / 75%RH, 500hr determination	4EA
T/S	-20 ~ 60℃, Dwell time : 60Min, 200cycle	4EA
TSS	-20 ~ 65℃, 220cycle	4EA
Image sticking	50℃, Mosaic pattern (9X10), 168hrs	8EA
Contact ESD	±10 kV, 210Point, 1 time/Point	3EA
Air ESD	±20 kV, 210Point, 1 time/Point	3EA
Input Con. ESD	±15kV, Input Con. Pin, 3 times/Pin	3EA
Dust	5sec spray, 5min sedimentation / 10hr Power 10min on, 10min off	2EA
Pallet Vibration → Pallet Drop	Pallet vibration : 1.05Grms, 5 ~ 200Hz, 2hr/stack side Pallet Drop : 20cm, bottom side 2 angles, 1side(Bottom)	2Pallet
Altitude	-40~50℃, 0m(0ft) ~ 13,700m(45,000ft), 72.5Hr	4EA

* SDC don't guarantee about Module vibration and shock of LTI460HN11-0 due to UNB's characteristic.

[Criteria on evaluation]

The components of product, which may affect to the function of display shall not be changed when the display quality test is executed under the normal operating condition.

* HTOL / LTOL : The operating at the high and low temperature

* THB : The slant of temperature and humidity

* HTS / LTS : The storage at the high and low temperature

* WHTS : The storage condition at the high temperature with the high humidity

9. PACKING

(1) Packing Form : EPS Cushion / Paper Box

(2) Packing Method

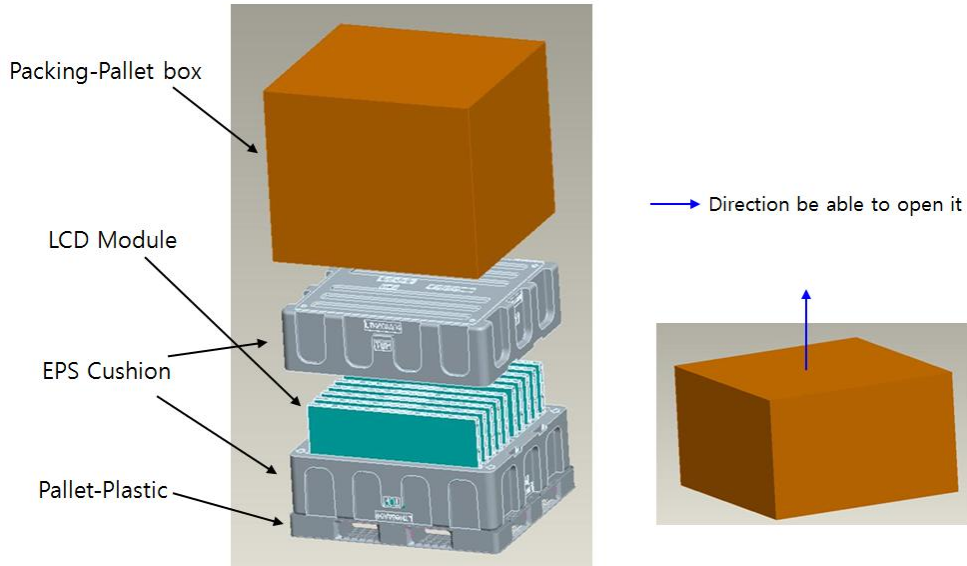

Note(1) Total Weight : Approximately 144kg [With Pallet-Plastic]

Note(2) Acceptance number of piling : Move – 1Pallet, Stock - 2 Pallets

Note(3) Carton size : 1256mm(H) x 1136mm(V) x 723mm(Height) [Without Pallet Plastic]
 1270mm(H) x 1150mm(V) x 889mm(Height) [With Pallet Plastic]

(3) Packing Material

No	Part name	Quantity
1	Packing-Pallet box	1 EA
2	EPS cushion (Top / Bottom)	2 EA
3	Bag-Shielding	8 EA
4	Protector-Panel	8 EA
5	Pallet-Plastic	1 EA

10. MARKINGS & OTHERS

A nameplate bearing followed by is affixed to a shipped product at the specified location on each product.

(1) Parts number : LTI460HN11

(2) Revision code : 0XX(Three letters)

(3) Lot number : X X X X XXX XX X

- Cell Position No. (In the Glass)
- Glass No. (In the one Lot)
- Lot No. (Glass)
- Month
- Year
- Product code
- Line

(4) Nameplate Indication

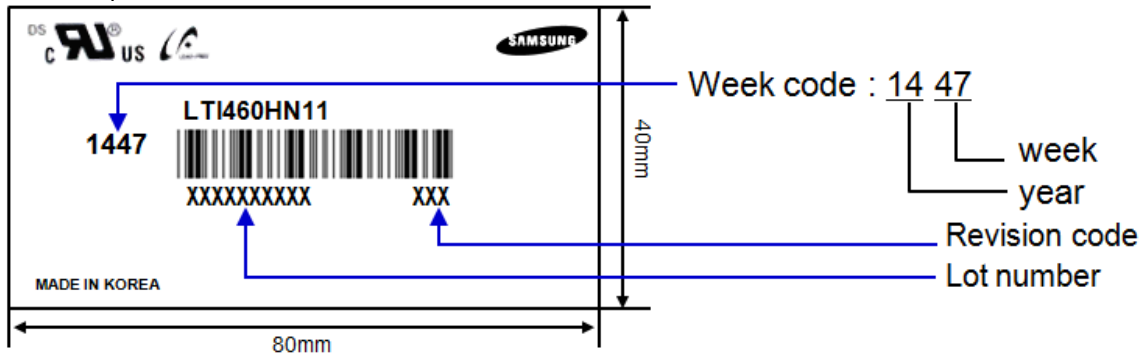

(5) Landscape / Portrait Direction Indication

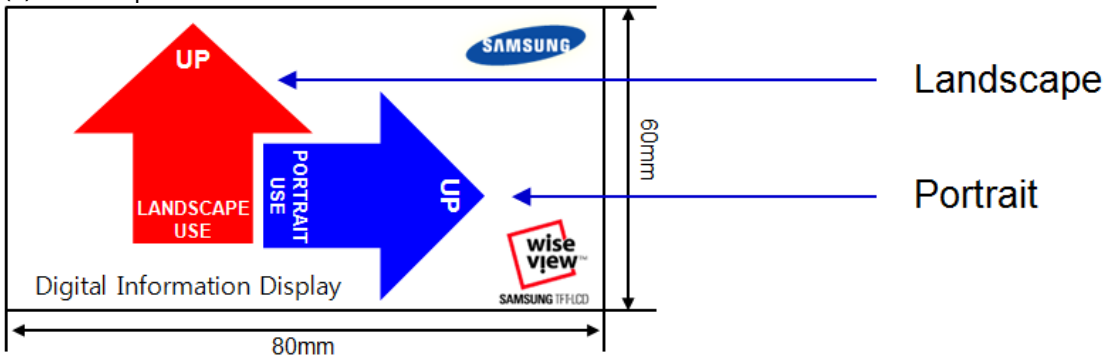

(6) Packing small box attach

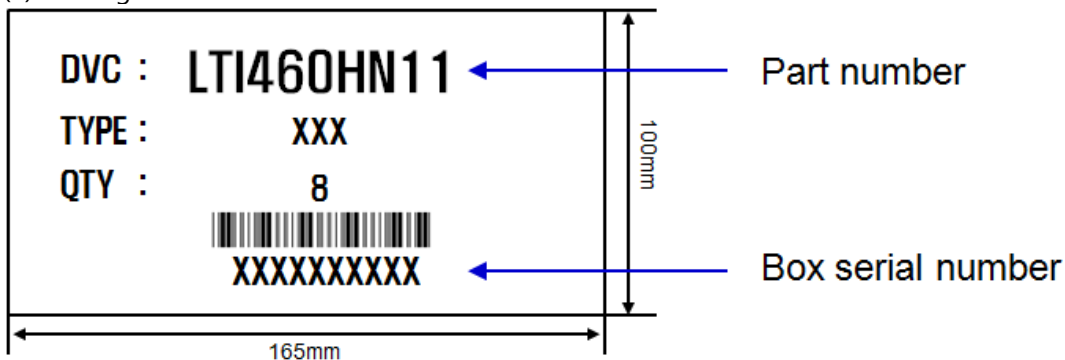

11. GENERAL PRECAUTIONS

11.1 HANDLING

- (a) When the module is assembled, It should be attached to the system firmly using every mounting holes. Be careful not to twist and bend the modules.
- (b) Refrain from strong mechanical shock and / or any force to the module. In addition to damage, this may cause improper operation or damage to the module and LED back-light.
- (c) Note that polarizers are very fragile and could be easily damaged. Do not press or scratch the surface harder than a HB pencil lead.
- (d) Wipe off water droplets or oil immediately. If you leave the droplets for a long time, Staining and discoloration may occur.
- (e) If the surface of the polarizer is dirty, clean it using some absorbent cotton or soft cloth.
- (f) The desirable cleaners are water, IPA (Isopropyl Alcohol) or Hexane. Do not use Ketone type materials (ex. Acetone), Ethyl alcohol, Toluene, Ethyl acid or Methyl chloride. It might permanent damage to the polarizer due to chemical reaction.
- (g) If the liquid crystal material leaks from the panel, it should be kept away from the eyes or mouth. In case of contact with hands, legs or clothes, it must be washed away thoroughly with soap.
- (h) Protect the module from static. it may cause damage to the C-MOS Gate Array IC.
- (i) Use fingerstalls with soft gloves in order to keep display clean during the incoming inspection and assembly process.
- (j) Do not disassemble the module.
- (k) Do not pull or fold the LED wire.
- (l) Do not touch any component which is located on the back side.
- (m) Protection film for polarizer on the module shall be slowly peeled off just before use so that the electrostatic charge can be minimized.
- (n) Pins of I/F connector shall not be touched directly with bare hands.

11.2 STORAGE

We highly recommend to comply with the criteria in the table below.

ITEM	Unit	Min.	Max.
Storage Temperature	(°C)	5	40
Storage Humidity	(%rH)	35	75
Storage Life	12 months		
Storage Condition	- The storage room should be equipped with a good ventilation facility, which has a temperature controlling system. - Products should be placed on the pallet, which is away from the wall not on the floor. - Prevent products from being exposed to the direct sunlight, moisture, and water. Be cautious not to pile the products up. - Avoid storing products in the environment, which other hazardous material is placed. - If products are delivered or kept in the storage facility more than 3 months, we recommend you to leave products under the condition including a 20°C temperature and a humidity of 50% for 24 hours. - If you store semi-manufactured products for more than 3 months, bake the products under the condition including the 50°C temp. and the 10% humidity for 24hrs after being used.		

11.3 OPERATION

- (a) Do not connect or disconnect the cable to/ from the module at the "Power On" condition.
- (b) The power shall be always turned on/off by the item 6.4. "Power on/off sequence"
- (c) The module has a circuit with a high frequency. The system manufacturers shall suppress the electromagnetic interference sufficiently. The methods to ground and shield are important to minimize the interference.
- (d) Design the length of cable to connect between the connector for back-light and the converter as short as possible and the shorter cable shall be connected directly.
 The longer cable between that of back-light and that of converter may cause the luminance of LED to lower and need a higher startup voltage(Vs).

11.4 OPERATION CONDITION GUIDE

- (a) The LCD product should be operated under normal conditions.
 Normal condition is defined as below;
 Temperature : 20±15°C
 Humidity : 55±20%
 Display pattern : continually changing pattern (Not stationary)
- (b) If the product will be used in extreme conditions such as high temperature, humidity, display patterns or operation time etc., It is strongly recommended to contact SDC for Application engineering advice.
 Otherwise, its reliability and function may not be guaranteed. Extreme conditions are commonly found at Airports, Transit Stations, Banks, Stock market, and Controlling systems.

11.5 OTHERS

- (a) Ultra-violet ray filter is necessary for outdoor operation.
- (b) Module should be turned clockwise (regular front view perspective) when used in portrait mode.
- (c) Avoid condensation of water. It may result in improper operation or disconnection of electrode.
- (d) Do not exceed the absolute maximum rating value. (supply voltage variation, input voltage variation, variation in part contents and environmental temperature, and so on) Otherwise the Module may be damaged.
- (e) If the Module keeps displaying the same pattern for a long period of time, the image may be "sticked" to the screen. To avoid image sticking, it is recommended to use a screen saver.
- (f) This Module has its circuitry PCB's on the rear side and should be handled carefully in order not to be stressed.
- (g) Please contact SDC in advance when you display the same pattern for a long time.