

Applications

- Military radar
- Civilian radar
- Professional and military radio communications
- Test instrumentation
- Wideband or narrowband amplifiers
- Jammers



Product Features

- Frequency: DC to 3.5 GHz
- Output Power (P_{3dB}): 64 W at 3.3 GHz
- Linear Gain: 16 dB at 3.3 GHz
- Operating Voltage: 28 V
- Low thermal resistance package

Functional Block Diagram

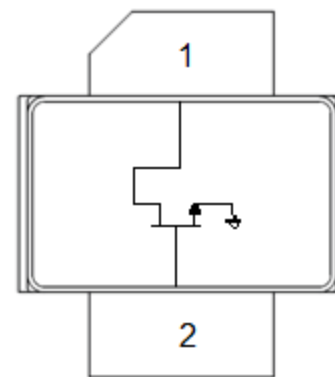

General Description

The TriQuint T2G4005528-FS is a 55 W (P_{3dB}) discrete GaN on SiC HEMT which operates from DC to 3.5 GHz. The device is constructed with TriQuint's proven TQGaN25 production process, which features advanced field plate techniques to optimize power and efficiency at high drain bias operating conditions. This optimization can potentially lower system costs in terms of fewer amplifier line-ups and lower thermal management costs.

Lead-free and ROHS compliant

Evaluation boards are available upon request.

Pin Configuration

Pin No.	Label
1	V_D / RF OUT
2	V_G / RF IN
Flange	Source

Ordering Information

Part	ECCN	Description
T2G4005528-FS	EAR99	Packaged part Flangeless
T2G4005528-FS-EVB1	EAR99	3.0-3.5 GHz Evaluation Board
T2G405528-FS-EVB2	EAR99	1.0 – 1.4 GHz Evaluation Board

Absolute Maximum Ratings⁽¹⁾

Parameter	Value
Breakdown Voltage ($V_{D(G)}$)	100 V (Min.) ⁽²⁾
Drain Gate Voltage ($V_{D(G)}$)	40 V
Gate Voltage Range (V_G)	-7 to 0 V
Drain Current (I_D)	20 A
Gate Current (I_G)	-20 to 56 mA
Power Dissipation (P_D)	90 W
RF Input Power, CW, $T = 25^\circ\text{C}$ (P_{IN})	43 dBm
Channel Temperature (T_{CH})	275 °C
Mounting Temperature (30 Seconds)	320 °C
Storage Temperature	-40 to 150 °C

1. Operation of this device outside the parameter ranges given above may cause permanent damage. These are stress ratings only, and functional operation of the device at these conditions is not implied.
2. Established at $V_{GS} = -8\text{V}$ and $I_{DQ} = 20\text{mA}$

Recommended Operating Conditions

Parameter	Value
Drain Voltage (V_D)	28 V (Typ.)
Drain Quiescent Current (I_{DQ})	200 mA (Typ.)
Peak Drain Current (I_D)	4.0 A (Typ.)
Gate Voltage (V_G)	-2.95 V (Typ.)
Channel Temperature (T_{CH})	225 °C (Max)
Power Dissipation, CW (P_D)	66 (Max)
Power Dissipation, Pulse (P_D)	70 (Max)

Electrical specifications are measured at specified test conditions. Specifications are not guaranteed over all recommended operating conditions.

RF Characterization – Load Pull Performance at 3.0 GHz⁽¹⁾

Test conditions unless otherwise noted: $T_A = 25^\circ\text{C}$, $V_D = 28\text{ V}$, $I_{DQ} = 200\text{ mA}$

Symbol	Parameter	Min	Typical	Max	Units
G_{LIN}	Linear Gain		16.8		dB
P_{3dB}	Output Power at 3 dB Gain Compression		66.0		W
DE_{3dB}	Drain Efficiency at 3 dB Gain Compression		61.0		%
PAE_{3dB}	Power-Added Efficiency at 3 dB Gain		58.4		%
G_{3dB}	Gain at 3 dB Compression		13.8		dB

Notes:

1. $V_{DS} = 28\text{ V}$, $I_{DQ} = 200\text{ mA}$; Pulse: 100 μs , 20%

RF Characterization – Load Pull Performance at 3.5 GHz⁽¹⁾

Test conditions unless otherwise noted: $T_A = 25^\circ\text{C}$, $V_D = 28\text{ V}$, $I_{DQ} = 200\text{ mA}$

Symbol	Parameter	Min	Typical	Max	Units
G_{LIN}	Linear Gain		16.7		dB
P_{3dB}	Output Power at 3 dB Gain Compression		64.5		W
DE_{3dB}	Drain Efficiency at 3 dB Gain Compression		59.2		%
PAE_{3dB}	Power-Added Efficiency at 3 dB Gain		56.7		%
G_{3dB}	Gain at 3 dB Compression		13.7		dB

Notes:

1. $V_{DS} = 28\text{ V}$, $I_{DQ} = 200\text{ mA}$; Pulse: 100 μs , 20%

RF Characterization – Performance at 3.3 GHz ^(1, 2)

Test conditions unless otherwise noted: $T_A = 25\text{ }^\circ\text{C}$, $V_D = 28\text{ V}$, $I_{DQ} = 300\text{ mA}$

Symbol	Parameter	Min	Typical	Max	Units
G_{LIN}	Linear Gain	14.0	16.0		dB
P_{3dB}	Output Power at 3 dB Gain Compression	55.0	62.5		W
DE_{3dB}	Drain Efficiency at 3 dB Gain Compression	50.0	52.0		%
PAE_{3dB}	Power-Added Efficiency at 3 dB Gain	45.0	49.0		%
G_{3dB}	Gain at 3 dB Compression	11.0	13.0		dB
V_g	Gate voltage	-3.2	-2.9	-2.5	V

Notes:

- Performance at 3.3 GHz in the 3.0 to 3.5 GHz Evaluation Board
- $V_{DS} = 28\text{ V}$, $I_{DQ} = 200\text{ mA}$; Pulse: 100 μs , 20%

Gate Leakage

Test conditions unless otherwise noted: $T_A = 25\text{ }^\circ\text{C}$, $V_{GS} = -5\text{ V}$, $V_{DS} = 28\text{ V}$

Symbol	Parameter	Min	Typical	Max	Units
I_{G-leak}	Leakage Gate Current			4	mA

RF Characterization – Mismatched Ruggedness at 3.50 GHz ⁽¹⁾

Test conditions unless otherwise noted: $T_A = 25\text{ }^\circ\text{C}$, $V_D = 28\text{ V}$, $I_{DQ} = 200\text{ mA}$

Symbol	Parameter	Typical
VSWR	Impedance Mismatch Ruggedness	10:1

Notes:

- $V_{DS} = 28\text{ V}$, $I_{DQ} = 200\text{ mA}$, CW at P_{1dB}

Thermal and Reliability Information

Parameter	Test Conditions	Value	Units
Thermal Resistance (θ_{JC})	DC at 85 °C Case	2.1	°C/W
Channel Temperature (T_{CH})		225	°C

Notes:
 Thermal resistance measured to bottom of package

Median Lifetime

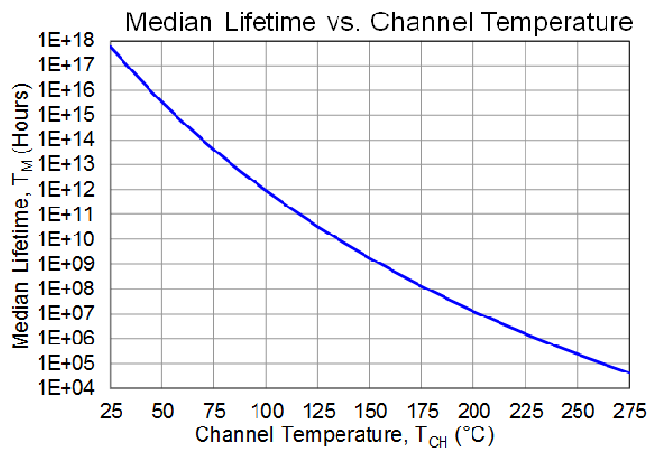

Maximum Channel Temperature

$T_{BASE} = 85^{\circ}C$, $P_D = 70 W$

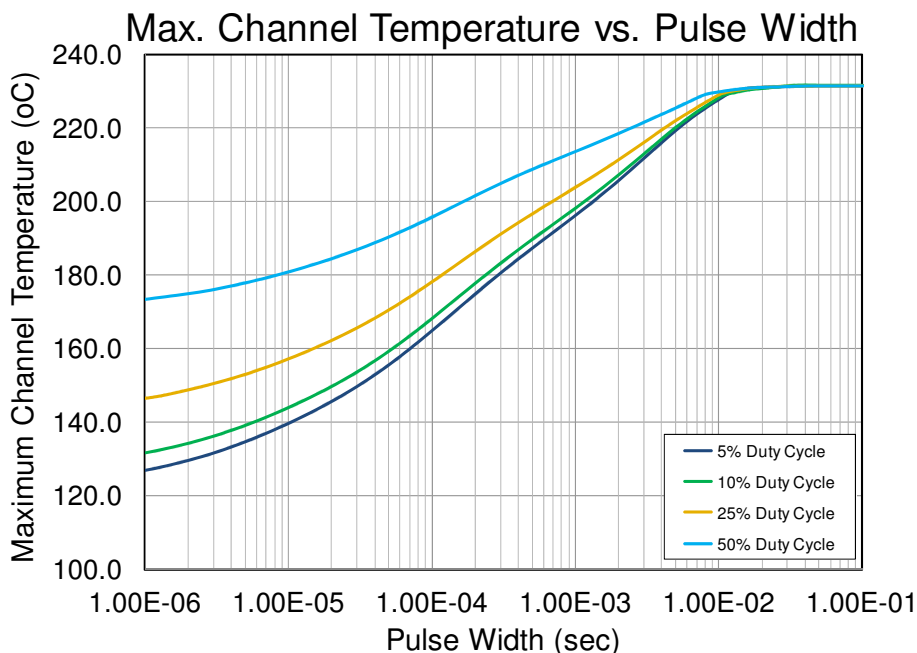

Load Pull Smith Charts (1, 2)

RF performance that the device typically exhibits when placed in the specified impedance environment. The impedances are not the impedances of the device, they are the impedances presented to the device via an RF circuit or load-pull system. The impedances listed follow an optimized trajectory to maintain high power and high efficiency.

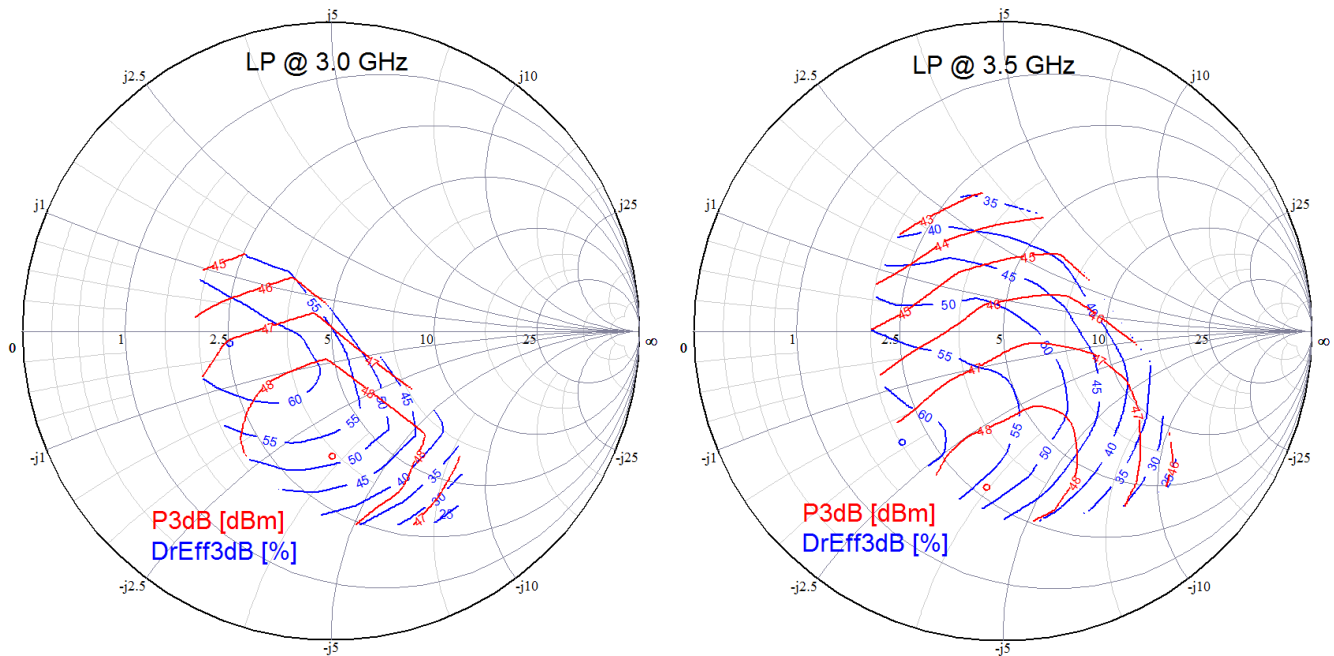

Notes:

1. Test Conditions: $V_{DS} = 28\text{ V}$, $I_{DQ} = 200\text{ mA}$
2. Test Signal: Pulse Width = 100 μsec , Duty Cycle = 20%

Typical Performance

Performance is based on compromised impedance point and measured at DUT reference plane.

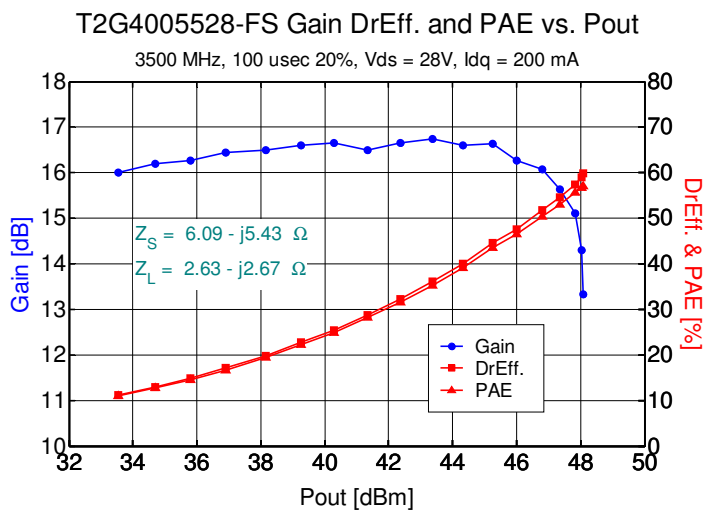
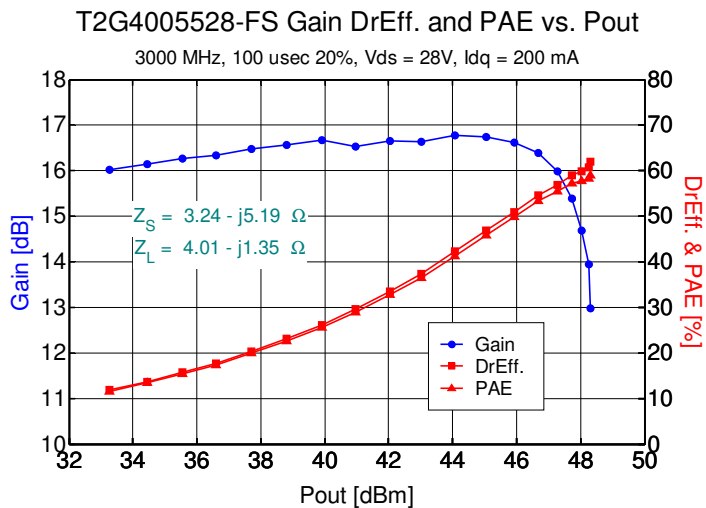

Performance Over Temperature (1, 2)

Performance measured in TriQuint's 3.0 GHz to 3.5 GHz Evaluation Board at 3 dB compression.

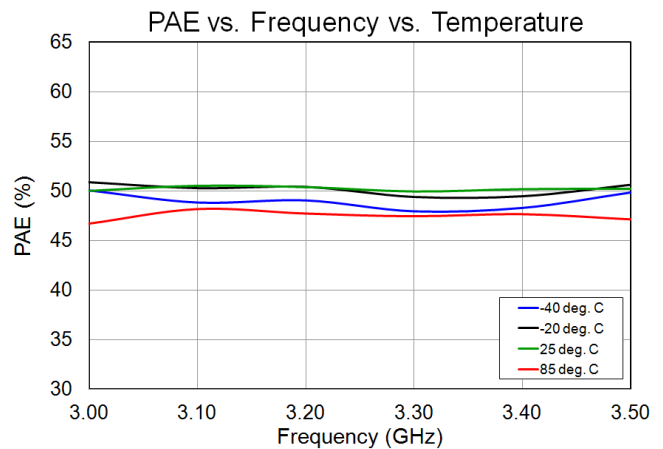
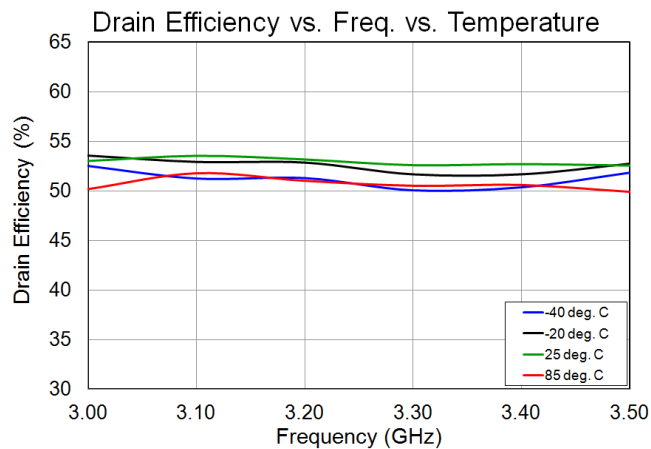
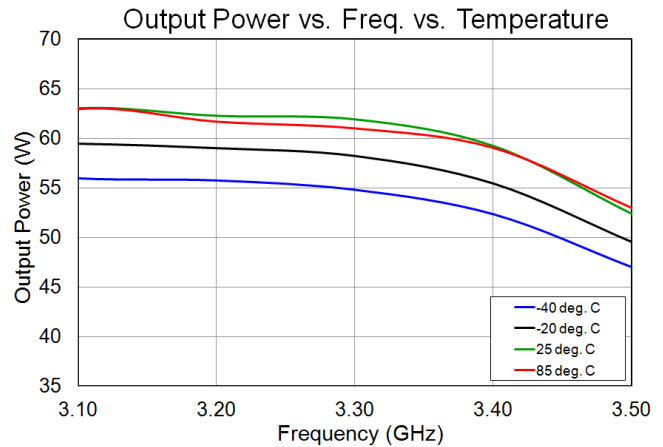
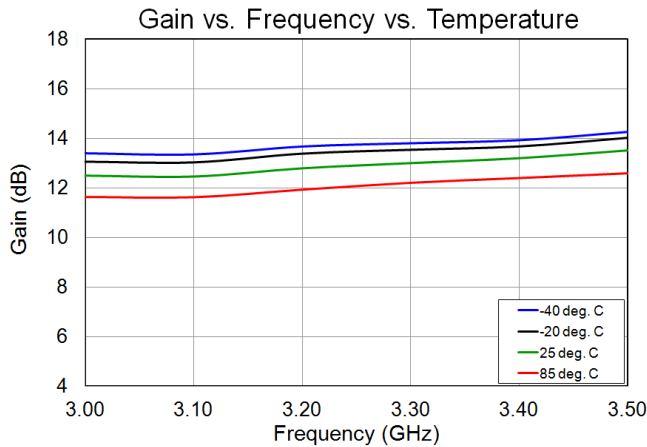

Notes:

1. Test Conditions: $V_{DS} = 28\text{ V}$, $I_{DQ} = 300\text{ mA}$
2. Test Signal: Pulse Width = 100 μs , Duty Cycle = 20%

Evaluation Board Performance (1, 2)

Performance at 3 dB Compression

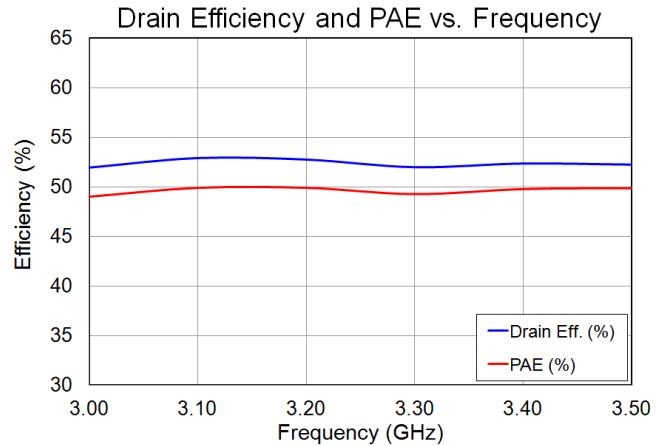
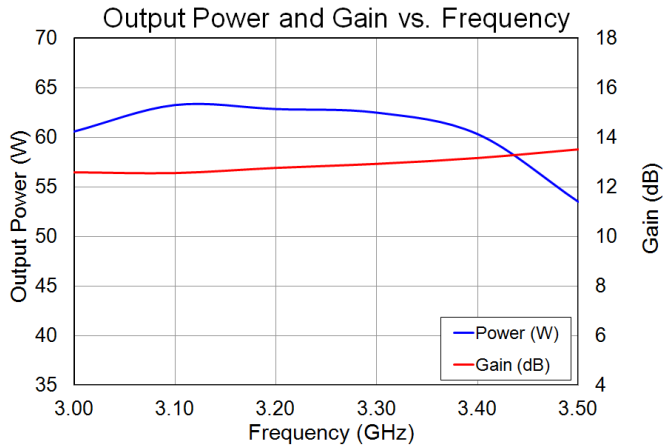

Notes:

1. Test Conditions: $V_{DS} = 28\text{ V}$, $I_{DQ} = 300\text{ mA}$
2. Test Signal: Pulse Width = $100\text{ }\mu\text{s}$, Duty Cycle = 20 %

Application Circuit

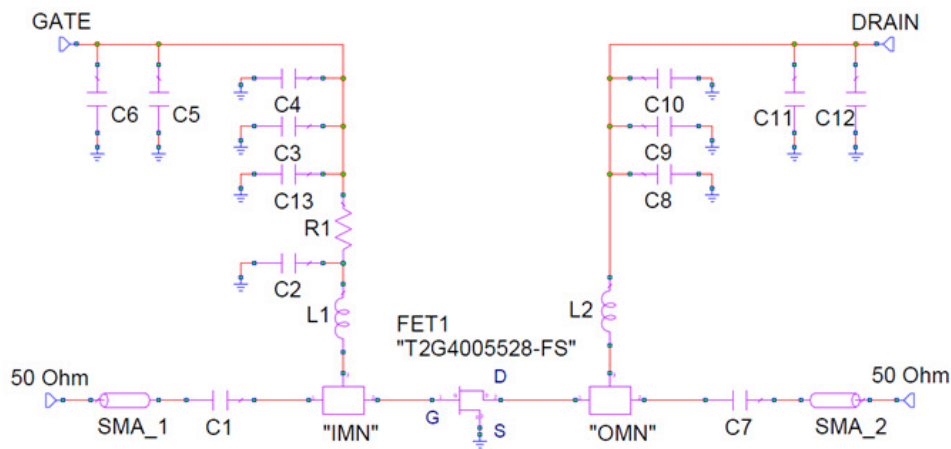

Bias-up Procedure

- Set gate voltage (V_G) to -5.0V
- Set drain voltage (V_D) to 28 V
- Slowly increase V_G until quiescent I_D is 200 mA.
- Apply RF signal

Bias-down Procedure

- Turn off RF signal
- Turn off V_D and wait 1 second to allow drain capacitor dissipation
- Turn off V_G

Evaluation Board Layout

Top RF layer is 0.025" thick Rogers RO3210, $\epsilon_r = 10.2$. The pad pattern shown has been developed and tested for optimized assembly at TriQuint Semiconductor. The PCB land pattern has been developed to accommodate lead and package tolerances.

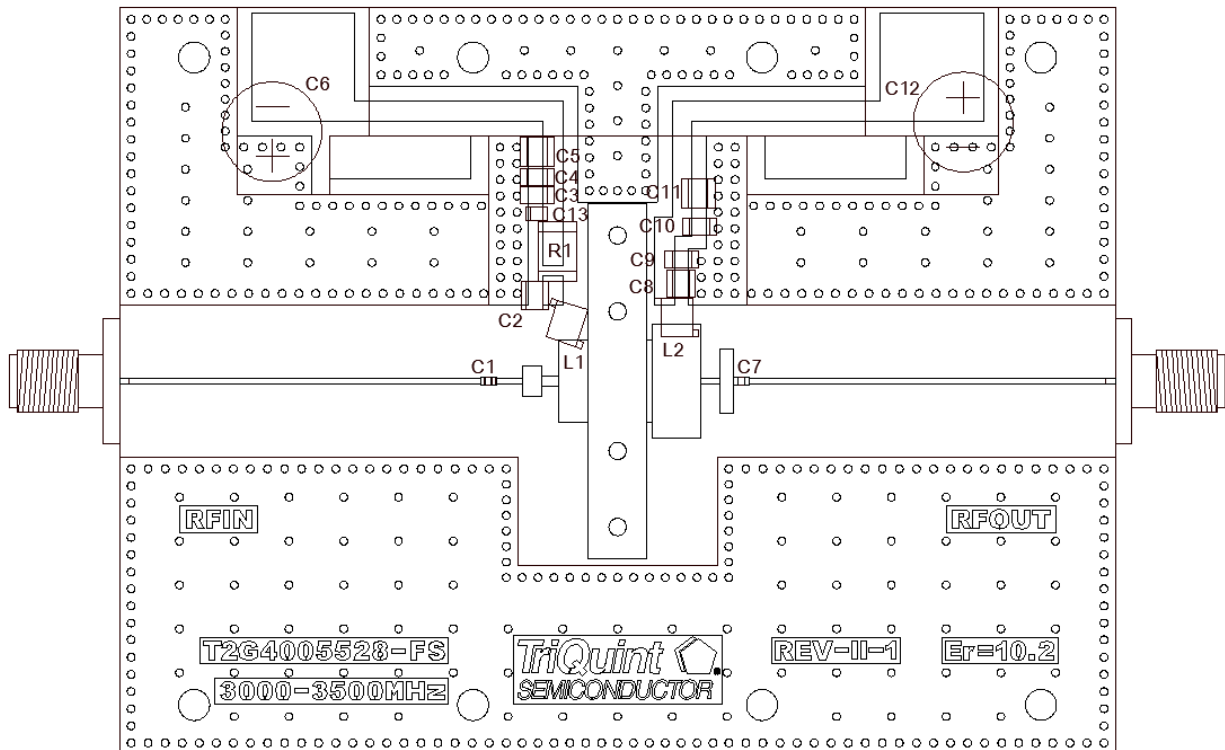

Bill of Materials

Reference Design	Value	Qty	Manufacturer	Part Number
C1, C7	47 pF	2	ATC	100A470JW
C2, C8	82 pF	2	ATC	100B820JW
C3, C9	2200 pF	2	Vitramon	VJ1206Y222KRA
C4, C10	22000 pF	2	Vitramon	48C4641
C5, C11	1 uF	2	Allied	213-0366
C6, C12	470 uF	2	Illinois Cap	477KXM035M
L1, L2	12.5 nH	2	Coilcraft	A04T_JL
R1	2.4 Ohm	1	Vishay Dale	CRCW25122R40JNEG
C13	2400 pF	1	Dielectric Labs	C08BL242X-5UN-X0B

Pin Layout

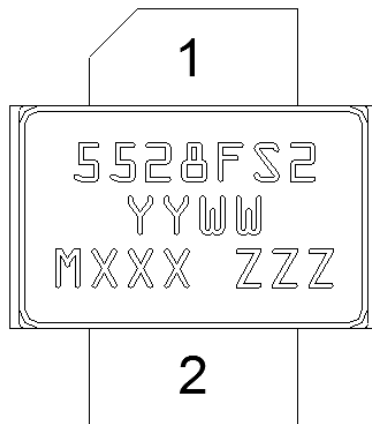

TOP VIEW

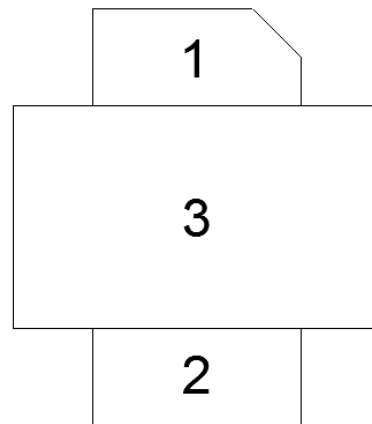

BOTTOM VIEW

Note:

The T2G4005528-FS will be marked with the "5528FS2" designator and a lot code marked below the part designator. The "YY" represents the last two digits of the calendar year the part was manufactured, the "WW" is the work week of the assembly lot start, the "MXXX" is the production lot number, and the "ZZZ" is an auto-generated serial number.

Pin Description

Pin	Symbol	Description
1	V_D / RF OUT	Drain voltage / RF Output matched to 50 ohms; see EVB Layout on page 9 as an example.
2	V_G / RF IN	Gate voltage / RF Input matched to 50 ohms; see EVB Layout on page 9 as an example.
3	Flange	Source connected to ground; see EVB Layout on page 9 as an example.

Notes:

Thermal resistance measured to bottom of package

Mechanical Information

All dimensions are in millimeters.

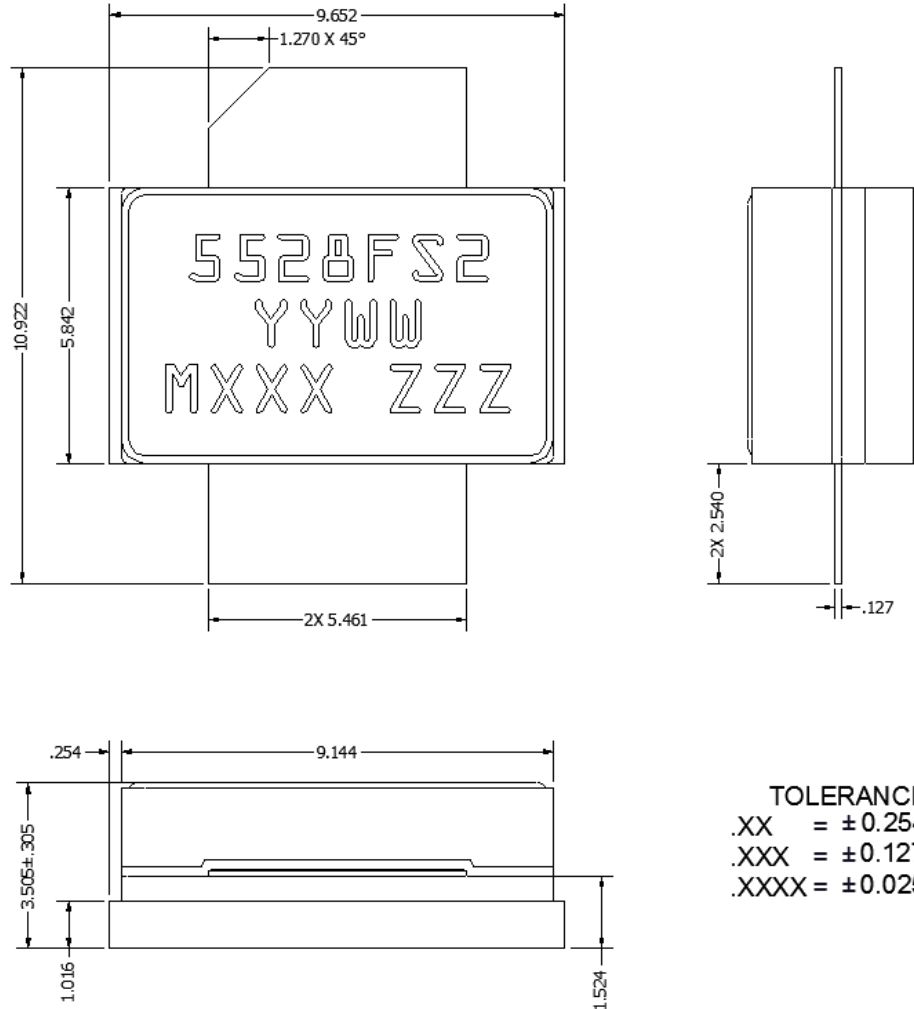

TOLERANCES
 .XX = ±0.254
 .XXX = ±0.127
 .XXXX = ±0.0254

Note:

This package is lead-free/RoHS-compliant. The plating material on the leads is NiAu. It is compatible with both lead-free (maximum 260 °C reflow temperature) and tin-lead (maximum 245°C reflow temperature) soldering processes.

Product Compliance Information

ESD Sensitivity Ratings



Caution! ESD-Sensitive Device

ESD Rating: Class 1A
 Value: Passes ≥ 250 V min.
 Test: Human Body Model (HBM)
 Standard: JEDEC Standard JESD22-A114

MSL Rating

Level 3 at +260 °C convection reflow
 The part is rated Moisture Sensitivity Level 3 at 260 °C per JEDEC standard IPC/JEDEC J-STD-020.

ECCN

US Department of Commerce EAR99

Solderability

Compatible with the latest version of J-STD-020, Lead free solder, 260 °C

RoHS Compliance

This part is compliant with EU 2002/95/EC RoHS directive (Restrictions on the Use of Certain Hazardous Substances in Electrical and Electronic Equipment).

This product also has the following attributes:

- Lead Free
- Halogen Free (Chlorine, Bromine)
- Antimony Free
- TBBP-A (C₁₅H₁₂Br₄O₂) Free
- PFOS Free
- SVHC Free

Recommended Soldering Temperature Profile

