



General Description

The QN3110M6N is the highest performance trench N-Channel MOSFET with extreme high cell density, which provide excellent RDSON and gate charge for most of the synchronous buck converter applications .

The QN3110M6N meet the RoHS and Green Product requirement with full function reliability approved.

Features

- Advanced high cell density Trench technology
- Green Device Available

Product Summary

BVDSS	RDSON (VGS=10V)	ID (Tc=25°C)
30V	1.1mΩ	189A

Applications

- High Frequency Point-of-Load Synchronous Buck Converter for MB/NB/VGA
- Networking DC-DC Power System
- Load Switch

PRPAK 5X6 Pin Configuration

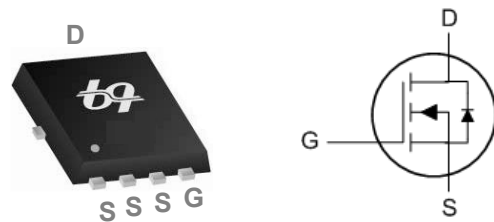

Absolute Maximum Ratings

Symbol	Parameter	Rating	Units
V _{DS}	Drain-Source Voltage	30	V
V _{GS}	Gate-Source Voltage	±20	V
I _D @T _C =25°C	Continuous Drain Current, V _{GS} @ 10V ^{1,7}	189	A
I _D @T _C =100°C	Continuous Drain Current, V _{GS} @ 10V ^{1,7}	120	A
I _D @T _A =25°C	Continuous Drain Current, V _{GS} @ 10V ¹	35	A
I _D @T _A =70°C	Continuous Drain Current, V _{GS} @ 10V ¹	28	A
I _{DM}	Pulsed Drain Current ²	378	A
EAS	Single Pulse Avalanche Energy ³	901.8	mJ
I _{AS}	Avalanche Current	134.3	A
P _D @T _C =25°C	Total Power Dissipation ⁴	59	W
P _D @T _A =25°C	Total Power Dissipation ⁴	2	W
T _{STG}	Storage Temperature Range	-55 to 150	°C
T _J	Operating Junction Temperature Range	-55 to 150	°C

Thermal Data

Symbol	Parameter	Typ.	Max.	Unit
R _{θJA}	Thermal Resistance Junction-Ambient ¹	---	62	°C/W
R _{θJC}	Thermal Resistance Junction-Case ¹	---	2.1	°C/W

Electrical Characteristics ($T_J=25^\circ\text{C}$, unless otherwise noted)

Symbol	Parameter	Conditions	Min.	Typ.	Max.	Unit
BV_{DSS}	Drain-Source Breakdown Voltage	$V_{GS}=0V, I_D=250\mu A$	30	---	---	V
$\Delta BV_{DSS}/\Delta T_J$	BVDSS Temperature Coefficient	Reference to 25°C , $I_D=1\text{mA}$	---	0.009	---	$V/^\circ\text{C}$
$R_{DS(ON)}$	Static Drain-Source On-Resistance ²	$V_{GS}=10V, I_D=30A$	---	0.86	1.1	m Ω
		$V_{GS}=4.5V, I_D=30A$	---	1.1	1.4	
$V_{GS(th)}$	Gate Threshold Voltage	$V_{GS}=V_{DS}, I_D=250\mu A$	1.2	---	2.5	V
$\Delta V_{GS(th)}$	$V_{GS(th)}$ Temperature Coefficient		---	-5.2	---	$\text{mV}/^\circ\text{C}$
I_{DSS}	Drain-Source Leakage Current	$V_{DS}=24V, V_{GS}=0V, T_J=25^\circ\text{C}$	---	---	1	μA
		$V_{DS}=24V, V_{GS}=0V, T_J=55^\circ\text{C}$	---	---	5	
I_{GSS}	Gate-Source Leakage Current	$V_{GS}=\pm 20V, V_{DS}=0V$	---	---	± 100	nA
g_{fs}	Forward Transconductance	$V_{DS}=5V, I_D=15A$	---	46.6	---	S
R_g	Gate Resistance	$V_{DS}=0V, V_{GS}=0V, f=1\text{MHz}$	---	0.9	---	Ω
Q_g	Total Gate Charge (10V)	$V_{DS}=15V, V_{GS}=10V, I_D=15A$	---	95.7	---	nC
Q_g	Total Gate Charge (4.5V)		---	45.2	---	
Q_{gs}	Gate-Source Charge		---	17.6	---	
Q_{gd}	Gate-Drain Charge		---	14.5	---	
$T_{d(on)}$	Turn-On Delay Time	$V_{DD}=15V, V_{GS}=10V, R_G=3.3\Omega, I_D=15A$	---	16.6	---	ns
T_r	Rise Time		---	48.2	---	
$T_{d(off)}$	Turn-Off Delay Time		---	66.0	---	
T_f	Fall Time		---	20.4	---	
C_{iss}	Input Capacitance	$V_{DS}=15V, V_{GS}=0V, f=1\text{MHz}$	---	5924	---	pF
C_{oss}	Output Capacitance		---	2855	---	
C_{rss}	Reverse Transfer Capacitance		---	81	---	

Guaranteed Avalanche Characteristics

Symbol	Parameter	Conditions	Min.	Typ.	Max.	Unit
EAS	Single Pulse Avalanche Energy ⁵	$V_{DD}=50V, L=0.1\text{mH}, I_{AS}=66.2\text{A}$	219.12	---	---	mJ

Diode Characteristics

Symbol	Parameter	Conditions	Min.	Typ.	Max.	Unit
I_S	Continuous Source Current ^{1,6}	$V_G=V_D=0V$, Force Current	---	---	189	A
I_{SM}	Pulsed Source Current ^{2,6}		---	---	378	A
V_{SD}	Diode Forward Voltage ²	$V_{GS}=0V, I_S=1A, T_J=25^\circ\text{C}$	---	---	1.2	V
t_{rr}	Reverse Recovery Time	$I_F=15A, dI/dt=100A/\mu s, T_J=25^\circ\text{C}$	---	84	---	nS
Q_{rr}	Reverse Recovery Charge		---	124	---	nC

Note :

- The data tested by surface mounted on a 1 inch² FR-4 board with 2OZ copper.
- The data tested by pulsed, pulse width $\leq 300\mu s$, duty cycle $\leq 2\%$
- The EAS data shows Max. rating. The test condition is $V_{DD}=50V, V_{GS}=10V, L=0.1\text{mH}$
- The power dissipation is limited by 150°C junction temperature
- The Min. value is 100% EAS tested guarantee.
- The data is theoretically the same as I_D and I_{DM} , in real applications, should be limited by total power dissipation.
- The maximum current rating is package limited.

All information provided in this document is subjected to important notice

Typical Characteristics

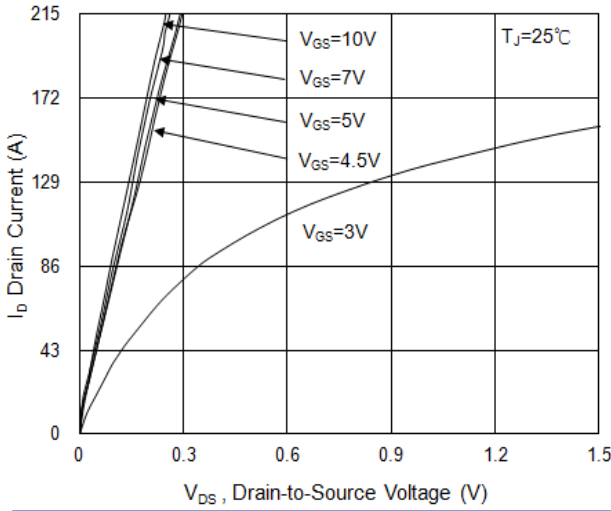

Fig.1 Typical Output Characteristics

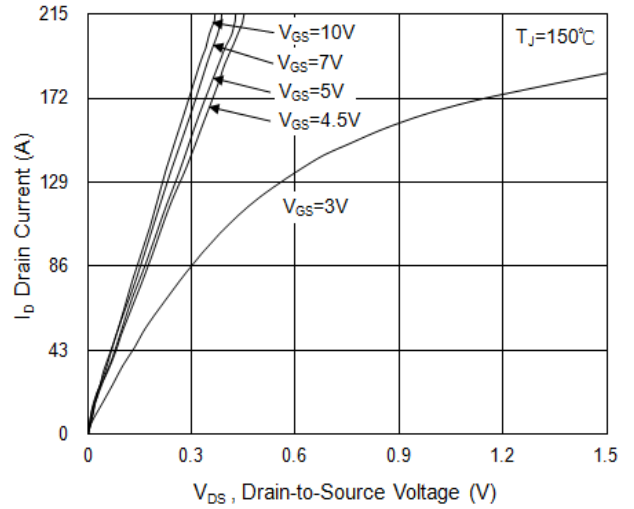

Fig.2 Typical Output Characteristics

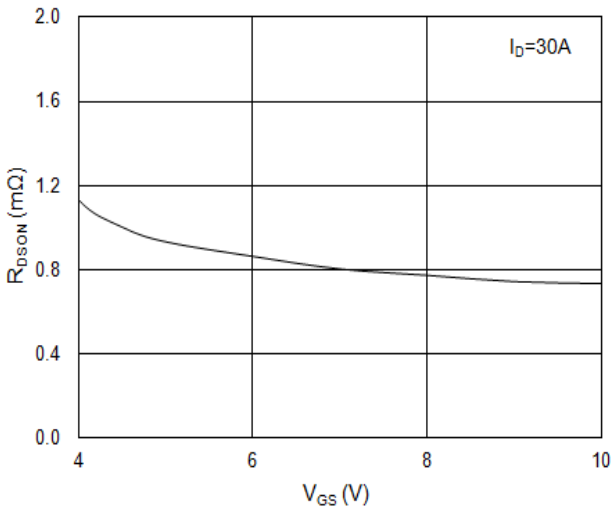

Fig.3 On-Resistance vs. Gate-Source

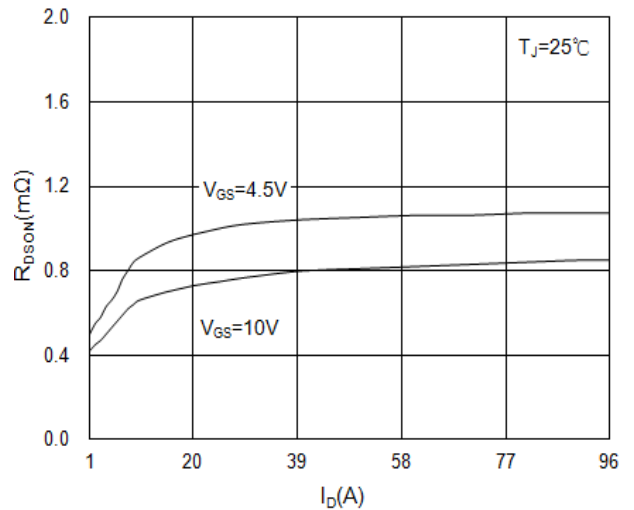

Fig.4 Drain-Source On-State Resistance

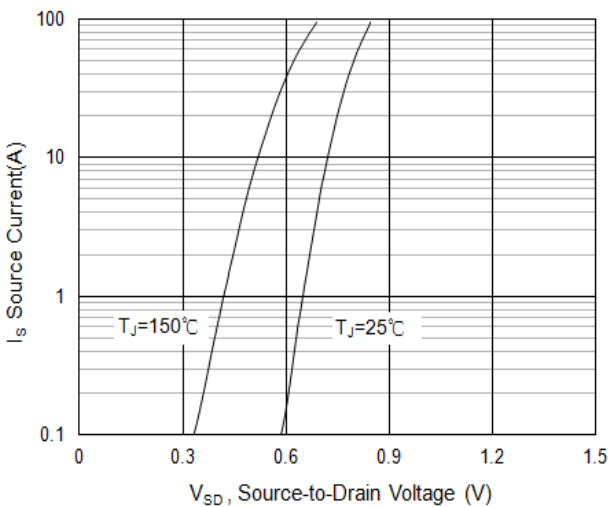

Fig.5 Forward Characteristics of Reverse

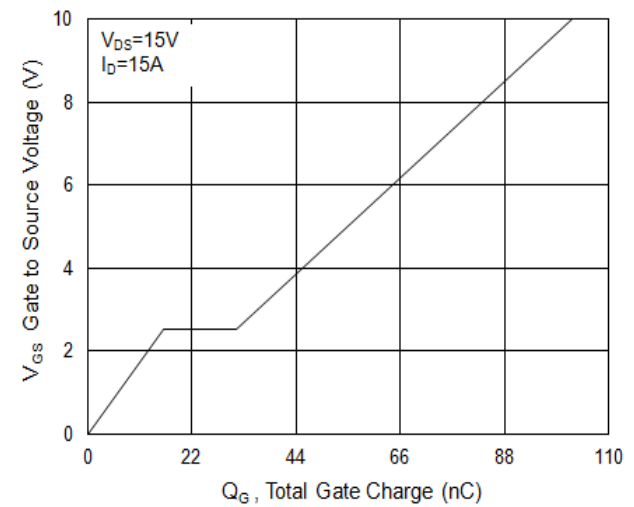

Fig.6 Gate-Charge Characteristics

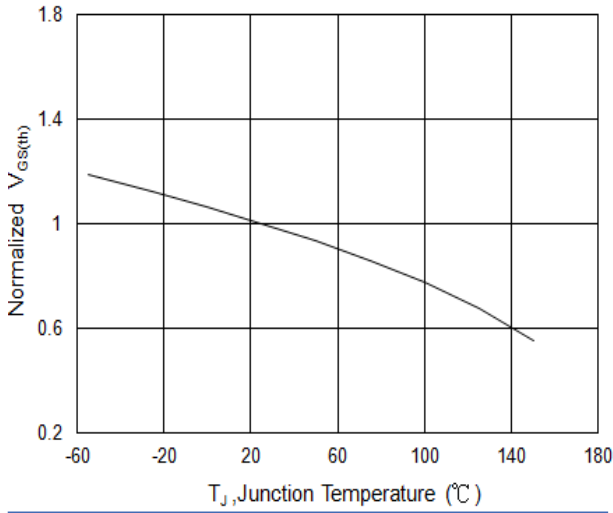

Fig.7 Normalized V_{GS(th)} vs. T_J

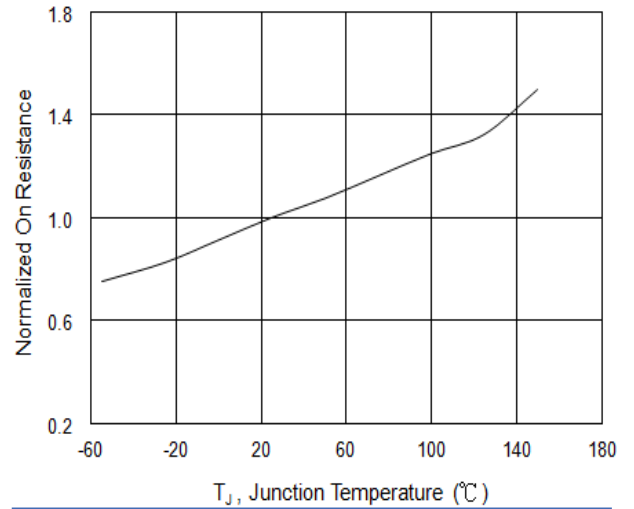

Fig.8 Normalized R_{DS(on)} vs. T_J

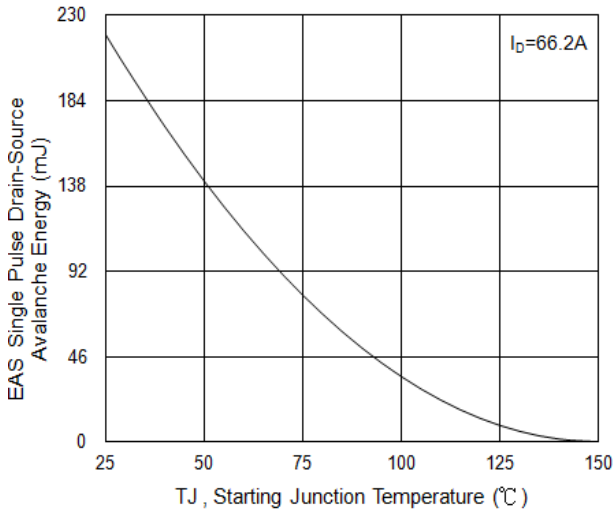

Fig.9 Single Pulse Avalanche Energy

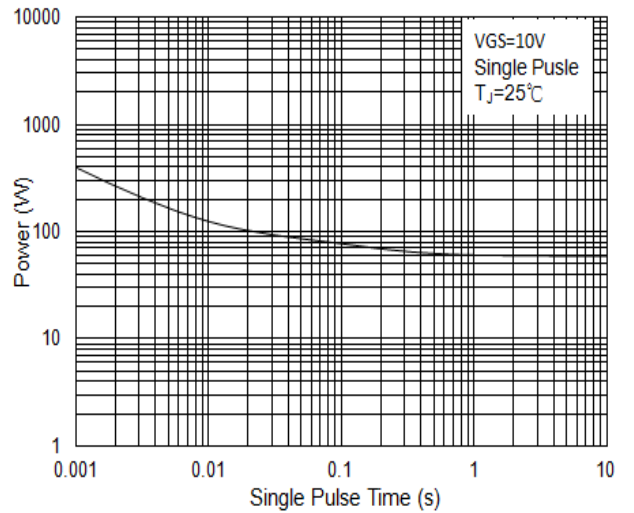

Fig.10 Single Pulse Maximum Power Dissipation

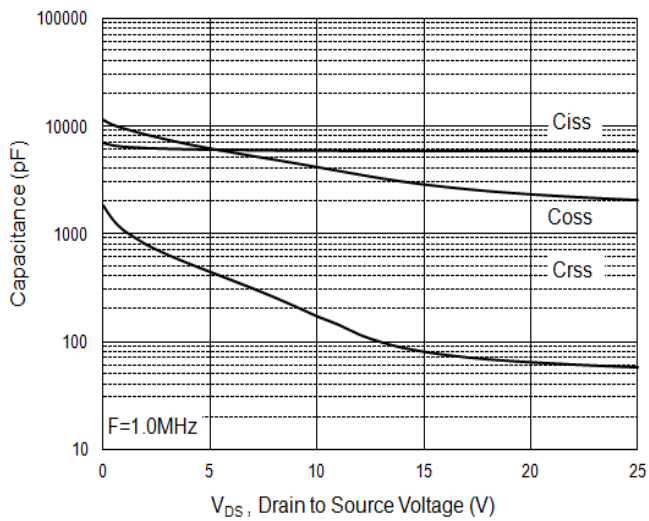

Fig.11 Capacitance

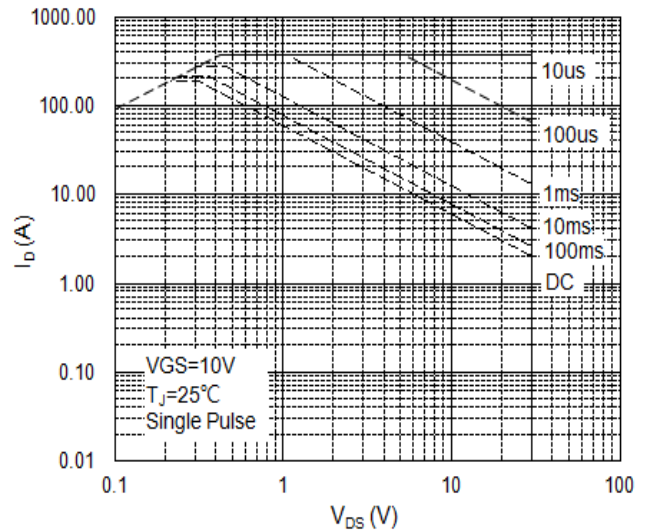

Fig.12 Safe Operating Area

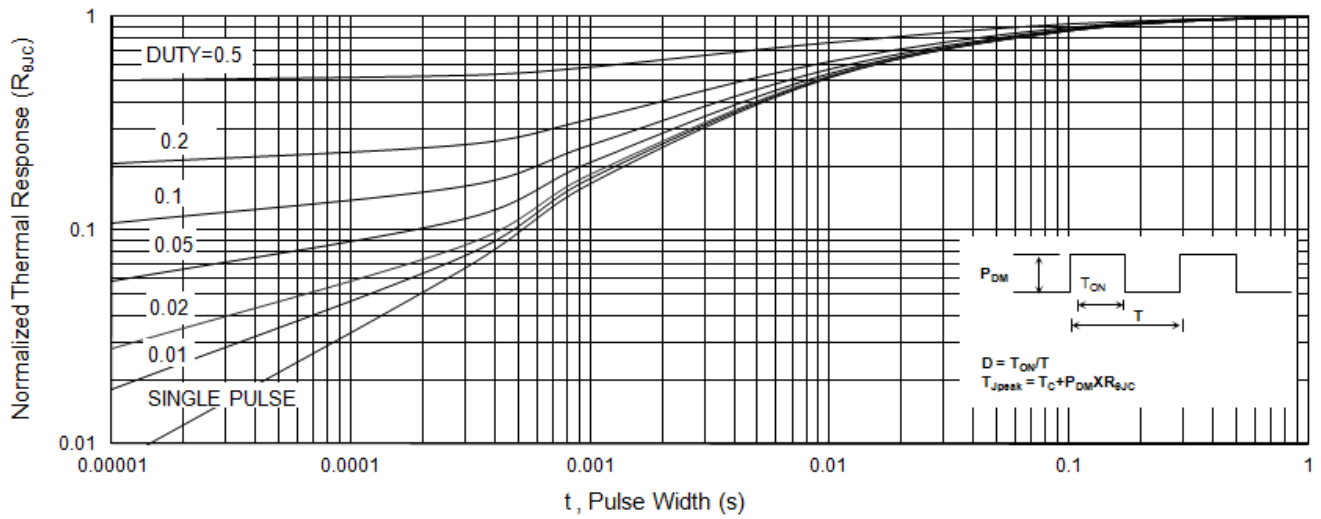
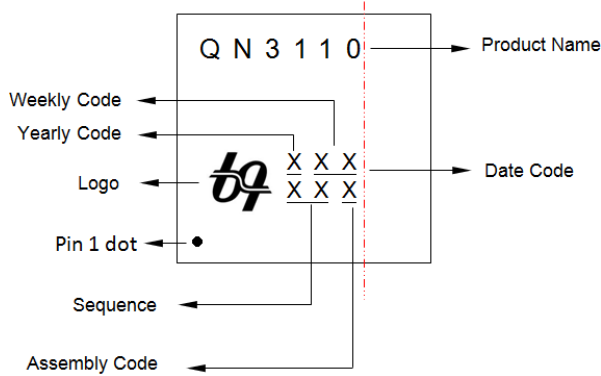
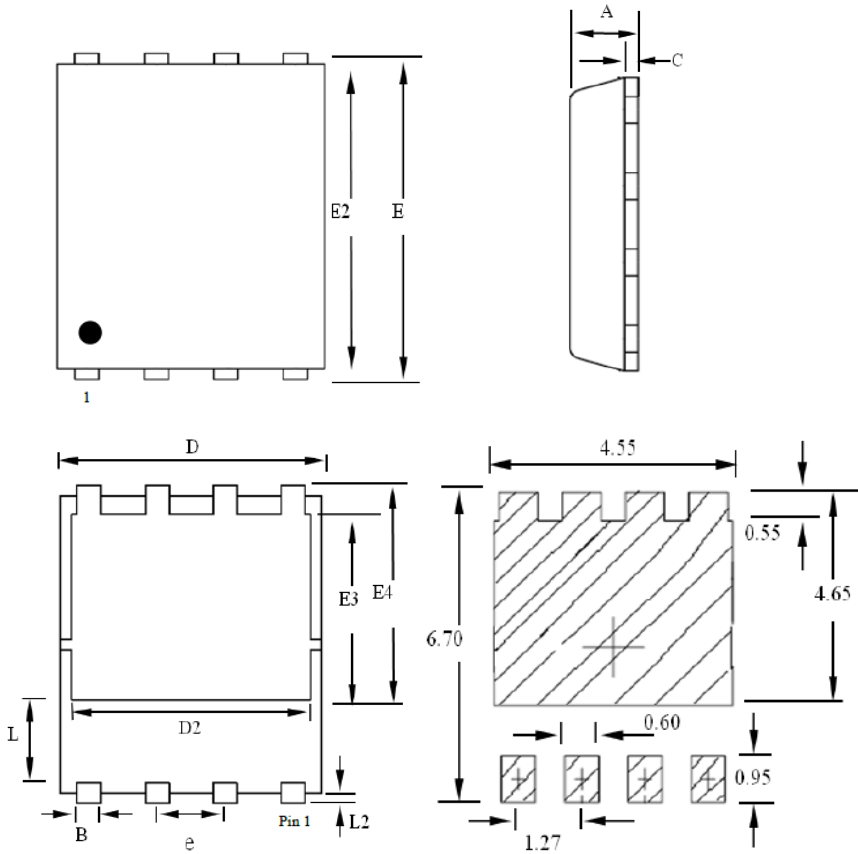

Fig.13 Transient Thermal Impedance

Top Marking



PRPAK5X6 Package Outline Drawing



SYMBOLS	Millimeters		
	MIN	NOM	MAX
A	0.90	1.00	1.20
B	0.33	--	0.51
C	0.20	--	0.34
D	4.50	--	5.10
D2	3.60	--	4.22
E	5.90	--	6.13
E2	5.50	--	5.84
E3	3.18	--	4.30
E4	3.69	--	4.39
L	1.10	--	1.39
L2	0.02	--	0.33
e	--	1.27	--

LAND PATTERN RECOMMENDATION (Unit : mm)

Note:

1. ALL DIMENSIONS LISTED ON THE DRAWING MEETING JEDEC STANDARD.
2. PACKAGE BODY SIZES EXCLUDE MOLD FLASH AND GATE BURRS.
3. RECOMMENDED LAND PATTERN DESIGN IS ONLY FOR REFERENCE

Important Notice

UBIQ and its subsidiaries reserve the right to make corrections, modifications, enhancements, improvements, and other changes to its products and services at any time and to discontinue any product or service without notice. Customers should obtain the latest relevant information before placing orders and should verify that such information is current and complete.

UBIQ products are sold subject to the terms and conditions of sale supplied at the time of order acknowledgment. However, no responsibility is assumed by UBIQ or its subsidiaries for its use or application of any product or circuit; nor for any infringements of patents or other rights of third parties which may result from its use or application, including but not limited to any consequential or incidental damages. No UBIQ components are designed, intended or authorized for use in military, aerospace, automotive applications nor in systems for surgical implantation or life-sustaining. No license is granted by implication or otherwise under any patent or patent rights of UBIQ or its subsidiaries.

UBIQ Semiconductor Corp.

Headquarter

9F.,No.5, Taiyuan 1st St. Zhubei City,

Hsinchu Taiwan, R.O.C.

TEL : 886.3.560.1818 FAX : 886.3.560.1919

Sales Branch Office

12F-5, No. 408, Ruiguang Rd. Neihu District,

Taipei Taiwan, R.O.C.

TEL : 886.2.8751.2062 FAX : 886.2.8751.5064