

### Features

- Low On resistance.
- 4.5V drive.
- RoHS compliant.

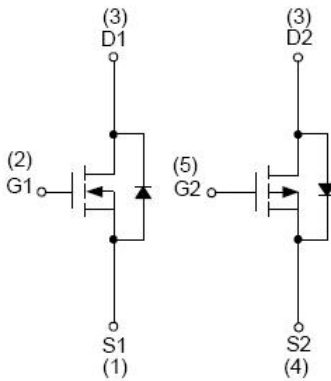
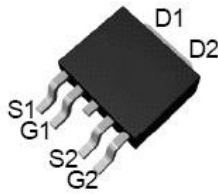

N-Channel MOSFET

P-Channel MOSFET

### Package Dimensions

TO-252-4

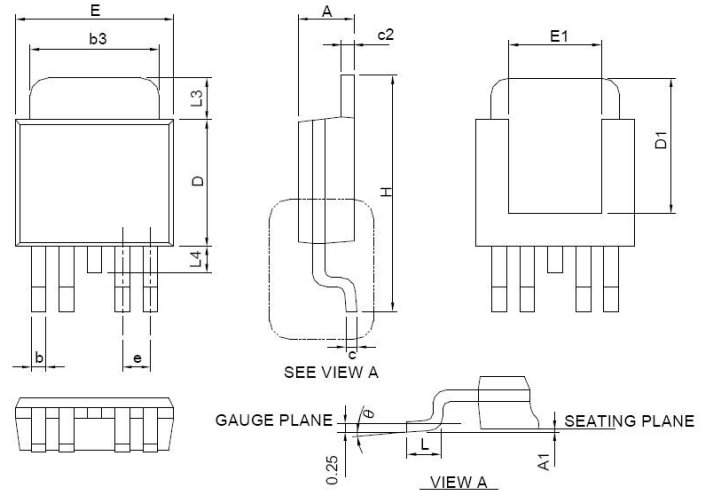

SYMBOL	TO-252-4			
	MILLIMETERS		INCHES	
	MIN.	MAX.	MIN.	MAX.
A	2.18	2.39	0.086	0.094
A1	-	0.2	-	0.008
b	0.50	0.71	0.020	0.028
b3	4.32	5.46	0.170	0.215
c	0.46	0.61	0.018	0.024
c2	0.46	0.89	0.018	0.035
D	5.33	6.22	0.210	0.245
D1	4.57	6.00	0.180	0.236
E	6.35	6.73	0.250	0.265
E1	3.81	6.00	0.150	0.236
e	1.30 BSC		0.051 BSC	
H	9.40	10.41	0.370	0.410
L	1.40	1.78	0.055	0.070
L3	0.89	2.03	0.035	0.080
L4	-	1.02	-	0.040
θ	0°	8°	0°	8°

RECOMMENDED LAND PATTERN

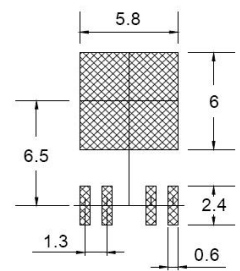

UNIT: mm

### Specifications

Absolute Maximum Ratings at  $T_a=25^{\circ}C$

Parameter	Symbol	Conditions	N-Ch	P-Ch	Unit
Drain-to-Source Voltage	$V_{DSS}$		40	-40	V
Gate-to-Source Voltage	$V_{GSS}$		+20	+20	V
Drain Current (DC)	$I_D$		20	-15	A
Drain Current (Pulse)	$I_{DP}$	$PW \leq 10\mu s$ , duty cycle $\leq 1\%$	35	-28	A
Allowable Power Dissipation	$P_D$	Mounted on a ceramic board (1000mm <sup>2</sup> ×0.8mm) 1unit	30	30	W
Total Dissipation	$P_T$	Mounted on a ceramic board (1000mm <sup>2</sup> ×0.8mm)	5	5	W
Avalanche Energy	$E_{AS}$	$T_J=25^{\circ}C$ , $V_{DS}=20V$ , $V_{GS}=10V$	60	60	mJ
Channel Temperature	$T_{ch}$		150	150	$^{\circ}C$
Storage Temperature	$T_{stg}$		-55~+150	-55~+150	$^{\circ}C$

**Electrical Characteristics (N-Channel) at  $T_a=25^{\circ}\text{C}$** 

Parameter	Symbol	Conditions	Ratings			Unit
			min	typ	max	
Drain-to-Source Breakdown Voltage	$V_{(BR)DSS}$	$I_D=250\mu\text{A}, V_{GS}=0\text{V}$	40	-	-	V
Zero-Gate Voltage Drain Current	$I_{DSS}$	$V_{DS}=40\text{V}, V_{GS}=0\text{V}$	-	-	1	$\mu\text{A}$
Gate-to-Source Leakage Current	$I_{GSS}$	$V_{GS}=\pm 20\text{V}, V_{DS}=0\text{V}$	-	-	$\pm 100$	nA
Gate Threshold Voltage	$V_{GS(th)}$	$V_{DS}=V_{GS}, I_D=250\mu\text{A}$	1	2	3	V
Static Drain-to-Source On-State Resistance	$R_{DS(ON)}$	$I_D=1\text{A}, V_{GS}=10\text{V}$	-	16	24	$\text{m}\Omega$
	$R_{DS(ON)}$	$I_D=1\text{A}, V_{GS}=4.5\text{V}$	-	25	35	$\text{m}\Omega$
Input Capacitance	$C_{iss}$	$V_{DS}=15\text{V}, V_{GS}=0\text{V}, f=1\text{MHz}$	-	980	-	pF
Output Capacitance	$C_{oss}$	$V_{DS}=15\text{V}, V_{GS}=0\text{V}, f=1\text{MHz}$	-	160	-	pF
Reverse Transfer Capacitance	$C_{rss}$	$V_{DS}=15\text{V}, V_{GS}=0\text{V}, f=1\text{MHz}$	-	110	-	pF
Turn-on Delay Time	$t_{d(on)}$	$V_{DS}=15\text{V}, R_L=0.75\Omega, R_{GEN}=1\Omega, V_{GS}=10\text{V}$	-	15	-	nS
Rise Time	$t_r$		-	16	-	nS
Turn-off Delay Time	$t_{d(off)}$		-	36	-	nS
Fall Time	$t_f$		-	13	-	nS
Total Gate Charge	$Q_g$	$V_{DS}=15\text{V}, V_{GS}=10\text{V}, I_D=20\text{A}$	-	26	-	nC
Gate-to-Source Charge	$Q_{gs}$		-	18	-	nC
Gate-to-Drain "Miller" Charge	$Q_{gd}$		-	28	-	nC
Diode Forward Voltage	$V_{SD}$	$I_S=3\text{A}, V_{GS}=0\text{V}$	-	0.75	-	V

**Electrical Characteristics (P-Channel) at  $T_a=25^{\circ}\text{C}$** 

Parameter	Symbol	Conditions	Ratings			Unit
			min	typ	max	
Drain-to-Source Breakdown Voltage	$V_{(BR)DSS}$	$I_D=-250\mu\text{A}, V_{GS}=0\text{V}$	-40	-	-	V
Zero-Gate Voltage Drain Current	$I_{DSS}$	$V_{DS}=-40\text{V}, V_{GS}=0\text{V}$	-	-	-1	$\mu\text{A}$
Gate-to-Source Leakage Current	$I_{GSS}$	$V_{GS}=\pm 20\text{V}, V_{DS}=0\text{V}$	-	-	$\pm 100$	nA
Gate Threshold Voltage	$V_{GS(th)}$	$V_{DS}=V_{GS}, I_D=-250\mu\text{A}$	-1	-2	-3	V
Static Drain-to-Source On-State Resistance	$R_{DS(ON)}$	$I_D=-1\text{A}, V_{GS}=-10\text{V}$	-	30	42	$\text{m}\Omega$
	$R_{DS(ON)}$	$I_D=-1\text{A}, V_{GS}=-4.5\text{V}$	-	49	70	$\text{m}\Omega$
Input Capacitance	$C_{iss}$	$V_{DS}=-15\text{V}, V_{GS}=0\text{V}, f=1\text{MHz}$	-	1020	-	pF
Output Capacitance	$C_{oss}$	$V_{DS}=-15\text{V}, V_{GS}=0\text{V}, f=1\text{MHz}$	-	180	-	pF
Reverse Transfer Capacitance	$C_{rss}$	$V_{DS}=-15\text{V}, V_{GS}=0\text{V}, f=1\text{MHz}$	-	120	-	pF
Turn-on Delay Time	$t_{d(on)}$	$V_{DS}=-15\text{V}, R_L=0.75\Omega, R_{GEN}=1\Omega, V_{GS}=10\text{V}$	-	16	-	nS
Rise Time	$t_r$		-	18	-	nS
Turn-off Delay Time	$t_{d(off)}$		-	49	-	nS
Fall Time	$t_f$		-	15	-	nS
Total Gate Charge	$Q_g$	$V_{DS}=-15\text{V}, V_{GS}=10\text{V}, I_D=-10\text{A}$	-	28	-	nC
Gate-to-Source Charge	$Q_{gs}$		-	21	-	nC
Gate-to-Drain "Miller" Charge	$Q_{gd}$		-	32	-	nC
Diode Forward Voltage	$V_{SD}$	$I_S=-3\text{A}, V_{GS}=0\text{V}$	-	-0.75	-	V

Typical Characteristics (N-Channel) at  $T_a=25^\circ\text{C}$

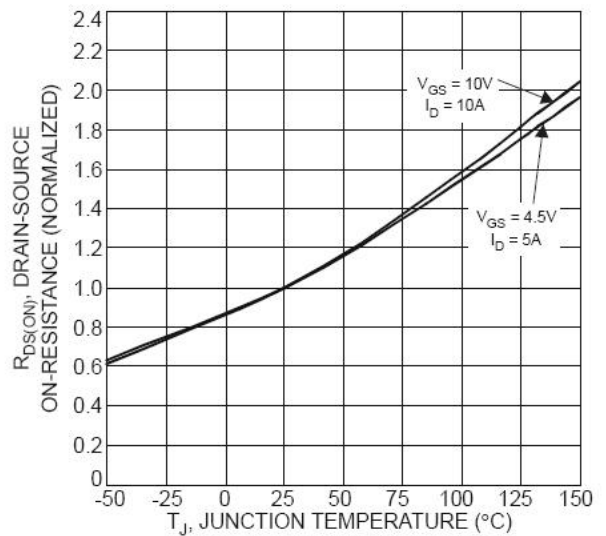
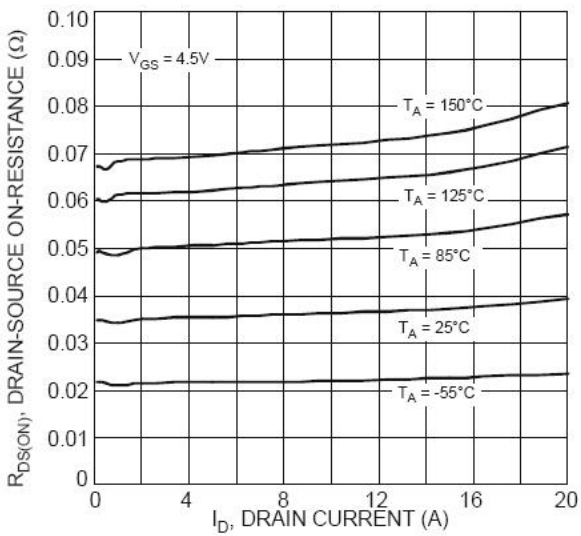
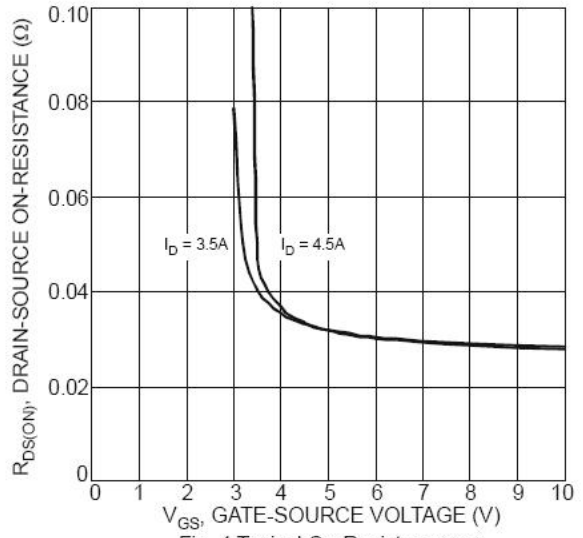
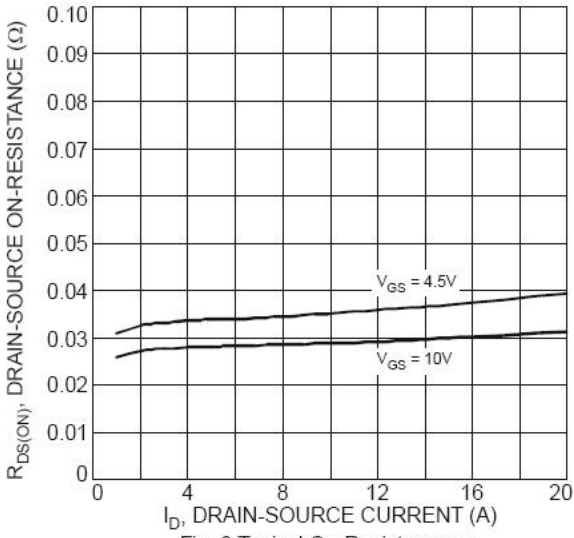
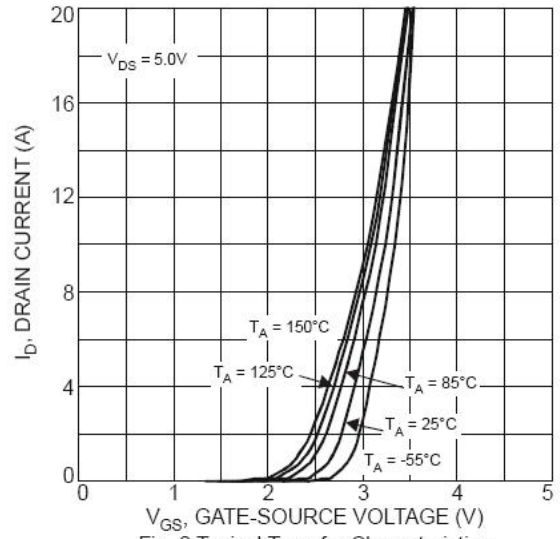
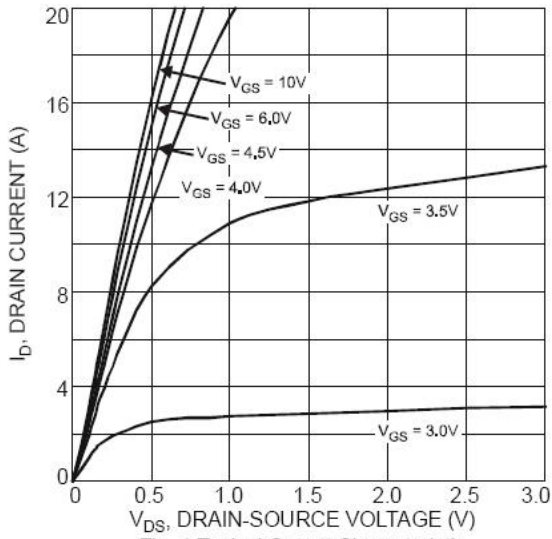

Typical Characteristics (N-Channel) at  $T_a=25^\circ\text{C}$  (Continued)

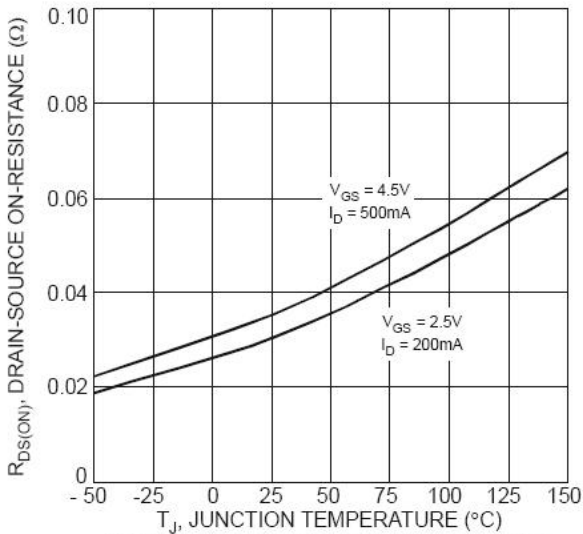

Fig. 7 On-Resistance Variation with Temperature

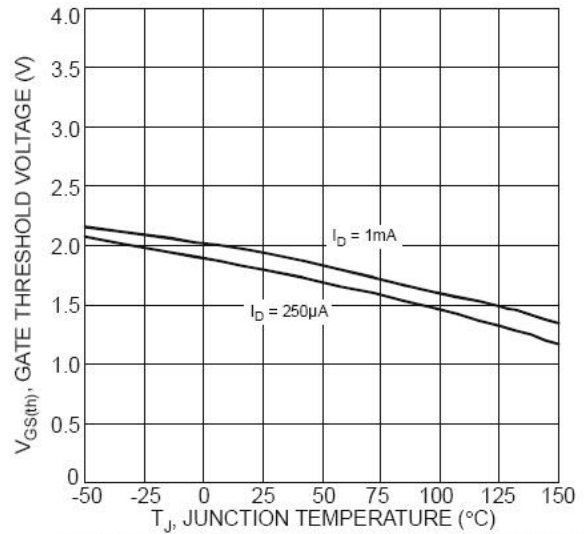

Fig. 8 Gate Threshold Variation vs. Ambient Temperature

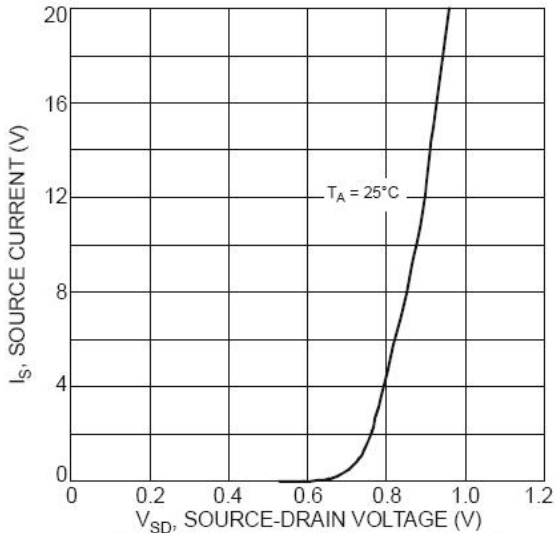

Fig. 9 Diode Forward Voltage vs. Current

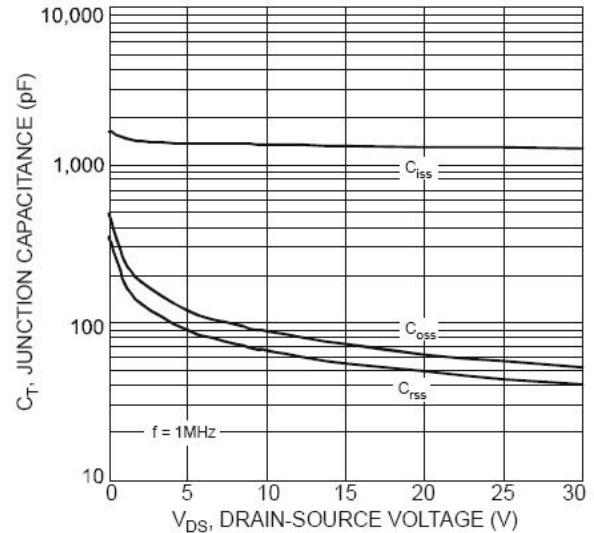

Fig. 10 Typical Junction Capacitance

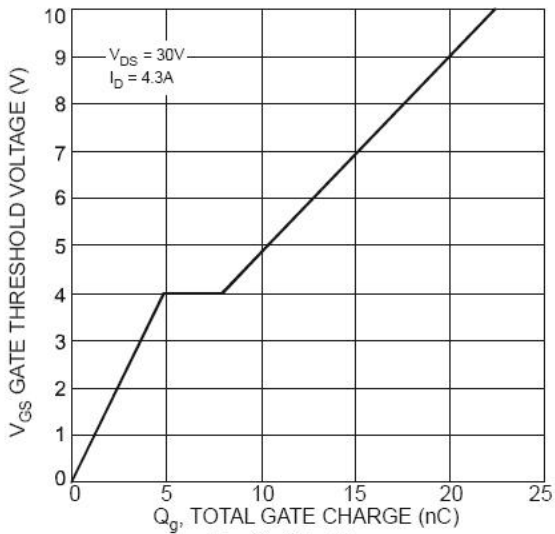

Fig. 11 Gate Charge

Typical Characteristics (P-Channel) at  $T_a=25^{\circ}\text{C}$

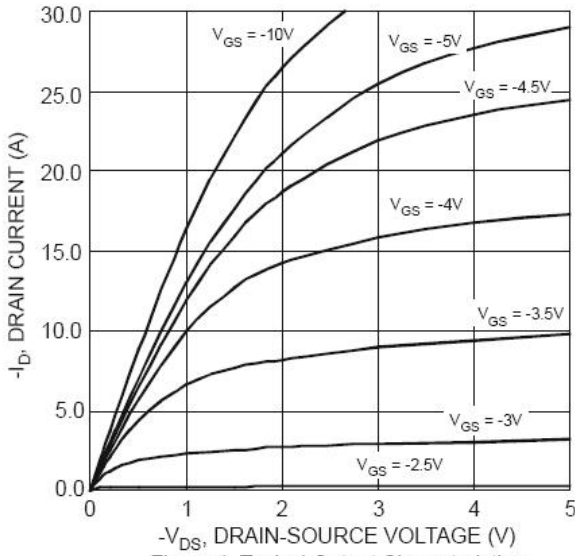

Figure 1 Typical Output Characteristics

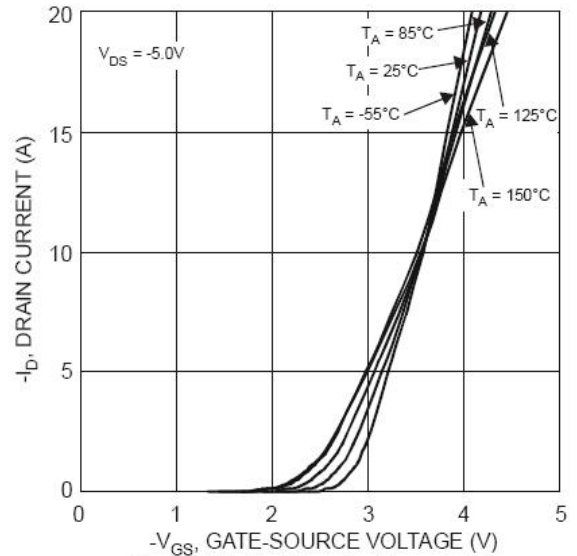

Figure 2 Typical Transfer Characteristics

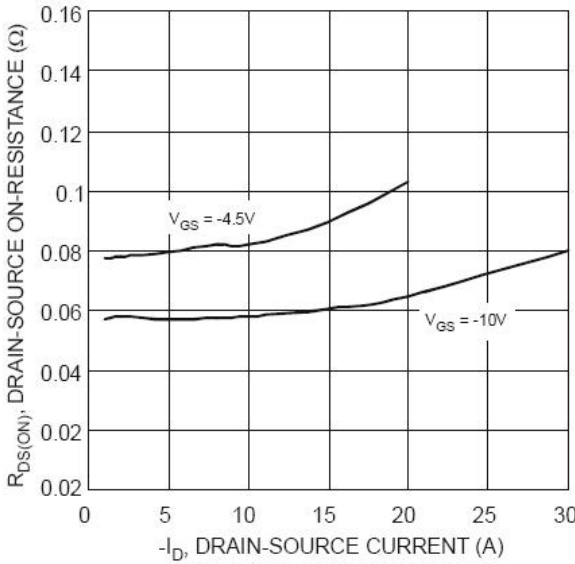

Figure 3 Typical On-Resistance vs. Drain Current and Gate Voltage

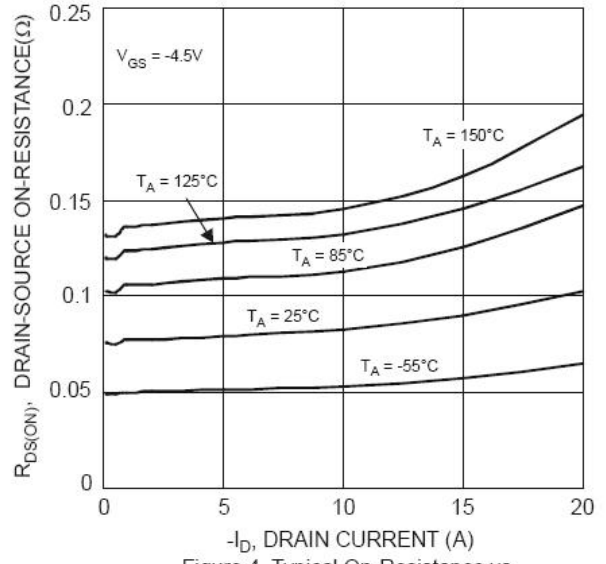

Figure 4 Typical On-Resistance vs. Drain Current and Temperature

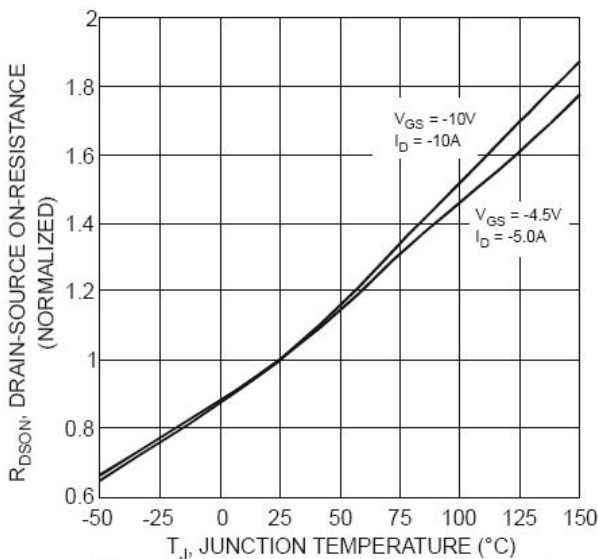

Figure 5 On-Resistance Variation with Temperature

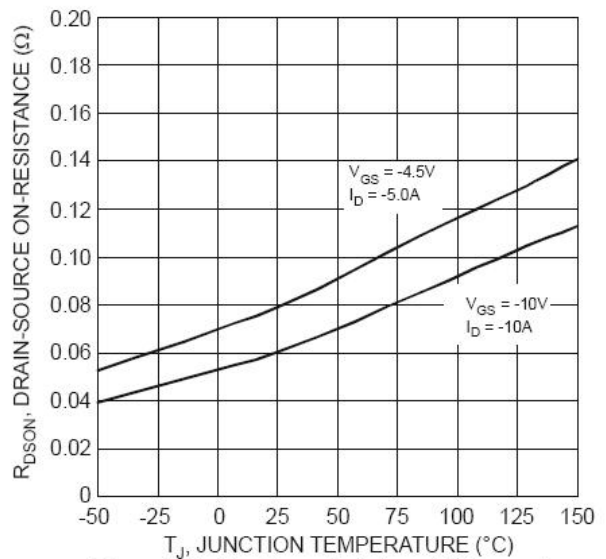

Figure 6 On-Resistance Variation with Temperature

Typical Characteristics (P-Channel) at  $T_a=25^\circ\text{C}$  (Continued)

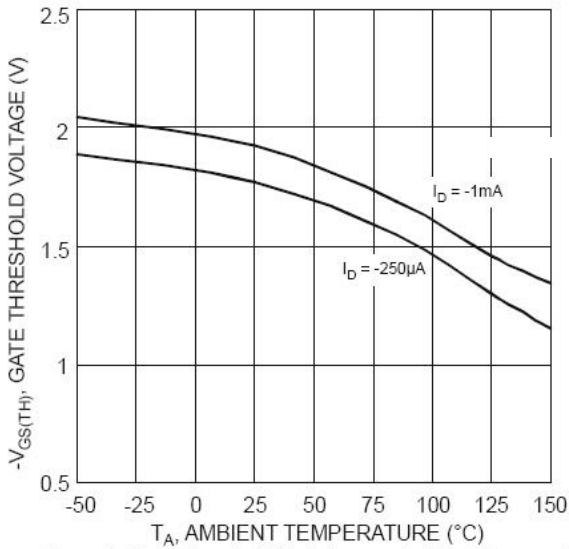

Figure 7 Gate Threshold Variation vs. Ambient Temperature

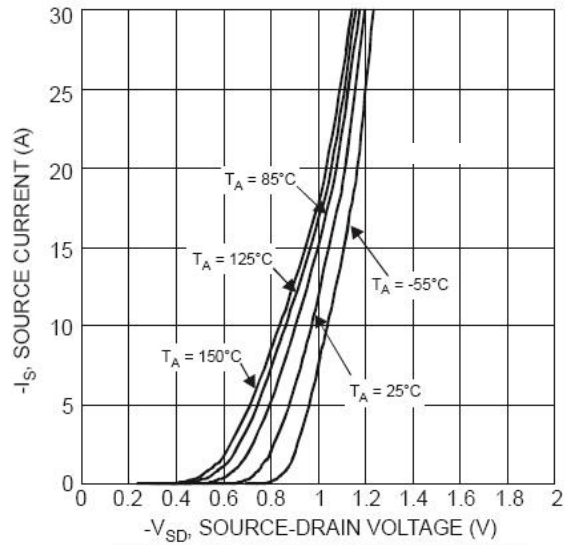

Figure 8 Diode Forward Voltage vs. Current

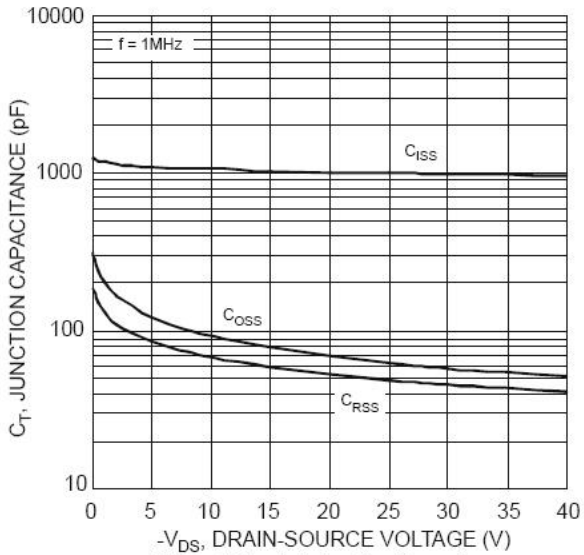

Figure 9 Typical Junction Capacitance

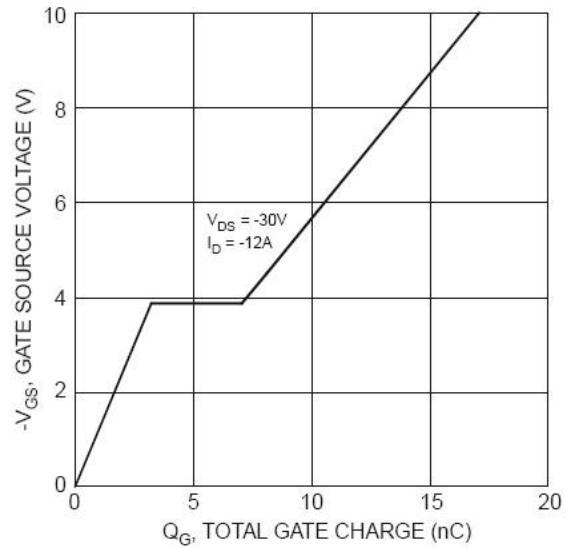

Figure 10 Gate Charge Characteristics