



# Agilent ABA-54563 3.4 GHz Broadband Silicon RFIC Amplifier Data Sheet

## Description

Agilent's ABA-54563 is an economical, easy-to-use internally 50-ohm matched silicon monolithic amplifier that offers excellent gain and broadband response from DC to 3.4 GHz. Packaged in an ultraminiature industry-standard SOT-363 package, it requires half the board space of a SOT-143 package.

At 2 GHz, the ABA-54563 offers a small-signal gain of 23 dB, output P<sub>1dB</sub> of 16.1 dBm and 27.8 dBm output third order intercept point. It is suitable for use as buffer amplifiers for wideband applications. They are designed for low cost gain blocks in cellular applications, DBS tuners, LNB and other wireless communications systems.

At IF frequencies, the ABA-54563 offers good linearity performance with a typical OIP<sub>3</sub> of 35 dBm at 200 MHz.

ABA-54563 is fabricated using Agilent's HP25 silicon bipolar process, which employs a double-diffused single polysilicon process with self-aligned submicron emitter geometry. The process is capable of simultaneous high  $f_T$  and high NPN breakdown (25 GHz  $f_T$  at 6V BVCEO). The process utilizes industry standard device oxide isolation technologies and submicron aluminum multilayer interconnect to achieve superior performance, high uniformity and proven reliability.

## Surface Mount Package SOT-363 / SC70

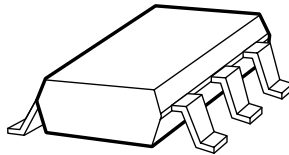

## Pin Connections and Package Marking

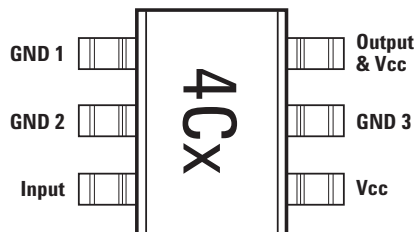

### Note:

Top View. Package marking provides orientation and identification. "x" is character to identify date code.

## Simplified Schematic

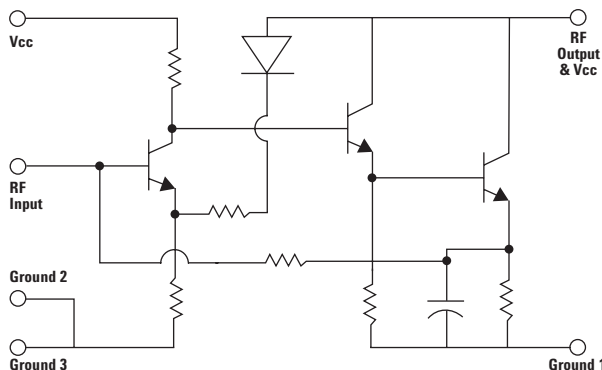

## Features

- Single +5V Supply
- High linearity
- VSWR < 1.4 throughout operating frequency
- Miniature SOT363 (SC70) Package
- Unconditionally stable
- Lead-free

## Typical Performance at +5V/79 mA

- 2 GHz**
- 23 dB Gain
  - 27.8 dBm OIP<sub>3</sub>
  - 16.1 dBm P<sub>1dB</sub>
  - 4.4 dB Noise Figure

- 200 MHz**
- 23 dB Gain
  - 35 dBm OIP<sub>3</sub>
  - 18 dBm P<sub>1dB</sub>
  - 3.6 dB Noise Figure



### ABA-54563 Absolute Maximum Ratings<sup>[1]</sup>

Symbol	Parameter	Units	Absolute Max.
$V_{cc}$	Device Voltage, RF output to ground (T = 25°C)	V	6
$P_{in}$	CW RF Input Power	dBm	20
$P_{diss}$	Total Power Dissipation <sup>[3]</sup>	mW	560
$\theta_{j-c}$	Thermal Resistance <sup>[2]</sup>	°C/W	110
$T_j$	Junction Temperature	°C	150
$T_{STG}$	Storage Temperature	°C	-65 to 150

**Notes:**

1. Operation of this device in excess of any of these limits may cause permanent damage.
2. Thermal resistance measured using 150°C Liquid Crystal Measurement method.
3. Case temperature  $T_c$  at 25°C. Derate at 9.1mW/°C for  $T_c > 87.5^\circ\text{C}$ .

### Product Consistency Distribution Charts at 5.0V and 2 GHz.<sup>[1]</sup>

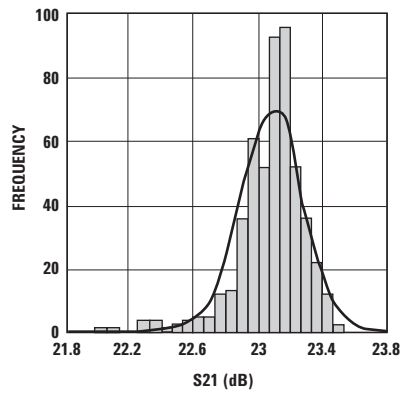

Figure 1. S21 Distribution.

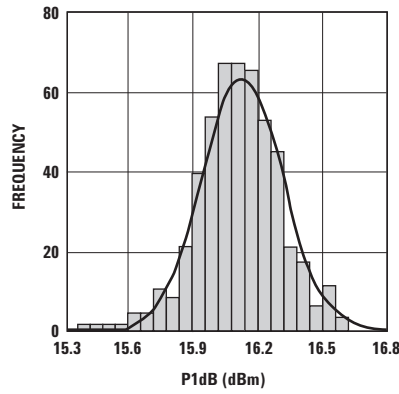

Figure 2. P1dB Distribution.

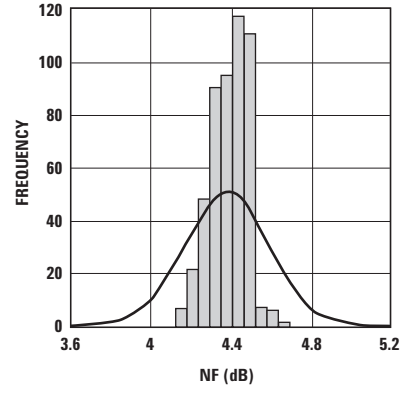

Figure 3. Noise Figure Distribution.

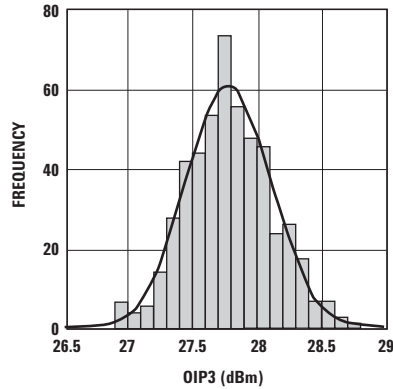

Figure 4. OIP3 Distribution.

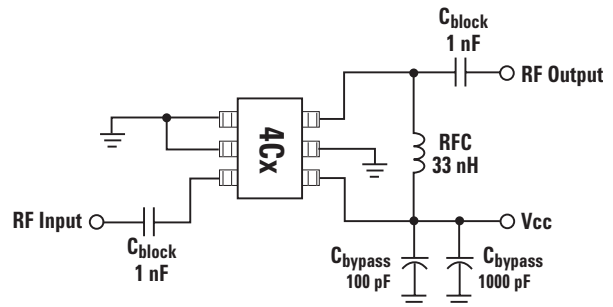

Figure 5. Test circuit at of the 2 GHz production test board used for NF, Gain and OIP3 measurements. Circuit losses have been de-embedded from actual measurements.

**Note:**

1. Measured on the production test circuit base on 500 samples.

## Electrical Specifications

$T_c = +25^\circ\text{C}$ ,  $Z_o = 50\ \Omega$ ,  $P_{in} = -30\ \text{dBm}$ ,  $V_{cc} = 5\text{V}$ ,  $\text{Freq} = 2\ \text{GHz}$ , unless stated otherwise.

Symbol	Parameter and Test Condition	Units	Min.	Typ.	Max.	Std Dev.
$G_p$	Power Gain ( $ S_{21} ^2$ ) f = 200 MHz f = 2.0 GHz	dB	21	23 23	25	0.2
$\Delta G_p$	Power Gain Flatness, f = 0.1 ~ 2.0 GHz f = 0.1 ~ 3.4 GHz	dB		0.5 3.0		
NF	Noise Figure f = 200 MHz f = 2.0 GHz	dB		3.6 4.4	4.8	0.08
$P_{1\text{dB}_{50\Omega}}$	Output Power at 1dB Gain Compression f = 200 MHz f = 2.0 GHz	dBm		18.0 16.1		0.18
OIP3	Output Third Order Intercept Point f = 200 MHz f = 2.0 GHz	dBm		35.0 27.8		0.32
$VSWR_{in}$	Input VSWR f = 200 MHz f = 2.0 GHz			1.20 1.11		0.02
$VSWR_{out}$	Output VSWR f = 200 MHz f = 2.0 GHz			1.20 1.14		0.02
$I_{cc}$	Device Current	mA		79	90	0.2

### Notes:

Measurements taken on 50 $\Omega$  test board shown on Figure 1. Excess circuit losses had been de-embedded from actual measurements. Standard deviation and typical data based on at least 500 parts sample size from 2 wafer lots. Future wafers allocated to this product may have nominal values anywhere within the upper and lower spec limits.

### ABA-54563 Typical Performance

$T_c = +25^\circ\text{C}$ ,  $Z_o = 50\Omega$ ,  $V_{cc} = 5\text{V}$  unless stated otherwise.

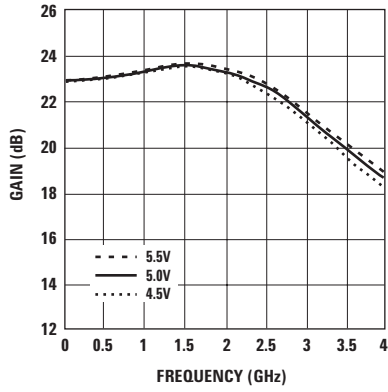

Figure 6. Gain vs. Frequency and Voltage.

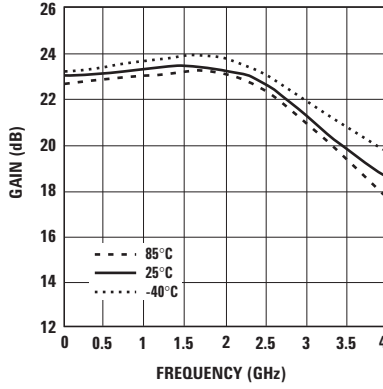

Figure 7. Gain vs. Frequency and Temperature.

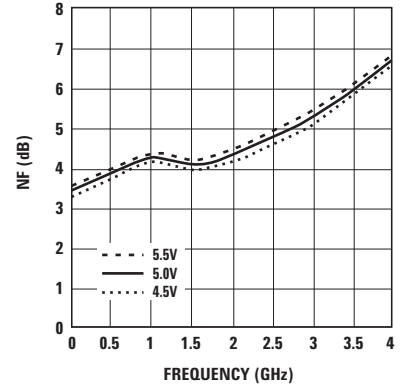

Figure 8. Noise Figure vs. Frequency and Voltage.

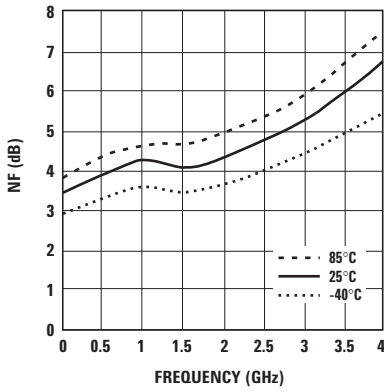

Figure 9. Noise Figure vs. Frequency and Temperature.

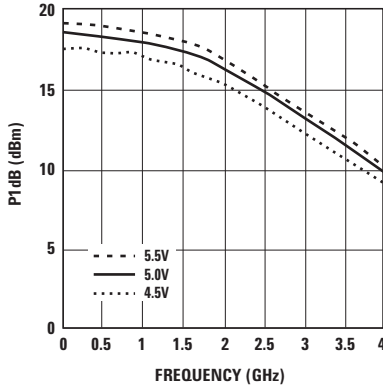

Figure 10. Output Power for 1dB Gain Compression vs. Frequency and Voltage.

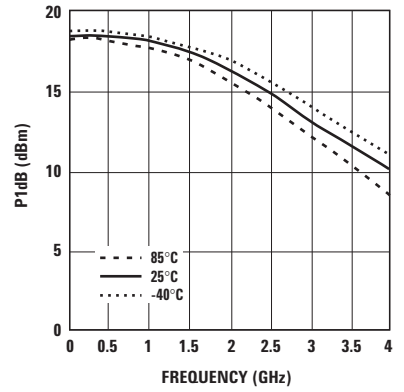
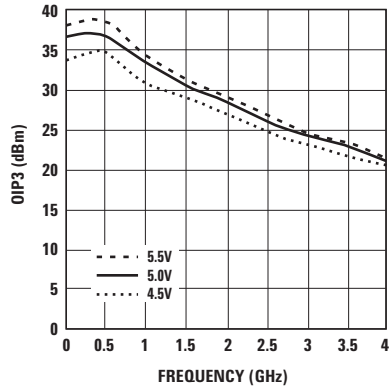

Figure 11. Output Power for 1dB Gain Compression vs. Frequency and Temperature.

**ABA-54563 Typical Performance, continued**

$T_c = +25^\circ\text{C}$ ,  $Z_o = 50\Omega$ ,  $V_{cc} = 5\text{V}$  unless stated otherwise.



**Figure 12. Output IP3 vs. Frequency and Voltage.**

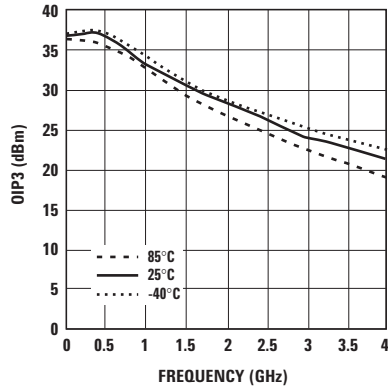

**Figure 13. Output IP3 vs. Frequency and Temperature.**

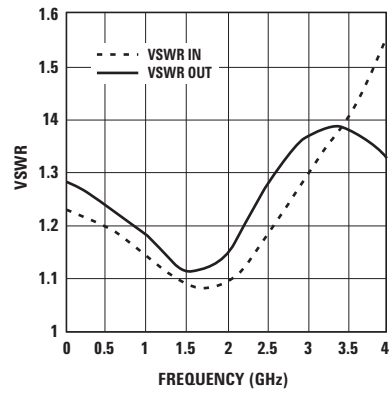

**Figure 14. Input and Output VSWR vs. Frequency.**

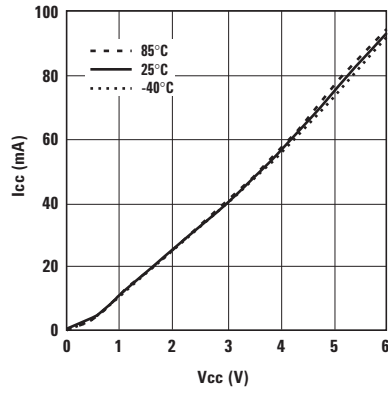

**Figure 15. Supply Current vs. Voltage and Temperature.**

### ABA-54563 Typical Scattering Parameters

$T_C = +25^\circ\text{C}$ ,  $Z_0 = 50 \Omega$ ,  $V_{cc} = 4.5\text{V}$ , unless stated otherwise

Freq (GHz)	S <sub>11</sub> Mag.	S <sub>11</sub> Ang.	S <sub>21</sub> dB	S <sub>21</sub> Mag.	S <sub>21</sub> Ang.	S <sub>12</sub> dB	S <sub>12</sub> Mag.	S <sub>12</sub> Ang.	S <sub>22</sub> Mag.	S <sub>22</sub> Ang.	K Factor
0.1	0.098	175.8	23.0	14.06	-5.1	-31.4	0.027	-0.2	0.142	-6.5	1.5
0.2	0.094	174.2	23.0	14.09	-9.9	-31.4	0.027	0.0	0.141	-13.0	1.5
0.3	0.090	173.3	23.0	14.14	-14.9	-31.7	0.026	0.7	0.141	-18.8	1.5
0.4	0.084	172.3	23.0	14.17	-19.9	-31.7	0.026	1.6	0.141	-24.5	1.5
0.5	0.087	157.6	23.0	14.19	-25.1	-31.7	0.026	2.5	0.129	-25.0	1.5
0.6	0.084	152.7	23.1	14.22	-30.2	-31.7	0.026	3.7	0.126	-27.9	1.5
0.7	0.081	146.2	23.1	14.26	-35.3	-31.7	0.026	4.9	0.122	-30.6	1.5
0.8	0.076	140.3	23.1	14.31	-40.4	-31.7	0.026	6.3	0.117	-33.4	1.5
0.9	0.071	136.0	23.2	14.39	-45.7	-31.7	0.026	7.7	0.112	-36.3	1.5
1.0	0.067	130.2	23.2	14.45	-51.0	-31.7	0.026	9.0	0.106	-38.4	1.5
1.2	0.053	122.0	23.3	14.58	-61.9	-31.7	0.026	11.8	0.095	-42.1	1.5
1.4	0.040	118.7	23.3	14.69	-73.2	-31.7	0.026	14.5	0.081	-43.7	1.5
1.6	0.027	124.9	23.4	14.75	-85.0	-31.4	0.027	17.4	0.068	-40.5	1.4
1.8	0.018	155.0	23.3	14.66	-97.2	-31.1	0.028	19.8	0.058	-29.1	1.4
2.0	0.023	-174.5	23.2	14.39	-109.9	-30.5	0.030	22.3	0.058	-8.3	1.4
2.2	0.043	-164.5	22.9	14.04	-122.4	-30.2	0.031	24.1	0.069	-2.4	1.4
2.4	0.058	-165.3	22.5	13.41	-134.9	-29.6	0.033	25.9	0.087	3.6	1.3
2.6	0.076	-171.1	22.1	12.72	-146.9	-29.4	0.034	26.7	0.106	0.3	1.3
2.8	0.093	-177.5	21.5	11.95	-158.4	-28.9	0.036	27.2	0.122	-6.1	1.3
3.0	0.113	173.8	21.0	11.17	-169.5	-28.4	0.038	28.0	0.126	-13.4	1.3
3.2	0.125	167.4	20.3	10.39	-179.7	-27.7	0.041	27.5	0.135	-21.1	1.3
3.4	0.144	160.7	19.7	9.71	170.6	-27.3	0.043	26.9	0.136	-31.7	1.4
3.5	0.154	157.1	19.5	9.40	165.8	-27.3	0.043	27.0	0.131	-36.9	1.4
4.0	0.202	137.5	18.2	8.10	143.0	-26.2	0.049	26.0	0.109	-62.8	1.4
4.5	0.237	115.5	16.9	7.00	119.4	-24.9	0.057	25.0	0.074	-92.4	1.4
5.0	0.245	97.9	15.3	5.81	96.6	-23.6	0.066	21.4	0.050	-132.0	1.4
5.5	0.247	86.8	13.7	4.82	77.5	-22.4	0.076	15.9	0.056	-163.0	1.5
6.0	0.246	78.1	12.2	4.09	59.4	-21.4	0.085	9.3	0.088	168.9	1.5

### ABA-54563 Typical Scattering Parameters

$T_C = +25^\circ\text{C}$ ,  $Z_0 = 50 \Omega$ ,  $V_{CC} = 5.0\text{V}$ , unless stated otherwise

Freq (GHz)	S <sub>11</sub> Mag.	S <sub>11</sub> Ang.	S <sub>21</sub> dB	S <sub>21</sub> Mag.	S <sub>21</sub> Ang.	S <sub>12</sub> dB	S <sub>12</sub> Mag.	S <sub>12</sub> Ang.	S <sub>22</sub> Mag.	S <sub>22</sub> Ang.	K Factor
0.1	0.102	176.3	22.9	14.04	-5.0	-31.1	0.028	-0.3	0.123	-6.8	1.5
0.2	0.098	175.4	23.0	14.07	-9.8	-31.4	0.027	0.0	0.121	-13.6	1.5
0.3	0.094	174.7	23.0	14.12	-14.7	-31.4	0.027	0.5	0.121	-19.7	1.5
0.4	0.089	173.9	23.0	14.15	-19.7	-31.4	0.027	1.4	0.121	-25.5	1.5
0.5	0.091	160.8	23.0	14.16	-24.7	-31.4	0.027	2.2	0.109	-25.3	1.5
0.6	0.089	156.2	23.0	14.20	-29.7	-31.4	0.027	3.3	0.105	-27.9	1.5
0.7	0.085	151.1	23.1	14.24	-34.7	-31.7	0.026	4.4	0.101	-30.3	1.5
0.8	0.080	146.0	23.1	14.29	-39.7	-31.7	0.026	5.7	0.096	-32.6	1.5
0.9	0.075	143.0	23.2	14.38	-44.9	-31.7	0.026	7.0	0.090	-35.0	1.5
1.0	0.071	138.4	23.2	14.44	-50.2	-31.7	0.026	8.1	0.084	-36.2	1.5
1.2	0.057	133.9	23.3	14.59	-60.8	-31.4	0.027	10.7	0.073	-37.6	1.5
1.4	0.046	135.0	23.4	14.72	-71.9	-31.4	0.027	13.4	0.060	-34.8	1.5
1.6	0.037	145.5	23.4	14.81	-83.6	-31.1	0.028	16.1	0.049	-22.7	1.4
1.8	0.035	164.3	23.2	14.53	-95.6	-31.1	0.028	18.4	0.049	-1.7	1.4
2.0	0.041	175.9	23.1	14.26	-108.1	-30.5	0.030	20.8	0.064	17.9	1.4
2.2	0.059	-176.2	23.1	14.23	-120.4	-30.2	0.031	22.5	0.083	17.7	1.3
2.4	0.073	-177.3	22.7	13.63	-132.9	-29.6	0.033	24.3	0.107	17.5	1.3
2.6	0.090	178.4	22.3	12.97	-144.9	-29.1	0.035	25.2	0.129	11.1	1.3
2.8	0.107	174.0	21.7	12.22	-156.4	-28.9	0.036	25.6	0.146	2.8	1.3
3.0	0.127	166.7	21.2	11.46	-167.4	-28.4	0.038	26.4	0.152	-5.4	1.3
3.2	0.139	160.7	20.6	10.68	-177.7	-27.7	0.041	26.0	0.162	-13.8	1.3
3.4	0.158	155.0	20.0	10.00	172.6	-27.5	0.042	25.4	0.163	-24.4	1.3
3.5	0.168	151.8	19.7	9.69	167.8	-27.3	0.043	25.6	0.159	-29.3	1.3
4.0	0.217	133.3	18.5	8.38	145.0	-26.4	0.048	24.7	0.137	-53.7	1.4
4.5	0.256	111.9	17.2	7.27	121.3	-25.0	0.056	24.1	0.099	-78.8	1.4
5.0	0.263	93.8	15.6	6.05	98.2	-23.9	0.064	21.0	0.069	-110.0	1.4
5.5	0.260	82.3	14.0	5.03	79.0	-22.6	0.074	15.8	0.068	-140.4	1.4
6.0	0.255	73.6	12.6	4.27	60.8	-21.5	0.084	9.4	0.093	-175.5	1.5

### ABA-54563 Typical Scattering Parameters

$T_c = +25^\circ\text{C}$ ,  $Z_0 = 50 \Omega$ ,  $V_{cc} = 5.5\text{V}$ , unless stated otherwise

Freq (GHz)	S <sub>11</sub> Mag.	S <sub>11</sub> Ang.	S <sub>21</sub> dB	S <sub>21</sub> Mag.	S <sub>21</sub> Ang.	S <sub>12</sub> dB	S <sub>12</sub> Mag.	S <sub>12</sub> Ang.	S <sub>22</sub> Mag.	S <sub>22</sub> Ang.	K Factor
0.1	0.105	176.6	23.0	14.05	-4.9	-31.1	0.028	-0.3	0.112	-6.8	1.4
0.2	0.101	176.2	23.0	14.08	-9.7	-31.1	0.028	-0.1	0.111	-13.6	1.5
0.3	0.098	175.5	23.0	14.13	-14.5	-31.1	0.028	0.4	0.111	-19.4	1.5
0.4	0.092	175.5	23.0	14.16	-19.4	-31.4	0.027	1.2	0.110	-25.1	1.5
0.5	0.095	163.2	23.0	14.18	-24.4	-31.4	0.027	2.0	0.099	-24.0	1.5
0.6	0.092	159.3	23.1	14.21	-29.3	-31.4	0.027	2.9	0.094	-26.0	1.5
0.7	0.088	154.6	23.1	14.26	-34.3	-31.4	0.027	4.0	0.090	-27.7	1.5
0.8	0.084	150.6	23.1	14.32	-39.2	-31.4	0.027	5.2	0.085	-29.1	1.5
0.9	0.079	148.1	23.2	14.41	-44.3	-31.4	0.027	6.4	0.080	-30.5	1.5
1.0	0.075	144.3	23.2	14.49	-49.5	-31.4	0.027	7.5	0.074	-30.4	1.5
1.2	0.063	142.7	23.3	14.65	-60.1	-31.4	0.027	9.9	0.063	-28.0	1.5
1.4	0.053	145.9	23.4	14.82	-71.1	-31.4	0.027	12.5	0.053	-19.7	1.4
1.6	0.048	155.7	23.5	14.94	-82.6	-31.1	0.028	15.1	0.050	-2.1	1.4
1.8	0.050	167.2	23.5	14.91	-94.5	-30.8	0.029	17.3	0.061	15.2	1.4
2.0	0.056	173.0	23.4	14.73	-107.0	-30.5	0.030	19.7	0.083	26.0	1.3
2.2	0.075	177.2	23.2	14.50	-119.5	-30.2	0.031	21.4	0.104	22.5	1.3
2.4	0.088	176.1	22.9	13.91	-131.8	-29.6	0.033	23.1	0.131	19.4	1.3
2.6	0.105	171.7	22.5	13.28	-143.9	-29.1	0.035	23.9	0.154	11.9	1.3
2.8	0.121	167.5	22.0	12.54	-155.5	-28.9	0.036	24.5	0.173	3.1	1.3
3.0	0.141	161.0	21.4	11.78	-166.6	-28.4	0.038	25.1	0.180	-5.7	1.3
3.2	0.153	155.0	20.8	10.99	-177.0	-28.0	0.040	24.8	0.190	-14.4	1.3
3.4	0.171	149.8	20.2	10.29	173.2	-27.5	0.042	24.3	0.192	-24.9	1.3
3.5	0.182	146.9	20.0	9.98	168.3	-27.3	0.043	24.5	0.187	-30.0	1.3
4.0	0.231	129.5	18.7	8.63	145.4	-26.6	0.047	23.9	0.165	-54.4	1.3
4.5	0.269	108.5	17.5	7.49	121.5	-25.4	0.054	23.9	0.126	-79.5	1.3
5.0	0.275	90.4	15.9	6.22	98.2	-24.0	0.063	21.3	0.092	-108.5	1.4
5.5	0.268	79.0	14.2	5.15	78.9	-22.7	0.073	16.4	0.088	-135.5	1.4
6.0	0.260	70.1	12.8	4.36	60.6	-21.6	0.083	10.3	0.108	-169.1	1.5

Refer to Agilent Web Site for S-parameters at different frequencies:

<http://www.agilent.com/view/rf>



## Device Models

Refer to Agilent's web site  
[www.agilent.com/view/rf](http://www.agilent.com/view/rf)

## Ordering Information

Part Number	Devices per Container	Container
ABA-54563-TR1G	3000	7" reel
ABA-54563-TR2G	10000	13" reel
ABA-54563-BLKG	100	antistatic bag

Note: Only lead-free option available.

## Package Dimensions

### Outline 63 (SOT-363/SC-70)

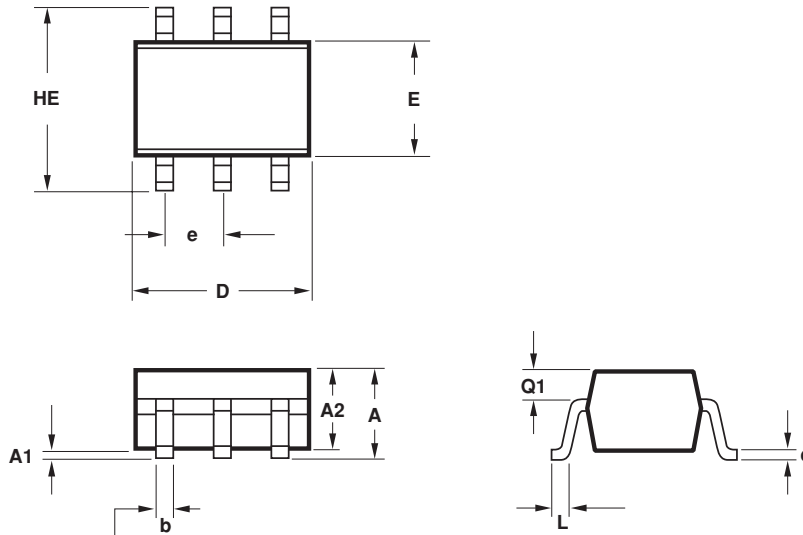

SYMBOL	DIMENSIONS (mm)	
	MIN.	MAX.
E	1.15	1.35
D	1.80	2.25
HE	1.80	2.40
A	0.80	1.10
A2	0.80	1.00
A1	0.00	0.10
Q1	0.10	0.40
e	0.650 BCS	
b	0.15	0.30
c	0.10	0.20
L	0.10	0.30

#### NOTES:

- All dimensions are in mm.
- Dimensions are inclusive of plating.
- Dimensions are exclusive of mold flash & metal burr.
- All specifications comply to EIAJ SC70.
- Die is facing up for mold and facing down for trim/form, ie: reverse trim/form.
- Package surface to be mirror finish.

## Recommended PCB Pad Layout for Agilent's SC70 6L/SOT-363 Products

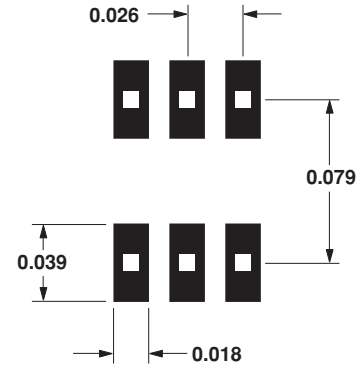

Dimensions in inches.

## Device Orientation

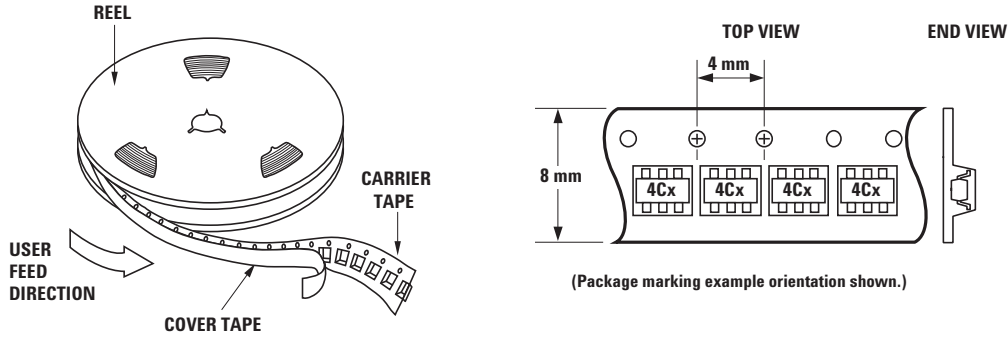

## Tape Dimensions and Product Orientation

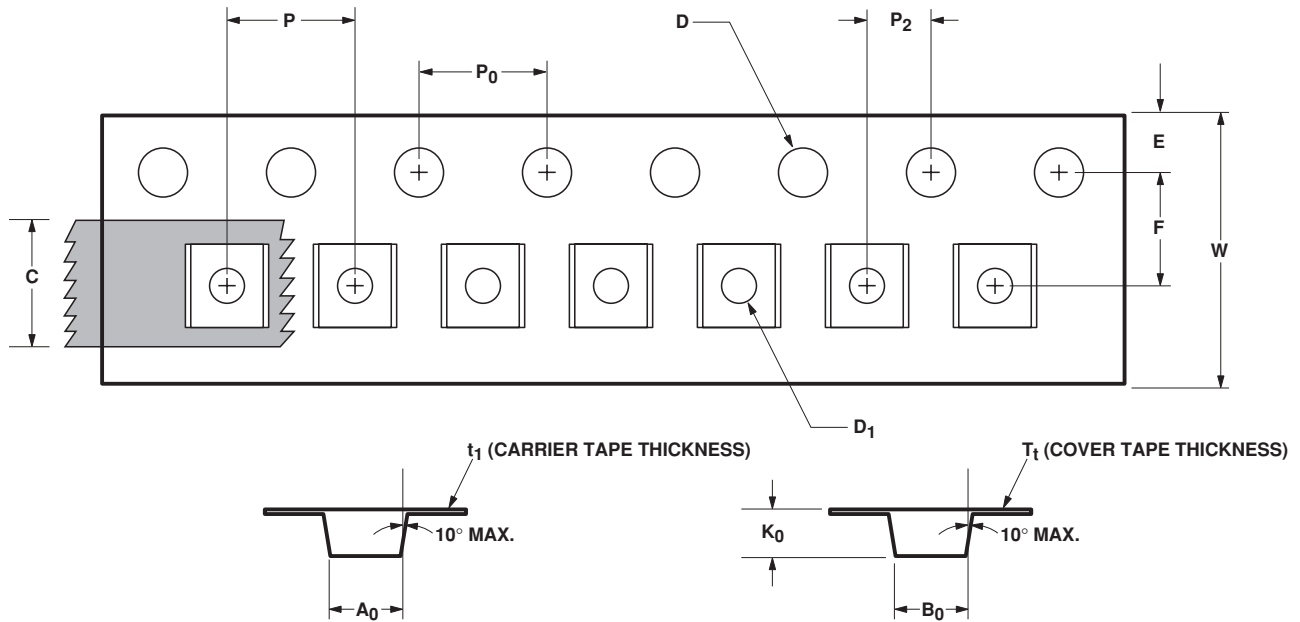

DESCRIPTION		SYMBOL	SIZE (mm)	SIZE (INCHES)
CAVITY	LENGTH	A <sub>0</sub>	2.40 ± 0.10	0.094 ± 0.004
	WIDTH	B <sub>0</sub>	2.40 ± 0.10	0.094 ± 0.004
	DEPTH	K <sub>0</sub>	1.20 ± 0.10	0.047 ± 0.004
	PITCH	P	4.00 ± 0.10	0.157 ± 0.004
	BOTTOM HOLE DIAMETER	D <sub>1</sub>	1.00 + 0.25	0.039 + 0.010
PERFORATION	DIAMETER	D	1.50 ± 0.10	0.061 + 0.002
	PITCH	P <sub>0</sub>	4.00 ± 0.10	0.157 ± 0.004
	POSITION	E	1.75 ± 0.10	0.069 ± 0.004
CARRIER TAPE	WIDTH	W	8.00 + 0.30 - 0.10	0.315 + 0.012
	THICKNESS	t <sub>1</sub>	0.254 ± 0.02	0.0100 ± 0.0008
COVER TAPE	WIDTH	C	5.40 ± 0.10	0.205 + 0.004
	TAPE THICKNESS	T <sub>t</sub>	0.062 ± 0.001	0.0025 ± 0.0004
DISTANCE	CAVITY TO PERFORATION (WIDTH DIRECTION)	F	3.50 ± 0.05	0.138 ± 0.002
	CAVITY TO PERFORATION (LENGTH DIRECTION)	P <sub>2</sub>	2.00 ± 0.05	0.079 ± 0.002

**[www.agilent.com/semiconductors](http://www.agilent.com/semiconductors)**

For product information and a complete list of distributors, please go to our web site.

For technical assistance call:

Americas/Canada: +1 (800) 235-0312 or  
(916) 788-6763

Europe: +49 (0) 6441 92460

China: 10800 650 0017

Hong Kong: (65) 6756 2394

India, Australia, New Zealand: (65) 6755 1939

Japan: (+81 3) 3335-8152(Domestic/International), or  
0120-61-1280(Domestic Only)

Korea: (65) 6755 1989

Singapore, Malaysia, Vietnam, Thailand, Philippines,  
Indonesia: (65) 6755 2044

Taiwan: (65) 6755 1843

Data subject to change.

Copyright © 2004 Agilent Technologies, Inc.

Obsoletes 5989-0884EN

December 4, 2004

5989-1973EN



**Agilent Technologies**