

369 Series, TE5® Time-Lag Fuse

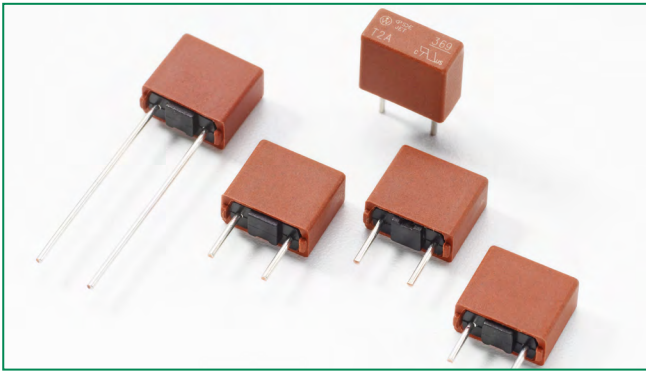

Description

The 369 Series are TE5® Time-Lag Fuses, 300V rated and designed in accordance to IEC 60127-3.





Features

- Halogen free, Lead-free and RoHS compliant
- Reduced PCB space requirements
- Direct solderable or plug-in versions
- Internationally approved
- Low internal resistance
- Shock safe casing
- Vibration resistant

Applications

- Electronic Ballast

Agency Approvals

Agency	Agency File Number	Ampere Range
	E67006	0.800A - 6.3A
	JET 1896-31007-2002	1A - 5A
	1605793	1A - 6.3A
	40037351	1A, 1.6A - 2A, 3.15A - 6.3A

Electrical Characteristics

% of Ampere Rating	Opening Time
150%	1 Hour, Minimum
210%	120 sec., Maximum
275%	400 ms., Min.; 10 sec., Max.
400%	150 ms., Min.; 3 sec., Max.
1000%	20 ms., Min.; 150 ms., Max.

Additional Information



Datasheet







Resources



Samples

Electrical Characteristics

Amp Code	Amp Rating (A)	Voltage Rating (V)	Breaking Capacity	Nominal Cold Resistance (Ohms)	Voltage Drop $1.0 \times I_N$ max. (mV)	Power Dissipation $1.5 \times I_N$ max. (mW)	Melting Integral $10 \times I_N$ max. (A ² s)	Agency Approvals			
											
0800	0.800	300	50A @300VAC	0.0960	110	280	5.1200	x			
1100	1.00	300		0.0715	115	400	8.0000	x	x	x	x
1160	1.60	300		0.0400	95	600	18.4320	x	x	x	x
1200	2.00	300		0.0298	90	700	29.0000	x	x	x	x
1315	3.15	300		0.0170	80	1100	78.3880	x	x	x	x
1400	4.00	300		0.0128	75	1200	126.4000	x	x	x	x
1500	5.00	300		0.0101	70	1000	106.2500	x	x	x	x
1630	6.30	300		0.0077	65	1200	160.7400	x		x	x

Note:
1. Resistance is measured at 10% of rated current, 25°C.

Temperature Re-rating Curve

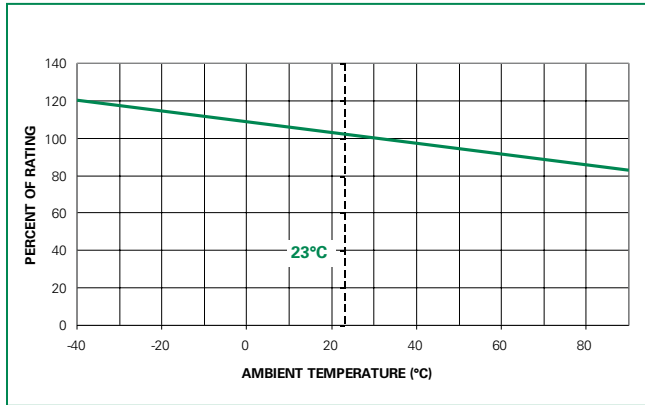

Note:
1. Rerating depicted in this curve is in addition to the standard derating of 25% for continuous operation.

Average Time Current Curves

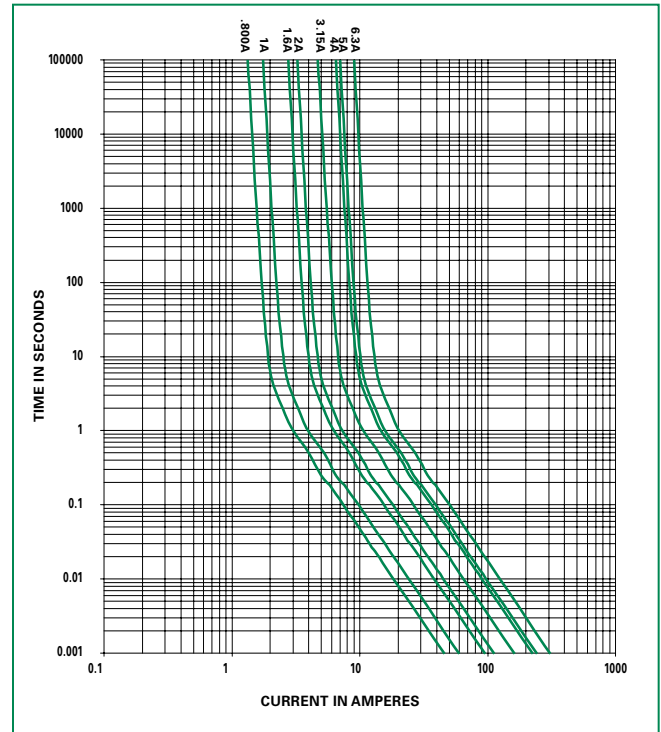

Soldering Parameters - Wave Soldering

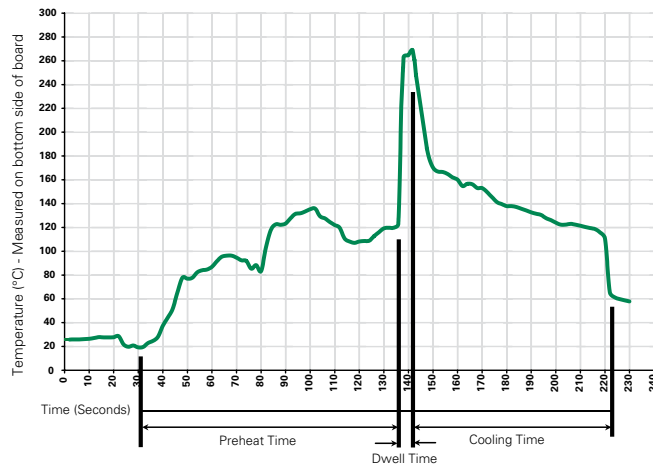

Recommended Process Parameters:

Wave Parameter	Lead-Free Recommendation
Preheat: (Depends on Flux Activation Temperature)	(Typical Industry Recommendation)
Temperature Minimum:	100°C
Temperature Maximum:	150°C
Preheat Time:	60-180 seconds
Solder Pot Temperature:	260°C Maximum
Solder Dwell Time:	2-5 seconds

Recommended Hand-Solder Parameters:

Solder Iron Temperature: 350°C +/- 5°C
Heating Time: 5 seconds max.

Note: These devices are not recommended for IR or Convection Reflow process.

Product Characteristics

Materials	Base/Cap: Black/Brown Thermoplastic Polyamide PA 6.6, UL 94 V0 Round Pins: Tin-plated Copper
Lead Pull Strength	10N (IEC 60068-2-21)
Solderability	260°C, ≤ 3s. (Wave) 350°C, ≤ 1s. (Soldering Iron)
Soldering Heat Resistance	260°C, 10s. (IEC 60068-2-20) 350°C, 3s. (Soldering Iron)

Operating Temperature	-40°C to +85°C (consider re-rating)
Climatic Category	-40°C to +85°C/21 days (IEC 60068-1,-2-1,-2-2,-2-78)
Stock Conditions	+10°C to +60°C RH, ≤ 75% yearly average, without dew, maximum value for 30 days-95%
Vibration Resistance	24 cycles at 15 min. each (IEC 60068-2-6) 10 - 60Hz at 0.75mm amplitude 60 - 2000Hz at 10g acceleration

Dimensions

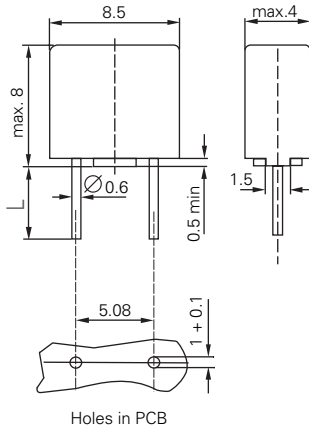

Long Leads (L=18.8mm)
Short Leads (L=4.3mm)

Part Numbering System

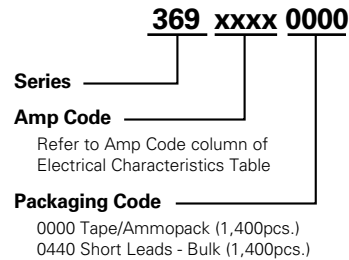

Packaging

Packaging Option	Packaging Specification	Quantity	Quantity & Packaging Code	Taping Width
369 Series				
Tape & Ammopack	N/A	1,400	0000	N/A
Short Leads	N/A	1,400	0440	N/A