

Axial Lead & Cartridge Fuses

5x20 mm > Time-Lag > 215 Series

215 Series, 5x20 mm, Time-Lag Fuse



Agency Approvals

| Agency | Agency File Number | Ampere Range |
|--------|---|------------------------------------|
| | Cartridge: NBK080205-E10480A NBK250702-E10480E NBK100408-JP1021A | 1A – 5A 6.3A – 15A 16A – 20A |
| | Leaded: NBK080205-E10480B NBK250702-E10480F NBK100408-JP1021B | 1A – 5A 6.3A – 15A 16A – 20A |
| | 2005010207145714 | 1A – 6.3A |
| | CQC07012021808 | 8A – 10A |
| | SU05001-2011B | 1A – 2.5A |
| | SU05001-10001 | 3.15A – 6.3A |
| | SU05001-10002 | 8A |
| | SU05001-2012B | 4A – 10A |
| | E10480 | 0.125A - 20A |
| | 29862 | 0.5A – 12A |
| | 1517218 | 0.125A-12A |
| | | 15A*, 16A*, 20A* |
| | 40013521 | 0.2A – 8A *10A |
| | 40016610 | *12A |
| | KM41462 | 0.200A – 10A |
| | J50258578 | 16A/20A |
| | N/A | 0.125A – 20A |

* Approved for cartridge versions only

Description

5x20mm Time-Lag surge withstand ceramic body cartridge fuse designed to IEC specification

Features

- Designed to International (IEC) Standards for use globally
- High breaking capacity
- Meets the IEC 60127-2, Sheet 5 specification for Time-Lag fuses
- RoHS compliant and lead-free

Applications

Used as supplementary protection in appliance or utilization equipment to provide individual protection for components or internal circuits.

Additional Information



Datasheet



Resources



Samples

Electrical Characteristics for Series

| % of Ampere Rating | Ampere Rating | Opening Time |
|--------------------|-----------------|---------------------------------|
| 150% | 0.125A – 0.800A | 60 minutes, Minimum |
| | 1A – 3.15A | 60 minutes, Minimum |
| | 4A – 6.3A | 60 minutes, Minimum |
| | 8A – 20A | 30 minutes, Minimum |
| 210% | 0.125A – 0.800A | 30 minutes, Maximum |
| | 1A – 3.15A | 30 minutes, Maximum |
| | 4A – 6.3A | 30 minutes, Maximum |
| | 8A – 20A | 30 minutes, Maximum |
| 275% | 0.125A – 0.800A | .25 sec. Min.; 80 secs. Max. |
| | 1A – 3.15A | .75 sec. Min.; 80 secs. Max. |
| | 4A – 6.3A | .75 sec. Min.; 80 secs. Max. |
| | 8A – 20A | .75 sec. Min.; 80 secs. Max. |
| 400% | 0.125A – 0.800A | .05 sec., Min.; 5 secs. Max. |
| | 1A – 3.15A | .095 sec., Min.; 5 secs. Max. |
| | 4A – 6.3A | .150 sec., Min.; 5 secs. Max. |
| | 8A – 20A | .150 sec., Min.; 5 secs. Max. |
| 1000% | 0.125A – 0.800A | .005 sec., Min.; .150 sec. Max. |
| | 1A – 3.15A | .010 sec., Min.; .150 sec. Max. |
| | 4A – 6.3A | .010 sec., Min.; .150 sec. Max. |
| | 8A – 20A | .010 sec., Min.; .150 sec. Max. |

Electrical Characteristic Specifications by Item

| Amp Code | Amp Rating | Voltage Rating (V) | Interrupting Rating | Nominal Cold Resistance (Ohms) | Nominal Melting I ² t (A ² sec) | Maximum Voltage Drop at Rated Current (mV) | Maximum Power Dissipation at 1.5I _n (W) | Agency Approvals | | | | | | | | | | | | | | | |
|----------|------------|--------------------|---------------------|--------------------------------|---|--|--|------------------|-----|----|----|----|----|----|----|----|----|----|----|--|---|---|---|
| | | | | | | | | UL | CSA | UL | UL | UL | UL | UL | UL | UL | UL | UL | UL | | | | |
| .125 | 0.125 | 250 | 1500 A @ 250 VAC | 11.4455 | 0.0330 | 2600 | 1.6 | | | | | | | x | | x | | | | | | x | |
| .160 | 0.16 | 250 | | 7.1000 | 0.0465 | 2400 | 1.6 | | | | | | | | x | | x | | | | | | x |
| .200 | 0.2 | 250 | | 1.8400 | 0.340 | 2100 | 1.6 | x | | | | | | | x | | x | x | | | | | x |
| .250 | 0.25 | 250 | | 1.2400 | 0.545 | 1500 | 1.6 | x | | | | | | | x | | x | x | | | | | x |
| .315 | 0.315 | 250 | | 0.8800 | 0.975 | 1100 | 1.6 | x | | | | | | | x | | x | x | | | | | x |
| .400 | 0.4 | 250 | | 0.5825 | 1.325 | 1000 | 1.6 | x | | | | | | | x | | x | x | | | | | x |
| .500 | 0.5 | 250 | | 1.1675 | 0.420 | 850 | 1.6 | x | | | | | | | x | x | x | x | | | | | x |
| .630 | 0.63 | 250 | | 0.7200 | 0.635 | 650 | 1.6 | x | | | | | | | x | x | x | x | | | | | x |
| .800 | 0.8 | 250 | | 0.4675 | 0.975 | 500 | 1.6 | x | | | | | | | x | x | x | x | | | | | x |
| 001. | 1 | 250 | | 0.1515 | 1.520 | 350 | 2.5 | x | x | x | x | x | x | x | x | x | x | x | | | | | x |
| 1.25 | 1.25 | 250 | | 0.1074 | 3.200 | 300 | 2.5 | x | x | x | x | x | x | x | x | x | x | x | | | | | x |
| 01.6 | 1.6 | 250 | | 0.0707 | 6.830 | 200 | 2.5 | x | x | x | x | x | x | x | x | x | x | x | | | | | x |
| 002. | 2 | 250 | | 0.0566 | 11.680 | 190 | 2.5 | x | x | x | x | x | x | x | x | x | x | x | | | | | x |
| 02.5 | 2.5 | 250 | | 0.0386 | 22.290 | 180 | 2.5 | x | x | x | x | x | x | x | x | x | x | x | | | | | x |
| 3.15 | 3.15 | 250 | | 0.0283 | 43.255 | 140 | 4 | x | x | x | x | x | x | x | x | x | x | x | | | | | x |
| 004. | 4 | 250 | | 0.0185 | 46.960 | 100 | 4 | x | x | x | x | x | x | x | x | x | x | x | | | | | x |
| 005. | 5 | 250 | | 0.0153 | 66.095 | 100 | 4 | x | x | x | x | x | x | x | x | x | x | x | | | | | x |
| 06.3 | 6.3 | 250 | | 0.0108 | 128.750 | 100 | 4 | x | x | x | x | x | x | x | x | x | x | x | | | | | x |
| 008. | 8 | 250 | | 0.0092 | 209.880 | 100 | 4 | x | x | | x | x | x | x | x | x | x | x | | | x | | x |
| 010. | 10 | 250 | | 0.0066 | 333.565 | 100 | 4 | x | x | | x | x | x | x | x | x | x | x | | | x | | x |
| 012. | 12 | 250 | 0.0061 | 515.500 | 100 | 4 | | x | | | x | x | x | | | | x | | | | | x | |
| 015. | 15 | 250 | 0.0033 | 1237.0 | N/A** | N/A** | | x | | | | x | | | x | | | | | | | x | |
| 016. | 16 | 250 | 0.0031 | 1408.0 | N/A** | N/A** | | x | | | | x | | | x | | | | | | x | x | |
| 020. | 20 | 250 | 0.0023 | 2600.0 | N/A** | N/A** | | x | | | | x | | | x | | | | | | x | x | |

X* Approval for cartridge versions only
 N/A** - Please contact Littelfuse for details on these parameters
 1A to 2A have an IR : 100A@500VAC, 4A to 6-3A have the IR : 100A@305 VAC and 1000A@72VDC
 I²t test at 10x rated current.

Temperature Re-rating Curve

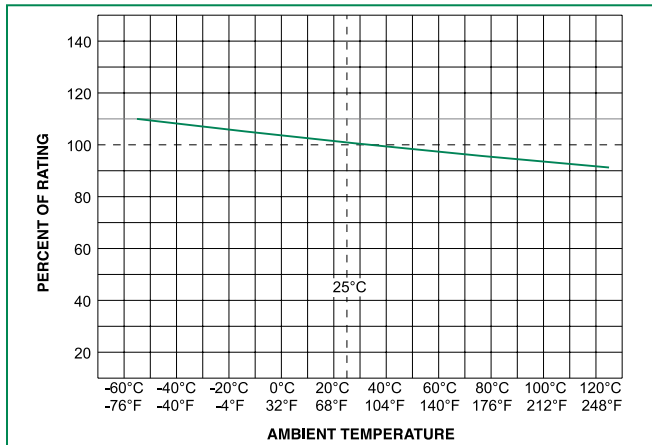

Product Characteristics

| | |
|------------------------------|--|
| Materials | Body: Ceramic Cap: Nickel-plated Brass Leads: Tin-plated Copper |
| Terminal Strength | MIL-STD-202, Method 211, Test Condition A |
| Solderability | MIL-STD-202 Method 208 |
| Product Marking | Cap 1: Brand logo, current and voltage ratings Cap 2: Agency approval markings |
| Operating Temperature | -55°C to +125°C |
| Thermal Shock | MIL-STD-202, Method 107, Test Condition B (5 cycles, -65°C to +125°C) |
| Vibration | MIL-STD-202, Method 201 |
| Humidity | MIL-STD-202, Method 103, Test Condition A (High RH (95%) and elevated temp (40°C) for 240 hours) |
| Salt Spray | MIL-STD-202, Method 101, Test Condition B |

Average Time Current Curves

T-C Curves for 125mA to 800mA only

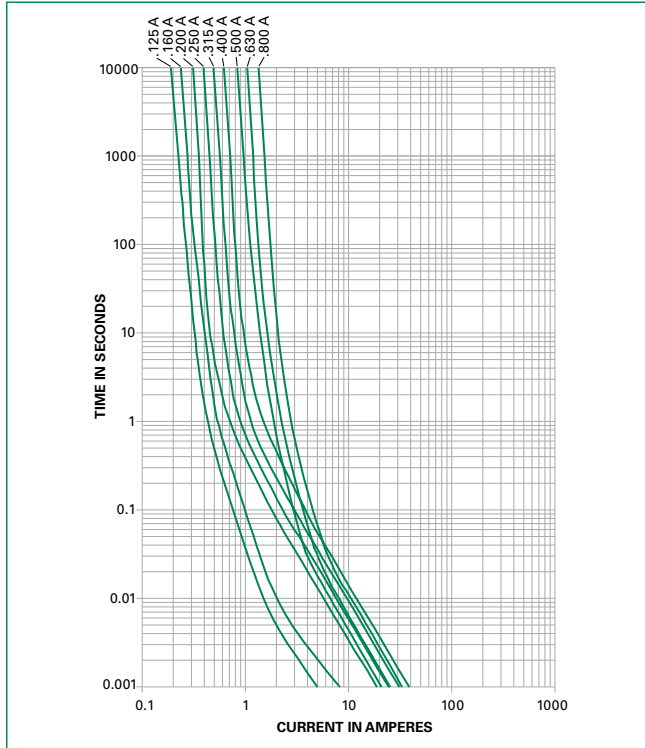

T-C Curves for 1A to 20A only

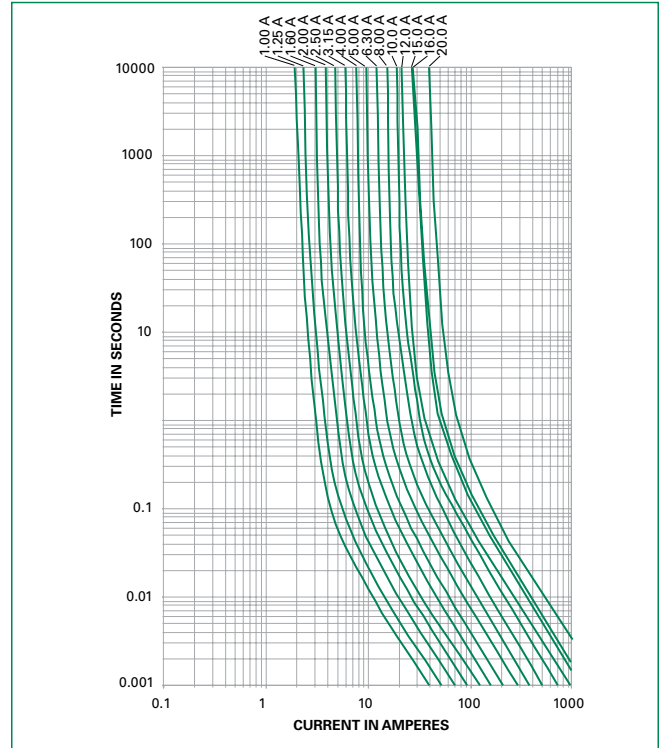

Soldering Parameters - Wave Soldering

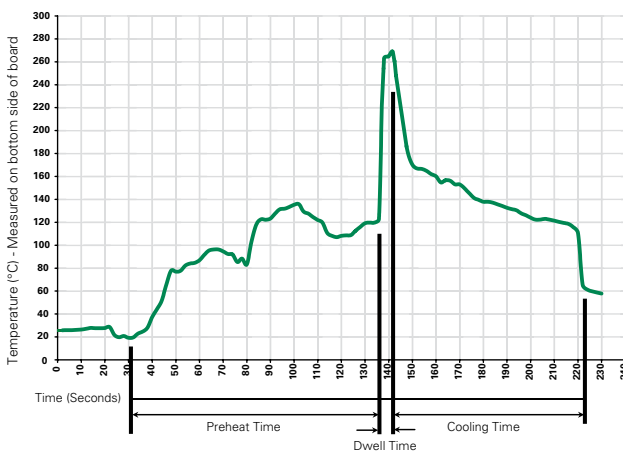

Recommended Process Parameters:

| Wave Parameter | Lead-Free Recommendation |
|---|--------------------------|
| Preheat: (Depends on Flux Activation Temperature) (Typical Industry Recommendation) | |
| Temperature Minimum: | 100° C |
| Temperature Maximum: | 150° C |
| Preheat Time: | 60-180 seconds |
| Solder Pot Temperature: | 260° C Maximum |
| Solder Dwell Time: | 2-5 seconds |

Recommended Hand-Solder Parameters:

Solder Iron Temperature: 350° C +/- 5° C
 Heating Time: 5 seconds max.

Note: These devices are not recommended for IR or Convection Reflow process.

Different values of A and B available, please contact the Littelfuse sales representative in your region:

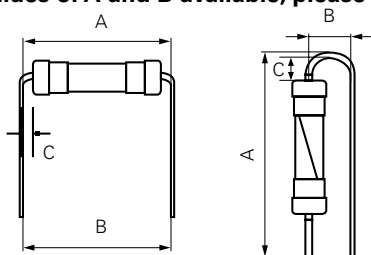

For the pigtailed fuse, please follow the recommendations below for axial lead forming and mounting into PCB:

Lead forming:

The distance C between cap flat surface and axial lead shall be greater than 1.0 mm.

PCB mounting:

The distance between PCB and fuse cap is recommended to be a minimum of 1.5 mm.

Dimensions

All dimensions in mm

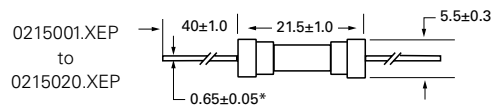
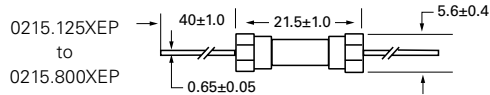
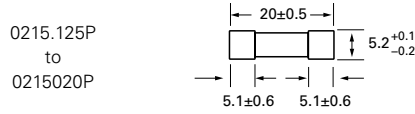

Notes:
* Ratings above 6.3 A have 0.8 ± 0.05 diameter lead;
* Ratings above 12 A have 1.2 ± 0.05 diameter lead.

Part Numbering System

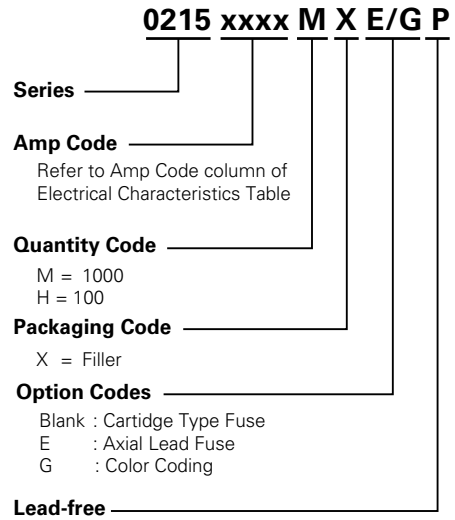

Packaging

| Packaging Option | Packaging Specification | Quantity | Quantity & Packaging Code | Taping Width |
|-----------------------|-------------------------|----------|---------------------------|------------------|
| 215 Series | | | | |
| Bulk | N/A | 1000 | MX | N/A |
| Bulk | N/A | 1000 | MXE | N/A |
| Reel and Tape | N/A | 1000 | MRET1 | T1=53mm (2.087") |
| Bulk and Color Coding | N/A | 1000 | MXG | N/A |
| Bulk | N/A | 1000 | MXB | N/A |
| Bulk | N/A | 100 | HX | N/A |