

Passive components Sales Office

MULTILAYER CERAMIC CAPACITORS

• Head Office

206, Cheomdansaneop Road,
Youngtong-gu,
Suwon, Kyonggi Province 443-743,
Korea

Europe

Tel: +82-31-210-6328
E-mail: james.pyun@samsung.com

America

Tel: +82-31-210-6794
E-mail: randy.kim@samsung.com

Asia

Tel: +82-31-210-5348
E-mail: koogi@samsung.com

Domestic

Tel: +82-31-210-3757
E-mail: southjoy@samsung.com

• Manufacturing Site

Suwon Plant (Korea)

206 Cheomdansaneop Road,
Youngtong-gu,
Suwon, Kyonggi Province 443-743,
Korea
Tel: +82-31-210-6794
E-mail: randy.kim@samsung.com

Busan Plant (Korea)

1623-2, Songjeong-dong,
Kangseo-gu, Busan 618-270, Korea
Tel: +82-51-970-7671
E-mail: kyc.kweon@samsung.com

Tianjin Plant (China)

27, Heiniucheng-Road, Hexi District,
Tianjin, China 300210
Tel: +86-22-2830-3333(3450)
E-mail: gk.ryu@samsung.com

Philippines Plant (Philippines)

Calamba Premiere International Park,
Batino, Calamba, Laguna, Manila
Tel: +63-2-809-2873
E-mail: ksj1445@samsung.com

• Asia sales office

Shanghai Office

Rm 1408 Shanghai international
trade center No 2200 Yan an(W) RD
Shanghai China 200335
Tel: 86-21-6270-4168(274)
E-mail: dennis.cha@samsung.com

Shenzhen Office

Rm 4501, 45/F, New World Center,
Yitian Road, Futian District,
Shenzhen, China 518026
Tel: 86-755-8608-5581
E-mail: jackson.xian@samsung.com

Qingdao Office

Rm 1201, Growne Plaza Qingdao;
76XiangGangZhong Rd, Qingdao;266071
P.R. China
Tel: 86-532-5779102
E-mail: zhengguo.cui@samsung.com

HongKong Office

Suite 4511, Two int'l Finance Centre,
8 Finance Street, Central, Hongkong
Tel: 852-2862-6350
E-mail: vinsent.chou@samsung.com

Singapore Office

3 Church Street Samsung Hub
#23-02 Singapore 049483
Tel: (65)6833-3228
E-mail: winson.yeong@samsung.com

Thai Office

Wellgrow Industrial Estate,
93 Moo 5 T. Bangsamak, A.Bangpakong
Chachoengsao 24180 Thailand
Tel: 66-38-562-026
E-mail: sbimm@samsung.com

Taiwan Office

399 9F-1, Ruey Kuang Rd., Neihu,
Taipei, Taiwan
Tel: 886-2-2656-8356
E-mail: kevin0130.wang@samsung.com

• America sales office

Irvine Office

3345 Michelson Drive,
Suite 350, Irvine, CA 92612
Tel: 1-949-797-8047
E-mail: sh386.kim@samsung.com

• Europe sales office

Frankfurt Office

Samsung haus
Am Kronberger Hang 6
D-65824 Schwalbach/Ts.
Tel: 49-6196-66-7255
FAX: 49-(0)6196-66-7755
E-mail: frank.goebel@samsung.com

Hungary Office

H2310, Szigetszentmiklos, Leshegy u.
2-4, Hungary
Tel: 36-24-551-148
E-mail: jun21c.lee@samsung.com

• Domestic Distributors

KORCHIP INC

#219-8 Gasan-dong, Gumchun-gu,
Seoul, Korea
Tel: +82-2-838-5588
E-mail: hjh0064@korchip.com

CHUNG HAN

#16-96 Hangang-lo 3, Youngsan-Gu,
Seoul, Korea
Tel: +82-2-718-3322
E-mail: bu1230choi@hanmail.net

SAMT

Daekyung Bldg., Daechi-Dong,
Gangnam-Gu, Seoul, Korea
Tel: +82-2-3458-9000
E-mail: info@isamt.com

CHUNGMAC

#53-5 Wonhyolo3 Youngsan-gu,
Seoul, Korea
Tel: +82-2-716-6428~9
E-mail: webmaster@anycam.co.kr

APEXINT

Room #905, C-dong Woorimlion's,
Valley 371-28, Gasan-dong,
Guemcheon-Gu, Seoul, Korea
Tel: +82-2-2026-2610(2)
E-mail: info@apexint.co.kr





We, Samsung, declare that our component MLCC is produced in accordance with EU RoHS directive.

1. RoHS Compliance and restriction of Br

The following restricted materials are not used in packaging materials as well as products in compliance with the law and restriction.
 - Cd, Pb, Hg, Cr+6, As, Br and the compounds, PCB, asbestos
 - Bromic materials : PBBs, PBBOs, PBDO, PBDE, PBB

2. No use of materials breaking Ozone layer

The following ODS materials are not used in our fabrication process.
 - ODS material : Freon, Haron, 1-1-1 TCE, CCl4, HCFC

If you want more detailed Information, Please Visit Samsung Electro-mechanics Website <http://www.sem.samsung.com>

Please, see the last page of this catalog for our environmental certification list.

CONTENTS

Part Numbering System	4	Part Numbering System
General Capacitors	6	General Capacitors
Ultra High Capacitors	28	Ultra High Capacitors
Super Small Capacitors	35	Super Small Capacitors
High Voltage Capacitors	39	High Voltage Capacitors
Camera Strobe Circuit Capacitors	50	Camera Strobe Circuit Capacitors
Array Type Capacitors	52	Array Type Capacitors
Low ESL Capacitors	55	Low ESL Capacitors
Reliability Test Condition	58	Reliability Test Condition
Premium Capacitors for Automotive Applications	62	Premium Capacitors for Automotive Applications
Packaging Specification	79	Packaging Specification
Application Manual for Surface Mounting	83	Application Manual for Surface Mounting

CL 10 C 101 J B 8 N N N C
1 2 3 4 5 6 7 8 9 10 11

1. SERIES CODE

CL=Multi layer Ceramic Capacitors

2. SIZE CODE

inch(mm)
02=01005(0402) 21=0805(2012) 43=1812(4532)
03=0201(0603) 31=1206(3216) 55=2220(5750)
05=0402(1005) 32=1210(3225)
10=0603(1608) 42=1808(4520)

3. DIELECTRIC CODE

Class I			Class II		
C=C0G	S=S2H	L=S2L	A=X5R	F=Y5V	
P=P2H	T=T2H		B=X7R	X=X6S	
R=R2H	U=U2J		Y=X7S		

4. CAPACITANCE CODE

Capacitance expressed in pF. 2 significant digits plus number of zeros.
example) 106=10 × 10⁶=1000000pF
For Values < 10pF, Letter R denotes decimal point
example) 1R5=1.5pF

5. TOLERANCE CODE

A=±0.05pF D=±0.5pF J=±5% Z=+80/-20%
B=±0.1pF F=±1pF, ±1%* K=±10%
C=±0.25pF G=±2% M=±20%

*For Values ≤ 10pF, F=±1pF
Values > 10pF, F=±1%

6. RATED VOLTAGE CODE

R=4V O=16V B=50V E=250V H=630V K=3000V
Q=6.3V A=25V C=100V F=350V I=1000V
P=10V L=35V D=200V G=500V J=2000V

7. THICKNESS CODE

3 = 0.30mm A = 0.65mm F = 1.25mm L = 3.20mm S = 1.35mm
5 = 0.50mm C = 0.85mm H = 1.60mm M = 1.15mm U = 1.80mm
8 = 0.80mm D = 1.00mm I = 2.00mm P = 1.15mm V = 2.50mm
9 = 0.90mm E = 1.10mm J = 2.50mm Q = 1.25mm Y = 1.25mm

8. INNER ELECTRODE / TERMINATION / PLATING CODE

A= Normal Product Pd / Ag / Ni barrier / Sn 100%
N= Normal Product Ni / Cu / Ni barrier / Sn 100%
G= Normal Product Cu / Cu / Ni barrier / Sn 100%
L= Low profile Ni / Cu / Ni barrier / Sn 100%
S= Normal Product Ni/Cu/Ag-Epoxy/Ni barrier / Sn 100%

9. PRODUCT CODE

A= Array(2-element) L= LICC
B= Array(4-element) N= Normal
C= Low ESL (Please refer to p. 6 for application.)

Size Code	*Size tolerance		
	0402(1005)	0603(1608)	0805(2012)
S	±0.07	±0.07	
Q	±0.1	±0.15	±0.15
R	±0.15	±0.2	±0.2

10. SPECIAL CODE

N= Reserved for future use

11. PACKAGING CODE

B= Bulk O= Cardboard Tape, 10" Reel E= Embossed Type, 7" Reel
P= Bulk Case D= Cardboard Tape, 13" Reel(10,000ea) F= Embossed Type, 13" Reel
C= Cardboard Tape, 7" Reel L= Cardboard Tape, 13" Reel(15,000ea) S= Embossed Type, 10" Reel

Class I (Temperature Compensation)

Symbol	EIA Code	Operation Temperature Range(°C)	Temperature Coefficient Range(ppm/°C)
C	C0G	-55 ~ +125	0 ±30
P	P2H	-55 ~ +125	-150 ±60
R	R2H	-55 ~ +125	-220 ±60
S	S2H	-55 ~ +125	-330 ±60
T	T2H	-55 ~ +125	-470 ±60
U	U2J	-55 ~ +125	-750 ±120
L	S2L	-55 ~ +125	-1000 ~ +350

Class II (High Dielectric Constant)

Symbol	EIA Code	Operation Temperature Range(°C)	Capacitance Change(ΔC %)
A	X5R	-55 ~ +85	±15
B	X7R	-55 ~ +125	±15
X	X6S	-55 ~ +105	±22
F	Y5V	-30 ~ +85	-82 ~ +22
Y	X7S	-55 ~ +125	±22

**

Series	TC	Capacitance Step											
E-3	Y5V	1.0			2.2			4.7					
E-6	X5R X7R X6S	1.0	1.5		2.2	3.3		4.7		6.8			
E-12	COG TC series	1.0	1.2	1.5	1.8	2.2	2.7	3.3	3.9	4.7	5.6	6.8	8.2

Size	Code	Thickness(mm)	Spec(mm)	Size	Code	Thickness(mm)	Spec(mm)
01005(0402)	2	0.20	±0.02	1210(3225)	H	1.60	±0.20
0201(0603)	3	0.30	±0.03		U	1.80	±0.20
0402(1005)	5	0.50	±0.05		I	2.00	±0.20
0603(1608)	5	0.50	±0.05	J	2.50	±0.20	
	8	0.80	±0.10	V	2.50	±0.30	
0805(2012)	A	0.65	±0.10	1808(4520)	F	1.25	±0.20
	C	0.85	±0.10		H	1.60	±0.20
	D	1.00	±0.15		I	2.00	±0.20
	F	1.25	±0.10	1812(4532)	F	1.25	±0.20
	Q	1.25	±0.15		H	1.60	±0.20
	Y	1.25	±0.2		I	2.00	±0.20
1206(3216)	C	0.85	±0.15	2220(5750)	I	2.00	±0.20
	D	1.00	±0.15		J	2.50	±0.20
	E	1.10	±0.10		L	3.20	±0.30
	P	1.15	±0.10	1210(3225)	F	1.25	±0.20
	F	1.25	±0.15		H	1.60	±0.20
	H	1.60	±0.20		I	2.00	±0.20
1210(3225)	C	0.85	±0.10	J	2.50	±0.20	
	9	0.90	±0.10	L	3.20	±0.30	
	E	1.10	±0.10				
	M	1.15	±0.10				
	F	1.25	±0.20				
S	1.35	±0.15					

- Part Numbering System
- General Capacitors
- Ultra High Capacitors
- Super Small Capacitors
- High Voltage Capacitors
- Camera Strobe Circuit Capacitors
- Array Type Capacitors
- Low ESL Capacitors
- Reliability Test Condition
- Premium Capacitors for Automotive Applications
- Packaging Specification
- Application Manual for Surface Mounting

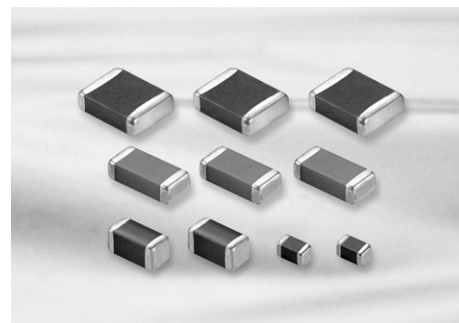

Feature

- Wide selection of size : from 0402 to 2220
- Highly reliable tolerance and high speed automatic chip placement on PCBs
- Wide capacitance range
- Wide temperature compensation and voltage range : from COG to Y5V and from 6.3V to 50V
- Highly reliable performance
- Highly resistant termination metal
- Tape & reel for surface mount assembly

Application

- HHP, DSC, DVC, LCD, TV, Car Navigation, Memory Module, PDA, Game Machine
- Tuner (Product code C is suitable.)
- ※ For using special purpose like Military, Medical, Aviation, Automobile device should be following a special specification.

Structure and Dimensions

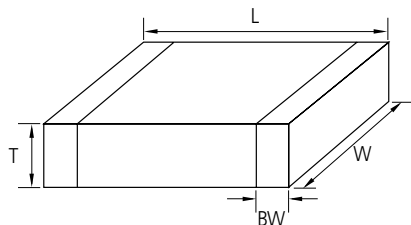

Size Code	EIA Code	Dimension(mm)						
		L	W	T	Thickness Code	BW		
05	0402	1.00±0.05	0.50±0.05	0.50±0.05	5	0.2+0.15/-0.1		
10	0603	1.60±0.10	0.80±0.10	0.50±0.05	5	0.30±0.20		
				0.80±0.10	8			
21	0805	2.00±0.10	1.25±0.10	0.85±0.10	C	0.5+0.2/-0.3		
				1.25±0.10	F			
				2.00±0.15	1.25±0.15		1.25±0.15	Q
				2.00±0.20	1.25±0.20		1.25±0.20	Y
31	1206	3.20±0.20	1.60±0.20	0.60±0.10	6	0.50+0.30		
				0.85±0.10	C			
				1.15±0.10	P			
				3.20±0.15	1.60±0.15		1.25±0.15	F
32	1210	3.20±0.30	2.50±0.20	1.60±0.20	H	0.60±0.30		
				1.80±0.20	U			
				2.00±0.20	I			
				2.50±0.20	J			
				2.50±0.30	v			
				3.20±0.40	2.50±0.30		2.50±0.30	
42	1808	4.50±0.40	2.00±0.20	2.00±0.20	I	0.80±0.30		
43	1812	4.50±0.40	3.20±0.30	3.20±0.30	L	0.80±0.30		
55	2220	5.70±0.40	5.00±0.40	3.20±0.30	L	1.00±0.30		

■ Pd MLCC (12th code in part number of pd MLCC = A)

- Class I type
Capacitance < 10pF (Class I. 0402, 0603, 0805 case size)
Capacitance < 18pF (Class I. 1206 case size)

* Except the capacitance range mentioned as above, All other the capacitance range is using Ni inner electrode for Class I, Class II type (12th code in part number of Ni MLCC = N)

Capacitance Table (General Capacitors)

Size	0402(05)	0603(10)	0805(21)	1206(31)	1210(32)	1812(43)	2220(55)
	COG(C)						
TC	COG(C)						
Rated V	50(B)	50(B)	50(B)	25(A)	50(B)	50(B)	25(A)
Capacitance -pF- (part numbering code) and thickness -mm-							
0.2(0R2)							
0.5(0R5)							
1(010)							
10(100)							
12(120)							
18(180)							
22(220)							
33(330)							
39(390)							
47(470)	0.5 (5)						
56(560)							
100(101)							
150(151)							
180(181)							
220(221)							
270(271)							
330(331)							
390(391)							
470(471)							
560(561)			0.65 (A)				
680(681)							
820(821)							
1000(102)							
1200(122)		0.8 (8)					
1500(152)							
1800(182)							
2200(222)							
2700(272)							
3300(332)							
3900(392)							
4700(472)							
5600(562)			1.25 (F)				
6800(682)							
8200(822)							
10000(103)				1.25 (F)			
12000(123)							
15000(153)							
18000(183)							
22000(223)							
27000(273)							
33000(333)							
39000(393)							
43000(433)				1.6 (H)		2.0 (I)	
47000(473)							
56000(563)							2.5 (J)
68000(683)							
100000(104)						1.6 (H)	
120000(124)							2.5 (J)

■ :X7R(B) ■ :X5R(A) ■ :Y5V(F) ■ :COG(C) ■ :X6S(X)

Part Numbering System

General Capacitors

Ultra High Capacitors

Super Small Capacitors

High Voltage Capacitors

Camera Strobe Circuit Capacitors

Array Type Capacitors

Low ESL Capacitors

Reliability Test Condition

Premium Capacitors for Automotive Applications

Packaging Specification

Application Manual for Surface Mounting

Capacitance Table (General Capacitors)

Size	0402(05)			0603(10)					0805(21)				
	U2J(U)/S2L(L)	T2H(T)	R2H(R)	U2J(U)/S2L(L)	T2H(T)	R2H(R)	S2H(S)	P2H(P)	U2J(U)/S2L(L)	T2H(T)	R2H(R)	S2H(S)	P2H(P)
Rated V	50(B)												
Capacitance -pF- (part numbering code) and thickness -mm-													
0.5(0R5)													
1(010)													
10(100)													
12(120)													
15(150)													
18(180)													
22(220)													
27(270)													
33(330)	0.5(5)	0.5(5)	0.5(5)										
39(390)													
47(470)							0.8(8)	0.8(8)					
56(560)													0.65(A)
68(680)													
82(820)													
100(101)													
120(121)													
150(151)													
180(181)													
220(221)													
270(271)													
330(331)													
390(391)													
470(471)													
560(561)													
680(681)													
820(821)													
1000(102)													
1200(122)													
1500(152)													

:X7R(B) :X5R(A) :Y5V(F) :C0G(C) :X6S(X)

Capacitance Table (General Capacitors)

Size	0402(05)					0603(10)				
	X7R(B) / X5R(A)									
Rated V	6.3(Q)	10(P)	16(O)	25(A)	50(B)	6.3(Q)	10(P)	16(O)	25(A)	50(B)
Capacitance -nF- (part numbering code) and thickness -mm-										
0.10(101)										
0.15(151)										
0.22(221)										
0.33(331)										
0.47(471)										
0.68(681)										
1.0(102)					0.5(5)					
1.5(152)										
2.2(222)										
3.3(332)										0.8(8)
4.7(472)										
6.8(682)										
10(103)										
15(153)										
22(223)					0.5(5)					
33(333)										
47(473)										
68(683)										
100(104)										
150(154)										
220(224)										
330(334)										
470(474)										
680(684)										
1000(105)										
1500(155)										
2200(225)										
3300(335)										
4700(475)										
10000(106)										
22000(226)										

:X7R(B) :X5R(A) :Y5V(F) :C0G(C) :X6S(X)

Part Numbering System

General Capacitors

Ultra High Capacitors

Super Small Capacitors

High Voltage Capacitors

Camera Strobe Circuit Capacitors

Array Type Capacitors

Low ESL Capacitors

Reliability Test Condition

Premium Capacitors for Automotive Applications

Packaging Specification

Application Manual for Surface Mounting

Capacitance Table (General Capacitors)

Size	0805(21)					
TC	X7R(B) / X5R(A)					
Rated V	4(R)	6.3(Q)	10(P)	16(O)	25(A)	50(B)
Capacitance -nF- (part numbering code) and thickness -mm-						
0.15(151)						
0.22(221)						
0.33(331)						
0.47(471)						
0.68(681)						
1.0(102)						
1.5(152)						
2.2(222)						0.65 (A)
3.3(332)						
4.7(472)						
6.8(682)						
10(103)						
15(153)						
22(223)						
33(333)						
47(473)					0.65 (A)	0.85 (C)
68(683)					0.65 (A)	0.85 (C)
100(104)				0.65 (A)	0.85 (C)	
150(154)				0.65 (A)	0.85 (C)	
220(224)			0.65 (A)			
330(334)			0.85 (C)	0.85 (C)		
390(394)			0.85 (C)		1.25 (F)	
470(474)			1.25 (F)	1.25 (F)	0.6 (6)	
680(684)			1.25 (F)	1.25 (F)	0.85 (C)	
1000(105)			1.25 (F)	1.25 (F)	0.85 (C)	
1500(155)			1.25 (F)	1.25 (F)	0.85 (C)	
2200(225)			1.25 (F)	1.25 (F)	0.85 (C)	
3300(335)		1.25 (F)				
4700(475)		1.25 (Q)				
6800(685)		0.85 (C)	0.85 (C)			
10000(106)	0.85 (C)	1.25 (Q)	0.85 (C)	1.25 (Y)	1.25 (Y)	1.25 (Y)
15000(156)	0.85 (C)	0.85 (C)				
22000(226)	1.25 (Y)					
47000(476)	1.25 (Y)	1.25 (Y)				

Legend: :X7R(B) :X5R(A) :Y5V(F) :C0G(C) :X6S(X)

Capacitance Table (General Capacitors)

Size	1206(31)					1210(32)				
TC	X7R(B) / X5R(A)									
Rated V	6.3(Q)	10(P)	16(O)	25(A)	50(B)	6.3(Q)	10(P)	16(O)	25(A)	50(B)
Capacitance -nF- (part numbering code) and thickness -mm-										
1.0(102)										
1.5(152)										
2.2(222)										
3.3(332)										
4.7(472)										
6.8(682)										
10(103)										
15(153)										
22(222)										
33(333)										
47(473)										
68(683)										
100(104)										
150(154)					0.85 (C)					
220(224)				0.85 (C)	1.25 (F)					
330(334)				0.85 (C)	1.25 (F)					
470(474)			0.85 (C)	1.25 (F)	1.6 (H)					1.25 (F)
680(684)			0.85 (C)	1.25 (F)	1.6 (H)					1.6 (H)
1000(105)		0.85 (C)	1.25 (F)	1.6 (H)	1.6 (H)				1.25 (F)	1.6 (H)
1500(155)		1.25 (F)	1.6 (H)	1.6 (H)	1.6 (H)				2.0 (I)	2.0 (I)
2200(225)		1.25 (F)	1.6 (H)	1.6 (H)	1.6 (H)			1.25 (F)	2.0 (I)	2.5 (J)
3300(335)		1.6 (H)	1.6 (H)	1.6 (H)	1.6 (H)			1.6 (H)	2.5 (J)	1.8 (Y)
4700(475)		1.6 (H)	1.6 (H)	1.6 (H)	1.6 (H)			2.0 (I)	2.5 (J)	1.8 (Y)
6800(685)	1.6 (H)	0.85 (C)	0.85 (C)	0.85 (C)	0.85 (C)		2.0 (I)	2.5 (J)	0.85 (C)	0.9 (9)
10000(106)	1.6 (H)	0.85 (C)	0.85 (C)	0.85 (C)	0.85 (C)		2.5 (J)	2.5 (J)	2.5 (J)	2.5 (J)
22000(226)		0.85 (C)	0.85 (C)	0.85 (C)	0.85 (C)		2.5 (J)	2.5 (J)	2.5 (J)	2.5 (J)
33000(336)							2.5 (J)			
47000(476)	1.6 (H)						2.5 (J)			
68000(686)							2.5 (V)			
100000(107)										

Legend: :X7R(B) :X5R(A) :Y5V(F) :C0G(C) :X6S(X)

Part Numbering System

General Capacitors

Ultra High Capacitors

Super Small Capacitors

High Voltage Capacitors

Camera Strobe Circuit Capacitors

Array Type Capacitors

Low ESL Capacitors

Reliability Test Condition

Premium Capacitors for Automotive Applications

Packaging Specification

Application Manual for Surface Mounting

Capacitance Table (General Capacitors)

Size	1812(43)					2220(55)		
	X7R(B) / X5R(A)							
TC	Y5V(F)							
Rated V	6.3(Q)	10(P)	16(O)	25(A)	50(B)	6.3(Q)	10(P)	25(A)
Capacitance -nF- (part numbering code) and thickness -mm-								
10(103)					1.25 (F)			
1000(105)								
1500(155)								
2200(225)								
3300(335)								
4700(475)				2.5 (J)				
6800(685)								2.5 (J)
10000(106)				3.2 (L)				
15000(156)								
22000(226)		2.5 (J)						
33000(336)							2.5 (J)	
47000(476)	2.5 (J)							
100000(107)	3.2 (L)					2.5 (J)		

Size	0402(05)					0603(10)			
	Y5V(F)								
TC	Y5V(F)								
Rated V	6.3(Q)	10(P)	16(O)	25(A)	50(B)	6.3(Q)	10(P)	16(O)	50(B)
Capacitance -nF- (part numbering code) and thickness -mm-									
2.2(222)					0.50 (5)				
4.7(472)									
10(103)									
15(153)									
22(223)				0.50 (5)					
47(473)			0.50 (5)						0.80 (8)
100(104)			0.50 (5)						
220(224)									
470(474)		0.50 (5)							
1000(105)	0.50 (5)							0.80 (8)	
2200(225)							0.80 (8)		
4700(475)						0.80 (8)			

Legend: :X7R(B) :X5R(A) :Y5V(F) :COG(C) :X6S(X)

Capacitance Table (General Capacitors)

Size	0805(21)				1206(31)			
	Y5V(F)							
TC	Y5V(F)							
Rated V	10(P)	16(O)	25(A)	50(B)	10(P)	16(O)	25(A)	50(B)
Capacitance -nF- (part numbering code) and thickness -mm-								
2.2(222)				0.65 (A)				
4.7(472)								
10(103)								
22(223)								
47(473)								
100(104)								
220(224)			0.65 (A)					0.85 (C)
470(474)		0.65 (A)	0.85 (C)	1.25 (F)				
1000(105)		0.85 (C)	0.85 (C)				0.85 (C)	1.25 (F)
2200(225)		1.25 (F)	1.25 (F)			0.85 (C)	1.25 (F)	
4700(475)						1.25 (F)		
10000(106)	1.25 (F)					1.6 (H)		
22000(226)					1.6 (H)			

Size	1210(32)			1812(43)		2220(55)
	Y5V(F)					
TC	Y5V(F)					
Rated V	10(P)	25(A)	35(L)	16(O)	50(B)	10(P)
Capacitance -nF- (part numbering code) and thickness -mm-						
10(103)						
22(223)						
47(473)						
100(104)						
220(224)						
470(474)						
1000(105)						
2200(225)						
4700(475)		1.6 (H)	1.6 (H)			
10000(106)					2.5 (J)	
22000(226)	2.5 (J)			2.0 (I)		
47000(476)						
100000(107)						2.5 (J)

Legend: :X7R(B) :X5R(A) :Y5V(F) :COG(C) :X6S(X)

Part Numbering System

General Capacitors

Ultra High Capacitors

Super Small Capacitors

High Voltage Capacitors

Camera Strobe Circuit Capacitors

Array Type Capacitors

Low ESL Capacitors

Reliability Test Condition

Premium Capacitors for Automotive Applications

Packaging Specification

Application Manual for Surface Mounting

Product Line Up (General Capacitors)

Part Number	Size L × W (1.0 × 0.5mm)							Capacitance (pF)	Capacitance Tolerance	Rated Voltage (Vdc)	Thickness Max. (mm)
	C	P	R	S	T	U	L				
	COG	P2H	R2H	S2H	T2H	U2J	S2L				
CL05○0R2CB5ANN □	●				●	●		0.20	±0.25pF	50	0.55
CL05○0R5CB5ANN □	●				●	●		0.50	±0.25pF	50	0.55
CL05○0R8CB5ANN □	●				●	●		0.80	±0.25pF	50	0.55
CL05○0R82CB5ANN □	●				●	●		0.82	±0.25pF	50	0.55
CL05○0R9CB5ANN □	●				●	●		0.90	±0.25pF	50	0.55
CL05○010CB5ANN □	●				●	●		1.00	±0.25pF	50	0.55
CL05○01R2CB5ANN □	●				●	●		1.20	±0.25pF	50	0.55
CL05○01R5CB5ANN □	●				●	●		1.50	±0.25pF	50	0.55
CL05○01R8CB5ANN □	●				●	●		1.80	±0.25pF	50	0.55
CL05○020CB5ANN □	●				●	●		2.00	±0.25pF	50	0.55
CL05○02R2CB5ANN □	●				●	●		2.20	±0.25pF	50	0.55
CL05○02R7CB5ANN □	●				●	●		2.70	±0.25pF	50	0.55
CL05○030CB5ANN □	●				●	●		3.00	±0.25pF	50	0.55
CL05○03R3CB5ANN □	●				●	●		3.30	±0.25pF	50	0.55
CL05○03R9CB5ANN □	●				●	●		3.90	±0.25pF	50	0.55
CL05○040CB5ANN □	●				●	●		4.00	±0.25pF	50	0.55
CL05○04R7CB5ANN □	●				●	●		4.70	±0.25pF	50	0.55
CL05○050DB5ANN □	●				●	●		5.00	±0.5pF	50	0.55
CL05○05R6DB5ANN □	●				●	●		5.60	±0.5pF	50	0.55
CL05○060DB5ANN □	●				●	●		6.00	±0.5pF	50	0.55
CL05○06R8DB5ANN □	●				●	●		6.80	±0.5pF	50	0.55
CL05○070DB5ANN □	●				●	●		7.00	±0.5pF	50	0.55
CL05○080DB5ANN □	●				●	●		8.00	±0.5pF	50	0.55
CL05○08R2DB5ANN □	●				●	●		8.20	±0.5pF	50	0.55
CL05○090DB5ANN □	●				●	●		9.00	±0.5pF	50	0.55
CL05○100JB5NNN □	●							10	±5%	50	0.55
CL05○120JB5NNN □	●							12	±5%	50	0.55
CL05○120JB5ANN □					●	●		12	±5%	50	0.55
CL05○150JB5NNN □	●							15	±5%	50	0.55
CL05○180JB5NNN □	●							18	±5%	50	0.55
CL05○220JB5NNN □	●							22	±5%	50	0.55
CL05○270JB5NNN □	●							27	±5%	50	0.55
CL05○270JB5ANN □					●	●		27	±5%	50	0.55
CL05○330JB5NNN □	●							33	±5%	50	0.55
CL05○330JB5ANN □					●	●		33	±5%	50	0.55

※ ○ mark means temperature characteristic code. The parts with mark ● are available to produce.
 ※ □ mark means packaging code. If you want to learn the code or quantity in detail, please see p 81.

Product Line Up (General Capacitors)

Part Number	Size L × W (1.0 × 0.5mm)							Capacitance (pF)	Capacitance Tolerance	Rated Voltage (Vdc)	Thickness Max. (mm)
	C	P	R	S	T	U	L				
	COG	P2H	R2H	S2H	T2H	U2J	S2L				
CL05○390JB5NNN □	●							39	±5%	50	0.55
CL05○390JB5ANN □					●	●		39	±5%	50	0.55
CL05○470JB5NNN □	●							47	±5%	50	0.55
CL05○470JB5ANN □					●	●		47	±5%	50	0.55
CL05○560JB5NNN □	●							56	±5%	50	0.55
CL05○560JB5ANN □					●	●		56	±5%	50	0.55
CL05○680JB5NNN □	●							68	±5%	50	0.55
CL05○680JB5ANN □					●	●		68	±5%	50	0.55
CL05○820JB5NNN □	●							82	±5%	50	0.55
CL05○820JB5ANN □						●		82	±5%	50	0.55
CL05○101JB5NNN □	●							100	±5%	50	0.55
CL05○101JB5ANN □						●		100	±5%	50	0.55
CL05○121JB5NNN □	●							120	±5%	50	0.55
CL05○151JB5NNN □	●							150	±5%	50	0.55
CL05○151JB5ANN □						●		150	±5%	50	0.55
CL05○181JB5NNN □	●							180	±5%	50	0.55
CL05○221JB5NNN □	●							220	±5%	50	0.55
CL05○271JB5NNN □	●							270	±5%	50	0.55
CL05○331JB5NNN □	●							330	±5%	50	0.55
CL05○471JB5NNN □	●							470	±5%	50	0.55

Part Number	Size L × W (1.6 × 0.8mm)							Capacitance (pF)	Capacitance Tolerance	Rated Voltage (Vdc)	Thickness Max. (mm)
	C	P	R	S	T	U	L				
	COG	P2H	R2H	S2H	T2H	U2J	S2L				
CL10○0R2CB8ANN □	●		●	●	●	●	●	0.20	±0.25pF	50	0.90
CL10○0R3CB8ANN □	●		●	●	●	●	●	0.30	±0.25pF	50	0.90
CL10○0R4CB8ANN □	●		●	●	●	●	●	0.40	±0.25pF	50	0.90
CL10○0R47CB8ANN □	●		●	●	●	●	●	0.47	±0.25pF	50	0.90
CL10○0R5CB8ANN □	●		●	●	●	●	●	0.50	±0.25pF	50	0.90
CL10○0R56CB8ANN □	●		●	●	●	●	●	0.56	±0.25pF	50	0.90
CL10○0R68CB8ANN □	●		●	●	●	●	●	0.68	±0.25pF	50	0.90
CL10○0R7CB8ANN □	●		●	●	●	●	●	0.70	±0.25pF	50	0.90
CL10○0R8CB8ANN □	●		●	●	●	●	●	0.80	±0.25pF	50	0.90

※ ○ mark means temperature characteristic code. The parts with mark ● are available to produce.
 ※ □ mark means packaging code. If you want to learn the code or quantity in detail, please see p 81.

Part Numbering System

General Capacitors

Ultra High Capacitors

Super Small Capacitors

High Voltage Capacitors

Camera Strobe Circuit Capacitors

Array Type Capacitors

Low ESL Capacitors

Reliability Test Condition

Premium Capacitors for Automotive Applications

Packaging Specification

Application Manual for Surface Mounting

Product Line Up (General Capacitors)

Part Number	Size L×W (1.6×0.8mm)							Capacitance (pF)	Capacitance Tolerance	Rated Voltage (Vdc)	Thickness Max. (mm)
	C	P	R	S	T	U	L				
	COG	P2H	R2H	S2H	T2H	U2J	S2L				
CL10○R82CB8ANN □	●		●	●	●	●	●	0.82	±0.25pF	50	0.90
CL10○010CB8ANN □	●		●	●	●	●	●	1.00	±0.25pF	50	0.90
CL10○1R2CB8ANN □	●		●	●	●	●	●	1.20	±0.25pF	50	0.90
CL10○1R5CB8ANN □	●		●	●	●	●	●	1.50	±0.25pF	50	0.90
CL10○1R8CB8ANN □	●		●	●	●	●	●	1.80	±0.25pF	50	0.90
CL10○020CB8ANN □	●		●	●	●	●	●	2.00	±0.25pF	50	0.90
CL10○2R2CB8ANN □	●		●	●	●	●	●	2.20	±0.25pF	50	0.90
CL10○2R7CB8ANN □	●		●	●	●	●	●	2.70	±0.25pF	50	0.90
CL10○030CB8ANN □	●		●	●	●	●	●	3.00	±0.25pF	50	0.90
CL10○3R3CB8ANN □	●		●	●	●	●	●	3.30	±0.25pF	50	0.90
CL10○3R9CB8ANN □	●		●	●	●	●	●	3.90	±0.25pF	50	0.90
CL10○040CB8ANN □	●		●	●	●	●	●	4.00	±0.25pF	50	0.90
CL10○4R7CB8ANN □	●		●	●	●	●	●	4.70	±0.25pF	50	0.90
CL10○050DB8ANN □	●		●	●	●	●	●	5.00	±0.5pF	50	0.90
CL10○5R6DB8ANN □	●		●	●	●	●	●	5.60	±0.5pF	50	0.90
CL10○060DB8ANN □	●		●	●	●	●	●	6.00	±0.5pF	50	0.90
CL10○6R8DB8ANN □	●		●	●	●	●	●	6.80	±0.5pF	50	0.90
CL10○070DB8ANN □	●		●	●	●	●	●	7.00	±0.5pF	50	0.90
CL10○080DB8ANN □	●		●	●	●	●	●	8.00	±0.5pF	50	0.90
CL10○8R2DB8ANN □	●		●	●	●	●	●	8.20	±0.5pF	50	0.90
CL10○090DB8ANN □	●		●	●	●	●	●	9.00	±0.5pF	50	0.90
CL10○100JB8NNN □	●							10	±5%	50	0.90
CL10○100JB8ANN □			●	●	●	●	●	10	±5%	50	0.90
CL10○120JB8NNN □	●							12	±5%	50	0.90
CL10○120JB8ANN □			●	●	●	●	●	12	±5%	50	0.90
CL10○150JB8NNN □	●							15	±5%	50	0.90
CL10○150JB8ANN □			●	●	●	●	●	15	±5%	50	0.90
CL10○180JB8NNN □	●							18	±5%	50	0.90
CL10○180JB8ANN □			●	●	●	●	●	18	±5%	50	0.90
CL10○220JB8NNN □	●							22	±5%	50	0.90
CL10○220JB8ANN □			●	●	●	●	●	22	±5%	50	0.90
CL10○270JB8NNN □	●							27	±5%	50	0.90
CL10○270JB8ANN □			●		●	●	●	27	±5%	50	0.90
CL10○330JB8NNN □	●							33	±5%	50	0.90
CL10○330JB8ANN □			●		●	●	●	33	±5%	50	0.90

※ ○ mark means temperature characteristic code. The parts with mark ● are available to produce.
 ※ □ mark means packaging code. If you want to learn the code or quantity in detail, please see p 81.

Product Line Up (General Capacitors)

Part Number	Size L×W (1.6×0.8mm)							Capacitance (pF)	Capacitance Tolerance	Rated Voltage (Vdc)	Thickness Max. (mm)
	C	P	R	S	T	U	L				
	COG	P2H	R2H	S2H	T2H	U2J	S2L				
CL10○390JB8NNN □	●							39	±5%	50	0.90
CL10○390JB8ANN □			●		●	●	●	39	±5%	50	0.90
CL10○470JB8NNN □	●							47	±5%	50	0.90
CL10○470JB8ANN □			●		●	●	●	47	±5%	50	0.90
CL10○560JB8NNN □	●							56	±5%	50	0.90
CL10○560JB8ANN □			●		●	●		56	±5%	50	0.90
CL10○680JB8NNN □	●							68	±5%	50	0.90
CL10○680JB8ANN □			●		●	●		68	±5%	50	0.90
CL10○820JB8NNN □	●							82	±5%	50	0.90
CL10○820JB8ANN □			●		●	●		82	±5%	50	0.90
CL10○101JB8NNN □	●							100	±5%	50	0.90
CL10○101JB8ANN □			●		●	●		100	±5%	50	0.90
CL10○121JB8NNN □	●							120	±5%	50	0.90
CL10○121JB8ANN □			●		●	●		120	±5%	50	0.90
CL10○151JB8NNN □	●							150	±5%	50	0.90
CL10○151JB8ANN □			●		●	●		150	±5%	50	0.90
CL10○181JB8NNN □	●							180	±5%	50	0.90
CL10○181JB8ANN □			●		●	●		180	±5%	50	0.90
CL10○221JB8NNN □	●							220	±5%	50	0.90
CL10○221JB8ANN □					●	●		220	±5%	50	0.90
CL10○271JB8NNN □	●							270	±5%	50	0.90
CL10○271JB8ANN □					●	●		270	±5%	50	0.90
CL10○331JB8NNN □	●							330	±5%	50	0.90
CL10○331JB8ANN □					●	●		330	±5%	50	0.90
CL10○391JB8NNN □	●							390	±5%	50	0.90
CL10○471JB8NNN □	●							470	±5%	50	0.90
CL10○471JB8ANN □						●		470	±5%	50	0.90
CL10○561JB8NNN □	●							560	±5%	50	0.90
CL10○681JB8NNN □	●							680	±5%	50	0.90
CL10○681JB8ANN □						●		680	±5%	50	0.90
CL10○821JB8NNN □	●							820	±5%	50	0.90
CL10○102JB8NNN □	●							1000	±5%	50	0.90
CL10○122JB8NNN □	●							1200	±5%	50	0.90
CL10○222JB8NNN □	●							2200	±5%	50	0.90
CL10○332JA8NNN □	●							3300	±5%	25	0.90

※ ○ mark means temperature characteristic code. The parts with mark ● are available to produce.
 ※ □ mark means packaging code. If you want to learn the code or quantity in detail, please see p 81.

- Part Numbering System
- General Capacitors
- Ultra High Capacitors
- Super Small Capacitors
- High Voltage Capacitors
- Camera Strobe Circuit Capacitors
- Array Type Capacitors
- Low ESL Capacitors
- Reliability Test Condition
- Premium Capacitors for Automotive Applications
- Packaging Specification
- Application Manual for Surface Mounting

Product Line Up (General Capacitors)

Part Number	Size L×W (2.0×1.25mm)							Capacitance (pF)	Capacitance Tolerance	Rated Voltage (Vdc)	Thickness Max. (mm)
	C	P	R	S	T	U	L				
	COG	P2H	R2H	S2H	T2H	U2J	S2L				
CL21○R47CBAANN □	●	●	●	●	●	●	●	0.47	±0.25pF	50	0.75
CL21○0R5CBAANN □	●	●	●	●	●	●	●	0.50	±0.25pF	50	0.75
CL21○R68CBAANN □	●	●	●	●	●	●	●	0.68	±0.25pF	50	0.75
CL21○R82CBAANN □	●	●	●	●	●	●	●	0.82	±0.25pF	50	0.75
CL21○010CBAANN □	●	●	●	●	●	●	●	1.00	±0.25pF	50	0.75
CL21○1R2CBAANN □	●	●	●	●	●	●	●	1.20	±0.25pF	50	0.75
CL21○1R5CBAANN □	●	●	●	●	●	●	●	1.50	±0.25pF	50	0.75
CL21○1R8CBAANN □	●	●	●	●	●	●	●	1.80	±0.25pF	50	0.75
CL21○020CBAANN □	●	●	●	●	●	●	●	2.00	±0.25pF	50	0.75
CL21○2R2CBAANN □	●	●	●	●	●	●	●	2.20	±0.25pF	50	0.75
CL21○2R7CBAANN □	●	●	●	●	●	●	●	2.70	±0.25pF	50	0.75
CL21○030CBAANN □	●	●	●	●	●	●	●	3.00	±0.25pF	50	0.75
CL21○3R3CBAANN □	●	●	●	●	●	●	●	3.30	±0.25pF	50	0.75
CL21○3R9CBAANN □	●	●	●	●	●	●	●	3.90	±0.25pF	50	0.75
CL21○040CBAANN □	●	●	●	●	●	●	●	4.00	±0.25pF	50	0.75
CL21○4R7CBAANN □	●	●	●	●	●	●	●	4.70	±0.25pF	50	0.75
CL21○050DBAANN □	●	●	●	●	●	●	●	5.00	±0.5pF	50	0.75
CL21○5R6DBAANN □	●	●	●	●	●	●	●	5.60	±0.5pF	50	0.75
CL21○060DBAANN □	●	●	●	●	●	●	●	6.00	±0.5pF	50	0.75
CL21○6R8DBAANN □	●	●	●	●	●	●	●	6.80	±0.5pF	50	0.75
CL21○070DBAANN □	●	●	●	●	●	●	●	7.00	±0.5pF	50	0.75
CL21○080DBAANN □	●	●	●	●	●	●	●	8.00	±0.5pF	50	0.75
CL21○8R2DBAANN □	●	●	●	●	●	●	●	8.20	±0.5pF	50	0.75
CL21○090DBAANN □	●	●	●	●	●	●	●	9.00	±0.5pF	50	0.75
CL21○100JBANN □	●							10	±5%	50	0.75
CL21○100JBAANN □			●	●	●	●	●	10	±5%	50	0.75
CL21○120JBANN □	●							12	±5%	50	0.75
CL21○120JBAANN □			●	●	●	●	●	12	±5%	50	0.75
CL21○150JBANN □	●							15	±5%	50	0.75
CL21○180JBANN □	●							18	±5%	50	0.75
CL21○220JBANN □	●							22	±5%	50	0.75
CL21○270JBANN □	●							27	±5%	50	0.75
CL21○330JBANN □	●							33	±5%	50	0.75
CL21○390JBANN □	●							39	±5%	50	0.75
CL21○470JBANN □	●							47	±5%	50	0.75

※ ○ mark means temperature characteristic code. The parts with mark ● are available to produce.
 ※ □ mark means packaging code. If you want to learn the code or quantity in detail, please see p 81.

Product Line Up (General Capacitors)

Part Number	Size L×W (2.0×1.25mm)							Capacitance (pF)	Capacitance Tolerance	Rated Voltage (Vdc)	Thickness Max. (mm)
	C	P	R	S	T	U	L				
	COG	P2H	R2H	S2H	T2H	U2J	S2L				
CL21○560JBANN □	●							56	±5%	50	0.75
CL21○680JBANN □	●							68	±5%	50	0.75
CL21○820JBANN □	●							82	±5%	50	0.75
CL21○101JBANN □	●							100	±5%	50	0.75
CL21○101JBAANN □			●	●	●	●	●	100	±5%	50	0.75
CL21○121JBANN □	●							120	±5%	50	0.75
CL21○151JBANN □	●							150	±5%	50	0.75
CL21○181JBANN □	●							180	±5%	50	0.75
CL21○221JBANN □	●							220	±5%	50	0.75
CL21○271JBANN □	●							270	±5%	50	0.75
CL21○331JBANN □	●							330	±5%	50	0.75
CL21○331JBAANN □			●	●	●	●	●	330	±5%	50	0.75
CL21○391JBANN □	●							390	±5%	50	0.75
CL21○471JBANN □	●							470	±5%	50	0.75
CL21○471JBAANN □			●	●	●	●	●	470	±5%	50	0.75
CL21○561JBANN □	●							560	±5%	50	0.75
CL21○821JBCNN □	●							820	±5%	50	0.95
CL21○821JBAANN □			●	●	●	●	●	820	±5%	50	0.75
CL21○102JBCNN □	●							1000	±5%	50	0.95
CL21○122JBFNN □	●							1200	±5%	50	1.35
CL21○152JBFNN □	●							1500	±5%	50	1.35
CL21○182JBFNN □	●							1800	±5%	50	1.35
CL21○222JBFNN □	●							2200	±5%	50	1.35
CL21○332JAFNN □	●							3300	±5%	25	1.35
CL21○332JBFNN □	●							3300	±5%	50	1.35
CL21○392JBFNN □	●							3900	±5%	50	1.35
CL21○472JAFNN □	●							4700	±5%	25	1.35
CL21○472JBFNN □	●							4700	±5%	50	1.35
CL21○562JBFNN □	●							5600	±5%	50	1.35
CL21○103JBFNN □	●							10000	±5%	50	1.35

※ ○ mark means temperature characteristic code. The parts with mark ● are available to produce.
 ※ □ mark means packaging code. If you want to learn the code or quantity in detail, please see p 81.

Part Numbering System

General Capacitors

Ultra High Capacitors

Super Small Capacitors

High Voltage Capacitors

Camera Strobe Circuit Capacitors

Array Type Capacitors

Low ESL Capacitors

Reliability Test Condition

Premium Capacitors for Automotive Applications

Packaging Specification

Application Manual for Surface Mounting

Product Line Up (General Capacitors)

Part Number	Size L×W (3.2×1.6(2.5)mm)							Capacitance (pF)	Capacitance Tolerance	Rated Voltage (Vdc)	Thickness Max. (mm)
	C	P	R	S	T	U	L				
	COG	P2H	R2H	S2H	T2H	U2J	S2L				
CL31○122JBCNNN □	●							1200	±5%	50	0.75
CL31○152JBCNNN □	●							1500	±5%	50	0.75
CL31○182JBCNNN □	●							1800	±5%	50	0.75
CL31○222JBCNNN □	●							2200	±5%	50	0.75
CL31○472JBFNNN □	●							4700	±5%	50	1.35
CL31○562JBHNNN □	●							5600	±5%	50	1.80
CL31○682JBHNNN □	●							6800	±5%	50	1.80
CL31○103JAFNNN □	●							10000	±5%	25	1.35
CL32○103JBFNNN □	●							10000	±5%	50	1.35

Part Number	Size L×W (1.0×0.5mm)			Capacitance	Capacitance Tolerance	Rated Voltage (Vdc)	Thickness Max. (mm)
	A	B	F				
	X5R(EIA)	X7R(EIA)	Y5V(EIA)				
CL05○221KB5NNN □		●		0.22nF	±10%	50	0.55
CL05○331KB5NNN □		●		0.33nF	±10%	50	0.55
CL05○471KB5NNN □		●		0.47nF	±10%	50	0.55
CL05○681KB5NNN □		●		0.68nF	±10%	50	0.55
CL05○102KB5NNN □		●		1.0nF	±10%	50	0.55
CL05○152KB5NNN □		●		1.5nF	±10%	50	0.55
CL05○222KB5NNN □		●		2.2nF	±10%	50	0.55
CL05○332KB5NNN □		●		3.3nF	±10%	50	0.55
CL05○472KB5NNN □		●		4.7nF	±10%	50	0.55
CL05○682KB5NNN □		●		6.8nF	±10%	50	0.55
CL05○103KB5NNN □		●		10nF	±10%	50	0.55
CL05○103ZB5NNN □			●	10nF	+80%~-20%	50	0.55
CL05○153ZB5NNN □			●	15nF	+80%~-20%	50	0.55
CL05○102KA5NNN □		●		1nF	±10%	25	0.55
CL05○222KA5NNN □		●		2.2nF	±10%	25	0.55
CL05○332KA5NNN □		●		3.3nF	±10%	25	0.55
CL05○472KA5NNN □		●		4.7nF	±10%	25	0.55
CL05○682KA5NNN □		●		6.8nF	±10%	25	0.55
CL05○103KA5NNN □		●		10nF	±10%	25	0.55

※ ○ mark means temperature characteristic code. The parts with mark ● are available to produce.
 ※ □ mark means packaging code. If you want to learn the code or quantity in detail, please see p 81.

Product Line Up (General Capacitors)

Part Number	Size L×W (1.0×0.5mm)			Capacitance	Capacitance Tolerance	Rated Voltage (Vdc)	Thickness Max. (mm)
	A	B	F				
	X5R(EIA)	X7R(EIA)	Y5V(EIA)				
CL05○153KA5NNN □		●		15nF	±10%	25	0.55
CL05○223KA5NNN □		●		22nF	±10%	25	0.55
CL05○223ZA5NNN □			●	22nF	+80%~-20%	25	0.55
CL05○333ZA5NNN □			●	33nF	+80%~-20%	25	0.55
CL05○104KA5NNN □	●			100nF	±10%	25	0.55
CL05○102KO5NNN □		●		1.0nF	±10%	16	0.55
CL05○472KO5NNN □		●		4.7nF	±10%	16	0.55
CL05○682KO5NNN □		●	●	6.8nF	±10%	16	0.55
CL05○103KO5NNN □		●		10nF	±10%	16	0.55
CL05○103ZO5NNN □			●	10nF	+80%~-20%	16	0.55
CL05○153KO5NNN □		●		15nF	±10%	16	0.55
CL05○223KO5NNN □		●		22nF	±10%	16	0.55
CL05○223ZO5NNN □			●	22nF	+80%~-20%	16	0.55
CL05○333KO5NNN □		●		33nF	±10%	16	0.55
CL05○473KO5NNN □		●		47nF	±10%	16	0.55
CL05○473ZO5NNN □			●	47nF	+80%~-20%	16	0.55
CL05○683KO5NNN □		●		68nF	±10%	16	0.55
CL05○104KO5NNN □	●	●		100nF	±10%	16	0.55
CL05○104ZO5NNN □			●	100nF	+80%~-20%	16	0.55
CL05○224ZO5NNN □			●	220nF	+80%~-20%	16	0.55
CL05○103KP5NNN □		●		10nF	±10%	10	0.55
CL05○333KP5NNN □		●		33nF	±10%	10	0.55
CL05○473KP5NNN □	●	●		47nF	±10%	10	0.55
CL05○683KP5NNN □		●		68nF	±10%	10	0.55
CL05○104KP5NNN □	●	●		100nF	±10%	10	0.55
CL05○224ZP5NNN □			●	220nF	+80%~-20%	10	0.55
CL05○474ZP5NNN □			●	470nF	+80%~-20%	10	0.55
CL05○104KQ5NNN □	●	●		100nF	±10%	6.3	0.55
CL05○154KQ5NNN □	●			150nF	±10%	6.3	0.55
CL05○474KQ5NNN □			●	470nF	+80%~-20%	6.3	0.55

※ ○ mark means temperature characteristic code. The parts with mark ● are available to produce.
 ※ □ mark means packaging code. If you want to learn the code or quantity in detail, please see p 81.

Part Numbering System

General Capacitors

Ultra High Capacitors

Super Small Capacitors

High Voltage Capacitors

Camera Strobe Circuit Capacitors

Array Type Capacitors

Low ESL Capacitors

Reliability Test Condition

Premium Capacitors for Automotive Applications

Packaging Specification

Application Manual for Surface Mounting

Product Line Up (General Capacitors)

Part Number	Size L×W (1.6×0.8mm)			Capacitance	Capacitance Tolerance	Rated Voltage (Vdc)	Thickness Max. (mm)
	A	B	F				
	X5R(EIA)	X7R(EIA)	Y5V(EIA)				
CL10○101KB8NNN □		●		0.10nF	±10%	50	0.90
CL10○151KB8NNN □		●		0.15nF	±10%	50	0.90
CL10○221KB8NNN □		●		0.22nF	±10%	50	0.90
CL10○331KB8NNN □		●		0.33nF	±10%	50	0.90
CL10○471KB8NNN □		●		0.47nF	±10%	50	0.90
CL10○681KB8NNN □		●		0.68nF	±10%	50	0.90
CL10○102KB8NNN □		●		1.0nF	±10%	50	0.90
CL10○152KB8NNN □		●		1.5nF	±10%	50	0.90
CL10○222KB8NNN □		●		2.2nF	±10%	50	0.90
CL10○332KB8NNN □		●		3.3nF	±10%	50	0.90
CL10○472KB8NNN □		●		4.7nF	±10%	50	0.90
CL10○682KB8NNN □		●		6.8nF	±10%	50	0.90
CL10○103KB8NNN □		●		10nF	±10%	50	0.90
CL10○103ZB8NNN □			●	10nF	+80%~-20%	50	0.90
CL10○153KB8NNN □		●		15nF	±10%	50	0.90
CL10○223KB8NNN □		●		22nF	±10%	50	0.90
CL10○223ZB8NNN □			●	22nF	+80%~-20%	50	0.90
CL10○333KB8NNN □		●		33nF	±10%	50	0.90
CL10○473KB8NNN □		●		47nF	±10%	50	0.90
CL10○473ZB8NNN □			●	47nF	+80%~-20%	50	0.90
CL10○683KB8NNN □		●		68nF	±10%	50	0.90
CL10○104KB8NNN □		●		100nF	±10%	50	0.90
CL10○104ZB8NNN □			●	100nF	+80%~-20%	50	0.90
CL10○224ZB8NNN □			●	220nF	+80%~-20%	50	0.90
CL10○474ZB8NNN □			●	470nF	+80%~-20%	50	0.90
CL10○102KA8NNN □		●		1.0nF	±10%	25	0.90
CL10○472KA8NNN □		●		4.7nF	±10%	25	0.90
CL10○682KA8NNN □		●		6.8nF	±10%	25	0.90
CL10○103KA8NNN □		●		10nF	±10%	25	0.90
CL10○153KA8NNN □		●		15nF	±10%	25	0.90
CL10○223KA8NNN □		●		22nF	±10%	25	0.90
CL10○223ZA8NNN □			●	22nF	+80%~-20%	25	0.90
CL10○333KA8NNN □		●		33nF	±10%	25	0.90
CL10○473KA8NNN □		●		47nF	±10%	25	0.90
CL10○473ZA8NNN □			●	47nF	+80%~-20%	25	0.90

※ ○ mark means temperature characteristic code. The parts with mark ● are available to produce.
 ※ □ mark means packaging code. If you want to learn the code or quantity in detail, please see p 81.

Product Line Up (General Capacitors)

Part Number	Size L×W (1.6×0.8mm)			Capacitance	Capacitance Tolerance	Rated Voltage (Vdc)	Thickness Max. (mm)
	A	B	F				
	X5R(EIA)	X7R(EIA)	Y5V(EIA)				
CL10○683KA8NNN □		●		68nF	±10%	25	0.90
CL10○104KA8NNN □		●		100nF	±10%	25	0.90
CL10○104ZA8NNN □			●	100nF	+80%~-20%	25	0.90
CL10○224KA8NNN □	●			220nF	±10%	25	0.90
CL10○224ZA8NNN □			●	220nF	+80%~-20%	25	0.90
CL10○334KA8NNN □	●			330nF	±10%	25	0.90
CL10○474ZA8NNN □			●	470nF	+80%~-20%	25	0.90
CL10○105KA8NNN □		●		1.0nF	±10%	25	0.90
CL10○102KO8NNN □		●		1.0nF	±10%	16	0.90
CL10○103KO8NNN □		●		10nF	±10%	16	0.90
CL10○153KO8NNN □		●		15nF	±10%	16	0.90
CL10○223KO8NNN □		●		22nF	±10%	16	0.90
CL10○333KO8NNN □		●		33nF	±10%	16	0.90
CL10○473KO8NNN □		●	●	47nF	±10%	16	0.90
CL10○473ZO8NNN □				47nF	+80%~-20%	16	0.90
CL10○683KO8NNN □		●		68nF	±10%	16	0.90
CL10○104KO8NNN □		●	●	100nF	±10%	16	0.90
CL10○104ZO8NNN □				100nF	+80%~-20%	16	0.90
CL10○154KO8NNN □		●		150nF	±10%	16	0.90
CL10○224KO8NNN □		●		220nF	±10%	16	0.90
CL10○224ZO8NNN □			●	220nF	+80%~-20%	16	0.90
CL10○334KO8NNN □		●		330nF	±10%	16	0.90
CL10○474KO8NNN □		●		470nF	±10%	16	0.90
CL10○474ZO8NNN □			●	470nF	+80%~-20%	16	0.90
CL10○105KO8NNN □		●		1.0μF	±10%	16	0.90
CL10○105ZO8NNN □			●	1.0μF	+80%~-20%	16	0.90
CL10○154KP8NNN □		●		150nF	±10%	10	0.90
CL10○224KP8NNN □	●	●		220nF	±10%	10	0.90
CL10○334KP8NNN □		●		330nF	±10%	10	0.90
CL10○474KP8NNN □		●		470nF	±10%	10	0.90
CL10○474ZP8NNN □			●	470nF	+80%~-20%	10	0.90
CL10○105ZP8NNN □			●	1.0μF	+80%~-20%	10	0.90
CL10○474KQ8NNN □		●		470nF	±10%	6.3	0.90
CL10○684KQ8NNN □		●		680	±10%	6.3	0.90
CL10○105KQ8NNN □		●		1.0μF	±10%	6.3	0.90
CL10○225KQ8NNN □		●		2.2μF	±10%	6.3	0.90

※ ○ mark means temperature characteristic code. The parts with mark ● are available to produce.
 ※ □ mark means packaging code. If you want to learn the code or quantity in detail, please see p 81.

Part Numbering System

General Capacitors

Ultra High Capacitors

Super Small Capacitors

High Voltage Capacitors

Camera Strobe Circuit Capacitors

Array Type Capacitors

Low ESL Capacitors

Reliability Test Condition

Premium Capacitors for Automotive Applications

Packaging Specification

Application Manual for Surface Mounting

Product Line Up (General Capacitors)

Part Number	Size L×W (2.0×1.25mm)			Capacitance	Capacitance Tolerance	Rated Voltage (Vdc)	Thickness Max. (mm)
	A	B	F				
	X5R(EIA)	X7R(EIA)	Y5V(EIA)				
CL21○151KBANNN □		●		0.15nF	±10%	50	0.75
CL21○221KBANNN □		●		0.22nF	±10%	50	0.75
CL21○331KBANNN □		●		0.33nF	±10%	50	0.75
CL21○471KBANNN □		●		0.47nF	±10%	50	0.75
CL21○681KBANNN □		●		0.68nF	±10%	50	0.75
CL21○102KBANNN □		●		1.0nF	±10%	50	0.75
CL21○152KBANNN □		●		1.5nF	±10%	50	0.75
CL21○222KBANNN □		●		2.2nF	±10%	50	0.75
CL21○332KBANNN □		●		3.3nF	±10%	50	0.75
CL21○332KBCNNN □		●		3.3nF	±10%	50	0.95
CL21○472KBANNN □		●		4.7nF	±10%	50	0.75
CL21○682KBANNN □		●		6.8nF	±10%	50	0.75
CL21○103KBANNN □		●		10nF	±10%	50	0.75
CL21○103KBCNNN □		●		10nF	±10%	50	0.95
CL21○103ZBANNN □			●	10nF	+80%~-20%	50	0.75
CL21○153KBANNN □		●		15nF	±10%	50	0.75
CL21○223KBANNN □		●		22nF	±10%	50	0.75
CL21○223ZBANNN □			●	22nF	+80%~-20%	50	0.75
CL21○333KBANNN □		●		33nF	±10%	50	0.75
CL21○473ZBANNN □			●	47nF	+80%~-20%	50	0.75
CL21○683KBCNNN □		●		68nF	±10%	50	0.95
CL21○104KBCNNN □		●		100nF	±10%	50	0.95
CL21○104ZBANNN □			●	100nF	+80%~-20%	50	0.75
CL21○104ZBCNNN □			●	100nF	+80%~-20%	50	0.95
CL21○154KBFNNN □		●		150nF	±10%	50	1.35
CL21○224KBFNNN □		●		220nF	±10%	50	1.35
CL21○224ZBCNNN □			●	220nF	+80%~-20%	50	0.95
CL21○474ZBFNNN □			●	470nF	+80%~-20%	50	1.35
CL21○105KBFNNN □		●		1.0μF	±10%	50	1.35
CL21○105ZBFNNN □			●	1.0μF	+80%~-20%	50	1.35
CL21○102KAANNN □		●		1.0nF	±10%	25	0.75
CL21○103KAANNN □		●		10nF	±10%	25	0.75
CL21○473KAANNN □		●		47nF	±10%	25	0.75
CL21○683KAANNN □		●		68nF	±10%	25	0.75
CL21○104KACNNN □		●		100nF	±10%	25	0.95
CL21○104ZANNN □			●	100nF	+80%~-20%	25	0.75

※ ○ mark means temperature characteristic code. The parts with mark ● are available to produce.
 ※ □ mark means packaging code. If you want to learn the code or quantity in detail, please see p 81.

Product Line Up (General Capacitors)

Part Number	Size L×W (2.0×1.25mm)			Capacitance	Capacitance Tolerance	Rated Voltage (Vdc)	Thickness Max. (mm)
	A	B	F				
	X5R(EIA)	X7R(EIA)	Y5V(EIA)				
CL21○154KAFNNN □		●		150nF	±10%	25	1.35
CL21○224KAFNNN □		●		220nF	±10%	25	1.35
CL21○224ZAANNN □			●	220nF	+80%~-20%	25	0.75
CL21○334KAFNNN □		●		330nF	±10%	25	1.35
CL21○474KAFNNN □		●		470nF	±10%	25	1.35
CL21○474ZACNNN □			●	470nF	+80%~-20%	25	0.95
CL21○105KAFNNN □		●		1.0μF	±10%	25	1.35
CL21○105ZAFNNN □			●	1.0μF	+80%~-20%	25	1.35
CL21○225ZAFNNN □			●	2.2μF	+80%~-20%	25	1.35
CL21○153KOANNN □		●		15nF	±10%	16	0.75
CL21○333KOANNN □		●		33nF	±10%	16	0.75
CL21○104KOANNN □		●		100nF	±10%	16	0.75
CL21○104ZOANNN □			●	100nF	+80%~-20%	16	0.75
CL21○154KOANNN □		●		150nF	±10%	16	0.75
CL21○224KOCNNN □		●		220nF	±10%	16	0.95
CL21○224ZOANNN □			●	220nF	+80%~-20%	16	0.75
CL21○334KOCNNN □		●		330nF	±10%	16	0.95
CL21○474KOFNNN □		●		470nF	±10%	16	1.35
CL21○474ZOANNN □			●	470nF	+80%~-20%	16	0.75
CL21○474ZOCNNN □			●	470nF	+80%~-20%	16	0.95
CL21○684KOFNNN □		●		680nF	±10%	16	1.35
CL21○105KOFNNN □		●		1.0μF	±10%	16	1.35
CL21○105ZOCNNN □			●	1.0μF	+80%~-20%	16	0.95
CL21○105ZOFNNN □			●	1.0μF	+80%~-20%	16	1.35
CL21○225ZOFNNN □			●	2.2μF	+80%~-20%	16	1.35
CL21○475ZOFNNN □			●	4.7μF	+80%~-20%	16	1.35
CL21○474KPCNNN □		●		470nF	±10%	10	0.95
CL21○684KPFNNN □		●		680nF	±10%	10	1.35
CL21○105KPFNNN □		●		1.0μF	±10%	10	1.35
CL21○225ZPFNNN □			●	2.2μF	+80%~-20%	10	1.35
CL21○475ZPFNNN □			●	4.7μF	+80%~-20%	10	1.35

※ ○ mark means temperature characteristic code. The parts with mark ● are available to produce.
 ※ □ mark means packaging code. If you want to learn the code or quantity in detail, please see p 81.

Part Numbering System

General Capacitors

Ultra High Capacitors

Super Small Capacitors

High Voltage Capacitors

Camera Strobe Circuit Capacitors

Array Type Capacitors

Low ESL Capacitors

Reliability Test Condition

Premium Capacitors for Automotive Applications

Packaging Specification

Application Manual for Surface Mounting

Product Line Up (General Capacitors)

Part Number	Size L×W (3.2×1.6mm)			Capacitance	Capacitance Tolerance	Rated Voltage (Vdc)	Thickness Max. (mm)
	A	B	F				
	X5R(EIA)	X7R(EIA)	Y5V(EIA)				
CL31○154KBCNNN □		●		150nF	±10%	50	1.00
CL31○334KBFNNN □		●		330nF	±10%	50	1.40
CL31○474KBHNNN □		●		470nF	±10%	50	1.8
CL31○474ZBCNNN □			●	470nF	+80%~-20%	50	1.00
CL31○684KBHNNN □		●		680nF	±10%	50	1.8
CL31○105KBHNNN □		●		1.0μF	±10%	50	1.8
CL31○105ZBFNNN □			●	1.0μF	+80%~-20%	50	1.40
CL31○225KBHNNN □	●			2.2μF	±10%	50	1.8
CL31○104KACNNN □		●		100nF	±10%	25	1.00
CL31○154KACNNN □		●		150nF	±10%	25	1.00
CL31○224KACNNN □		●		220nF	±10%	25	1.00
CL31○334KACNNN □		●		330nF	±10%	25	1.00
CL31○684KAHNNN □		●		680nF	±10%	25	1.8
CL31○105KAPNNN □		●		1.0μF	±10%	25	1.25
CL31○105KAHNNN □		●		1.0μF	±10%	25	1.8
CL31○105ZACNNN □			●	1.0μF	+80%~-20%	25	1.00
CL31○225KAHNNN □	●	●		2.2μF	±10%	25	1.8
CL31○225ZAFNNN □			●	2.2μF	+80%~-20%	25	1.40
CL31○334KOCNNN □		●		330nF	±10%	16	1.00
CL31○474KOCNNN □		●		470nF	±10%	16	1.00
CL31○684KOCNNN □		●		680nF	±10%	16	1.00
CL31○105ZOCNNN □			●	1.0μF	+80%~-20%	16	1.00
CL31○155KOFNNN □		●		1.5μF	±10%	16	1.40
CL31○225KOHNNN □		●		2.2μF	±10%	16	1.8
CL31○225ZOCNNN □			●	2.2μF	+80%~-20%	16	1.00
CL31○335KOC LNN □	●			3.3μF	±10%	16	1.00
CL31○335KOHNNN □	●	●		3.3μF	±10%	16	1.8
CL31○475ZOENNN □			●	4.7μF	+80%~-20%	16	1.25
CL31○475ZOFNNN □			●	4.7μF	+80%~-20%	16	1.40
CL31○106ZOHNNN □			●	10μF	+80%~-20%	16	1.8
CL31○105KPCNNN □		●		1.0μF	±10%	10	1.00
CL31○225KPENNN □		●		2.2μF	±10%	10	1.25
CL31○475KPHNNN □		●		4.7μF	±10%	10	1.8
CL31○106ZPENNN □			●	10μF	+80%~-20%	10	1.25
CL31○106ZPFNNN □			●	10μF	+80%~-20%	10	1.40
CL31○685KQHNNN □		●		6.8μF	±10%	6.3	1.8
CL31○106KQHNNN □		●		10μF	±10%	6.3	1.8

※○mark means temperature characteristic code. The parts with mark ●are available to produce.
 ※□mark means packaging code. If you want to learn the code or quantity in detail, please see p 81.

Product Line Up (General Capacitors)

Part Number	Size L×W (3.2×2.5mm)			Capacitance	Capacitance Tolerance	Rated Voltage (Vdc)	Thickness Max. (mm)
	A	B	F				
	X5R(EIA)	X7R(EIA)	Y5V(EIA)				
CL32○474KBFNNN □		●		470nF	±10%	50	1.45
CL32B475KBUYNN □		●		4.7μF	±10%	50	2.00
CL32○105KBHNNN □		●		1.0μF	±10%	50	1.80
CL32○225KBJNNN □		●		2.2μF	±10%	50	2.70
CL32○475KBUYNN □		●		4.7μF	±10%	50	2.00
CL32○475KLULNN □	●			4.7μF	±10%	35	2.00
CL32○106KLULNN □	●			10μF	±10%	35	2.00
CL32○106ZLHNNN □			●	10μF	+80%~-20%	35	1.80
CL32○105KAFNNN □		●		1.0μF	±10%	25	1.45
CL32○225KANNNN □		●		2.2μF	±10%	25	2.20
CL32○475KAULNN □	●			4.7μF	±10%	25	2.00
CL32○475KAIINN □	●			4.7μF	±10%	25	2.20
CL32○475ZAHNNN □			●	4.7μF	+80%~-20%	25	1.80
CL32○106KA9LNN □	●			10μF	±10%	25	1.00
CL32○106KATLNN □	●			10μF	±10%	25	1.70
CL32○106KAULNN □	●			10μF	±10%	25	2.00
CL32○106KAJNNN □		●		10μF	±10%	25	2.70
CL32○106KAJSNN □		●		10μF	±10%	25	2.70
CL32○106ZAHNNN □			●	10μF	+80%~-20%	25	1.80
CL32○106ZASLNN □			●	10μF	+80%~-20%	25	1.50
CL32○475KOINN □		●		4.7μF	±10%	16	2.20
CL32○475ZO9LNN □			●	4.7μF	+80%~-20%	16	1.00
CL32○475ZOFNNN □			●	4.7μF	+80%~-20%	16	1.45
CL32○106KOC LNN □	●			10μF	±10%	16	0.95
CL32○106KO9LNN □	●			10μF	±10%	16	1.00
CL32○106KOMLNN □	●			10μF	±10%	16	1.25
CL32○106KOTLNN □	●			10μF	±10%	16	1.70
CL32○106KOJNNN □	●	●		10μF	±10%	16	2.70
CL32○106ZOELNN □			●	10μF	+80%~-20%	16	1.20
CL32○106ZOHNNN □			●	10μF	+80%~-20%	16	1.80
CL32○106ZOMLNN □			●	10	+80%~-20%	16	1.25
CL32○106KPIINN □	●	●		10μF	±10%	10	2.20

Part Number	Size L×W (4.5×3.2mm)			Capacitance	Capacitance Tolerance	Rated Voltage (Vdc)	Thickness Max. (mm)
	A	B	F				
	X5R(EIA)	X7R(EIA)	Y5V(EIA)				
CL43○684KBFNNN □		●		680nF	±10%	50	1.45
CL43○105KBFNNN □		●		1μF	±10%	50	1.45
CL43○106KALNNN □		●		10μF	±10%	25	3.40

Part Number	Size L×W (5.7×5.0mm)			Capacitance	Capacitance Tolerance	Rated Voltage (Vdc)	Thickness Max. (mm)
	A	B	F				
	X5R(EIA)	X7R(EIA)	Y5V(EIA)				
CL55○105KBINN □		●		1μF	±10%	50	2.20
CL55○476KPJNNN □	●			47μF	±10%	10	2.70
CL55○107KQJNNN □	●			100μF	±10%	6.3	2.70
CL55○107ZPJNNN □			●	100μF	+80%~-20%	10	2.70

※○mark means temperature characteristic code. The parts with mark ●are available to produce.
 ※□mark means packaging code. If you want to learn the code or quantity in detail, please see p 81.

Part Numbering System

General Capacitors

Ultra High Capacitors

Super Small Capacitors

High Voltage Capacitors

Camera Strobe Circuit Capacitors

Array Type Capacitors

Low ESL Capacitors

Reliability Test Condition

Premium Capacitors for Automotive Applications

Packaging Specification

Application Manual for Surface Mounting

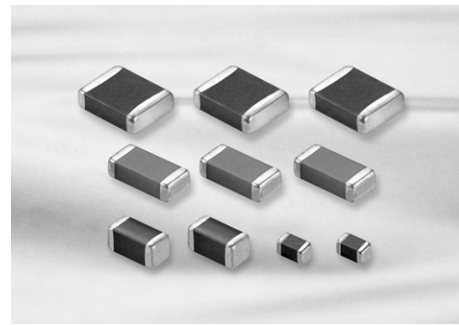

Feature

- Wide selection of size : from 0402 to 1812
- Highly reliable tolerance and high speed automatic chip placement on PCBs
- Wide capacitance range
- Highly reliable performance
- Highly resistant termination metal
- Tape & reel for surface mount assembly

Application

- Desktop PC, Note PC, HHP, DC-DC Converter, DSC
- LCD TV, LCD Monitor
- ※ For using special purpose like Military, Medical, Aviation, Automobile device should be following a special specification.

Structure and Dimensions

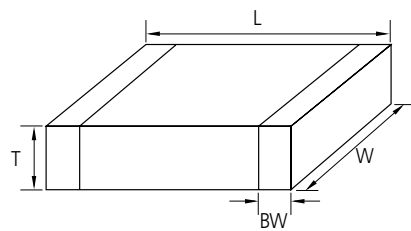

Size Code	EIA Code	Dimension(mm)				
		L	W	T	Thickness Code	BW
05	0402	1.00±0.05	0.50±0.05	0.50±0.05	5	0.2+0.15/-0.1
10	0603	1.60±0.10	0.80±0.10	0.50±0.05	5	0.30±0.20
				0.80±0.10	8	
21	0805	2.00±0.10	1.25±0.10	0.85±0.10	C	0.5+0.2/-0.3
				1.25±0.10	F	
				1.25±0.15	Q	
31	1206	3.20±0.20	1.60±0.20	0.60±0.10	6	0.50+0.30
				0.85±0.10	C	
				1.15±0.10	P	
32	1210	3.20±0.15	1.60±0.15	1.25±0.15	F	0.60±0.30
				1.60±0.20	H	
				0.85±0.10	C	
42	1808	4.50±0.40	2.00±0.20	0.90±0.10	9	0.80±0.30
				1.60±0.20	H	
				1.80±0.20	U	
				2.00±0.20	I	
				2.50±0.20	J	
43	1812	4.50±0.40	3.20±0.30	2.50±0.30	v	0.80±0.30
43	1812	4.50±0.40	3.20±0.30	3.20±0.30	L	0.80±0.30

Capacitance Table (Ultra High Capacitors)

Size	0402(05)				0603(10)				
	X5R(A)								
TC	4(R)	6.3(Q)	10(P)	16(O)	4(R)	6.3(Q)	10(P)	16(O)	25(A)
Rated V	Capacitance -nF- (part numbering code) and thickness -mm-								
0.10(101)									
0.15(151)									
0.22(221)									
0.33(331)									
0.47(471)									
0.68(681)									
1.0(102)									
1.5(152)									
2.2(222)									
3.3(332)									
4.7(472)									
6.8(682)									
10(103)									
15(153)									
22(223)									
33(333)									
47(473)									
68(683)									
100(104)									
150(154)									
220(224)									
330(334)									
470(474)									
680(684)									
1000(105)									
1500(155)									
2200(225)									
3300(335)									
4700(475)									
10000(106)									
22000(226)									

■:X7R(B) ■:X5R(A) ■:Y5V(F) ■:C0G(C) ■:X6S(X)

- Part Numbering System
- General Capacitors
- Ultra High Capacitors
- Super Small Capacitors
- High Voltage Capacitors
- Camera Strobe Circuit Capacitors
- Array Type Capacitors
- Low ESL Capacitors
- Reliability Test Condition
- Premium Capacitors for Automotive Applications
- Packaging Specification
- Application Manual for Surface Mounting

Capacitance Table (Ultra High Capacitors)

Size	0805(21)				1206(31)				1210(32)				1812(43)	
	X5R(A)													
TC														
Rated V	4(R)	6.3(Q)	10(P)	16(O)	25(A)	6.3(Q)	10(P)	16(O)	25(A)	6.3(Q)	10(P)	16(O)	25(A)	6.3(Q)
Capacitance -nF- (part numbering code) and thickness -mm-														
0.15(151)														
0.22(221)														
0.33(331)														
0.47(471)														
0.68(681)														
1.0(102)														
1.5(152)														
2.2(222)														
3.3(332)														
4.7(472)														
6.8(682)														
10(103)														
15(153)														
22(223)														
33(333)														
47(473)														
68(683)														
100(104)														
150(154)														
220(224)														
330(334)														
390(394)														
470(474)														
680(684)														
1000(105)					0.6 (6)									
1500(155)					0.85 (C)									
2200(225)					0.85 (C)									
3300(335)					0.85 (C)									
4700(475)					0.85 (C)									
6800(685)					0.85 (C)									
10000(106)					1.25 (Y)									
15000(156)					1.6 (H)									
22000(226)	0.85 (C)				1.25 (Y)									
47000(476)	1.25 (Y)				1.25 (Y)									
68000(686)					1.6 (H)									
100000(107)					2.5 (J)									

Capacitance Table (Ultra High Capacitors)

Size	0402(05)	0603(10)		0805(21)				
	X7R(B) / X6S(X)							
TC								
Rated V	6.3(Q)	4(R)	6.3(Q)	4(R)	6.3(Q)	10(P)	16(O)	25(A)
Capacitance -nF- (part numbering code) and thickness -mm-								
2.2(222)								
4.7(472)								
10(103)								
22(223)								
47(473)								
100(104)								
220(224)								
470(474)								
1000(105)	0.5 (5)		0.8 (8)					
2200(225)			0.8 (8)		1.25 (F)		1.25 (F)	
4700(475)		0.8 (8)	0.8 (8)		1.25 (Q)	0.85 (C)	1.25 (Y)	
10000(106)				0.85 (C)	1.25 (Q)			1.25 (Y)
22000(226)				1.25 (Y)				
47000(476)								
100000(107)								

Size	1206(31)			1210(32)	0402(05)	0603(10)	0805(21)	1206(31)	1210(32)	
	X7R(B) / X6S(X)				Y5V(F)					
TC										
Rated V	6.3(Q)	6.3(O)	25(A)	6.3(Q)	6.3(Q)	6.3(Q)	10(P)	10(P)	6.3(Q)	10(P)
Capacitance -nF- (part numbering code) and thickness -mm-										
2.2(222)										
4.7(472)										
10(103)										
22(223)										
47(473)										
100(104)										
220(224)										
470(474)										
1000(105)						0.50 (5)				
2200(225)							0.80 (5)			
4700(475)							0.80 (5)			
10000(106)	1.6 (H)	1.6 (H)		1.6 (H)				1.25 (F)		
22000(226)				2.5 (J)					1.6 (H)	2.5 (J)
47000(476)										
100000(107)										

Part Numbering System

General Capacitors

Ultra High Capacitors

Super Small Capacitors

High Voltage Capacitors

Camera Strobe Circuit Capacitors

Array Type Capacitors

Low ESL Capacitors

Reliability Test Condition

Premium Capacitors for Automotive Applications

Packaging Specification

Application Manual for Surface Mounting

Product Line Up (Ultra High Capacitors)

Part Number	TC Code	Temperature Characteristics	Size L × W (mm)	Capacitance	Capacitance Tolerance	Rated Voltage (Vdc)	Thickness Max. (mm)
CL05A334KA5NNN □	X5R(EIA)	±15%(-55~+85℃)	1.00 × 0.50	0.33 μF	±10%	25	0.55
CL10A474KA8NNN □	X5R(EIA)	±15%(-55~+85℃)	1.60 × 0.80	0.47 μF	±10%	25	0.90
CL10A105KA5NNN □	X5R(EIA)	±15%(-55~+85℃)	1.60 × 0.80	1.0 μF	±10%	25	0.55
CL21A105KACLNN □	X5R(EIA)	±15%(-55~+85℃)	2.00 × 1.25	1.0 μF	±10%	25	0.95
CL21A105KAFNNN □	X5R(EIA)	±15%(-55~+85℃)	2.00 × 1.25	1.0 μF	±10%	25	1.35
CL10A225KA5LNN □	X5R(EIA)	±15%(-55~+85℃)	1.60 × 0.80	2.2 μF	±10%	25	0.55
CL21A225KACLNN □	X5R(EIA)	±15%(-55~+85℃)	2.00 × 1.25	2.2 μF	±10%	25	0.95
CL21A225KAFNNN □	X5R(EIA)	±15%(-55~+85℃)	2.00 × 1.25	2.2 μF	±10%	25	1.35
CL21A475KACLNN □	X5R(EIA)	±15%(-55~+85℃)	2.00 × 1.25	4.7 μF	±10%	25	0.95
CL31A475KACLNN □	X5R(EIA)	±15%(-55~+85℃)	3.20 × 1.60	4.7 μF	±10%	25	0.95
CL31A475KAPLNN □	X5R(EIA)	±15%(-55~+85℃)	3.20 × 1.60	4.7 μF	±10%	25	1.25
CL31A475KAHNNN □	X5R(EIA)	±15%(-55~+85℃)	3.20 × 1.60	4.7 μF	±10%	25	1.80
CL21A106KAYNNN □	X5R(EIA)	±15%(-55~+85℃)	2.00 × 1.25	10 μF	±10%	25	1.45
CL31A106KACLNN □	X5R(EIA)	±15%(-55~+85℃)	3.20 × 1.60	10 μF	±10%	25	0.95
CL31A106KAHNNN □	X5R(EIA)	±15%(-55~+85℃)	3.20 × 1.60	10 μF	±10%	25	1.80
CL31A226KAHNNN □	X5R(EIA)	±15%(-55~+85℃)	3.20 × 1.60	22 μF	±10%	25	1.80
CL32A226KAJNNN □	X5R(EIA)	±15%(-55~+85℃)	3.20 × 2.50	22 μF	±10%	25	2.70
CL10A474KO8NNN □	X5R(EIA)	±15%(-55~+85℃)	1.60 × 0.80	0.47 μF	±10%	16	0.90
CL05A105KO5NNN □	X5R(EIA)	±15%(-55~+85℃)	1.00 × 0.50	1.0 μF	±10%	16	0.55
CL10A105KO5LNN □	X5R(EIA)	±15%(-55~+85℃)	1.60 × 0.80	1.0 μF	±10%	16	0.55
CL10A105KO8NNN □	X5R(EIA)	±15%(-55~+85℃)	1.60 × 0.80	1.0 μF	±10%	16	0.90
CL21A105KO6LNN □	X5R(EIA)	±15%(-55~+85℃)	2.00 × 1.25	1.0 μF	±10%	16	0.70
CL21A105KOFNNN □	X5R(EIA)	±15%(-55~+85℃)	2.00 × 1.25	1.0 μF	±10%	16	1.35
CL10A225KO5LNN □	X5R(EIA)	±15%(-55~+85℃)	1.60 × 0.80	2.2 μF	±10%	16	0.55
CL10A225KO8NNN □	X5R(EIA)	±15%(-55~+85℃)	1.60 × 0.80	2.2 μF	±10%	16	0.90
CL21A225KOFNNN □	X5R(EIA)	±15%(-55~+85℃)	2.00 × 1.25	2.2 μF	±10%	16	1.35
CL10A475KO8NNN □	X5R(EIA)	±15%(-55~+85℃)	1.60 × 0.80	4.7 μF	±10%	16	0.90
CL21A475KOFNNN □	X5R(EIA)	±15%(-55~+85℃)	2.00 × 1.25	4.7 μF	±10%	16	1.35
CL31A475KOCLNN □	X5R(EIA)	±15%(-55~+85℃)	3.20 × 1.60	4.7 μF	±10%	16	0.95
CL31A475KOHNNN □	X5R(EIA)	±15%(-55~+85℃)	3.20 × 1.60	4.7 μF	±10%	16	1.80
CL21A106KOCLNN □	X5R(EIA)	±15%(-55~+85℃)	2.00 × 1.25	10 μF	±10%	16	0.95
CL21A106KQNNN □	X5R(EIA)	±15%(-55~+85℃)	2.00 × 1.25	10 μF	±10%	16	1.40
CL31A106KOCLNN □	X5R(EIA)	±15%(-55~+85℃)	3.20 × 1.60	10 μF	±10%	16	0.95
CL31A106KOHNNN □	X5R(EIA)	±15%(-55~+85℃)	3.20 × 1.60	10 μF	±10%	16	1.80
CL31A226KOCLNN □	X5R(EIA)	±15%(-55~+85℃)	3.20 × 1.60	22 μF	±10%	16	0.95
CL32A226KOJNNN □	X5R(EIA)	±15%(-55~+85℃)	3.20 × 2.50	22 μF	±10%	16	2.70
CL05A224KP5NNN □	X5R(EIA)	±15%(-55~+85℃)	1.00 × 0.50	0.22 μF	±10%	10	0.55
CL05A474KP5NNN □	X5R(EIA)	±15%(-55~+85℃)	1.00 × 0.50	0.47 μF	±10%	10	0.55
CL10A684KP8NNN □	X5R(EIA)	±15%(-55~+85℃)	1.60 × 0.80	0.68 μF	±10%	10	0.90
CL05A105KP5NNN □	X5R(EIA)	±15%(-55~+85℃)	1.00 × 0.50	1.0 μF	±10%	10	0.55
CL21A105KPFNNN □	X5R(EIA)	±15%(-55~+85℃)	2.00 × 1.25	1.0 μF	±10%	10	1.35
CL05A225MP5NSN □	X5R(EIA)	±15%(-55~+85℃)	1.00 × 0.50	2.2 μF	±20%	10	0.55
CL10A225KP8NNN □	X5R(EIA)	±15%(-55~+85℃)	1.60 × 0.80	2.2 μF	±10%	10	0.90
CL21A225KPENNN □	X5R(EIA)	±15%(-55~+85℃)	2.00 × 1.25	2.2 μF	±10%	10	1.20
CL21A225KPFNNN □	X5R(EIA)	±15%(-55~+85℃)	2.00 × 1.25	2.2 μF	±10%	10	1.35
CL10A475KP5LNN □	X5R(EIA)	±15%(-55~+85℃)	1.60 × 0.80	4.7 μF	±10%	10	0.55
CL10A475KP8NNN □	X5R(EIA)	±15%(-55~+85℃)	1.60 × 0.80	4.7 μF	±10%	10	0.90

※ □mark means packaging code. If you want to learn the code or quantity in detail, please see p 81.

Product Line Up (Ultra High Capacitors)

Part Number	TC Code	Temperature Characteristics	Size L × W (mm)	Capacitance	Capacitance Tolerance	Rated Voltage (Vdc)	Thickness Max. (mm)
CL21A475KPCLNN □	X5R(EIA)	±15%(-55~+85℃)	2.00 × 1.25	4.7 μF	±10%	10	0.95
CL21A475KPFNNN □	X5R(EIA)	±15%(-55~+85℃)	2.00 × 1.25	4.7 μF	±10%	10	1.35
CL31A475KP6LNN □	X5R(EIA)	±15%(-55~+85℃)	3.20 × 1.60	4.7 μF	±10%	10	0.70
CL10A106KP8NNN □	X5R(EIA)	±15%(-55~+85℃)	1.60 × 0.80	10 μF	±10%	10	0.90
CL21A106KPCLQN □	X5R(EIA)	±15%(-55~+85℃)	2.00 × 1.25	10 μF	±10%	10	0.95
CL21A106KPFNNN □	X5R(EIA)	±15%(-55~+85℃)	2.00 × 1.25	10 μF	±10%	10	1.35
CL31A106KPLLNN □	X5R(EIA)	±15%(-55~+85℃)	3.20 × 1.60	10 μF	±10%	10	1.25
CL31A106KPHNNN □	X5R(EIA)	±15%(-55~+85℃)	3.20 × 1.60	10 μF	±10%	10	1.80
CL21A226MPCLRN □	X5R(EIA)	±15%(-55~+85℃)	2.00 × 1.25	22 μF	±10%	10	0.95
CL31A106KPCLNN □	X5R(EIA)	±15%(-55~+85℃)	3.20 × 1.60	22 μF	±10%	10	0.95
CL31A226KPHNNN □	X5R(EIA)	±15%(-55~+85℃)	3.20 × 1.60	22 μF	±10%	10	1.80
CL32A226KPJNNN □	X5R(EIA)	±15%(-55~+85℃)	3.20 × 2.50	22 μF	±10%	10	2.70
CL05A224KQ5NNN □	X5R(EIA)	±15%(-55~+85℃)	1.00 × 0.50	0.22 μF	±10%	6.3	0.55
CL05A334KQ5NNN □	X5R(EIA)	±15%(-55~+85℃)	1.00 × 0.50	0.33 μF	±10%	6.3	0.55
CL05A474KQ5NNN □	X5R(EIA)	±15%(-55~+85℃)	1.00 × 0.50	0.47 μF	±10%	6.3	0.55
CL05A105KQ5NNN □	X5R(EIA)	±15%(-55~+85℃)	1.00 × 0.50	1.0 μF	±10%	6.3	0.55
CL05A225MQ5NSN □	X5R(EIA)	±15%(-55~+85℃)	1.00 × 0.50	2.2 μF	±20%	6.3	0.57
CL10A225KQ5LNN □	X5R(EIA)	±15%(-55~+85℃)	1.60 × 0.80	2.2 μF	±10%	6.3	0.55
CL10A225KQ8NNN □	X5R(EIA)	±15%(-55~+85℃)	1.60 × 0.80	2.2 μF	±10%	6.3	0.90
CL10A335KQ8NNN □	X5R(EIA)	±15%(-55~+85℃)	1.60 × 0.80	3.3 μF	±10%	6.3	0.90
CL05A475MQ5NRN □	X5R(EIA)	±15%(-55~+85℃)	1.00 × 0.50	4.7 μF	±20%	6.3	0.65
CL10A475KQ5LNN □	X5R(EIA)	±15%(-55~+85℃)	1.60 × 0.80	4.7 μF	±10%	6.3	0.55
CL10A475KQ8NNN □	X5R(EIA)	±15%(-55~+85℃)	1.60 × 0.80	4.7 μF	±10%	6.3	0.90
CL21A475KQCLNN □	X5R(EIA)	±15%(-55~+85℃)	2.00 × 1.25	4.7 μF	±10%	6.3	0.95
CL21A475KQFNNN □	X5R(EIA)	±15%(-55~+85℃)	2.00 × 1.25	4.7 μF	±10%	6.3	1.35
CL10A106KQ8NNN □	X5R(EIA)	±15%(-55~+85℃)	1.60 × 0.80	10 μF	±10%	6.3	0.90
CL21A106KQCLNN □	X5R(EIA)	±15%(-55~+85℃)	2.00 × 1.25	10 μF	±10%	6.3	0.95
CL21A106KQFNNN □	X5R(EIA)	±15%(-55~+85℃)	2.00 × 1.25	10 μF	±10%	6.3	1.35
CL31A106KQHNNN □	X5R(EIA)	±15%(-55~+85℃)	3.20 × 1.60	10 μF	±10%	6.3	1.80
CL31A156KQHNNN □	X5R(EIA)	±15%(-55~+85℃)	3.20 × 1.60	15 μF	±10%	6.3	1.80
CL10A226MQ8NRN □	X5R(EIA)	±15%(-55~+85℃)	1.60 × 0.80	22 μF	±20%	6.3	1.00
CL21A226MQCLRN □	X5R(EIA)	±15%(-55~+85℃)	2.00 × 1.25	22 μF	±20%	6.3	0.95
CL21A226MQQNNN □	X5R(EIA)	±15%(-55~+85℃)	2.00 × 1.25	22 μF	±20%	6.3	1.40
CL31A226KQHNNN □	X5R(EIA)	±15%(-55~+85℃)	3.20 × 1.60	22 μF	±10%	6.3	1.80
CL32A226MQCLNN □	X5R(EIA)	±15%(-55~+85℃)	3.20 × 2.50	22 μF	±20%	6.3	0.95
CL32A226KQJNNN □	X5R(EIA)	±15%(-55~+85℃)	3.20 × 2.50	22 μF	±10%	6.3	2.70
CL21A476MQYNNN □	X5R(EIA)	±15%(-55~+85℃)	2.00 × 1.25	47 μF	±20%	6.3	1.45
CL31A476MQHNNN □	X5R(EIA)	±15%(-55~+85℃)	3.20 × 1.60	47 μF	±20%	6.3	1.80
CL32A476MQJNNN □	X5R(EIA)	±15%(-55~+85℃)	3.20 × 2.50	47 μF	±20%	6.3	2.70
CL43A476MQJNNN □	X5R(EIA)	±15%(-55~+85℃)	4.50 × 3.20	47 μF	±20%	6.3	2.70
CL32A107MQVNNN □	X5R(EIA)	±15%(-55~+85℃)	3.20 × 2.50	100 μF	±20%	6.3	2.80
CL43A107KQLNNN □	X5R(EIA)	±15%(-55~+85℃)	4.50 × 3.20	100 μF	±20%	6.3	3.50
CL05A225MR5NNN □	X5R(EIA)	±15%(-55~+85℃)	1.00 × 0.50	2.2 μF	±20%	4	0.55
CL10A106KR8NNN □	X5R(EIA)	±15%(-55~+85℃)	1.60 × 0.80	10 μF	±10%	4	0.90
CL10A226MR8NQN □	X5R(EIA)	±15%(-55~+85℃)	1.60 × 0.80	22 μF	±20%	4	0.95
CL21A476MR5YNNN □	X5R(EIA)	±15%(-55~+85℃)	2.00 × 1.25	47 μF	±20%	4	1.45

※ □mark means packaging code. If you want to learn the code or quantity in detail, please see p 81.

Part Numbering System

General Capacitors

Ultra High Capacitors

Super Small Capacitors

High Voltage Capacitors

Camera Strobe Circuit Capacitors

Array Type Capacitors

Low ESL Capacitors

Reliability Test Condition

Premium Capacitors for Automotive Applications

Packaging Specification

Application Manual for Surface Mounting

Product Line Up (Ultra High Capacitors)

Part Number	TC Code	Temperature Characteristics	Size L × W (mm)	Capacitance	Capacitance Tolerance	Rated Voltage (Vdc)	Thickness Max. (mm)
CL21X106KAYNNN □	X6S(EIA)	±22%(-55~+105℃)	2.00 × 1.25	10 μ F	±10%	25	1.45
CL31X106KAHNNN □	X6S(EIA)	±22%(-55~+105℃)	3.20 × 1.60	10 μ F	±10%	25	1.80
CL21X106KOYNNN □	X6S(EIA)	±22%(-55~+105℃)	2.00 × 1.25	10 μ F	±10%	16	1.45
CL21X106KPCLNN □	X6S(EIA)	±22%(-55~+105℃)	2.00 × 1.25	10 μ F	±10%	10	0.95
CL05X105KQ5NNN □	X6S(EIA)	±22%(-55~+105℃)	1.00 × 0.50	1.0 μ F	±10%	6.3	0.55
CL10X105KQ8NNN □	X6S(EIA)	±22%(-55~+105℃)	1.60 × 0.80	1.0 μ F	±10%	6.3	0.90
CL21X225KQFNNN □	X6S(EIA)	±22%(-55~+105℃)	2.00 × 1.25	2.2 μ F	±10%	6.3	1.35
CL21X475KQFNNN □	X6S(EIA)	±22%(-55~+105℃)	2.00 × 1.25	4.7 μ F	±10%	6.3	1.35
CL10X106KQ8NNN □	X5R(EIA)	±15%(-55~+85℃)	1.60 × 0.80	10 μ F	±10%	6.3	0.90
CL21X106KQNNNN □	X6S(EIA)	±22%(-55~+105℃)	2.00 × 1.25	10 μ F	±10%	6.3	1.40
CL31X106KQHNNN □	X6S(EIA)	±22%(-55~+105℃)	3.20 × 1.60	10 μ F	±10%	6.3	1.80
CL21X226KQNNNN □	X6S(EIA)	±22%(-55~+105℃)	2.00 × 1.25	22 μ F	±10%	6.3	1.40
CL21X106KRCLNN □	X6S(EIA)	±22%(-55~+105℃)	2.00 × 1.25	10 μ F	±10%	4	0.95
CL31B475KAHNNN □	X7R(EIA)	±15%(-55~+125℃)	3.20 × 1.60	4.7 μ F	±10%	25	1.80
CL31B106KAHNNN □	X7R(EIA)	±15%(-55~+125℃)	3.20 × 1.60	10 μ F	±10%	25	1.80
CL31B475KOHNNN □	X7R(EIA)	±15%(-55~+125℃)	3.20 × 1.60	4.7 μ F	±10%	16	1.80
CL31B106KOHNNN □	X7R(EIA)	±15%(-55~+125℃)	3.20 × 1.60	10 μ F	±10%	16	1.80
CL21B225KQFNNN □	X7R(EIA)	±15%(-55~+125℃)	2.00 × 1.25	2.2 μ F	±10%	10	1.35
CL21B225KPFNNN □	X7R(EIA)	±15%(-55~+125℃)	2.00 × 1.25	2.2 μ F	±10%	10	1.35
CL21B106KQNNNN □	X7R(EIA)	±15%(-55~+125℃)	2.00 × 1.25	10 μ F	±10%	6.3	1.35
CL31B106KQHNNN □	X7R(EIA)	±15%(-55~+125℃)	3.20 × 1.60	10 μ F	±10%	6.3	1.80
CL32B226KQJNNN □	X7R(EIA)	±15%(-55~+125℃)	3.20 × 2.50	22 μ F	±10%	6.3	2.70

Part Number	TC Code	Temperature Characteristics	Size L × W (mm)	Capacitance	Capacitance Tolerance	Rated Voltage (Vdc)	Thickness Max. (mm)
CL10F225ZP8NNN □	Y5V(EIA)	-82~+22%(-30~+85℃)	1.60 × 0.80	2.2 μ F	80% / -20%	10	0.90
CL21F106ZPFNNN □	Y5V(EIA)	-82~+22%(-30~+85℃)	2.00 × 1.25	10 μ F	80% / -20%	10	1.35
CL31F226ZPHNNN □	Y5V(EIA)	-82~+22%(-30~+85℃)	3.20 × 1.60	22 μ F	80% / -20%	10	1.80
CL32F226ZPJNNN □	Y5V(EIA)	-82~+22%(-30~+85℃)	3.20 × 2.50	22 μ F	80% / -20%	10	2.70
CL05F105ZQ5NNN □	Y5V(EIA)	-82~+22%(-30~+85℃)	1.00 × 0.50	1.0 μ F	80% / -20%	6.3	0.55
CL10F475ZQ8NNN □	Y5V(EIA)	-82~+22%(-30~+85℃)	1.60 × 0.80	4.7 μ F	80% / -20%	6.3	0.90
CL32F107ZQJNNN □	Y5V(EIA)	-82~+22%(-30~+85℃)	3.20 × 2.50	100 μ F	80% / -20%	6.3	2.70

※ □ mark means packaging code. If you want to learn the code or quantity in detail, please see p 81.

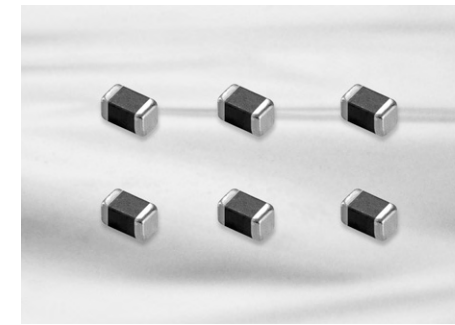

Feature

- Small chip size
- 03 Series(COG) MLCC shows very low ESR value.
- 02 and 03 Series are suited to only reflow soldering
- 02 and 03 Series are suited to miniature RF module, portable equipment and high frequency circuit

Application

- VCO, Tuner, RF Module
- MCM Module
- Mobile phone, Wireless LAN, Note PC
- ※ For using special purpose like Military, Medical, Aviation, Automobile device should be following a special specification.

Structure and Dimensions

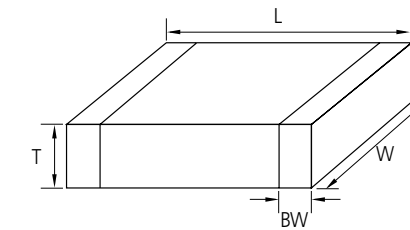

Code	EIA Code	Dimension(mm)			
		L	W	T	BW
02	01005	0.4 ± 0.02	0.2 ± 0.02	0.2 ± 0.02	0.07~0.14
03	0201	0.6 ± 0.03	0.3 ± 0.03	0.3 ± 0.03	0.15 ± 0.05

Part Numbering System

General Capacitors

Ultra High Capacitors

Super Small Capacitors

High Voltage Capacitors

Camera Strobe Circuit Capacitors

Array Type Capacitors

Low ESL Capacitors

Reliability Test Condition

Premium Capacitors for Automotive Applications

Packaging Specification

Application Manual for Surface Mounting

Capacitance Table (Super Small Size Capacitors)

Size	01005(02)					0201(03)					
	TC	COG		X7R(B) / X5R(A)		COG(C)		X7R(B) / X5R(A)			Y5V(F)
		Rated V	6.3(Q)	16V(O)	6.3(Q)	10(P)	25(A)	50(B)	6.3(Q)	10(P)	
Capacitance -pF- (part numbering code) and thickness -mm- (part numbering code)											
0.5(0R5)											
0.75(R75)											
1.0(010)											
2.0(020)											
3.0(030)											
4.0(040)											
5.0(050)											
6.0(060)											
7.0(070)							0.3 (3)				
8.0(080)											
9.0(090)			0.2 (2)								
10(100)											
12(120)											
15(150)											
18(180)											
20(200)											
22(220)											
27(270)											
33(330)											
39(390)											
47(470)											
56(560)							0.3 (3)				
68(680)		0.2 (2)									
82(820)											
100(101)											
150(151)											
220(221)											
330(331)					0.2 (2)					0.3 (3)	
470(471)											
680(681)											
1000(102)					0.2 (2)						
1500(152)											
2200(222)											
3300(332)											
4700(472)									0.3 (3)		
6800(682)											
10000(103)											
15000(153)											
22000(223)											
33000(333)											
47000(473)											
68000(683)											
100000(104)									0.3 (3)	0.3 (3)	0.3 (3)
220000(224)											

■ :X7R(B) ■ :X5R(A) ■ :Y5V(F) ■ :COG(C) ■ :X6S(X)

Product Line Up (Super Small Size Capacitors)

Part Number	TC Code	Temperature Characteristics	Size L×W (mm)	Capacitance	Capacitance Tolerance	Rated Voltage (Vdc)	Thickness Max. (mm)	Remark
CL03C0R5CA3GNN □	COG(EIA)	±30ppm/°C(-55~+125°C)	0.60×0.30	0.5pF	±0.25pF	25	0.33	High-Q
CL03C010CA3GNN □	COG(EIA)	±30ppm/°C(-55~+125°C)	0.60×0.30	1.0pF	±0.25pF	25	0.33	High-Q
CL03C1R2CA3GNN □	COG(EIA)	±30ppm/°C(-55~+125°C)	0.60×0.30	1.2pF	±0.25pF	25	0.33	High-Q
CL03C1R5CA3GNN □	COG(EIA)	±30ppm/°C(-55~+125°C)	0.60×0.30	1.5pF	±0.25pF	25	0.33	High-Q
CL03C1R8CA3GNN □	COG(EIA)	±30ppm/°C(-55~+125°C)	0.60×0.30	1.8pF	±0.25pF	25	0.33	High-Q
CL03C020CA3GNN □	COG(EIA)	±30ppm/°C(-55~+125°C)	0.60×0.30	2.0pF	±0.25pF	25	0.33	High-Q
CL03C2R2CA3GNN □	COG(EIA)	±30ppm/°C(-55~+125°C)	0.60×0.30	2.2pF	±0.25pF	25	0.33	High-Q
CL03C2R7CA3GNN □	COG(EIA)	±30ppm/°C(-55~+125°C)	0.60×0.30	2.7pF	±0.25pF	25	0.33	High-Q
CL03C030CA3GNN □	COG(EIA)	±30ppm/°C(-55~+125°C)	0.60×0.30	3.0pF	±0.25pF	25	0.33	High-Q
CL03C3R3CA3GNN □	COG(EIA)	±30ppm/°C(-55~+125°C)	0.60×0.30	3.3pF	±0.25pF	25	0.33	High-Q
CL03C3R9CA3GNN □	COG(EIA)	±30ppm/°C(-55~+125°C)	0.60×0.30	3.9pF	±0.25pF	25	0.33	High-Q
CL03C4R7CA3GNN □	COG(EIA)	±30ppm/°C(-55~+125°C)	0.60×0.30	4.7pF	±0.25pF	25	0.33	High-Q
CL03C5R6DA3GNN □	COG(EIA)	±30ppm/°C(-55~+125°C)	0.60×0.30	5.6pF	±0.5pF	25	0.33	High-Q
CL03C6R8DA3GNN □	COG(EIA)	±30ppm/°C(-55~+125°C)	0.60×0.30	6.8pF	±0.5pF	25	0.33	High-Q
CL03C8R2DA3GNN □	COG(EIA)	±30ppm/°C(-55~+125°C)	0.60×0.30	8.2pF	±0.5pF	25	0.33	High-Q
CL03C090DA3GNN □	COG(EIA)	±30ppm/°C(-55~+125°C)	0.60×0.30	9.0pF	±0.5pF	25	0.33	High-Q
CL03C100JA3GNN □	COG(EIA)	±30ppm/°C(-55~+125°C)	0.60×0.30	10pF	±5%	25	0.33	High-Q
CL03C150JA3GNN □	COG(EIA)	±30ppm/°C(-55~+125°C)	0.60×0.30	15pF	±5%	25	0.33	High-Q
CL03C180JA3GNN □	COG(EIA)	±30ppm/°C(-55~+125°C)	0.60×0.30	18pF	±5%	25	0.33	High-Q
CL03C220JA3GNN □	COG(EIA)	±30ppm/°C(-55~+125°C)	0.60×0.30	22pF	±5%	25	0.33	High-Q
CL03C270JA3GNN □	COG(EIA)	±30ppm/°C(-55~+125°C)	0.60×0.30	27pF	±5%	25	0.33	High-Q
CL03C330JA3GNN □	COG(EIA)	±30ppm/°C(-55~+125°C)	0.60×0.30	33pF	±5%	25	0.33	High-Q
CL03C390JA3ANN □	COG(EIA)	±30ppm/°C(-55~+125°C)	0.60×0.30	39pF	±5%	25	0.33	
CL03C470JA3ANN □	COG(EIA)	±30ppm/°C(-55~+125°C)	0.60×0.30	47pF	±5%	25	0.33	
CL03C101JA3ANN □	COG(EIA)	±30ppm/°C(-55~+125°C)	0.60×0.30	100pF	±5%	25	0.33	
CL02C0R5CO2ANN □	COG(EIA)	±30ppm/°C(-55~+125°C)	0.40×0.20	0.5pF	±0.25pF	16	0.22	
CL02C010CO2ANN □	COG(EIA)	±30ppm/°C(-55~+125°C)	0.40×0.20	1.0pF	±0.25pF	16	0.22	
CL02C1R2CO2ANN □	COG(EIA)	±30ppm/°C(-55~+125°C)	0.40×0.20	1.2pF	±0.25pF	16	0.22	
CL02C1R5CO2ANN □	COG(EIA)	±30ppm/°C(-55~+125°C)	0.40×0.20	1.5pF	±0.25pF	16	0.22	
CL02C1R8CO2ANN □	COG(EIA)	±30ppm/°C(-55~+125°C)	0.40×0.20	1.8pF	±0.25pF	16	0.22	
CL02C020CO2ANN □	COG(EIA)	±30ppm/°C(-55~+125°C)	0.40×0.20	2.0pF	±0.25pF	16	0.22	
CL02C2R2CO2ANN □	COG(EIA)	±30ppm/°C(-55~+125°C)	0.40×0.20	2.2pF	±0.25pF	16	0.22	
CL02C2R7CO2ANN □	COG(EIA)	±30ppm/°C(-55~+125°C)	0.40×0.20	2.7pF	±0.25pF	16	0.22	
CL02C030CO2ANN □	COG(EIA)	±30ppm/°C(-55~+125°C)	0.40×0.20	3.0pF	±0.25pF	16	0.22	
CL02C3R3CO2ANN □	COG(EIA)	±30ppm/°C(-55~+125°C)	0.40×0.20	3.3pF	±0.25pF	16	0.22	
CL02C3R9CO2ANN □	COG(EIA)	±30ppm/°C(-55~+125°C)	0.40×0.20	3.9pF	±0.25pF	16	0.22	
CL02C4R7CO2ANN □	COG(EIA)	±30ppm/°C(-55~+125°C)	0.40×0.20	4.7pF	±0.25pF	16	0.22	
CL02C5R6DO2ANN □	COG(EIA)	±30ppm/°C(-55~+125°C)	0.40×0.20	5.6pF	±0.5pF	16	0.22	
CL02C6R8DO2ANN □	COG(EIA)	±30ppm/°C(-55~+125°C)	0.40×0.20	6.8pF	±0.5pF	16	0.22	
CL02C8R2DO2ANN □	COG(EIA)	±30ppm/°C(-55~+125°C)	0.40×0.20	8.2pF	±0.5pF	16	0.22	
CL02C090DO2ANN □	COG(EIA)	±30ppm/°C(-55~+125°C)	0.40×0.20	9.0pF	±0.5pF	16	0.22	
CL02C100JO2ANN □	COG(EIA)	±30ppm/°C(-55~+125°C)	0.40×0.20	10pF	±5%	16	0.22	
CL02C150JO2ANN □	COG(EIA)	±30ppm/°C(-55~+125°C)	0.40×0.20	15pF	±5%	16	0.22	
CL02C180JO2ANN □	COG(EIA)	±30ppm/°C(-55~+125°C)	0.40×0.20	18pF	±5%	16	0.22	
CL02C220JO2ANN □	COG(EIA)	±30ppm/°C(-55~+125°C)	0.40×0.20	22pF	±5%	16	0.22	
CL02C270JO2ANN □	COG(EIA)	±30ppm/°C(-55~+125°C)	0.40×0.20	27pF	±5%	16	0.22	
CL02C330JO2ANN □	COG(EIA)	±30ppm/°C(-55~+125°C)	0.40×0.20	33pF	±5%	16	0.22	
CL02C390JO2ANN □	COG(EIA)	±30ppm/°C(-55~+125°C)	0.40×0.20	39pF	±5%	16	0.22	
CL02C470JO2ANN □	COG(EIA)	±30ppm/°C(-55~+125°C)	0.40×0.20	47pF	±5%	16	0.22	

※ □ mark means packaging code. If you want to learn the code or quantity in detail, please see p 81.

Part Numbering System

General Capacitors

Ultra High Capacitors

Super Small Capacitors

High Voltage Capacitors

Camera Strobe Circuit Capacitors

Array Type Capacitors

Low ESL Capacitors

Reliability Test Condition

Premium Capacitors for Automotive Applications

Packaging Specification

Application Manual for Surface Mounting

Product Line Up (Super Small Size Capacitors)

Part Number	TC Code	Temperature Characteristics	Size L × W (mm)	Capacitance	Capacitance Tolerance	Rated Voltage (Vdc)	Thickness Max. (mm)
CL03B331KO3NNN□	X7R(EIA)	± 15 % (-55~+125℃)	0.60×0.30	0.33nF	±10%	16	0.33
CL03B102KO3NNN□	X7R(EIA)	± 15 % (-55~+125℃)	0.60×0.30	1.0nF	±10%	16	0.33
CL03A104KO3NNN□	X5R(EIA)	± 15 % (-55~+85℃)	0.60×0.30	100nF	±10%	16	0.33
CL02B101KP2NNN□	X7R(EIA)	± 15 % (-55~+125℃)	0.40×0.20	0.1nF	±10%	10	0.22
CL02B151KP2NNN□	X7R(EIA)	± 15 % (-55~+125℃)	0.40×0.20	0.15nF	±10%	10	0.22
CL02B221KP2NNN□	X7R(EIA)	± 15 % (-55~+125℃)	0.40×0.20	0.22nF	±10%	10	0.22
CL02B331KP2NNN□	X7R(EIA)	± 15 % (-55~+125℃)	0.40×0.20	0.33nF	±10%	10	0.22
CL02B471KP2NNN□	X7R(EIA)	± 15 % (-55~+125℃)	0.40×0.20	0.47nF	±10%	10	0.22
CL02B681KP2NNN□	X7R(EIA)	± 15 % (-55~+125℃)	0.40×0.20	0.68nF	±10%	10	0.22
CL02B102KP2NNN□	X7R(EIA)	± 15 % (-55~+125℃)	0.40×0.20	0.1nF	±10%	10	0.22
CL03B472KP3NNN□	X7R(EIA)	± 15 % (-55~+125℃)	0.60×0.30	4.7nF	±10%	10	0.33
CL03A103KP3NNN□	X5R(EIA)	± 15 % (-55~+85℃)	0.60×0.30	10nF	±10%	10	0.33
CL03B103KP3NNN□	X7R(EIA)	± 15 % (-55~+125℃)	0.60×0.30	10nF	±10%	10	0.33
CL03A104KP3NNN□	X5R(EIA)	± 15 % (-55~+85℃)	0.60×0.30	100nF	±10%	10	0.33
CL02C560JQ2ANN□	C0G(EIA)	±30ppm/℃(-55~+125℃)	0.40×0.20	0.056nF	±5%	6.3	0.22
CL02C680JQ2ANN□	C0G(EIA)	±30ppm/℃(-55~+125℃)	0.40×0.20	0.068nF	±5%	6.3	0.22
CL02C820JQ2ANN□	C0G(EIA)	±30ppm/℃(-55~+125℃)	0.40×0.20	0.082nF	±5%	6.3	0.22
CL02C101JQ2ANN□	C0G(EIA)	±30ppm/℃(-55~+125℃)	0.40×0.20	0.1nF	±5%	6.3	0.22
CL03B472KQ3NNN□	X7R(EIA)	± 15 % (-55~+125℃)	0.60×0.30	4.7nF	±10%	6.3	0.33
CL02A151KQ2NNN□	X5R(EIA)	± 15 % (-55~+85℃)	0.40×0.20	0.15nF	±10%	6.3	0.22
CL02A221KQ2NNN□	X5R(EIA)	± 15 % (-55~+85℃)	0.40×0.20	0.22nF	±10%	6.3	0.22
CL02A331KQ2NNN□	X5R(EIA)	± 15 % (-55~+85℃)	0.40×0.20	0.33nF	±10%	6.3	0.22
CL02A471KQ2NNN□	X5R(EIA)	± 15 % (-55~+85℃)	0.40×0.20	0.47nF	±10%	6.3	0.22
CL02A681KQ2NNN□	X5R(EIA)	± 15 % (-55~+85℃)	0.40×0.20	0.68nF	±10%	6.3	0.22
CL02A102KQ2NNN□	X5R(EIA)	± 15 % (-55~+85℃)	0.40×0.20	1.0nF	±10%	6.3	0.22
CL02A152KQ2NNN□	X5R(EIA)	± 15 % (-55~+85℃)	0.40×0.20	1.5nF	±10%	6.3	0.22
CL02A222KQ2NNN□	X5R(EIA)	± 15 % (-55~+85℃)	0.40×0.20	2.2nF	±10%	6.3	0.22
CL02A332KQ2NNN□	X5R(EIA)	± 15 % (-55~+85℃)	0.40×0.20	3.3nF	±10%	6.3	0.22
CL02A472KQ2NNN□	X5R(EIA)	± 15 % (-55~+85℃)	0.40×0.20	4.7nF	±10%	6.3	0.22
CL02A682KQ2NNN□	X5R(EIA)	± 15 % (-55~+85℃)	0.40×0.20	6.8nF	±10%	6.3	0.22
CL02A103KQ2NNN□	X5R(EIA)	± 15 % (-55~+85℃)	0.40×0.20	10nF	±10%	6.3	0.22
CL03A223KQ3NNN□	X5R(EIA)	± 15 % (-55~+85℃)	0.60×0.30	22nF	±10%	6.3	0.33
CL03A473KQ3NNN□	X5R(EIA)	± 15 % (-55~+85℃)	0.60×0.30	47nF	±10%	6.3	0.33
CL03A104KQ3NNN□	X5R(EIA)	± 15 % (-55~+85℃)	0.60×0.30	100nF	±10%	6.3	0.33
CL03A224KQ3NNN□	X5R(EIA)	± 15 % (-55~+85℃)	0.60×0.30	220nF	±10%	6.3	0.33

※ □mark means packaging code. If you want to learn the code or quantity in detail, please see p 81.

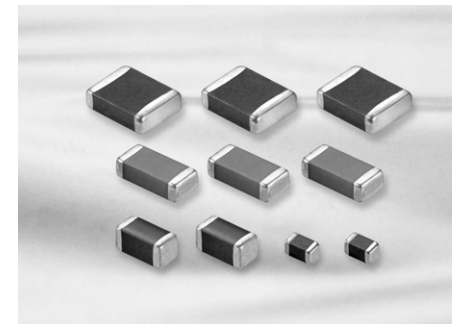

Feature

- Highly reliable performance
- Operating at high voltage level
- Wide voltage level: from 100V to 3000V
- High withstanding voltage
- Tape & reel surface mount assembly

Application

- Switching Power Circuit(SMPS)
- Lighting Ballast, LCD back lighting inverter
- DC-DC converter input filter, snubber circuit
- Phone, Fax, Modem
- Network(IEEE802.3)
 - ※ For using special purpose like Military, Medical, Aviation, Automobile device should be following a special specification.

Structure and Dimensions

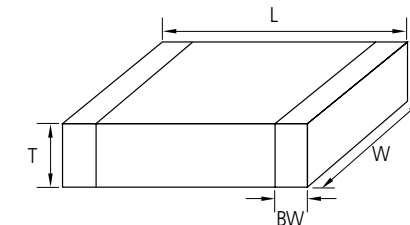

Code	EIA Code	Dimension(mm)			
		L	W	T	BW
10	0603	1.6±0.1	0.8±0.1	0.8±0.1	0.3±0.2
21	0805	2.0±0.1	1.25±0.1	1.25±0.1	0.5+0.2/-0.3
31	1206	3.2±0.2	1.6±0.2	1.6±0.2	0.5±0.3
		3.2±0.15	1.6±0.15	0.85±0.15	
32	1210	3.2±0.3	2.5±0.2	2.5±0.2	0.6±0.3
42	1808	4.5±0.4	2.0±0.2	2.0±0.2	0.8±0.3
43	1812	4.5±0.4	3.2±0.3	2.5±0.2	0.8±0.3
55	2220	5.7±0.4	5.0±0.4	2.5±0.2	1.0±0.3

Part Numbering System

General Capacitors

Ultra High Capacitors

Super Small Capacitors

High Voltage Capacitors

Camera Strobe Circuit Capacitors

Array Type Capacitors

Low ESL Capacitors

Reliability Test Condition

Premium Capacitors for Automotive Applications

Packaging Specification

Application Manual for Surface Mounting

Capacitance Table (High Voltage Capacitors)

Size	0603(10)		0805(21)		1206(31)							
	TC										COG(C)	
Rated V	100(C)	250(E)	100(C)	200(D)	250(E)	100(C)	200(D)	250(E)	500(G)	630(H)	1000(I)	2000(J)
Capacitance -pF- (part numbering code) and thickness -mm-												
0.5(0R5) ~9.1(9R1)												
10(100) ~27(270)												
33(330)												1.6 (H)
39(390)												
47(470)			0.65 (A)								1.25 (F)	
56(560)		0.80 (8)										
68(680)	0.80 (8)	0.80 (8)	0.85 (C)	0.85 (C)					1.25 (F)	1.25 (F)		
82(820) ~180(181)												100
220(221) ~390(391)						0.85 (C)					1.6 (H)	150 270
470(471)							0.85 (C)	0.85 (C)				
560(561)												
680(681)			0.85 (C)	1.25 (F)								
820(821)												
1000(102)							1.25 (F)	1.25 (F)				
1200(122)					1.25 (F)							
1500(152)									1.6 (H)	1.6 (H)		
1800(182)												
2200(222)			1.25 (F)				1.6 (H)					
2700(272)												
3300(332)						1.25 (F)						
3900(392)								1.6 (H)				
4700(472)												
5600(562)												
6800(682)												
8200(822)						1.6 (H)						
10000(103)												
15000(153)												
18000(183)												

Capacitance Table (High Voltage Capacitors)

Size	1210(32)							1808(42)		
	TC									COG(C)
Rated V	100(C)	200(D)	250(E)	500(G)	630(H)	1000(I)	2000(J)	2000(J)	3000(K)	
Capacitance -pF- (part numbering code) and thickness -mm-										
10(100)										
12(120)										
15(150)										
18(180)										
22(220)										
27(270)										
33(330)										
39(390)										
47(470)										
56(560)										
68(680)										
82(820)								1.25 (F)		
100(101)										
120(121)										
150(151)										
180(181)										
220(221)								1.6 (H)	1.6 (H)	
270(271)								2.0 (I)		
330(331)										
390(391)								2.5 (U)		
470(471)										
560(561)								1.6 (H)		
680(681)					1.25 (F)	1.25 (F)		2.0 (I)		
820(821)								2.5 (U)		
1000(102)										
1200(122)										
1500(152)					1.6 (H)	1.6 (H)				
1800(182)					2.0 (I)	2.0 (I)				
2200(222)										
2700(272)										
3300(332)			1.25 (F)							
3900(392)			1.6 (H)							
4700(472)			2.0 (I)							
5600(562)	1.25 (F)									
6800(682)		1.25 (F)	1.6 (H)							
8200(822)		2.5 (U)								
10000(103)	1.6 (H)									
12000(123)	2.0 (I)									
15000(153)						2.5 (U)				
18000(183)										
27000(273)										
39000(393)	2.5 (U)									
47000(473)										
56000(563)										

Part Numbering System

General Capacitors

Ultra High Capacitors

Super Small Capacitors

High Voltage Capacitors

Camera Strobe Circuit Capacitors

Array Type Capacitors

Low ESL Capacitors

Reliability Test Condition

Premium Capacitors for Automotive Applications

Packaging Specification

Application Manual for Surface Mounting

Capacitance Table (High Voltage Capacitors)

Size	1812(43)						2220(55)						
	COG(C)												
TC													
Rated V	100(C)	200(D)	250(E)	500(G)	630(H)	1000(I)	2000(J)	3000(K)	250(E)	500(G)	630(H)	1000(I)	3000(K)
Capacitance -pF- (part numbering code) and thickness -mm-													
47(470)							1.25 (F)						
82(820)													
100(101)													
120(121)													
150(151)													
180(181)													
220(221)													
270(271)													
390(391)													
470(471)													
680(681)													
820(821)													
1000(102)													
1200(122)													
1500(152)													
1800(182)													
2200(222)													
2700(272)													
3300(332)													
3600(362)													
4700(472)													
5600(562)													
6800(682)													
8200(822)													
10000(103)													
12000(123)													
15000(153)													
18000(183)													
22000(223)													
27000(273)													
33000(333)													
39000(393)													
47000(473)													
68000(683)													

Legend: :X7R(B) :X5R(A) :Y5V(F) :COG(C) :X6S(X)

Capacitance Table (High Voltage Capacitors)

Size	0603(10)	0805(21)			1206(31)							
	X7R(B)											
TC												
Rated V	100(C)	100(C)	200(D)	250(E)	100(C)	200(D)	250(E)	500(G)	630(H)	1000(I)	2000(J)	
Capacitance -pF- (part numbering code) and thickness -mm-												
220(221)												
330(331)												
470(471)												
680(681)												
1000(102)												
1500(152)												
2200(222)												
3300(332)												
4700(472)												
6800(682)												
10000(103)												
15000(153)												
22000(223)												
33000(333)												
47000(473)												
68000(683)												
100000(104)												
150000(154)												
220000(224)												
1000000(105)												

Size	1210(32)						1808(42)
	X7R(B)						
TC							
Rated V	100(C)	250(E)	500(G)	630(H)	1000(I)	2000(J)	2000(J)
Capacitance -pF- (part numbering code) and thickness -mm-							
470(471)							
1000(102)							
2200(222)							
3300(332)							
4700(472)							
6800(682)							
10000(103)							
15000(153)							
22000(223)							
33000(333)							
47000(473)							
68000(683)							
100000(104)							
150000(154)							
220000(224)							
330000(334)							
470000(474)							
680000(684)							
1000000(105)							

Legend: :X7R(B) :X5R(A) :Y5V(F) :COG(C) :X6S(X)

Part Numbering System

General Capacitors

Ultra High Capacitors

Super Small Capacitors

High Voltage Capacitors

Camera Strobe Circuit Capacitors

Array Type Capacitors

Low ESL Capacitors

Reliability Test Condition

Premium Capacitors for Automotive Applications

Packaging Specification

Application Manual for Surface Mounting

Capacitance Table (High Voltage Capacitors)

Size TC Rated V	1812(43)						2220(55)					
	X7R(B)											
	100(C)	200(D)	250(E)	500(G)	1000(I)	2000(J)	100(C)	250(E)	500(G)	1000(I)	2000(J)	
Capacitance -pF- (part numbering code) and thickness -mm-												
1000(102)												
1500(152)												
1800(182)						1.25 (F)						
2700(272)												
3300(332)												
3900(392)												
4700(472)					1.25 (F)							
5600(562)											1.6 (H)	
6800(682)												
8200(822)												
10000(103)												
12000(123)						1.6 (H)						
15000(153)												
18000(183)												
22000(223)				1.25 (F)								
27000(273)					2.5 (J)							
33000(333)												
39000(393)												
47000(473)										2.0 (I)		
56000(563)												
68000(683)		1.25 (F)		1.6 (H)								
82000(823)				2.0 (I)								
100000(104)												
120000(124)												
150000(154)												
180000(184)	1.25 (F)											
220000(224)			2.5 (J)						2.5 (J)			
270000(274)												
330000(334)												
470000(474)	1.6 (H)											
560000(564)	2.0 (I)								2.5 (J)			
680000(684)												
820000(824)	2.5 (J)							1.6 (H)				
1000000(105)												
1500000(155)								2.0 (I)				
2200000(225)												
3300000(335)								2.5 (J)				
4700000(475)												

■:X7R(B) ■:X5R(A) ■:Y5V(F) ■:COG(C) ■:X6S(X)

Product Line Up (High Voltage Capacitors)

Part Number	TC Code	Temperature Characteristics	Rated Voltage (Vdc)	Size L×W (mm)	Capacitance	Capacitance Tolerance	Thickness Max. (mm)
CL42C100JKFNND	COG(EIA)	±30ppm/°C(-55~+125°C)	3000	4.50X2.00	10pF	±5%	1.35
CL31C220JJHNND	COG(EIA)	±30ppm/°C(-55~+125°C)	2000	3.20X1.60	22pF	±5%	1.80
CL31C470JJHNND	COG(EIA)	±30ppm/°C(-55~+125°C)	2000	3.20X1.60	47pF	±5%	1.80
CL32C101JJFNND	COG(EIA)	±30ppm/°C(-55~+125°C)	2000	3.20X2.50	100pF	±5%	1.35
CL31C680JIFNND	COG(EIA)	±30ppm/°C(-55~+125°C)	1000	3.20X1.60	68pF	±5%	1.35
CL31C101JIFNND	COG(EIA)	±30ppm/°C(-55~+125°C)	1000	3.20X1.60	100pF	±5%	1.35
CL43C102JIHNND	COG(EIA)	±30ppm/°C(-55~+125°C)	1000	4.50X3.20	1.0nF	±5%	1.80
CL43C122JIIHNND	COG(EIA)	±30ppm/°C(-55~+125°C)	1000	4.50X3.20	1.2nF	±5%	2.20
CL43C182JIIHNND	COG(EIA)	±30ppm/°C(-55~+125°C)	1000	4.50X3.20	1.8nF	±5%	2.80
CL31C470JHFNND	COG(EIA)	±30ppm/°C(-55~+125°C)	630	3.20X1.60	47pF	±5%	1.35
CL31C680JHFNND	COG(EIA)	±30ppm/°C(-55~+125°C)	630	3.20X1.60	68pF	±5%	1.35
CL31C101JHFNND	COG(EIA)	±30ppm/°C(-55~+125°C)	630	3.20X1.60	100pF	±5%	1.35
CL31C150JGFNND	COG(EIA)	±30ppm/°C(-55~+125°C)	500	3.20X1.60	15pF	±5%	1.35
CL31C180JGFNND	COG(EIA)	±30ppm/°C(-55~+125°C)	500	3.20X1.60	18pF	±5%	1.35
CL31C220JGFNND	COG(EIA)	±30ppm/°C(-55~+125°C)	500	3.20X1.60	22pF	±5%	1.35
CL31C270JGFNND	COG(EIA)	±30ppm/°C(-55~+125°C)	500	3.20X1.60	27pF	±5%	1.35
CL31C330JGFNND	COG(EIA)	±30ppm/°C(-55~+125°C)	500	3.20X1.60	33pF	±5%	1.35
CL31C390JGFNND	COG(EIA)	±30ppm/°C(-55~+125°C)	500	3.20X1.60	39pF	±5%	1.35
CL31C470JGFNND	COG(EIA)	±30ppm/°C(-55~+125°C)	500	3.20X1.60	47pF	±5%	1.35
CL31C560JGFNND	COG(EIA)	±30ppm/°C(-55~+125°C)	500	3.20X1.60	56pF	±5%	1.35
CL31C680JGFNND	COG(EIA)	±30ppm/°C(-55~+125°C)	500	3.20X1.60	68pF	±5%	1.35
CL31C820JGFNND	COG(EIA)	±30ppm/°C(-55~+125°C)	500	3.20X1.60	82pF	±5%	1.35
CL31C101JGFNND	COG(EIA)	±30ppm/°C(-55~+125°C)	500	3.20X1.60	100pF	±5%	1.35
CL31C121JGFNND	COG(EIA)	±30ppm/°C(-55~+125°C)	500	3.20X1.60	120pF	±5%	1.35
CL31C151JGFNND	COG(EIA)	±30ppm/°C(-55~+125°C)	500	3.20X1.60	150pF	±5%	1.35
CL31C181JGFNND	COG(EIA)	±30ppm/°C(-55~+125°C)	500	3.20X1.60	180pF	±5%	1.35
CL31C221JGFNND	COG(EIA)	±30ppm/°C(-55~+125°C)	500	3.20X1.60	220pF	±5%	1.35
CL31C271JGFNND	COG(EIA)	±30ppm/°C(-55~+125°C)	500	3.20X1.60	270pF	±5%	1.35
CL31C331JGFNND	COG(EIA)	±30ppm/°C(-55~+125°C)	500	3.20X1.60	330pF	±5%	1.35
CL31C471JGFNND	COG(EIA)	±30ppm/°C(-55~+125°C)	500	3.20X1.60	470pF	±5%	1.35
CL31C561JGFNND	COG(EIA)	±30ppm/°C(-55~+125°C)	500	3.20X1.60	560pF	±5%	1.35
CL31C681JGFNND	COG(EIA)	±30ppm/°C(-55~+125°C)	500	3.20X1.60	680pF	±5%	1.80
CL31C102JGHNND	COG(EIA)	±30ppm/°C(-55~+125°C)	500	3.20X1.60	1.0nF	±5%	1.80
CL32C103JGNND	COG(EIA)	±30ppm/°C(-55~+125°C)	500	3.20X2.50	10nF	±5%	2.70
CL43C223JGNND	COG(EIA)	±30ppm/°C(-55~+125°C)	500	4.50X3.20	22nF	±5%	2.70
CL21C101JECNND	COG(EIA)	±30ppm/°C(-55~+125°C)	250	2.00X1.25	100pF	±5%	1.00
CL21C150JDCNND	COG(EIA)	±30ppm/°C(-55~+125°C)	200	2.00X1.25	15pF	±5%	1.00

* □ mark means packaging code. If you want to learn the code or quantity in detail, please see p 81.

Part Numbering System

General Capacitors

Ultra High Capacitors

Super Small Capacitors

High Voltage Capacitors

Camera Strobe Circuit Capacitors

Array Type Capacitors

Low ESL Capacitors

Reliability Test Condition

Premium Capacitors for Automotive Applications

Packaging Specification

Application Manual for Surface Mounting

Product Line Up (High Voltage Capacitors)

Part Number	TC Code	Temperature Characteristics	Rated Voltage (Vdc)	Size L×W (mm)	Capacitance	Capacitance Tolerance	Thickness Max. (mm)
CL21C180JDCNNN □	COG(EIA)	±30ppm/°C(-55~+125°C)	200	2.00X1.25	18pF	±5%	1.00
CL21C330JDCNNN □	COG(EIA)	±30ppm/°C(-55~+125°C)	200	2.00X1.25	33pF	±5%	1.00
CL21C390JDCNNN □	COG(EIA)	±30ppm/°C(-55~+125°C)	200	2.00X1.25	39pF	±5%	1.00
CL21C470JDCNNN □	COG(EIA)	±30ppm/°C(-55~+125°C)	200	2.00X1.25	47pF	±5%	1.00
CL21C560JDCNNN □	COG(EIA)	±30ppm/°C(-55~+125°C)	200	2.00X1.25	56pF	±5%	1.00
CL21C680JDCNNN □	COG(EIA)	±30ppm/°C(-55~+125°C)	200	2.00X1.25	68pF	±5%	1.00
CL21C101JDCNNN □	COG(EIA)	±30ppm/°C(-55~+125°C)	200	2.00X1.25	100pF	±5%	1.00
CL21C121JDCNNN □	COG(EIA)	±30ppm/°C(-55~+125°C)	200	2.00X1.25	120pF	±5%	1.00
CL21C221JDCNNN □	COG(EIA)	±30ppm/°C(-55~+125°C)	200	2.00X1.25	220pF	±5%	1.00
CL21C102JDFNND □	COG(EIA)	±30ppm/°C(-55~+125°C)	200	2.00X1.25	1.0nF	±5%	1.35
CL10C100JC8NNN □	COG(EIA)	±30ppm/°C(-55~+125°C)	100	1.60X0.80	10pF	±5%	0.90
CL21C100JCANNN □	COG(EIA)	±30ppm/°C(-55~+125°C)	100	2.00X1.25	10pF	±5%	0.75
CL21C120JCANNN □	COG(EIA)	±30ppm/°C(-55~+125°C)	100	2.00X1.25	12pF	±5%	0.75
CL10C150JC8NNN □	COG(EIA)	±30ppm/°C(-55~+125°C)	100	1.60X0.80	15pF	±5%	0.90
CL21C150JCANNN □	COG(EIA)	±30ppm/°C(-55~+125°C)	100	2.00X1.25	15pF	±5%	0.75
CL21C180JCANNN □	COG(EIA)	±30ppm/°C(-55~+125°C)	100	2.00X1.25	18pF	±5%	0.75
CL21C220JCANNN □	COG(EIA)	±30ppm/°C(-55~+125°C)	100	2.00X1.25	22pF	±5%	0.75
CL21C270JCANNN □	COG(EIA)	±30ppm/°C(-55~+125°C)	100	2.00X1.25	27pF	±5%	0.75
CL21C330JCANNN □	COG(EIA)	±30ppm/°C(-55~+125°C)	100	2.00X1.25	33pF	±5%	0.75
CL10C330JC8NNN □	COG(EIA)	±30ppm/°C(-55~+125°C)	100	1.60X0.80	33pF	±5%	0.90
CL10C390JC8NNN □	COG(EIA)	±30ppm/°C(-55~+125°C)	100	1.60X0.80	39pF	±5%	0.90
CL10C470JC8NNN □	COG(EIA)	±30ppm/°C(-55~+125°C)	100	1.60X0.80	47pF	±5%	0.90
CL21C470JCANNN □	COG(EIA)	±30ppm/°C(-55~+125°C)	100	2.00X1.25	47pF	±5%	0.75
CL21C560JCCNNN □	COG(EIA)	±30ppm/°C(-55~+125°C)	100	2.00X1.25	47pF	±5%	0.75
CL21C680JCANNN □	COG(EIA)	±30ppm/°C(-55~+125°C)	100	2.00X1.25	68pF	±5%	0.75
CL31C680JCCNNN □	COG(EIA)	±30ppm/°C(-55~+125°C)	100	3.20X1.60	68pF	±5%	1.00
CL21C820JCCNNN □	COG(EIA)	±30ppm/°C(-55~+125°C)	100	3.20X1.60	82pF	±5%	1.00
CL10C101JC8NNN □	COG(EIA)	±30ppm/°C(-55~+125°C)	100	1.60X0.80	100pF	±5%	0.90
CL21C101JCANNN □	COG(EIA)	±30ppm/°C(-55~+125°C)	100	2.00X1.25	100pF	±5%	0.75
CL10C121JC8NNN □	COG(EIA)	±30ppm/°C(-55~+125°C)	100	1.60X0.80	120pF	±5%	0.90
CL10C151JC8NNN □	COG(EIA)	±30ppm/°C(-55~+125°C)	100	1.60X0.80	150pF	±5%	0.90
CL21C151JCANNN □	COG(EIA)	±30ppm/°C(-55~+125°C)	100	2.00X1.25	150pF	±5%	0.75
CL21C221JCANNN □	COG(EIA)	±30ppm/°C(-55~+125°C)	100	2.00X1.25	220pF	±5%	0.75
CL31C271JCCNNN □	COG(EIA)	±30ppm/°C(-55~+125°C)	100	3.20X1.60	270pF	±5%	1.00
CL21C331JCANNN □	COG(EIA)	±30ppm/°C(-55~+125°C)	100	2.00X1.25	330pF	±5%	0.75

※ □ mark means packaging code. If you want to learn the code or quantity in detail, please see p 81.

Product Line Up (High Voltage Capacitors)

Part Number	TC Code	Temperature Characteristics	Rated Voltage (Vdc)	Size L×W (mm)	Capacitance	Capacitance Tolerance	Thickness Max. (mm)
CL10C331JC8NNN □	COG(EIA)	±30ppm/°C(-55~+125°C)	100	1.60X0.80	330pF	±5%	0.90
CL31C391JCCNNN □	COG(EIA)	±30ppm/°C(-55~+125°C)	100	3.20X1.60	390pF	±5%	1.00
CL10C471JC8NNN □	COG(EIA)	±30ppm/°C(-55~+125°C)	100	1.60X0.80	470pF	±5%	0.90
CL21C471JCCNNN □	COG(EIA)	±30ppm/°C(-55~+125°C)	100	2.00X1.25	470pF	±5%	1.00
CL21C561JCCNNN □	COG(EIA)	±30ppm/°C(-55~+125°C)	100	2.00X1.25	560pF	±5%	1.00
CL31C561JCCNNN □	COG(EIA)	±30ppm/°C(-55~+125°C)	100	3.20X1.60	560pF	±5%	1.00
CL21C681JCCNNN □	COG(EIA)	±30ppm/°C(-55~+125°C)	100	2.00X1.25	680pF	±5%	1.00
CL21C102JCFNND □	COG(EIA)	±30ppm/°C(-55~+125°C)	100	2.00X1.25	1.0nF	±5%	1.35
CL31C102JCCNNN □	COG(EIA)	±30ppm/°C(-55~+125°C)	100	3.20X1.60	1.0nF	±5%	1.00
CL31C152JCCNNN □	COG(EIA)	±30ppm/°C(-55~+125°C)	100	3.20X1.60	1.5nF	±5%	1.00
CL31C222JCCNNN □	COG(EIA)	±30ppm/°C(-55~+125°C)	100	3.20X1.60	2.2nF	±5%	1.00
CL31C392JCHNND □	COG(EIA)	±30ppm/°C(-55~+125°C)	100	3.20X1.60	3.9nF	±5%	1.80

Part Number	TC Code	Temperature Characteristics	Rated Voltage (Vdc)	Size L×W (mm)	Capacitance	Capacitance Tolerance	Thickness Max. (mm)
CL31B102KJHNNND □	X7R(EIA)	±15%(-55~+125°C)	2000	3.20×1.60	1.0nF	±10%	1.80
CL32B102KJFNND □	X7R(EIA)	±15%(-55~+125°C)	2000	3.20×2.50	1.0nF	±10%	1.35
CL43B102KJFNND □	X7R(EIA)	±15%(-55~+125°C)	2000	4.50×3.20	1.0nF	±10%	1.35
CL43B152KJFNND □	X7R(EIA)	±15%(-55~+125°C)	2000	4.50×3.20	1.5nF	±10%	1.35
CL31B102K1FNND □	X7R(EIA)	±15%(-55~+125°C)	1000	3.20×1.60	1.0nF	±10%	1.35
CL31B222K1FNND □	X7R(EIA)	±15%(-55~+125°C)	1000	3.20×1.60	2.2nF	±10%	1.35
CL43B222K1FNND □	X7R(EIA)	±15%(-55~+125°C)	1000	4.50×3.20	2.2nF	±10%	1.35
CL43B103K1FNND □	X7R(EIA)	±15%(-55~+125°C)	1000	4.50×3.20	10nF	±10%	1.35
CL31B102KHFNND □	X7R(EIA)	±15%(-55~+125°C)	630	3.20×1.60	1.0nF	±10%	1.35
CL32B472KHFNND □	X7R(EIA)	±15%(-55~+125°C)	630	3.20×2.50	4.7nF	±10%	1.35
CL31B103KHFNND □	X7R(EIA)	±15%(-55~+125°C)	630	3.20×1.60	10nF	±10%	1.35
CL32B333KHNNND □	X7R(EIA)	±15%(-55~+125°C)	630	3.20×2.50	33nF	±10%	1.80
CL32B473KHNNND □	X7R(EIA)	±15%(-55~+125°C)	630	3.20×2.50	47nF	±10%	1.80
CL31B221KGFNND □	X7R(EIA)	±15%(-55~+125°C)	500	3.20×1.60	0.22nF	±10%	1.35
CL31B471KGFNND □	X7R(EIA)	±15%(-55~+125°C)	500	3.20×1.60	0.47nF	±10%	1.35
CL31B102KGFNND □	X7R(EIA)	±15%(-55~+125°C)	500	3.20×1.60	1.0nF	±10%	1.35
CL31B152KGFNND □	X7R(EIA)	±15%(-55~+125°C)	500	3.20×1.60	1.5nF	±10%	1.35

※ □ mark means packaging code. If you want to learn the code or quantity in detail, please see p 81.

Part Numbering System

General Capacitors

Ultra High Capacitors

Super Small Capacitors

High Voltage Capacitors

Camera Strobe Circuit Capacitors

Array Type Capacitors

Low ESL Capacitors

Reliability Test Condition

Premium Capacitors for Automotive Applications

Packaging Specification

Application Manual for Surface Mounting

Product Line Up (High Voltage Capacitors)

Part Number	TC Code	Temperature Characteristics	Rated Voltage (Vdc)	Size L×W (mm)	Capacitance	Capacitance Tolerance	Thickness Max. (mm)
CL31B222KGFNNN □	X7R(EIA)	±15%(-55~+125℃)	500	3.20×1.60	2.2nF	±10%	1.35
CL31B332KGFNNN □	X7R(EIA)	±15%(-55~+125℃)	500	3.20×1.60	3.3nF	±10%	1.35
CL31B472KGFNNN □	X7R(EIA)	±15%(-55~+125℃)	500	3.20×1.60	4.7nF	±10%	1.35
CL31B682KGFNNN □	X7R(EIA)	±15%(-55~+125℃)	500	3.20×1.60	6.8nF	±10%	1.35
CL31B103KGFNNN □	X7R(EIA)	±15%(-55~+125℃)	500	3.20×1.60	10nF	±10%	1.35
CL32B153KGFNNN □	X7R(EIA)	±15%(-55~+125℃)	500	3.20×2.50	15nF	±10%	1.35
CL32B223KGFNNN □	X7R(EIA)	±15%(-55~+125℃)	500	3.20×2.50	22nF	±10%	1.35
CL43B473KGFNNN □	X7R(EIA)	±15%(-55~+125℃)	500	4.50×3.20	47nF	±10%	1.35
CL43B104KGINNN □	X7R(EIA)	±15%(-55~+125℃)	500	4.50×3.20	100nF	±10%	2.20
CL21B153KEFNNN □	X7R(EIA)	±15%(-55~+125℃)	250	2.00×1.25	15nF	±10%	1.35
CL31B473KEHNNN □	X7R(EIA)	±15%(-55~+125℃)	250	3.20×1.60	47nF	±10%	1.80
CL32B104KEJNNN □	X7R(EIA)	±15%(-55~+125℃)	250	3.20×2.50	100nF	±10%	2.80
CL43B474KEJNNN □	X7R(EIA)	±15%(-55~+125℃)	250	4.50×3.20	470nF	±10%	2.80
CL21B221KDCNNN □	X7R(EIA)	±15%(-55~+125℃)	200	2.00×1.25	0.22nF	±10%	1.00
CL21B331KDCNNN □	X7R(EIA)	±15%(-55~+125℃)	200	2.00×1.25	0.33nF	±10%	1.00
CL31B471KDCNNN □	X7R(EIA)	±15%(-55~+125℃)	200	3.20×1.60	0.47nF	±10%	1.00
CL21B102KDCNNN □	X7R(EIA)	±15%(-55~+125℃)	200	2.00×1.25	1.0nF	±10%	1.00
CL21B222KDCNNN □	X7R(EIA)	±15%(-55~+125℃)	200	2.00×1.25	2.2nF	±10%	1.00
CL31B222KDCNNN □	X7R(EIA)	±15%(-55~+125℃)	200	3.20×1.60	2.2nF	±10%	1.00
CL21B472KDCNNN □	X7R(EIA)	±15%(-55~+125℃)	200	2.00×1.25	4.7nF	±10%	1.00
CL31B472KDCNNN □	X7R(EIA)	±15%(-55~+125℃)	200	3.20×1.60	4.7nF	±10%	1.00
CL21B103KDCNNN □	X7R(EIA)	±15%(-55~+125℃)	200	2.00×1.25	10nF	±10%	1.00
CL31B153KDCNNN □	X7R(EIA)	±15%(-55~+125℃)	200	3.20×1.60	15nF	±10%	1.00
CL31B223KDCNNN □	X7R(EIA)	±15%(-55~+125℃)	200	3.20×1.60	22nF	±10%	1.00
CL31B333KDFNNN □	X7R(EIA)	±15%(-55~+125℃)	200	3.20×1.60	33nF	±10%	1.35
CL31B473KDFNNN □	X7R(EIA)	±15%(-55~+125℃)	200	3.20×1.60	47nF	±10%	1.35
CL32B473KDHNNN □	X7R(EIA)	±15%(-55~+125℃)	200	3.20×2.50	47nF	±10%	1.80
CL31B104KDHNNN □	X7R(EIA)	±15%(-55~+125℃)	200	3.20×1.60	100nF	±10%	1.80
CL43B104KDFNNN □	X7R(EIA)	±15%(-55~+125℃)	200	4.50×3.20	100nF	±10%	1.35
CL21B221KCANNN □	X7R(EIA)	±15%(-55~+125℃)	100	2.00×1.25	0.22nF	±10%	0.75
CL21B471KCANNN □	X7R(EIA)	±15%(-55~+125℃)	100	2.00×1.25	0.47nF	±10%	0.75
CL10B102KC8NNN □	X7R(EIA)	±15%(-55~+125℃)	100	1.60×0.80	1.0nF	±10%	0.90
CL21B102KCANNN □	X7R(EIA)	±15%(-55~+125℃)	100	2.00×1.25	1.0nF	±10%	0.75
CL21B222KCANNN □	X7R(EIA)	±15%(-55~+125℃)	100	2.00×1.25	2.2nF	±10%	0.75
CL21B332KCANNN □	X7R(EIA)	±15%(-55~+125℃)	100	2.00×1.25	3.3nF	±10%	0.75

※ □ mark means packaging code. If you want to learn the code or quantity in detail, please see p 81.

Product Line Up (High Voltage Capacitors)

Part Number	TC Code	Temperature Characteristics	Rated Voltage (Vdc)	Size L×W (mm)	Capacitance	Capacitance Tolerance	Thickness Max. (mm)
CL10B472KC8NNN □	X7R(EIA)	±15%(-55~+125℃)	100	1.60×0.80	4.7nF	±10%	0.90
CL21B472KCANNN □	X7R(EIA)	±15%(-55~+125℃)	100	2.00×1.25	4.7nF	±10%	0.75
CL21B682KCANNN □	X7R(EIA)	±15%(-55~+125℃)	100	2.00×1.25	6.8nF	±10%	0.75
CL10B103KC8NNN □	X7R(EIA)	±15%(-55~+125℃)	100	1.60×0.80	10nF	±10%	0.90
CL21B103KCANNN □	X7R(EIA)	±15%(-55~+125℃)	100	2.00×1.25	10nF	±10%	0.75
CL32B103KCFNNN □	X7R(EIA)	±15%(-55~+125℃)	100	3.20×2.50	10nF	±10%	1.35
CL21B153KCCNNN □	X7R(EIA)	±15%(-55~+125℃)	100	2.00×1.25	15nF	±10%	1.00
CL31B153KCCNNN □	X7R(EIA)	±15%(-55~+125℃)	100	3.20×1.60	15nF	±10%	1.00
CL21B223KCFNNN □	X7R(EIA)	±15%(-55~+125℃)	100	2.00×1.50	22nF	±10%	1.35
CL31B223KCCNNN □	X7R(EIA)	±15%(-55~+125℃)	100	3.20×1.60	22nF	±10%	1.00
CL31B333KCCNNN □	X7R(EIA)	±15%(-55~+125℃)	100	3.20×1.60	33nF	±10%	1.00
CL21B473KCFNNN □	X7R(EIA)	±15%(-55~+125℃)	100	2.00×1.25	47nF	±10%	1.35
CL31B473KCCNNN □	X7R(EIA)	±15%(-55~+125℃)	100	3.20×1.60	47nF	±10%	1.00
CL31B104KCFNNN □	X7R(EIA)	±15%(-55~+125℃)	100	3.20×1.60	100nF	±10%	1.35
CL31B154KCHNNN □	X7R(EIA)	±15%(-55~+125℃)	100	3.20×1.60	150nF	±10%	1.80
CL32B154KCFNNN □	X7R(EIA)	±15%(-55~+125℃)	100	3.20×2.50	150nF	±10%	1.35
CL32B224KCHNNN □	X7R(EIA)	±15%(-55~+125℃)	100	3.20×2.50	220nF	±10%	1.80
CL43B224KCFNNN □	X7R(EIA)	±15%(-55~+125℃)	100	4.50×3.20	220nF	±10%	1.35
CL32B334KCHNNN □	X7R(EIA)	±15%(-55~+125℃)	100	3.20×2.50	330nF	±10%	1.80
CL43B334KCFNNN □	X7R(EIA)	±15%(-55~+125℃)	100	4.50×3.20	330nF	±10%	1.35
CL32B474KCHNNN □	X7R(EIA)	±15%(-55~+125℃)	100	3.20×2.50	470nF	±10%	2.20
CL43B474KCHNNN □	X7R(EIA)	±15%(-55~+125℃)	100	4.50×3.20	470nF	±10%	1.80
CL31B105KCHNNN □	X7R(EIA)	±15%(-55~+125℃)	100	3.20×1.60	1.0μF	±10%	1.80
CL32B105KCFNNN □	X7R(EIA)	±15%(-55~+125℃)	100	3.20×2.50	1.0μF	±10%	2.80
CL43B105KCFNNN □	X7R(EIA)	±15%(-55~+125℃)	100	4.50×3.20	1.0μF	±10%	2.80
CL55B105KCHNNN □	X7R(EIA)	±15%(-55~+125℃)	100	5.70×5.00	1.0μF	±10%	1.80

※ □ mark means packaging code. If you want to learn the code or quantity in detail, please see p 81.

- Part Numbering System
- General Capacitors
- Ultra High Capacitors
- Super Small Capacitors
- High Voltage Capacitors
- Camera Strobe Circuit Capacitors
- Array Type Capacitors
- Low ESL Capacitors
- Reliability Test Condition
- Premium Capacitors for Automotive Applications
- Packaging Specification
- Application Manual for Surface Mounting

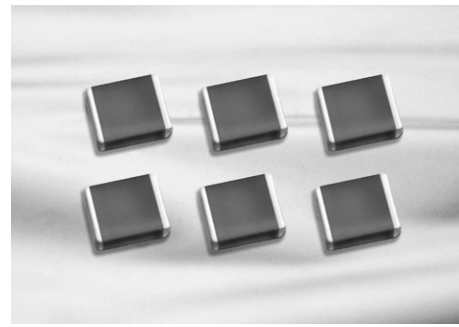

Feature

- Suitable for the trigger of the flash circuit
- Highly reliable performance
- Superior in bias characteristics
- Soft termination with a Ni/Sn plated overcoat

Application

- Strobe Circuit

Structure and Dimension

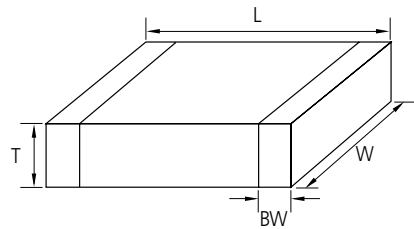

Code	EIA Code	Dimension(mm)			
		L	W	T	BW
31	1206	3.20 ± 0.20	1.60 ± 0.20	0.85 (± 0.15)	0.50 ± 0.3/-0.3
				1.10 (± 0.15)	
				1.60 (± 0.20)	

Capacitance Table (Camera Strobe Circuit Capacitors)

Size	1206(31)
TC	X7R(B)
Rated V	350(F)
Capacitance (Capacitance part numbering code) and T (mm) Dimension (T Dimension part numbering code)	
10(103)	
15(153)	0.85 (C)
22(223)	
33(333)	1.10 (E)
47(473)	1.60 (H)
68(683)	
100(104)	

■ :X7R(B)

Product Line Up (Camera Strobe Circuit Capacitors)

Part Number	TC Code	Temperature Characteristics	Rated Voltage (Vdc)	Size L × W (mm)	Capacitance	Capacitance Tolerance	Thickness Max. (mm)
CL31B103KFCSNN □	X7R(EIA)	± 15% (-55~+125℃)	350	3.20 × 1.60	10nF	± 10%	1.00
CL31B153KFCSNN □	X7R(EIA)	± 15% (-55~+125℃)	350	3.20 × 1.60	15nF	± 10%	1.00
CL31B223KFCSNN □	X7R(EIA)	± 15% (-55~+125℃)	350	3.20 × 1.60	22nF	± 10%	1.00
CL31B333KFESNN □	X7R(EIA)	± 15% (-55~+125℃)	350	3.20 × 1.60	33nF	± 10%	1.25
CL31B473KFHSNN □	X7R(EIA)	± 15% (-55~+125℃)	350	3.20 × 1.60	47nF	± 10%	1.80

Part Numbering System

General Capacitors

Ultra High Capacitors

Super Small Capacitors

High Voltage Capacitors

Camera Strobe Circuit Capacitors

Array Type Capacitors

Low ESL Capacitors

Reliability Test Condition

Premium Capacitors for Automotive Applications

Packaging Specification

Application Manual for Surface Mounting

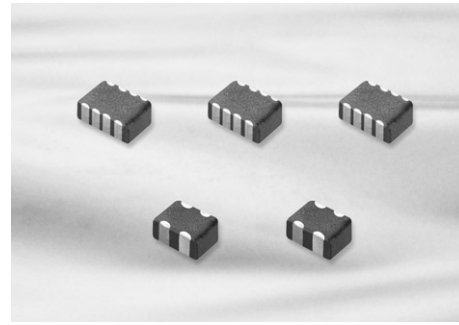

Feature

- Reduction in required space (more than 50%)
- Reduction in cost and time for replacement of PCB
- Reduction in amount of solder joints
- Easier PCB design
- Reduced waste from tape and reel packaging process
- It protect EMI bypassing digital signal line nose

Application

- A bypass for digital and analog signal line noise generated by telecommunication equipment and other common electronic circuits
- ※ For using special purpose like Military, Medical, Aviation, Automobile device should be following a special specification.

Structure and Dimensions

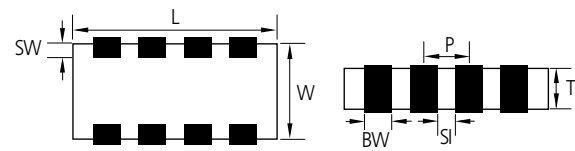

Pd MLCC (12th code in part number of Pd MLCC = A)

- Class I type
Capacitance < 10pF (Class I, 0402, 0603, 0805 case size)
Capacitance > 18pF (Class I, 1206 case size)
- Except the Capacitance range mentioned as above.
All other the Capacitance range is using Ni inner electrode for Class I,
Class II type (12th code in part number of Ni MLCC=N)

Code	EIA Code	Dimension(mm)					
		L	W	T	BW	SW	P
A	0504	1.37±0.15	1.0±0.15	0.60±0.06 0.80±0.08	0.36±0.1	0.2±0.1	0.64±0.1
A	0805	2.0±0.15	1.25±0.15	0.85±0.1	0.5±0.2	0.25±0.15	1.0±0.1
B	0805	2.0±0.15	1.25±0.15	0.85±0.1	0.25±0.1	0.25±0.15	0.5±0.1
B	1206	3.2±0.15	1.6±0.15	0.85±0.15	0.4±0.2	0.3±0.15	0.8±0.2

Structure and Control Code

A : ARRAY(2-element)

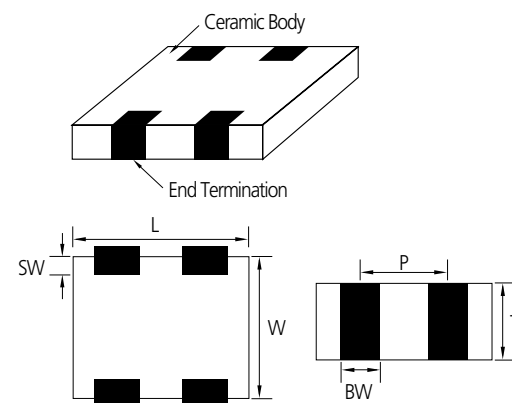

B : ARRAY(4-element)

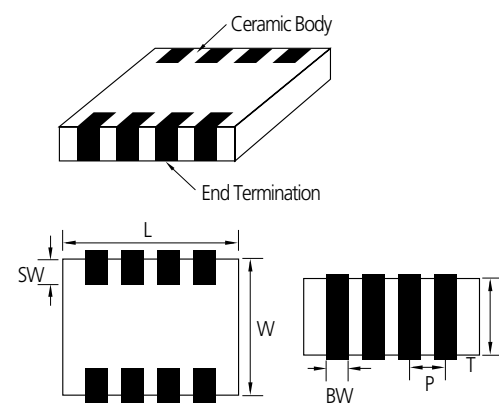

Capacitance Table

Size	0504(14)				0805(21)					1206(31)				
	TC	COG(C)		X7R(B)/X5R(A)		X5R(A) / X7R(B)			COG(C)	X7R(B)		Y5V(F)		
Element	2 Element	2 Element		2 Element		4 Element			4 Element	4 Element		4 Element		
Rated V	25(A)	10(P)	16(O)	25(A)	10(P)	16(O)	10(P)	16(O)	50(B)	50(B)	25(A)	50(B)	25(A)	50(B)
Capacitance -pF- (part numbering code) and T Dimension -mm- (part numbering code)														
10(100)														
12(120)														
15(150)														
18(180)														
22(221)		0.60 (6)												
27(270)														
33(330)														
47(470)														
56(560)														
68(680)														
82(820)														
100(101)														
120(121)														
150(151)														
180(181)														
220(221)									0.85 (C)	0.85 (C)				
270(271)														
330(331)														
390(391)														
470(471)														
560(561)														
680(681)														
820(821)														
1000(102)														
1500(152)														
2200(222)														
3300(332)														
4700(472)														
6800(682)														
10000(103)														
15000(153)														
22000(223)														
33000(333)														
47000(473)														
68000(683)									0.85 (C)	0.85 (C)				
100000(104)														
150000(154)														
220000(224)														
470000(474)														
680000(684)														
1000000(105)														

※ Please consult us for special capacitance and high voltage(100V)

- Part Numbering System
- General Capacitors
- Ultra High Capacitors
- Super Small Capacitors
- High Voltage Capacitors
- Camera Strobe Circuit Capacitors
- Array Type Capacitors
- Low ESL Capacitors
- Reliability Test Condition
- Premium Capacitors for Automotive Applications
- Packaging Specification
- Application Manual for Surface Mounting

Product Line Up (Array Type Capacitors)

Part Number	TC Code	Temperature Characteristics	Element Type	Size L×W (mm)	Capacitance	Capacitance Tolerance	Rated Voltage (Vdc)	Thickness Max. (mm)
CL31C100JBCNBN □	COG(EIA)	±30ppm/°C(-55~+125°C)	4-Array	3.20×1.60	10pF	±5%	50	1.0
CL31C150JBCNBN □	COG(EIA)	±30ppm/°C(-55~+125°C)	4-Array	3.20×1.60	15pF	±5%	50	1.0
CL31C220JBCNBN □	COG(EIA)	±30ppm/°C(-55~+125°C)	4-Array	3.20×1.60	22pF	±5%	50	1.0
CL31C270JBCNBN □	COG(EIA)	±30ppm/°C(-55~+125°C)	4-Array	3.20×1.60	27pF	±5%	50	1.0
CL31C330KBCNBN □	COG(EIA)	±30ppm/°C(-55~+125°C)	4-Array	3.20×1.60	33pF	±10%	50	1.0
CL31C390KBCNBN □	COG(EIA)	±30ppm/°C(-55~+125°C)	4-Array	3.20×1.60	39pF	±10%	50	1.0
CL31C470JBCNBN □	COG(EIA)	±30ppm/°C(-55~+125°C)	4-Array	3.20×1.60	47pF	±5%	50	1.0
CL31C680JBCNBN □	COG(EIA)	±30ppm/°C(-55~+125°C)	4-Array	3.20×1.60	68pF	±5%	50	1.0
CL31C820JBCNBN □	COG(EIA)	±30ppm/°C(-55~+125°C)	4-Array	3.20×1.60	82pF	±5%	50	1.0
CL31C101JBCNBN □	COG(EIA)	±30ppm/°C(-55~+125°C)	4-Array	3.20×1.60	100pF	±5%	50	1.0
CL31C151KBCNBN □	COG(EIA)	±30ppm/°C(-55~+125°C)	4-Array	3.20×1.60	150pF	±10%	50	1.0
CL31C181JBCNBN □	COG(EIA)	±30ppm/°C(-55~+125°C)	4-Array	3.20×1.60	180pF	±5%	50	1.0
CL31C331JBCNBN □	COG(EIA)	±30ppm/°C(-55~+125°C)	4-Array	3.20×1.60	330pF	±5%	50	1.0
CL31C471JBCNBN □	COG(EIA)	±30ppm/°C(-55~+125°C)	4-Array	3.20×1.60	470pF	±5%	50	1.0

Part Number	TC Code	Temperature Characteristics	Element Type	Size L×W (mm)	Capacitance	Capacitance Tolerance	Rated Voltage (Vdc)	Thickness Max. (mm)
CL21B471KBCNBN □	X7R(EIA)	±15%(-55~+125°C)	4-Array	2.00×1.25	470pF	±10%	50	0.95
CL31B102MBCNBN □	X7R(EIA)	±15%(-55~+125°C)	4-Array	3.20×1.60	1.0nF	±20%	50	1.0
CL31B103MBCNBN □	X7R(EIA)	±15%(-55~+125°C)	4-Array	3.20×1.60	10nF	±20%	50	1.0
CL31B153KBCNBN □	X7R(EIA)	±15%(-55~+125°C)	4-Array	3.20×1.60	15nF	±10%	50	1.0
CL31B473KACNBN □	X7R(EIA)	±15%(-55~+125°C)	4-Array	3.20×1.60	47nF	±10%	25	1.0
CL31F473ZBCNBN □	Y5V(EIA)	-82~+22%(-30~+85°C)	4-Array	3.20×1.60	47nF	80%/±20%	50	1.0
CL31B104KACNBN □	X7R(EIA)	±15%(-55~+125°C)	4-Array	3.20×1.60	100nF	±10%	25	1.0
CL31F104ZACNBN □	Y5V(EIA)	-82~+22%(-30~+85°C)	4-Array	3.20×1.60	100nF	80%/±20%	25	1.0
CL14A105MA5NAN □	X5R(EIA)	±15%(-55~+85°C)	2-Array	1.40×1.00	1.0μF	±20%	25	0.55
CL14A105MO5NAN □	X5R(EIA)	±15%(-55~+85°C)	2-Array	1.40×1.00	1.0μF	±20%	16	0.55
CL21B104KOCNBN □	X7R(EIA)	±15%(-55~+125°C)	4-Array	2.00×1.25	100nF	±10%	16	0.95
CL31B104KOCNBN □	X7R(EIA)	±15%(-55~+125°C)	4-Array	3.20×1.60	100nF	±10%	16	1.0
CL21B104MPCNBN □	X7R(EIA)	±15%(-55~+125°C)	4-Array	2.00×1.25	100nF	±20%	10	0.95
CL14A105MO3NAN □	X5R(EIA)	±15%(-55~+85°C)	2-Array	1.40×1.00	1.0μF	±20%	16	0.40
CL21A105KOCNAN □	X5R(EIA)	±15%(-55~+85°C)	2-Array	2.00×1.25	1.0μF	±10%	16	0.95
CL14A105MO8NAN □	X5R(EIA)	±15%(-55~+85°C)	2-Array	1.40×1.00	1.0μF	±20%	16	0.88
CL14A105MP3NAN □	X5R(EIA)	±15%(-55~+85°C)	2-Array	1.40×1.00	1.0μF	±20%	10	0.40
CL14A105MP5NAN □	X5R(EIA)	±15%(-55~+85°C)	2-Array	1.40×1.00	1.0μF	±20%	10	0.55
CL14A105KP8NAN □	X5R(EIA)	±15%(-55~+85°C)	2-Array	1.40×1.00	1.0μF	±10%	10	0.88
CL21A105MPCNAN □	X5R(EIA)	±15%(-55~+85°C)	2-Array	2.00×1.25	1.0μF	±20%	10	0.95

※ □ mark means packaging code. If you want to learn the code or quantity in detail, please see p 81.

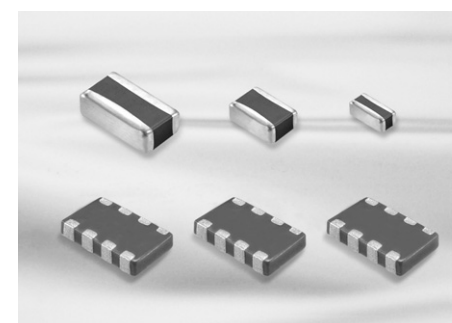

Feature

- Low ESL, good for noise reduction for high frequency
- Highly reliable tolerance and high speed automatic chip placement on PCBs
- Highly reliable performance
- Highly resistant termination metal
- Tape & reel for surface mount assembly

Application

- High Speed Microprocessor
- High Frequency Digital Equipment
- ※ For using special purpose like Military, Medical, Aviation, Automobile device should be following a special specification.

LICC(Low Inductance chip capacitor)

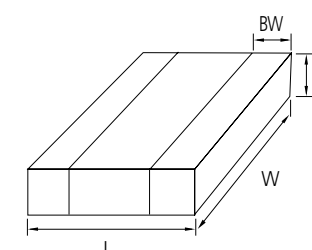

Code	EIA Code	Dimension(mm)			
		L	W	T	BW
L5	0204	0.52±0.05	1.0±0.05	0.3±0.05	0.18±0.08
01	0306	0.8±0.15	1.6±0.2	0.5+0.05/-0.1	0.25±0.15
12	0508	1.25±0.1	2.0±0.1	0.5±0.1 0.85±0.1	0.2 min.
13	0612	1.6±0.2	3.2±0.2	0.85±0.1 1.25±0.15	0.35 min.

SLIC(Super Low Inductance capacitor)

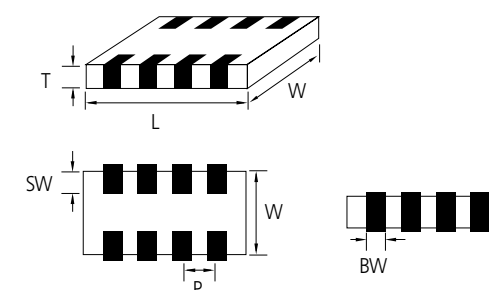

Code	EIA Code	Dimension(mm)					
		L	W	T	BW	SW	P
10	0603	1.6±0.1	0.8±0.1	0.5/+0.05-0.1	0.25±0.1	0.15±0.1	0.4±0.1
21	0805	2.0±0.1	1.25±0.1	0.5/+0.05-0.1	0.25±0.1	0.18±0.1	0.5±0.1
21	0805	2.0±0.1	1.25±0.1	0.85±0.1	0.25±0.1	0.18±0.1	0.5±0.1
31	1206	3.2±0.15	1.6±0.15	0.85±0.1	0.4±0.2	0.3±0.15	0.8±0.2

Part Numbering System

General Capacitors

Ultra High Capacitors

Super Small Capacitors

High Voltage Capacitors

Camera Strobe Circuit Capacitors

Array Type Capacitors

Low ESL Capacitors

Reliability Test Condition

Premium Capacitors for Automotive Applications

Packaging Specification

Application Manual for Surface Mounting

Capacitance Table (Low ESL Capacitors)

Size	LICC										SLIC			
	0204(L5)		0306(01)				0612(13)		0603(10)	0805(21)				
	X6S(X) / X7S(Y) / X5R(A) / X7R(B)													
TC	4(R)	6.3(Q)	4(R)	6.3(Q)	10(P)	16(O)	25(A)	50(B)	6.3(Q)	50(B)	4(R)	4(R)	6.3(Q)	16(O)
Rated V	4(R)	6.3(Q)	4(R)	6.3(Q)	10(P)	16(O)	25(A)	50(B)	6.3(Q)	50(B)	4(R)	4(R)	6.3(Q)	16(O)
Capacitance table -uF - (part numbering code) and thiness -mm-														
0.01(103)														
0.015(153)								0.5 (5)						
0.022(223)														
0.033(333)														
0.047(473)							0.5 (5)				0.5 (5)			
0.068(683)														
0.1(104)		0.3 (3)					0.5 (5)							
0.15(154)														
0.22(224)				0.5 (5)	0.5 (5)									0.5 (5)
0.33(334)	0.3 (3)													
0.47(474)				0.5 (5)										
0.68(684)											0.5 (5)		0.5 (5)	
1.0(105)											0.5 (5)	0.5 (5)		
1.5(155)				0.5 (5)										
2.2(225)														
3.3(335)														
4.7(475)								0.5 (5)						
10(106)														

Legend: :X7R(B) :X5R(A) :Y5V(F) :C0G(C) :X6S(X) :X7S(Y)

Product Line Up (Low ESL Capacitors)

Part Number	TC Code	Temperature Characteristics	Size L×W (mm)	Capacitance	Capacitance Tolerance	Rated Voltage (Vdc)	Thickness Max. (mm)
CL01B103KB5NLNB □	X7R(EIA)	±15%(-55~+125℃)	0.80×1.60	10nF	±10%	50	0.55
CL01B153KB5NLNB □	X7R(EIA)	±15%(-55~+125℃)	0.80×1.60	15nF	±10%	50	0.55
CL01B223KB5NLNB □	X7R(EIA)	±15%(-55~+125℃)	0.80×1.60	22nF	±10%	50	0.55
CL13B104KB5NLNB □	X7R(EIA)	±15%(-55~+125℃)	1.60×3.20	100nF	±10%	50	0.60
CL01B333KA5NLNB □	X7R(EIA)	±15%(-55~+125℃)	0.80×1.60	33nF	±10%	25	0.55
CL01B473KA5NLNB □	X7R(EIA)	±15%(-55~+125℃)	0.80×1.60	47nF	±10%	25	0.55
CL01B683KO5NLNB □	X7R(EIA)	±15%(-55~+125℃)	0.80×1.60	68nF	±10%	16	0.55
CL01B104KO5NLNB □	X7R(EIA)	±15%(-55~+125℃)	0.80×1.60	100nF	±10%	16	0.55
CL21B104MO5NUN □	X7R(EIA)	±15%(-55~+125℃)	2.00×1.25	100nF	±20%	16	0.55
CL21B684MO5NUN □	X7R(EIA)	±15%(-55~+125℃)	2.00×1.25	680nF	±20%	16	0.55
CL01B154KP5NLNB □	X7R(EIA)	±15%(-55~+125℃)	0.80×1.60	150nF	±10%	10	0.55
CL01B224KP5NLNB □	X7R(EIA)	±15%(-55~+125℃)	0.80×1.60	220nF	±10%	10	0.55
CLL5Y104MQ3NLN □	X7S(EIA)	±22%(-55~+125℃)	0.50×1.00	100nF	±20%	6.3	0.35
CL01A334KQ5NLNB □	X5R(EIA)	±15%(-55~+85℃)	0.80×1.60	330nF	±10%	6.3	0.55
CL01A474KQ5NLNB □	X5R(EIA)	±15%(-55~+85℃)	0.80×1.60	470nF	±10%	6.3	0.55
CL01A684KQ5NLNB □	X5R(EIA)	±15%(-55~+85℃)	0.80×1.60	680nF	±10%	6.3	0.55
CL21B684MQ5NUN □	X7R(EIA)	±15%(-55~+125℃)	2.00×1.25	680nF	±20%	6.3	0.55
CL01A105KQ5NLNB □	X5R(EIA)	±15%(-55~+85℃)	0.80×1.60	1.0μF	±10%	6.3	0.55
CL13A106MQFNLNB □	X5R(EIA)	±15%(-55~+85℃)	1.60×3.20	10μF	±20%	6.3	1.40
CLL5X224MR3NLN □	X6S(EIA)	±22%(-55~+105℃)	0.50×1.00	220nF	±20%	4.0	0.35
CL10Y474MR5NUN □	X7S(EIA)	±22%(-55~+125℃)	1.60×0.80	470nF	±20%	4.0	0.55
CLL5X474MR3NLN □	X6S(EIA)	±22%(-55~+105℃)	0.50×1.00	470nF	±20%	4.0	0.35
CL01Y105MR5NLN □	X7S(EIA)	±22%(-55~+125℃)	0.80×1.60	1.0μF	±20%	4.0	0.55
CL01Y105MR5NUN □	X7S(EIA)	±22%(-55~+125℃)	1.60×0.80	1.0μF	±20%	4.0	0.55
CL21Y105MR5NUN □	X7S(EIA)	±22%(-55~+125℃)	2.00×1.25	1.0μF	±20%	4.0	0.55
CL01Y225MR5NLN □	X7S(EIA)	±22%(-55~+125℃)	0.80×1.60	2.2μF	±20%	4.0	0.55
CL10Y225MR5NUN □	X7S(EIA)	±22%(-55~+125℃)	1.60×0.80	2.2μF	±20%	4.0	0.55

※ □ mark means packaging code. If you want to learn the code or quantity in detail, please see p 81.

Part Numbering System

General Capacitors

Ultra High Capacitors

Super Small Capacitors

High Voltage Capacitors

Camera Strobe Circuit Capacitors

Array Type Capacitors

Low ESL Capacitors

Reliability Test Condition

Premium Capacitors for Automotive Applications

Packaging Specification

Application Manual for Surface Mounting

No	Item	Performance	Test Condition																											
1	Appearance	No abnormal exterior appearance	Visual Inspection through Microscope(× 10)																											
2	Insulation Resistance	10,000MΩ min. or 500MΩ · μF min.(or *100MΩ · μF) product whichever is smaller (Rated voltage ≤ 16V: 10,000MΩ min. or 100MΩ · μF min. product whichever is smaller)	Apply the rated voltage for 60~120 sec. Rated voltage > 500V: Insulation Resistance shall be measured with 500 ± 50Vdc																											
3	Withstanding Voltage	No dielectric breakdown or mechanical breakdown	Apply the specified voltage* for 1~5 sec. Charge/Discharge current limit: 50mA max. *CLASS I (Rated Voltage < 100V): 300% of the rated Voltage CLASS II (Rated Voltage < 100V): 250% of the rated Voltage In the case of Vr ≥ 100V products, following condition should be applied. 100V ≤ Rated Voltage < 500V: 200% of the rated Voltage 500V ≤ Rated Voltage < 1000V: 150% of the rated Voltage Rated Voltage ≥ 1000V: 120% of the rated Voltage																											
4	Capacitance	CLASS I Within the specified tolerance	<table border="1"> <thead> <tr> <th>Capacitance</th> <th>Frequency</th> <th>Voltage</th> </tr> </thead> <tbody> <tr> <td>≤ 1,000pF</td> <td>1MHz ± 10%</td> <td rowspan="2">0.5 ~ 5 Vrms</td> </tr> <tr> <td>> 1,000pF</td> <td>1KHz ± 10%</td> </tr> </tbody> </table>	Capacitance	Frequency	Voltage	≤ 1,000pF	1MHz ± 10%	0.5 ~ 5 Vrms	> 1,000pF	1KHz ± 10%																			
		Capacitance	Frequency	Voltage																										
≤ 1,000pF	1MHz ± 10%	0.5 ~ 5 Vrms																												
> 1,000pF	1KHz ± 10%																													
CLASS II Within the specified tolerance	<table border="1"> <thead> <tr> <th>Capacitance</th> <th>Frequency</th> <th>Voltage</th> </tr> </thead> <tbody> <tr> <td>≤ 10μF</td> <td>1KHz ± 10%</td> <td rowspan="2">1.0 ± 0.2 Vrms</td> </tr> <tr> <td>> 10μF</td> <td>120Hz ± 20%</td> </tr> <tr> <td>*</td> <td>1KHz ± 10%</td> <td>0.5 ± 0.1 Vrms</td> </tr> </tbody> </table>	Capacitance	Frequency	Voltage	≤ 10μF	1KHz ± 10%	1.0 ± 0.2 Vrms	> 10μF	120Hz ± 20%	*	1KHz ± 10%	0.5 ± 0.1 Vrms																		
Capacitance	Frequency	Voltage																												
≤ 10μF	1KHz ± 10%	1.0 ± 0.2 Vrms																												
> 10μF	120Hz ± 20%																													
*	1KHz ± 10%	0.5 ± 0.1 Vrms																												
5	Tanδ	CLASS I Capacitance ≥ 30pF : Q ≥ 1,000 < 30pF : Q ≥ 400 + 20 × C (C : Capacitance)	<table border="1"> <thead> <tr> <th>Capacitance</th> <th>Frequency</th> <th>Voltage</th> </tr> </thead> <tbody> <tr> <td>≤ 1,000pF</td> <td>1MHz ± 10%</td> <td rowspan="2">0.5 ~ 5 Vrms</td> </tr> <tr> <td>> 1,000pF</td> <td>1KHz ± 10%</td> </tr> </tbody> </table>	Capacitance	Frequency	Voltage	≤ 1,000pF	1MHz ± 10%	0.5 ~ 5 Vrms	> 1,000pF	1KHz ± 10%																			
		Capacitance	Frequency	Voltage																										
≤ 1,000pF	1MHz ± 10%	0.5 ~ 5 Vrms																												
> 1,000pF	1KHz ± 10%																													
CLASS II	<p>1. Characteristic: A(X5R)</p> <table border="1"> <thead> <tr> <th>Rated Voltage</th> <th>Spec</th> </tr> </thead> <tbody> <tr> <td>50V / 35V</td> <td>0.025 max / 0.05 max*</td> </tr> <tr> <td>25V</td> <td>0.025 max / 0.05 max* / 0.10 max*</td> </tr> <tr> <td>16V</td> <td>0.035 max / 0.05 max* / 0.10 max*</td> </tr> <tr> <td>≤ 10V</td> <td>0.05 max / 0.10 max*</td> </tr> </tbody> </table> <p>2. Characteristic: B(X7R), X(X6S), Y(X7S)</p> <table border="1"> <thead> <tr> <th>Rated Voltage</th> <th>Spec</th> </tr> </thead> <tbody> <tr> <td>50V ≥ / 35V / 25V</td> <td>0.025 max / 0.05 max* / 0.10 max*</td> </tr> <tr> <td>16V</td> <td>0.035 max / 0.10 max*</td> </tr> <tr> <td>≤ 10V</td> <td>0.05 max / 0.10 max*</td> </tr> </tbody> </table> <p>3. Characteristic: F(Y5V)</p> <table border="1"> <thead> <tr> <th>Rated Voltage</th> <th>Spec</th> </tr> </thead> <tbody> <tr> <td>50V / 35V / 25V</td> <td>0.05 max / 0.07 max* / 0.09 max*</td> </tr> <tr> <td>16V</td> <td>0.07 max / 0.09 max* / 0.125 max*</td> </tr> <tr> <td>10V</td> <td>0.125 max / 0.16 max*</td> </tr> <tr> <td>≤ 6.3V</td> <td>0.16 max</td> </tr> </tbody> </table>	Rated Voltage	Spec	50V / 35V	0.025 max / 0.05 max*	25V	0.025 max / 0.05 max* / 0.10 max*	16V	0.035 max / 0.05 max* / 0.10 max*	≤ 10V	0.05 max / 0.10 max*	Rated Voltage	Spec	50V ≥ / 35V / 25V	0.025 max / 0.05 max* / 0.10 max*	16V	0.035 max / 0.10 max*	≤ 10V	0.05 max / 0.10 max*	Rated Voltage	Spec	50V / 35V / 25V	0.05 max / 0.07 max* / 0.09 max*	16V	0.07 max / 0.09 max* / 0.125 max*	10V	0.125 max / 0.16 max*	≤ 6.3V	0.16 max	You can check the specification at the web site or contact sales people for each product with mark*
Rated Voltage	Spec																													
50V / 35V	0.025 max / 0.05 max*																													
25V	0.025 max / 0.05 max* / 0.10 max*																													
16V	0.035 max / 0.05 max* / 0.10 max*																													
≤ 10V	0.05 max / 0.10 max*																													
Rated Voltage	Spec																													
50V ≥ / 35V / 25V	0.025 max / 0.05 max* / 0.10 max*																													
16V	0.035 max / 0.10 max*																													
≤ 10V	0.05 max / 0.10 max*																													
Rated Voltage	Spec																													
50V / 35V / 25V	0.05 max / 0.07 max* / 0.09 max*																													
16V	0.07 max / 0.09 max* / 0.125 max*																													
10V	0.125 max / 0.16 max*																													
≤ 6.3V	0.16 max																													

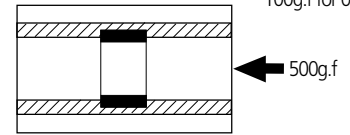
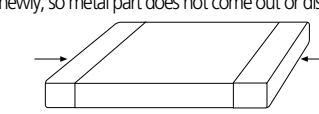
No	Item	Performance	Test Condition																	
6	Temperature Characteristics of Capacitance	CLASS I	<table border="1"> <thead> <tr> <th>Characteristic</th> <th>Temp. Coefficient (PPM/°C)</th> </tr> </thead> <tbody> <tr> <td>C</td> <td>0 ± 30</td> </tr> <tr> <td>P</td> <td>-150 ± 60</td> </tr> <tr> <td>R</td> <td>-220 ± 60</td> </tr> <tr> <td>S</td> <td>-330 ± 60</td> </tr> <tr> <td>T</td> <td>-470 ± 60</td> </tr> <tr> <td>U</td> <td>-750 ± 120</td> </tr> <tr> <td>S</td> <td>+350 ~ -1000</td> </tr> </tbody> </table>	Characteristic	Temp. Coefficient (PPM/°C)	C	0 ± 30	P	-150 ± 60	R	-220 ± 60	S	-330 ± 60	T	-470 ± 60	U	-750 ± 120	S	+350 ~ -1000	Capacitance shall be measured by the steps shown in the following table.
		Characteristic	Temp. Coefficient (PPM/°C)																	
C	0 ± 30																			
P	-150 ± 60																			
R	-220 ± 60																			
S	-330 ± 60																			
T	-470 ± 60																			
U	-750 ± 120																			
S	+350 ~ -1000																			
CLASS II	<table border="1"> <thead> <tr> <th>Characteristic</th> <th>Capacitance Change (%) with No bias</th> </tr> </thead> <tbody> <tr> <td>A(X5R) / B(X7R)</td> <td>± 15%</td> </tr> <tr> <td>X(X6S), Y(X7S)</td> <td>± 22%</td> </tr> <tr> <td>F(Y5V)</td> <td>+22% ~ -82%</td> </tr> </tbody> </table>	Characteristic	Capacitance Change (%) with No bias	A(X5R) / B(X7R)	± 15%	X(X6S), Y(X7S)	± 22%	F(Y5V)	+22% ~ -82%	<p>(1) CLASS I Temperature Coefficient shall be calculated from the formula as below Temp. Coefficient = $\frac{C2 - C1}{C1 \times \Delta T} \times 10^6$ [ppm/°C] C1: Capacitance at step 3 C2: Capacitance at 85°C ΔT: 60°C (= 85°C - 25°C)</p> <p>(2) CLASS II Capacitance Change shall be calculated from the formula as below ΔC = $\frac{C2 - C1}{C1} \times 100$ (%) C1: Capacitance at step 3 C2: Capacitance at step 2 or 4</p>										
Characteristic	Capacitance Change (%) with No bias																			
A(X5R) / B(X7R)	± 15%																			
X(X6S), Y(X7S)	± 22%																			
F(Y5V)	+22% ~ -82%																			
7	Adhesive Strength of Termination	No indication of peeling shall occur on the terminal electrode	Apply 500g.f* pressure for 10 ± 1 sec. *200g.f for 0201 *100g.f for 0402 																	
8	Bending Strength	Appearance	No indication of peeling shall occur																	
		Capacitance	<table border="1"> <thead> <tr> <th>Characteristic</th> <th>Capacitance Change</th> </tr> </thead> <tbody> <tr> <td>CLASS I</td> <td>± 5% or ± 0.5 pF whichever is larger</td> </tr> <tr> <td>CLASS II</td> <td>A(X5R), B(X7R), X(X6S), Y(X7S) ± 12.5% F(Y5V) ± 30%</td> </tr> </tbody> </table>	Characteristic	Capacitance Change	CLASS I	± 5% or ± 0.5 pF whichever is larger	CLASS II	A(X5R), B(X7R), X(X6S), Y(X7S) ± 12.5% F(Y5V) ± 30%											
Characteristic	Capacitance Change																			
CLASS I	± 5% or ± 0.5 pF whichever is larger																			
CLASS II	A(X5R), B(X7R), X(X6S), Y(X7S) ± 12.5% F(Y5V) ± 30%																			
9	Solderability	More than 75% of the terminal surface is to be soldered newly, so metal part does not come out or dissolve 	<table border="1"> <thead> <tr> <th>Solder</th> <th>Sr-3Ag-0.5Cu</th> <th>63Sn-37Pb</th> </tr> </thead> <tbody> <tr> <td>Solder Temp.</td> <td>245 ± 5°C</td> <td>235 ± 5°C</td> </tr> <tr> <td>Flux</td> <td colspan="2">RMA Type</td> </tr> <tr> <td>Dip time</td> <td>3 ± 0.3 sec.</td> <td>5 ± 0.5 sec.</td> </tr> <tr> <td>Pre-heating</td> <td colspan="2">at 80~120°C for 10~30 sec.</td> </tr> </tbody> </table>	Solder	Sr-3Ag-0.5Cu	63Sn-37Pb	Solder Temp.	245 ± 5°C	235 ± 5°C	Flux	RMA Type		Dip time	3 ± 0.3 sec.	5 ± 0.5 sec.	Pre-heating	at 80~120°C for 10~30 sec.			
Solder	Sr-3Ag-0.5Cu	63Sn-37Pb																		
Solder Temp.	245 ± 5°C	235 ± 5°C																		
Flux	RMA Type																			
Dip time	3 ± 0.3 sec.	5 ± 0.5 sec.																		
Pre-heating	at 80~120°C for 10~30 sec.																			
10	Resistance to Soldering Heat	Appearance	No mechanical damage shall occur	Solder temperature: 270 ± 5°C DIP TIME: 10 ± 1 sec. Each termination shall be fully immersed and preheated as below: <table border="1"> <thead> <tr> <th>Step</th> <th>Temperature(°C)</th> <th>Time (sec.)</th> </tr> </thead> <tbody> <tr> <td>1</td> <td>80~100</td> <td>60</td> </tr> <tr> <td>2</td> <td>150~180</td> <td>60</td> </tr> </tbody> </table> Leave the capacitor in ambient condition for specified time* before measurement *24 ± 2 hours(CLASS I) 24 ± 2 hours(CLASS II)	Step	Temperature(°C)	Time (sec.)	1	80~100	60	2	150~180	60							
		Step	Temperature(°C)		Time (sec.)															
		1	80~100		60															
		2	150~180		60															
		Capacitance	<table border="1"> <thead> <tr> <th>Characteristic</th> <th>Capacitance Change</th> </tr> </thead> <tbody> <tr> <td>CLASS I</td> <td>± 2.5% or ± 0.25 pF whichever is larger</td> </tr> <tr> <td>CLASS II</td> <td>A(X5R), B(X7R) X(X6S), Y(X7S) ± 7.5% F(Y5V) ± 20%</td> </tr> </tbody> </table>		Characteristic	Capacitance Change	CLASS I	± 2.5% or ± 0.25 pF whichever is larger	CLASS II	A(X5R), B(X7R) X(X6S), Y(X7S) ± 7.5% F(Y5V) ± 20%										
		Characteristic	Capacitance Change																	
CLASS I	± 2.5% or ± 0.25 pF whichever is larger																			
CLASS II	A(X5R), B(X7R) X(X6S), Y(X7S) ± 7.5% F(Y5V) ± 20%																			
Q (CLASS I)	Within the specified initial value																			
Tanδ (CLASS II)	Within the specified initial value																			
Insulation resistance	Within the specified initial value																			
Withstanding voltage	Within the specified initial value																			

- Part Numbering System
- General Capacitors
- Ultra High Capacitors
- Super Small Capacitors
- High Voltage Capacitors
- Camera Strobe Circuit Capacitors
- Array Type Capacitors
- Low ESL Capacitors
- Reliability Test Condition
- Premium Capacitors for Automotive Applications
- Packaging Specification
- Application Manual for Surface Mounting

No	Item	Performance	Test Condition		
11	Vibration Test	Appearance	No mechanical damage shall occur		
		Capacitance	Characteristic	Capacitance Change	
			CLASS I	± 2.5% or ± 0.25 pF whichever is larger	
			CLASS II	A(X5R), B(X7R)	± 5%
				X(X6S), Y(X7S)	± 10%
		F(Y5V)		± 20%	
		Q (CLASS I)	Within the specified initial value		
Tanδ (CLASS II)	Within the specified initial value				
Insulation resistance	Within the specified initial value				
12	Moisture Resistance	Appearance	No mechanical damage shall occur		
		Capacitance	Characteristic	Capacitance Change	
			CLASS I	± 7.5% or ± 0.75 pF whichever is larger	
			CLASS II	A(X5R), B(X7R), X(X6S), Y(X7S)	± 12.5%
				F(Y5V)	± 30%
		Q (CLASS I)	Capacitance ≥ 30 pF : Q ≥ 200 < 30 pF : Q ≥ 100+10/3 × C (C: Capacitance)		
		Tanδ (CLASS II)	1.Capacitance: A(X5R) 0.05 max / 0.075 max* (35V / 50V) 0.05 max / 0.075 max* / 0.125 max*(16V / 25V) 0.075 max / 0.125 max* (≤ 10V) 2.Capacitance: B(X7R), X(X6S) 0.05 max / 0.125 max* (16V / 25V / 35V / 50V ≥) 0.075 max / 0.125 max* (≤ 10V) 3.Capacitance: F(Y5V) 0.09 max (50V) 0.09 max / 0.125 max* (25V / 35V) 0.09 max / 0.125 max* / 0.16 max* (16V) 0.16 max / 0.195 max* (10V) 0.195 max (4V / 6.3V)		
Insulation resistance	500MΩ min. or 25MΩ · μF min. product whichever is smaller / 12.5MΩ · μF or over*				
13	High Temperature Resistance	Appearance	No mechanical damage shall occur		
		Capacitance	Characteristic	Capacitance Change	
			CLASS I	± 3% or ± 0.3 pF whichever is larger	
			CLASS II	A(X5R), B(X7R), X(X6S), Y(X7S)	± 12.5%
				F(Y5V)	± 30%
		Q (CLASS I)	Capacitance ≥ 30 pF : Q ≥ 350 10 ≤ Capacitance < 30 pF : Q ≥ 275+2.5 × C Capacitance < 10 pF : Q ≥ 200+10 × C (C: Capacitance)		
		Tanδ (CLASS II)	1.Capacitance: A(X5R) 0.05 max / 0.075 max* (35V / 50V) 0.05 max / 0.075 max* / 0.125 max*(16V / 25V) 0.075 max / 0.125 max* (≤ 10V) 2.Capacitance: B(X7R), X(X6S) 0.05 max / 0.125 max* (16V / 25V / 35V / 50V ≥) 0.075 max / 0.125 max* (≤ 10V) 3.Capacitance: F(Y5V) 0.09 max (50V) 0.09 max / 0.125 max* (25V / 35V) 0.09 max / 0.125 max* / 0.16 max* (16V) 0.16 max / 0.195 max* (10V) 0.195 max (4V / 6.3V)		
Insulation resistance	1,000MΩ min. or 50MΩ · μF min. product whichever is smaller / 25MΩ · μF or over*				

No	Item	Performance	Test Condition			
14	Temperature Cycle	Appearance	No mechanical damage shall occur			
		Capacitance	Characteristic	Capacitance Change		
			CLASS I	± 2.5% or ± 0.25 pF whichever is larger		
			CLASS II	A(X5R), B(X7R)	± 7.5%	
				X(X6S), Y(X7S)	± 15%	
		F(Y5V)		± 20%		
		Q (CLASS I)	Within the specified initial value			
Tanδ (CLASS II)	Within the specified initial value					
Insulation resistance	Within the specified initial value					
Capacitor shall be subjected to 5 cycles. Condition for 1 cycle:						
		Step	Temperature(°C)	Time(min.)		
		1	min. operating temperature +0/-3	30		
		2	25	2~3		
		3	max. operating temperature +0/-3	30		
		4	25	2~3		
Leave the capacitor in ambient condition for specified time* before measurement *24 ± 2 hours(CLASS I) 24 ± 2 hours(CLASS II)						
Recommended Soldering Method						
No	Item	Performance	Test Condition			
15	Recommended Soldering Method By Size & Capacitance	Size inch(mm)	Temperature Characteristic	Capacitance		
		01005(0402)	-	-	Condition	
		0201 (0603)			Flow	Reflow
		0402 (1005)			-	○
		0603(1608)	Class I	-	○	○
			Class II	C < 1 μF	○	○
		0805 (2012)	Class I	-	○	○
				C < 4.7 μF	○	○
			Class II	C ≥ 4.7 μF	-	○
		1206 (3216)	Array	-	-	○
			Class I	-	○	○
			Class II	C < 10 μF	○	○
		1210 (3225)	Class II	C ≥ 10 μF	-	○
				-	-	○
			Array	-	-	○
1210 (3225)	-		-	○		
1808 (4520)	-		-	○		
1812 (4532)	-		-	○		
2220 (5750)	-	-	○			

Note1. Initial Measurement For Class II

Perform the heat treatment at 150°C+0/-10°C for 1 hour. Then Leave the capacitor in ambient condition for 24 ± 2 hours before measurement. Then perform the measurement.

Note2. Latter Measurement

1. CLASS I
Leave the capacitor in ambient condition for 24 ± 2 hours before measurement. Then perform the measurement.

2. CLASS II
Perform the heat treatment at 150°C+0/-10°C for 1 hour. Then Leave the capacitor in ambient condition for 24 ± 2 hours before measurement. Then perform the measurement.

Note3. All Size in Reliability Test Condition Section is "inch"

Note4. Camera Strobe Circuit Capacitors Should be Following a Special Reliability Test Condition.
Please check with our sales representatives or product engineers.

- Part Numbering System
- General Capacitors
- Ultra High Capacitors
- Super Small Capacitors
- High Voltage Capacitors
- Camera Strobe Circuit Capacitors
- Array Type Capacitors
- Low ESL Capacitors
- Reliability Test Condition
- Premium Capacitors for Automotive Applications
- Packaging Specification
- Application Manual for Surface Mounting

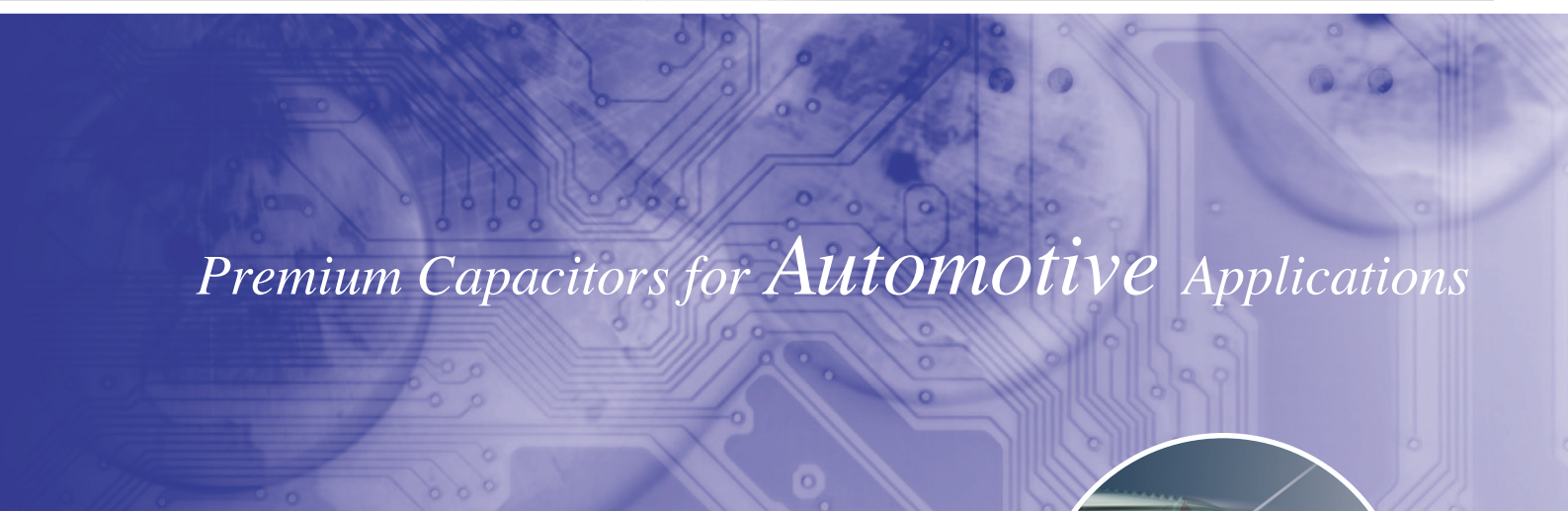
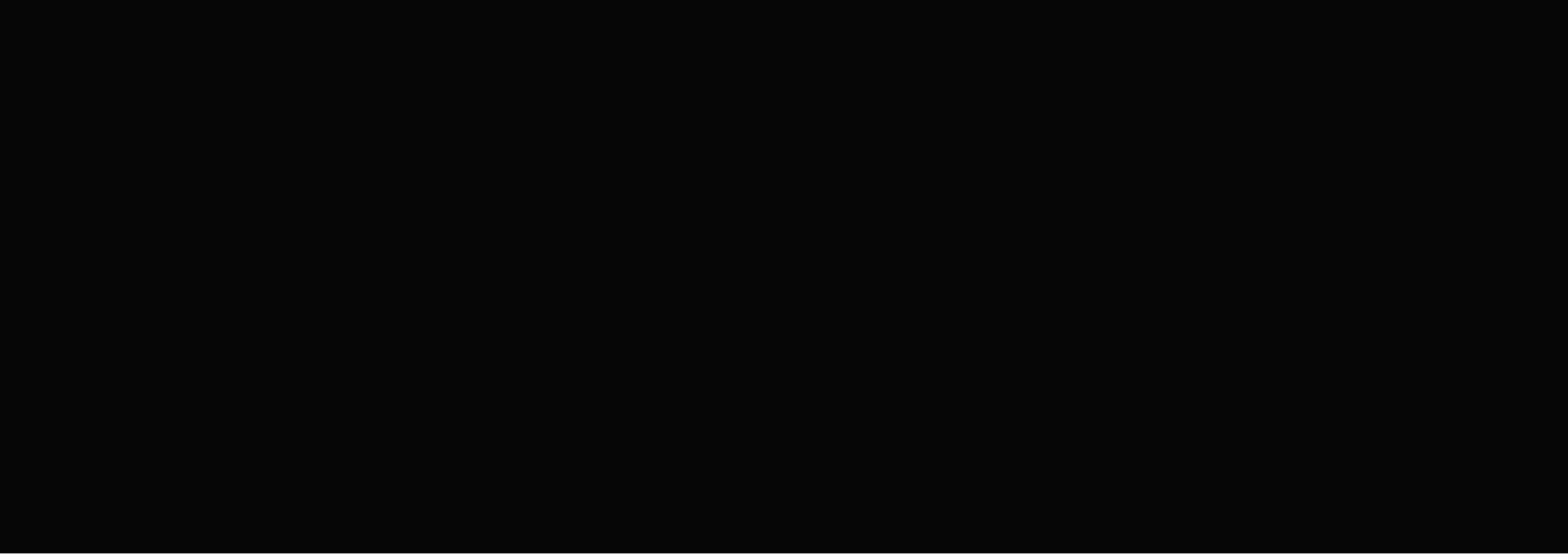

S A M S U N G E L E C T R O - M E C H A N I C S

Premium Capacitors for Automotive Applications

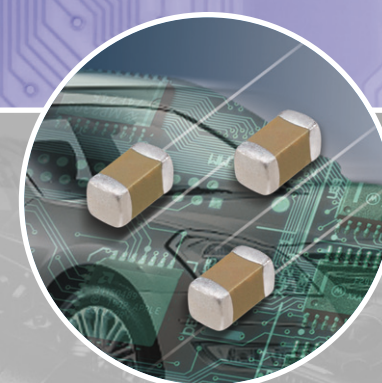

Part Numbering System (Automotive Capacitors)

	CL	31	B	225	K	B	H	4	P	N	E
	1	2	3	4	5	6	7	8	9	10	11

- 1. SERIES CODE** _____
 CL=Multi layer Ceramic Capacitors
- 2. SIZE CODE** — inch (mm) _____
 05=0402(1005) 21=0805(2012)
 10=0603(1608) 31=1206(3216)
- 3. DIELECTRIC CODE** _____
 Class I =C(COG) Class II=B(X7R)
- 4. CAPACITANCE CODE** _____
 Capacitance expressed in pF. 2 significant digits plus number of zeros.
 example) 106=10 × 10⁶=10000000pF
 For Values < 10pF, Letter R denotes decimal point
 example) 1R5=1.5pF
- 5. TOLERANCE CODE** _____
 10pF and Under : C=±0.25pF D=±0.5pF
 Over 10pF : J=±5% K=±10% M=±20%
 ※ This code has only typical specifications. Please refer to individual specifications.
- 6. RATED VOLTAGE CODE** _____
 O=16V B=50V
 A=25V C=100V
- 7. THICKNESS CODE** _____
 5 = 0.50mm 6= 0.60mm 8 = 0.80mm C = 0.85mm
 P = 1.15mm F = 1.25mm H = 1.60mm J = 2.50mm
 ※ This code has only typical specifications. Please refer to individual specifications.
- 8. DESIGN CODE** _____
 1=Standard
 4=Soft termination
 ※ This code has only typical specifications. Please refer to individual specifications.
- 9. PRODUCT CODE** _____
 P= AEC-Q200 Certificated
 ※ If orders are placed without returned specification, please allow us to judge that specification is accepted by your side.
- 10. GRADE CODE** _____
 N=Standard
- 11. PACKAGING CODE** _____
 B = Bulk O = Cardboard Tape, 10" Reel E = Embossed Type, 7" Reel
 P = Bulk Case D = Cardboard Tape, 13" Reel(10,000ea) F = Embossed Type, 13" Reel
 C = Cardboard Tape, 7" Reel L = Cardboard Tape, 13" Reel(15,000ea) S = Embossed Type, 10" Reel

This catalog has only typical specifications because there is no space for detailed specifications.
 Please approve our product specifications or transact the approval sheet for product specifications before ordering.

*** Class I**

Symbol	EIA Code	Operation Temperature Range(°C)	Temperature Coefficient Range(ppm/°C)
C	COG	-55 ~ +125	0 ±30

**** Class II**

Symbol	EIA Code	Operation Temperature Range(°C)	Capacitance Change (ΔC %)
B	X7R	-55 ~ +125	0 ±15

**** Capacitance Tolerance**

Code	Capacitance Tolerance	TC	Capacitance Step	Rated Capacitance
C	±0.25 pF	COG	Under 5 pF	E-12 series *
D	±0.5 pF	COG	6.0 to 9.0 pF	E-12 series *
J	±5%	COG	Over 10 pF	E-12 series
K	±10%	X7R	Under 0.01 μF	E-3 series
			Over 0.01 μF	E-6 series
M	±20%	X7R	Under 0.01 μF	E-3 series
			Over 0.01 μF	E-6 series

*E-24 series is also available

Series	Capacitance Step											
	1.0			2.2			4.7					
E-3	1.0			2.2			4.7					
E-6	1.0	1.5	2.2	3.3	4.7	6.8						
E-12	1.0	1.2	1.5	1.8	2.2	2.7	3.3	3.9	4.7	5.6	6.8	8.2
E-24	1.0	1.1	1.2	1.3	2.2	2.4	2.7	3.0	4.7	5.1	5.6	6.2
	1.5	1.6	1.8	2.0	3.3	3.6	3.9	4.3	6.8	7.5	8.2	9.1

Size	Code	Thickness(mm)	Spec(mm) *
0402(1005)	5	0.50	±0.05
0603(1608)	8	0.80	±0.10
0805(2012)	6	0.60	±0.10
	C	0.85	±0.10
	F	1.25	±0.10
1206(3216)	C	0.85	±0.15
	P	1.15	±0.10
	H	1.60	±0.20

*The tolerance will be changed by Customer' standards and our new products. (High Capacitance)
 Please check with our sales representatives or product engineers before ordering.

- Part Numbering System
- General Capacitors
- Ultra High Capacitors
- Super Small Capacitors
- High Voltage Capacitors
- Camera Strobe Circuit Capacitors
- Array Type Capacitors
- Low ESL Capacitors
- Reliability Test Condition
- Premium Capacitors for Automotive Applications
- Packaging Specification
- Application Manual for Surface Mounting

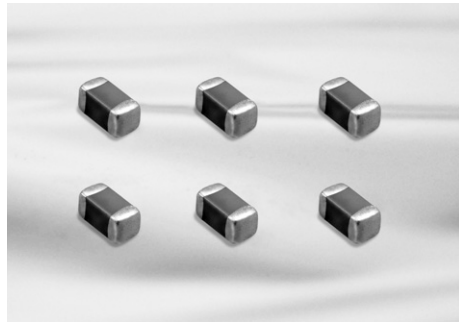

Feature

- Automotive products are manufactured in state of the art facilities recommended for registration to ISO/TS 16949:2002.
- Automotive products meet AEC-Q-200 requirements.
- Automotive products are RoHS compliant.
- Samsung terminations are suitable for all flow and reflow soldering systems. (10/21/31 size type only)
- Automotive products meet JEDEC-020-D requirements.
- COG dielectric components contain BME and copper terminations with a Ni/Sn plated overcoat.
- X7R dielectric components have BME and soft terminations with a Ni/Sn plated overcoat.

Application

- Automotive Electronic Equipment (Powertrain, Safety, Body & Chassis, Convenience, Infotainment)

Structure and Dimensions

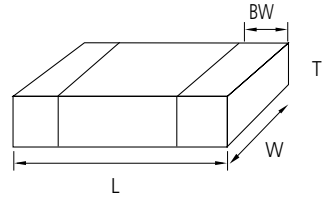

Code	EIA Code	Dimension(mm)			
		L	W	T	BW
05	0402	1.00±0.05	0.50±0.05	0.50(±0.05)	0.2+0.15/-0.1
10	0603	1.60±0.10	0.80±0.10	0.80(±0.10)	0.3±0.2
21	0805	2.00±0.10	1.25±0.10	0.60(±0.10)	0.5±0.2/-0.3
				0.85(±0.10)	
				1.25(±0.10)	
31	1206	3.20±0.20	1.60±0.20	0.85(±0.15)	0.5±0.3
				1.15(±0.10)	
				1.60(±0.20)	

Capacitance Table (Automotive Capacitors)

L x W[EIA]	0402(05)		0603(10)		0805(21)	
	COG(C)					
Part Number	50 (B)	100 (C)	50 (B)	100 (C)	50 (B)	100 (C)
Rated V (Code)	50 (B)	100 (C)	50 (B)	100 (C)	50 (B)	100 (C)
Capacitance -pF- (Capacitance part numbering code) and T (mm) Dimension (T Dimension part numbering code)						
10 pF(100)						
12 pF(120)						
15 pF(150)						
18 pF(180)						
22 pF(220)						
27 pF(270)						
33 pF(330)		0.50 (5)		0.80 (8)		
39 pF(390)	0.50 (5)					
47 pF(470)	0.50 (5)				0.60 (6)	
56 pF(560)						
68 pF(680)						
82 pF(820)			0.80 (8)			0.60 (6)
100 pF(101)						
120 pF(151)						
150 pF(151)						
180 pF(181)						
220 pF(221)						
270 pF(271)						
330 pF(331)						
390 pF(391)						
470 pF(471)						
560 pF(561)						
680 pF(681)						
820 pF(182)						
1000 pF(102)						1.25 (F) 0.85 (C)
1200 pF(122)						
1500 pF(152)						
1800 pF(182)						
2200 pF(222)						
2700 pF(272)						
3300 pF(332)						
3900 pF(392)						
4700 pF(472)						
5600 pF(562)						
6800 pF(682)						
8200 pF(822)						
10000 pF(103)						
12000 pF(123)						
15000 pF(153)						

COG(C)

Part Numbering System

General Capacitors

Ultra High Capacitors

Super Small Capacitors

High Voltage Capacitors

Camera Strobe Circuit Capacitors

Array Type Capacitors

Low ESL Capacitors

Reliability Test Condition

Premium Capacitors for Automotive Applications

Packaging Specification

Application Manual for Surface Mounting

Product Line Up (Automotive Capacitors)

Part Number	TC Code	Temperature Characteristics	Rated Voltage (Vdc)	Size L×W (mm)	Capacitance	Capacitance Tolerance	Thickness Max. (mm)
CL05C100JB5*PN□	COG(EIA)	±30ppm/°C(-55~+125°C)	50	1.00×0.50	10pF	±5%	0.55
CL05C120JB5*PN□	COG(EIA)	±30ppm/°C(-55~+125°C)	50	1.00×0.50	12pF	±5%	0.55
CL05C180JB5*PN□	COG(EIA)	±30ppm/°C(-55~+125°C)	50	1.00×0.50	18pF	±5%	0.55
CL05C220JB5*PN□	COG(EIA)	±30ppm/°C(-55~+125°C)	50	1.00×0.50	22pF	±5%	0.55
CL05C330JB5*PN□	COG(EIA)	±30ppm/°C(-55~+125°C)	50	1.00×0.50	33pF	±5%	0.55
CL05C390JB5*PN□	COG(EIA)	±30ppm/°C(-55~+125°C)	50	1.00×0.50	39pF	±5%	0.55
CL05C470JB5*PN□	COG(EIA)	±30ppm/°C(-55~+125°C)	50	1.00×0.50	47pF	±5%	0.55
CL05C560JB5*PN□	COG(EIA)	±30ppm/°C(-55~+125°C)	50	1.00×0.50	56pF	±5%	0.55
CL05C680JB5*PN□	COG(EIA)	±30ppm/°C(-55~+125°C)	50	1.00×0.50	68pF	±5%	0.55
CL05C820JB5*PN□	COG(EIA)	±30ppm/°C(-55~+125°C)	50	1.00×0.50	82pF	±5%	0.55
CL05C101JB5*PN□	COG(EIA)	±30ppm/°C(-55~+125°C)	50	1.00×0.50	100pF	±5%	0.55
CL05C151JB5*PN□	COG(EIA)	±30ppm/°C(-55~+125°C)	50	1.00×0.50	150pF	±5%	0.55
CL05C221JB5*PN□	COG(EIA)	±30ppm/°C(-55~+125°C)	50	1.00×0.50	220pF	±5%	0.55
CL05C100JC5*PN□	COG(EIA)	±30ppm/°C(-55~+125°C)	100	1.00×0.50	10pF	±5%	0.55
CL05C120JC5*PN□	COG(EIA)	±30ppm/°C(-55~+125°C)	100	1.00×0.50	12pF	±5%	0.55
CL05C180JC5*PN□	COG(EIA)	±30ppm/°C(-55~+125°C)	100	1.00×0.50	18pF	±5%	0.55
CL05C220JC5*PN□	COG(EIA)	±30ppm/°C(-55~+125°C)	100	1.00×0.50	22pF	±5%	0.55
CL05C330JC5*PN□	COG(EIA)	±30ppm/°C(-55~+125°C)	100	1.00×0.50	33pF	±5%	0.55
CL05C390JC5*PN□	COG(EIA)	±30ppm/°C(-55~+125°C)	100	1.00×0.50	39pF	±5%	0.55
CL05C470JC5*PN□	COG(EIA)	±30ppm/°C(-55~+125°C)	100	1.00×0.50	47pF	±5%	0.55
CL05C560JC5*PN□	COG(EIA)	±30ppm/°C(-55~+125°C)	100	1.00×0.50	56pF	±5%	0.55
CL05C680JC5*PN□	COG(EIA)	±30ppm/°C(-55~+125°C)	100	1.00×0.50	68pF	±5%	0.55
CL05C820JC5*PN□	COG(EIA)	±30ppm/°C(-55~+125°C)	100	1.00×0.50	82pF	±5%	0.55
CL05C101JC5*PN□	COG(EIA)	±30ppm/°C(-55~+125°C)	100	1.00×0.50	100pF	±5%	0.55
CL10C100JB8*PN□	COG(EIA)	±30ppm/°C(-55~+125°C)	50	1.60×0.80	10pF	±5%	0.90
CL10C120JB8*PN□	COG(EIA)	±30ppm/°C(-55~+125°C)	50	1.60×0.80	12pF	±5%	0.90
CL10C180JB8*PN□	COG(EIA)	±30ppm/°C(-55~+125°C)	50	1.60×0.80	18pF	±5%	0.90
CL10C220JB8*PN□	COG(EIA)	±30ppm/°C(-55~+125°C)	50	1.60×0.80	22pF	±5%	0.90
CL10C330JB8*PN□	COG(EIA)	±30ppm/°C(-55~+125°C)	50	1.60×0.80	33pF	±5%	0.90
CL10C390JB8*PN□	COG(EIA)	±30ppm/°C(-55~+125°C)	50	1.60×0.80	39pF	±5%	0.90
CL10C470JB8*PN□	COG(EIA)	±30ppm/°C(-55~+125°C)	50	1.60×0.80	47pF	±5%	0.90
CL10C560JB8*PN□	COG(EIA)	±30ppm/°C(-55~+125°C)	50	1.60×0.80	56pF	±5%	0.90
CL10C680JB8*PN□	COG(EIA)	±30ppm/°C(-55~+125°C)	50	1.60×0.80	68pF	±5%	0.90
CL10C820JB8*PN□	COG(EIA)	±30ppm/°C(-55~+125°C)	50	1.60×0.80	82pF	±5%	0.90
CL10C101JB8*PN□	COG(EIA)	±30ppm/°C(-55~+125°C)	50	1.60×0.80	100pF	±5%	0.90
CL10C151JB8*PN□	COG(EIA)	±30ppm/°C(-55~+125°C)	50	1.60×0.80	150pF	±5%	0.90
CL10C221JB8*PN□	COG(EIA)	±30ppm/°C(-55~+125°C)	50	1.60×0.80	220pF	±5%	0.90
CL10C331JB8*PN□	COG(EIA)	±30ppm/°C(-55~+125°C)	50	1.60×0.80	330pF	±5%	0.90
CL10C471JB8*PN□	COG(EIA)	±30ppm/°C(-55~+125°C)	50	1.60×0.80	470pF	±5%	0.90
CL10C681JB8*PN□	COG(EIA)	±30ppm/°C(-55~+125°C)	50	1.60×0.80	680pF	±5%	0.90

*mark means design code. If you want more information, Please check with our sales representatives or product engineers.

※ □mark means packaging code. If you want to learn the code or quantity in detail, please see p 81.

Product Line Up (Automotive Capacitors)

Part Number	TC Code	Temperature Characteristics	Rated Voltage (Vdc)	Size L×W (mm)	Capacitance	Capacitance Tolerance	Thickness Max. (mm)
CL10C102JB8*PN□	COG(EIA)	±30ppm/°C(-55~+125°C)	50	1.60×0.80	1.0nF	±5%	0.90
CL10C100JC8*PN□	COG(EIA)	±30ppm/°C(-55~+125°C)	100	1.60×0.80	10pF	±5%	0.90
CL10C120JC8*PN□	COG(EIA)	±30ppm/°C(-55~+125°C)	100	1.60×0.80	12pF	±5%	0.90
CL10C180JC8*PN□	COG(EIA)	±30ppm/°C(-55~+125°C)	100	1.60×0.80	18pF	±5%	0.90
CL10C220JC8*PN□	COG(EIA)	±30ppm/°C(-55~+125°C)	100	1.60×0.80	22pF	±5%	0.90
CL10C330JC8*PN□	COG(EIA)	±30ppm/°C(-55~+125°C)	100	1.60×0.80	33pF	±5%	0.90
CL10C390JC8*PN□	COG(EIA)	±30ppm/°C(-55~+125°C)	100	1.60×0.80	39pF	±5%	0.90
CL10C470JC8*PN□	COG(EIA)	±30ppm/°C(-55~+125°C)	100	1.60×0.80	47pF	±5%	0.90
CL10C560JC8*PN□	COG(EIA)	±30ppm/°C(-55~+125°C)	100	1.60×0.80	56pF	±5%	0.90
CL10C680JC8*PN□	COG(EIA)	±30ppm/°C(-55~+125°C)	100	1.60×0.80	68pF	±5%	0.90
CL10C820JC8*PN□	COG(EIA)	±30ppm/°C(-55~+125°C)	100	1.60×0.80	82pF	±5%	0.90
CL10C101JC8*PN□	COG(EIA)	±30ppm/°C(-55~+125°C)	100	1.60×0.80	100pF	±5%	0.90
CL21C100JB6*PN□	COG(EIA)	±30ppm/°C(-55~+125°C)	50	2.00×1.25	10pF	±5%	0.70
CL21C120JB6*PN□	COG(EIA)	±30ppm/°C(-55~+125°C)	50	2.00×1.25	12pF	±5%	0.70
CL21C180JB6*PN□	COG(EIA)	±30ppm/°C(-55~+125°C)	50	2.00×1.25	18pF	±5%	0.70
CL21C220JB6*PN□	COG(EIA)	±30ppm/°C(-55~+125°C)	50	2.00×1.25	22pF	±5%	0.70
CL21C330JB6*PN□	COG(EIA)	±30ppm/°C(-55~+125°C)	50	2.00×1.25	33pF	±5%	0.70
CL21C390JB6*PN□	COG(EIA)	±30ppm/°C(-55~+125°C)	50	2.00×1.25	39pF	±5%	0.70
CL21C470JB6*PN□	COG(EIA)	±30ppm/°C(-55~+125°C)	50	2.00×1.25	47pF	±5%	0.70
CL21C560JB6*PN□	COG(EIA)	±30ppm/°C(-55~+125°C)	50	2.00×1.25	56pF	±5%	0.70
CL21C680JB6*PN□	COG(EIA)	±30ppm/°C(-55~+125°C)	50	2.00×1.25	68pF	±5%	0.70
CL21C820JB6*PN□	COG(EIA)	±30ppm/°C(-55~+125°C)	50	2.00×1.25	82pF	±5%	0.70
CL21C101JB6*PN□	COG(EIA)	±30ppm/°C(-55~+125°C)	50	2.00×1.25	100pF	±5%	0.70
CL21C151JB6*PN□	COG(EIA)	±30ppm/°C(-55~+125°C)	50	2.00×1.25	150pF	±5%	0.70
CL21C221JB6*PN□	COG(EIA)	±30ppm/°C(-55~+125°C)	50	2.00×1.25	220pF	±5%	0.70
CL21C331JB6*PN□	COG(EIA)	±30ppm/°C(-55~+125°C)	50	2.00×1.25	330pF	±5%	0.70
CL21C471JBC*PN□	COG(EIA)	±30ppm/°C(-55~+125°C)	50	2.00×1.25	470pF	±5%	0.95
CL21C681JBC*PN□	COG(EIA)	±30ppm/°C(-55~+125°C)	50	2.00×1.25	680pF	±5%	0.95
CL21C102JBC*PN□	COG(EIA)	±30ppm/°C(-55~+125°C)	50	2.00×1.25	1.0nF	±5%	0.95
CL21C102JBF*PN□	COG(EIA)	±30ppm/°C(-55~+125°C)	50	2.00×1.25	1.0nF	±5%	1.35
CL21C100JC6*PN□	COG(EIA)	±30ppm/°C(-55~+125°C)	100	2.00×1.25	10pF	±5%	0.70
CL21C120JC6*PN□	COG(EIA)	±30ppm/°C(-55~+125°C)	100	2.00×1.25	12pF	±5%	0.70
CL21C180JC6*PN□	COG(EIA)	±30ppm/°C(-55~+125°C)	100	2.00×1.25	18pF	±5%	0.70
CL21C220JC6*PN□	COG(EIA)	±30ppm/°C(-55~+125°C)	100	2.00×1.25	22pF	±5%	0.70
CL21C330JC6*PN□	COG(EIA)	±30ppm/°C(-55~+125°C)	100	2.00×1.25	33pF	±5%	0.70
CL21C390JC6*PN□	COG(EIA)	±30ppm/°C(-55~+125°C)	100	2.00×1.25	39pF	±5%	0.70
CL21C470JC6*PN□	COG(EIA)	±30ppm/°C(-55~+125°C)	100	2.00×1.25	47pF	±5%	0.70
CL21C560JC6*PN□	COG(EIA)	±30ppm/°C(-55~+125°C)	100	2.00×1.25	56pF	±5%	0.70
CL21C680JC6*PN□	COG(EIA)	±30ppm/°C(-55~+125°C)	100	2.00×1.25	68pF	±5%	0.70
CL21C820JC6*PN□	COG(EIA)	±30ppm/°C(-55~+125°C)	100	2.00×1.25	82pF	±5%	0.70
CL21C101JC6*PN□	COG(EIA)	±30ppm/°C(-55~+125°C)	100	2.00×1.25	100pF	±5%	0.70
CL21C151JC6*PN□	COG(EIA)	±30ppm/°C(-55~+125°C)	100	2.00×1.25	150pF	±5%	0.70

*mark means design code. If you want more information, Please check with our sales representatives or product engineers.

※ □mark means packaging code. If you want to learn the code or quantity in detail, please see p 81.

Part Numbering System

General Capacitors

Ultra High Capacitors

Super Small Capacitors

High Voltage Capacitors

Camera Strobe Circuit Capacitors

Array Type Capacitors

Low ESL Capacitors

Reliability Test Condition

Premium Capacitors for Automotive Applications

Packaging Specification

Application Manual for Surface Mounting

Product Line Up (Automotive Capacitors)

Part Number	TC Code	Temperature Characteristics	Rated Voltage (Vdc)	Size L×W (mm)	Capacitance	Capacitance Tolerance	Thickness Max. (mm)
CL21C221JCC*PN□	COG(EIA)	±30ppm/°C(-55~+125°C)	100	2.00×1.25	220pF	±5%	0.70
CL21C331JCC*PN□	COG(EIA)	±30ppm/°C(-55~+125°C)	100	2.00×1.25	330pF	±5%	0.70
CL21C471JCC*PN□	COG(EIA)	±30ppm/°C(-55~+125°C)	100	2.00×1.25	470pF	±5%	0.95
CL21C681JCC*PN□	COG(EIA)	±30ppm/°C(-55~+125°C)	100	2.00×1.25	680pF	±5%	0.95
CL21C102JCC*PN□	COG(EIA)	±30ppm/°C(-55~+125°C)	100	2.00×1.25	1.0nF	±5%	0.95
CL21C102JCF*PN□	COG(EIA)	±30ppm/°C(-55~+125°C)	100	2.00×1.25	1.0nF	±5%	1.35
CL21C122JBC*PN□	COG(EIA)	±30ppm/°C(-55~+125°C)	50	2.00×1.25	1.2nF	±5%	0.95
CL21C152JBC*PN□	COG(EIA)	±30ppm/°C(-55~+125°C)	50	2.00×1.25	1.5nF	±5%	0.95
CL21C182JBC*PN□	COG(EIA)	±30ppm/°C(-55~+125°C)	50	2.00×1.25	1.8nF	±5%	0.95
CL21C222JBC*PN□	COG(EIA)	±30ppm/°C(-55~+125°C)	50	2.00×1.25	2.2nF	±5%	0.95
CL21C272JBC*PN□	COG(EIA)	±30ppm/°C(-55~+125°C)	50	2.00×1.25	2.7nF	±5%	0.95
CL21C332JBC*PN□	COG(EIA)	±30ppm/°C(-55~+125°C)	50	2.00×1.25	3.3nF	±5%	0.95
CL21C392JBC*PN□	COG(EIA)	±30ppm/°C(-55~+125°C)	50	2.00×1.25	3.9nF	±5%	0.95
CL21C472JBC*PN□	COG(EIA)	±30ppm/°C(-55~+125°C)	50	2.00×1.25	4.7nF	±5%	0.95
CL21C562JBC*PN□	COG(EIA)	±30ppm/°C(-55~+125°C)	50	2.00×1.25	5.6nF	±5%	0.95
CL21C122JBF*PN□	COG(EIA)	±30ppm/°C(-55~+125°C)	50	2.00×1.25	1.2nF	±5%	1.35
CL21C152JBF*PN□	COG(EIA)	±30ppm/°C(-55~+125°C)	50	2.00×1.25	1.5nF	±5%	1.35
CL21C182JBF*PN□	COG(EIA)	±30ppm/°C(-55~+125°C)	50	2.00×1.25	1.8nF	±5%	1.35
CL21C222JBF*PN□	COG(EIA)	±30ppm/°C(-55~+125°C)	50	2.00×1.25	2.2nF	±5%	1.35
CL21C272JBF*PN□	COG(EIA)	±30ppm/°C(-55~+125°C)	50	2.00×1.25	2.7nF	±5%	1.35
CL21C332JBF*PN□	COG(EIA)	±30ppm/°C(-55~+125°C)	50	2.00×1.25	3.3nF	±5%	1.35
CL21C392JBF*PN□	COG(EIA)	±30ppm/°C(-55~+125°C)	50	2.00×1.25	3.9nF	±5%	1.35
CL21C472JBF*PN□	COG(EIA)	±30ppm/°C(-55~+125°C)	50	2.00×1.25	4.7nF	±5%	1.35
CL21C562JBF*PN□	COG(EIA)	±30ppm/°C(-55~+125°C)	50	2.00×1.25	5.6nF	±5%	1.35
CL21C682JBF*PN□	COG(EIA)	±30ppm/°C(-55~+125°C)	50	2.00×1.25	6.8nF	±5%	1.35
CL21C822JBF*PN□	COG(EIA)	±30ppm/°C(-55~+125°C)	50	2.00×1.25	8.2nF	±5%	1.35
CL21C103JBF*PN□	COG(EIA)	±30ppm/°C(-55~+125°C)	50	2.00×1.25	10.0nF	±5%	1.35

*mark means design code. If you want more information, please check with our sales representatives or product engineers.
 ※ □ mark means packaging code. If you want to learn the code or quantity in detail, please see p 81.

Capacitance Table (Automotive Capacitors)

Size	0603(10)				0805(21)				1206(31)			
	X7R(B)											
	16 (O)	25 (A)	50 (B)	100 (C)	16 (O)	25 (A)	50 (B)	100 (C)	16 (O)	25 (A)	50 (B)	100 (C)
220pF(221)												
470pF(471)												
1.0nF(102)				0.80 (8)								
2.2nF(222)												
4.7nF(472)												
10nF(103)								0.60 (6)		0.60 (6)		
15nF(153)												
22nF(223)												
33nF(333)			0.80 (8)									
47nF(473)								0.85 (C)		0.85 (C)		
68nF(683)	0.80 (8)							0.85 (C)				
100nF(104)								0.85 (C)		1.25 (F) 0.85 (C)		1.25 (F) 0.85 (C)
150nF(154)												1.15 (P)
220nF(224)												
330nF(334)								1.25 (F)				0.85 (C)
470nF(474)								1.25 (F)				
680nF(684)												
1000nF(105)											1.15 (P)	1.15 (P) 1.60 (H)
1500nF(155)											1.60 (H)	1.60 (H)
2200nF(225)												

■ :X7R(B)

Part Numbering System

General Capacitors

Ultra High Capacitors

Super Small Capacitors

High Voltage Capacitors

Camera Strobe Circuit Capacitors

Array Type Capacitors

Low ESL Capacitors

Reliability Test Condition

Premium Capacitors for Automotive Applications

Packaging Specification

Application Manual for Surface Mounting

Product Line Up (Automotive Capacitors)

Part Number	TC Code	Temperature Characteristics	Rated Voltage (Vdc)	Size L×W (mm)	Capacitance	Capacitance Tolerance	Thickness Max. (mm)
CL10B473K08*PN □	X7R(EIA)	± 15%(-55~+125℃)	16	1.60×0.80	47nF	± 10%	0.90
CL10B683K08*PN □	X7R(EIA)	± 15%(-55~+125℃)	16	1.60×0.80	68nF	± 10%	0.90
CL10B104K08*PN □	X7R(EIA)	± 15%(-55~+125℃)	16	1.60×0.80	100nF	± 10%	0.90
CL10B103KA8*PN □	X7R(EIA)	± 15%(-55~+125℃)	25	1.60×0.80	10nF	± 10%	0.90
CL10B153KA8*PN □	X7R(EIA)	± 15%(-55~+125℃)	25	1.60×0.80	15nF	± 10%	0.90
CL10B223KA8*PN □	X7R(EIA)	± 15%(-55~+125℃)	25	1.60×0.80	22nF	± 10%	0.90
CL10B333KA8*PN □	X7R(EIA)	± 15%(-55~+125℃)	25	1.60×0.80	33nF	± 10%	0.90
CL10B473KA8*PN □	X7R(EIA)	± 15%(-55~+125℃)	25	1.60×0.80	47nF	± 10%	0.90
CL10B683KA8*PN □	X7R(EIA)	± 15%(-55~+125℃)	25	1.60×0.80	68nF	± 10%	0.90
CL10B104KA8*PN □	X7R(EIA)	± 15%(-55~+125℃)	25	1.60×0.80	100nF	± 10%	0.90
CL10B102KB8*PN □	X7R(EIA)	± 15%(-55~+125℃)	50	1.60×0.80	1.0nF	± 10%	0.90
CL10B152KB8*PN □	X7R(EIA)	± 15%(-55~+125℃)	50	1.60×0.80	1.5nF	± 10%	0.90
CL10B222KB8*PN □	X7R(EIA)	± 15%(-55~+125℃)	50	1.60×0.80	2.2nF	± 10%	0.90
CL10B332KB8*PN □	X7R(EIA)	± 15%(-55~+125℃)	50	1.60×0.80	3.3nF	± 10%	0.90
CL10B472KB8*PN □	X7R(EIA)	± 15%(-55~+125℃)	50	1.60×0.80	4.7nF	± 10%	0.90
CL10B682KB8*PN □	X7R(EIA)	± 15%(-55~+125℃)	50	1.60×0.80	6.8nF	± 10%	0.90
CL10B103KB8*PN □	X7R(EIA)	± 15%(-55~+125℃)	50	1.60×0.80	10nF	± 10%	0.90
CL10B153KB8*PN □	X7R(EIA)	± 15%(-55~+125℃)	50	1.60×0.80	15nF	± 10%	0.90
CL10B223KB8*PN □	X7R(EIA)	± 15%(-55~+125℃)	50	1.60×0.80	22nF	± 10%	0.90
CL10B333KB8*PN □	X7R(EIA)	± 15%(-55~+125℃)	50	1.60×0.80	33nF	± 10%	0.90
CL10B473KB8*PN □	X7R(EIA)	± 15%(-55~+125℃)	50	1.60×0.80	47nF	± 10%	0.90
CL10B683KB8*PN □	X7R(EIA)	± 15%(-55~+125℃)	50	1.60×0.80	68nF	± 10%	0.90
CL10B104KB8*PN □	X7R(EIA)	± 15%(-55~+125℃)	50	1.60×0.80	100nF	± 10%	0.90
CL10B102KC8*PN □	X7R(EIA)	± 15%(-55~+125℃)	100	1.60×0.80	1.0nF	± 10%	0.90
CL10B152KC8*PN □	X7R(EIA)	± 15%(-55~+125℃)	100	1.60×0.80	1.5nF	± 10%	0.90
CL10B222KC8*PN □	X7R(EIA)	± 15%(-55~+125℃)	100	1.60×0.80	2.2nF	± 10%	0.90
CL10B332KC8*PN □	X7R(EIA)	± 15%(-55~+125℃)	100	1.60×0.80	3.3nF	± 10%	0.90
CL10B472KC8*PN □	X7R(EIA)	± 15%(-55~+125℃)	100	1.60×0.80	4.7nF	± 10%	0.90
CL10B682KC8*PN □	X7R(EIA)	± 15%(-55~+125℃)	100	1.60×0.80	6.8nF	± 10%	0.90
CL10B103KC8*PN □	X7R(EIA)	± 15%(-55~+125℃)	100	1.60×0.80	10nF	± 10%	0.90
CL10B221KC8*PN □	X7R(EIA)	± 15%(-55~+125℃)	100	1.60×0.80	220pF	± 10%	0.90
CL10B331KC8*PN □	X7R(EIA)	± 15%(-55~+125℃)	100	1.60×0.80	330pF	± 10%	0.90
CL10B471KC8*PN □	X7R(EIA)	± 15%(-55~+125℃)	100	1.60×0.80	470pF	± 10%	0.90

*mark means design code. If you want more information , Please check with our sales representatives or product engineers.
 ※ □mark means packaging code. If you want to learn the code or quantity in detail, please see p 81.

Product Line Up (Automotive Capacitors)

Part Number	TC Code	Temperature Characteristics	Rated Voltage (Vdc)	Size L×W (mm)	Capacitance	Capacitance Tolerance	Thickness Max. (mm)
CL10B681KC8*PN □	X7R(EIA)	± 15%(-55~+125℃)	100	1.60×0.80	680pF	± 10%	0.90
CL21B104KOC*PN □	X7R(EIA)	± 15%(-55~+125℃)	16	2.00×1.25	100nF	± 10%	0.95
CL21B154KOF*PN □	X7R(EIA)	± 15%(-55~+125℃)	16	2.00×1.25	150nF	± 10%	1.35
CL21B224KOF*PN □	X7R(EIA)	± 15%(-55~+125℃)	16	2.00×1.25	220nF	± 10%	1.35
CL21B334KOF*PN □	X7R(EIA)	± 15%(-55~+125℃)	16	2.00×1.25	330nF	± 10%	1.35
CL21B474KOF*PN □	X7R(EIA)	± 15%(-55~+125℃)	16	2.00×1.25	470nF	± 10%	1.35
CL21B473KAC*PN □	X7R(EIA)	± 15%(-55~+125℃)	25	2.00×1.25	47nF	± 10%	0.95
CL21B683KAC*PN □	X7R(EIA)	± 15%(-55~+125℃)	25	2.00×1.25	68nF	± 10%	0.95
CL21B104KAC*PN □	X7R(EIA)	± 15%(-55~+125℃)	25	2.00×1.25	100nF	± 10%	0.95
CL21B154KAF*PN □	X7R(EIA)	± 15%(-55~+125℃)	25	2.00×1.25	150nF	± 10%	1.35
CL21B224KAF*PN □	X7R(EIA)	± 15%(-55~+125℃)	25	2.00×1.25	220nF	± 10%	1.35
CL21B334KAF*PN □	X7R(EIA)	± 15%(-55~+125℃)	25	2.00×1.25	330nF	± 10%	1.35
CL21B474KAF*PN □	X7R(EIA)	± 15%(-55~+125℃)	25	2.00×1.25	470nF	± 10%	1.35
CL21B102KB6*PN □	X7R(EIA)	± 15%(-55~+125℃)	50	2.00×1.25	1.0nF	± 10%	0.70
CL21B152KB6*PN □	X7R(EIA)	± 15%(-55~+125℃)	50	2.00×1.25	1.5nF	± 10%	0.70
CL21B222KB6*PN □	X7R(EIA)	± 15%(-55~+125℃)	50	2.00×1.25	2.2nF	± 10%	0.70
CL21B332KB6*PN □	X7R(EIA)	± 15%(-55~+125℃)	50	2.00×1.25	3.3nF	± 10%	0.70
CL21B472KB6*PN □	X7R(EIA)	± 15%(-55~+125℃)	50	2.00×1.25	4.7nF	± 10%	0.70
CL21B682KB6*PN □	X7R(EIA)	± 15%(-55~+125℃)	50	2.00×1.25	6.8nF	± 10%	0.70
CL21B103KB6*PN □	X7R(EIA)	± 15%(-55~+125℃)	50	2.00×1.25	10nF	± 10%	0.70
CL21B153KB6*PN □	X7R(EIA)	± 15%(-55~+125℃)	50	2.00×1.25	15nF	± 10%	0.70
CL21B223KB6*PN □	X7R(EIA)	± 15%(-55~+125℃)	50	2.00×1.25	22nF	± 10%	0.70
CL21B333KBC*PN □	X7R(EIA)	± 15%(-55~+125℃)	50	2.00×1.25	33nF	± 10%	0.95
CL21B473KBC*PN □	X7R(EIA)	± 15%(-55~+125℃)	50	2.00×1.25	47nF	± 10%	0.95
CL21B683KBC*PN □	X7R(EIA)	± 15%(-55~+125℃)	50	2.00×1.25	68nF	± 10%	0.95
CL21B104KBC*PN □	X7R(EIA)	± 15%(-55~+125℃)	50	2.00×1.25	100nF	± 10%	0.95
CL21B104KBF*PN □	X7R(EIA)	± 15%(-55~+125℃)	50	2.00×1.25	100nF	± 10%	1.35
CL21B154KBF*PN □	X7R(EIA)	± 15%(-55~+125℃)	50	2.00×1.25	150nF	± 10%	1.35
CL21B224KBF*PN □	X7R(EIA)	± 15%(-55~+125℃)	50	2.00×1.25	220nF	± 10%	1.35
CL21B334KBF*PN □	X7R(EIA)	± 15%(-55~+125℃)	50	2.00×1.25	330nF	± 10%	1.35
CL21B474KBF*PN □	X7R(EIA)	± 15%(-55~+125℃)	50	2.00×1.25	470nF	± 10%	1.35
CL21B102KC6*PN □	X7R(EIA)	± 15%(-55~+125℃)	100	2.00×1.25	1.0nF	± 10%	0.70
CL21B152KC6*PN □	X7R(EIA)	± 15%(-55~+125℃)	100	2.00×1.25	1.5nF	± 10%	0.70

*mark means design code. If you want more information , Please check with our sales representatives or product engineers.
 ※ □mark means packaging code. If you want to learn the code or quantity in detail, please see p 81.

Part Numbering System

General Capacitors

Ultra High Capacitors

Super Small Capacitors

High Voltage Capacitors

Camera Strobe Circuit Capacitors

Array Type Capacitors

Low ESL Capacitors

Reliability Test Condition

Premium Capacitors for Automotive Applications

Packaging Specification

Application Manual for Surface Mounting

Product Line Up (Automotive Capacitors)

Part Number	TC Code	Temperature Characteristics	Rated Voltage (Vdc)	Size L×W (mm)	Capacitance	Capacitance Tolerance	Thickness Max. (mm)
CL21B222KC6*PN □	X7R(EIA)	± 15%(-55~+125℃)	100	2.00×1.25	2.2nF	± 10%	0.70
CL21B332KC6*PN □	X7R(EIA)	± 15%(-55~+125℃)	100	2.00×1.25	3.3nF	± 10%	0.70
CL21B472KC6*PN □	X7R(EIA)	± 15%(-55~+125℃)	100	2.00×1.25	4.7nF	± 10%	0.70
CL21B682KC6*PN □	X7R(EIA)	± 15%(-55~+125℃)	100	2.00×1.25	6.8nF	± 10%	0.70
CL21B103KC6*PN □	X7R(EIA)	± 15%(-55~+125℃)	100	2.00×1.25	10nF	± 10%	0.70
CL21B153KC6*PN □	X7R(EIA)	± 15%(-55~+125℃)	100	2.00×1.25	15nF	± 10%	0.70
CL21B223KC6*PN □	X7R(EIA)	± 15%(-55~+125℃)	100	2.00×1.25	22nF	± 10%	0.70
CL21B333KCC*PN □	X7R(EIA)	± 15%(-55~+125℃)	100	2.00×1.25	33nF	± 10%	0.95
CL21B473KCC*PN □	X7R(EIA)	± 15%(-55~+125℃)	100	2.00×1.25	47nF	± 10%	0.95
CL21B683KCC*PN □	X7R(EIA)	± 15%(-55~+125℃)	100	2.00×1.25	68nF	± 10%	0.95
CL21B104KCC*PN □	X7R(EIA)	± 15%(-55~+125℃)	100	2.00×1.25	100nF	± 10%	0.95
CL21B104KCF*PN □	X7R(EIA)	± 15%(-55~+125℃)	100	2.00×1.25	100nF	± 10%	1.35
CL31B105KOP*PN □	X7R(EIA)	± 15%(-55~+125℃)	16	3.20×1.60	1.0μF	± 10%	1.25
CL31B155KOH*PN □	X7R(EIA)	± 15%(-55~+125℃)	16	3.20×1.60	1.5μF	± 10%	1.80
CL31B225KOH*PN □	X7R(EIA)	± 15%(-55~+125℃)	16	3.20×1.60	2.2μF	± 10%	1.80
CL31B105KAP*PN □	X7R(EIA)	± 15%(-55~+125℃)	25	3.20×1.60	1.0μF	± 10%	1.25
CL31B155KAH*PN □	X7R(EIA)	± 15%(-55~+125℃)	25	3.20×1.60	1.5μF	± 10%	1.80
CL31B225KAH*PN □	X7R(EIA)	± 15%(-55~+125℃)	25	3.20×1.60	2.2μF	± 10%	1.80
CL31B224KAC*PN □	X7R(EIA)	± 15%(-55~+125℃)	25	3.20×1.60	220nF	± 10%	1.00
CL31B334KAC*PN □	X7R(EIA)	± 15%(-55~+125℃)	25	3.20×1.60	330nF	± 10%	1.00
CL31B474KAC*PN □	X7R(EIA)	± 15%(-55~+125℃)	25	3.20×1.60	470nF	± 10%	1.00
CL31B684KAP*PN □	X7R(EIA)	± 15%(-55~+125℃)	25	3.20×1.60	680nF	± 10%	1.25
CL31B104KBP*PN □	X7R(EIA)	± 15%(-55~+125℃)	50	3.20×1.60	100nF	± 10%	1.25
CL31B154KBP*PN □	X7R(EIA)	± 15%(-55~+125℃)	50	3.20×1.60	150nF	± 10%	1.25
CL31B224KBP*PN □	X7R(EIA)	± 15%(-55~+125℃)	50	3.20×1.60	220nF	± 10%	1.25
CL31B334KBH*PN □	X7R(EIA)	± 15%(-55~+125℃)	50	3.20×1.60	330nF	± 10%	1.80
CL31B474KBH*PN □	X7R(EIA)	± 15%(-55~+125℃)	50	3.20×1.60	470nF	± 10%	1.80
CL21B684KOF*PN □	X7R(EIA)	± 15%(-55~+125℃)	16	2.00×1.25	680nF	± 10%	1.35
CL21B105KOF*PN □	X7R(EIA)	± 15%(-55~+125℃)	16	2.00×1.25	1.0μF	± 10%	1.35
CL21B684KAF*PN □	X7R(EIA)	± 15%(-55~+125℃)	25	2.00×1.25	680nF	± 10%	1.35
CL21B105KAF*PN □	X7R(EIA)	± 15%(-55~+125℃)	25	2.00×1.25	1.0μF	± 10%	1.35
CL31B684KBH*PN □	X7R(EIA)	± 15%(-55~+125℃)	50	3.20×1.60	680nF	± 10%	1.80
CL31B105KBH*PN □	X7R(EIA)	± 15%(-55~+125℃)	50	3.20×1.60	1.0μF	± 10%	1.80
CL31B155KBH*PN □	X7R(EIA)	± 15%(-55~+125℃)	50	3.20×1.60	1.5μF	± 10%	1.80
CL31B225KBH*PN □	X7R(EIA)	± 15%(-55~+125℃)	50	3.20×1.60	2.2μF	± 10%	1.80

*mark means design code. If you want more information, Please check with our sales representatives or product engineers.
 ※ □mark means packaging code. If you want to learn the code or quantity in detail, please see p 81.

Reliability Test Condition (Automotive Capacitors)

No	Item	Performance	Test Condition	
1	Pre-and Post-Stress Electrical Test	-		
2	High Temperature Exposure	Appearance	No abnormal exterior appearance	
		Capacitance Change	CLASS I	Within ±2.5% or 0.25pF, (Whichever is larger)
			CLASS II	Within ±10%
		Q	CLASS I	Capacitance ≥ 30pF : Q ≥ 1,000 < 30pF : Q ≥ 400 + 20 × C (C : Capacitance)
		Tanδ	CLASS II	Rated Voltage ≥ 25V : 3.0 max ≥ 16V : 5.0 max ≥ 10V : 7.5max
IR		More than 10,000 MΩ or 500 MΩ × μF (Whichever is smaller)		
3	Temperature Cycling	Appearance	No abnormal exterior appearance	
		Capacitance Change	CLASS I	Within ±2.5% or 0.25pF, (Whichever is larger)
			CLASS II	Within ±10%
		Q	CLASS I	Capacitance ≥ 30pF : Q ≥ 1,000 < 30pF : Q ≥ 400 + 20 × C (C : Capacitance)
		Tanδ	CLASS II	Rated Voltage ≥ 25V : 3.0 max ≥ 16V : 5.0 max ≥ 10V : 7.5max
IR		More than 10,000 MΩ or 500 MΩ × μF (Whichever is smaller)		
4	Destructive Physical Analysis	No defects or abnormalities	Per EIA 469	
5	Moisture Resistance	Appearance	No abnormal exterior appearance	
		Capacitance Change	CLASS I	Within ±2.5% or 0.25pF, (Whichever is larger)
			CLASS II	Within ±12.5%
		Q	CLASS I	Capacitance ≥ 30pF : Q ≥ 350 < 10pF : Q ≥ 275 + (5/2) × C < 10pF : Q ≥ 200 + 10 × C (C : Capacitance)
		Tanδ	CLASS II	Rated Voltage ≥ 25V : 3.0 max ≥ 16V : 5.0 max ≥ 10V : 7.5max
IR		More than 10,000 MΩ or 500 MΩ × μF (Whichever is smaller)		

Step	Temperature(°C)	Time(min.)
1	Min. operating Temp. ±2	15 ± 3
2	25 ± 2	1
3	Max. operating Temp. ±2	15 ± 3
4	25 ± 2	1

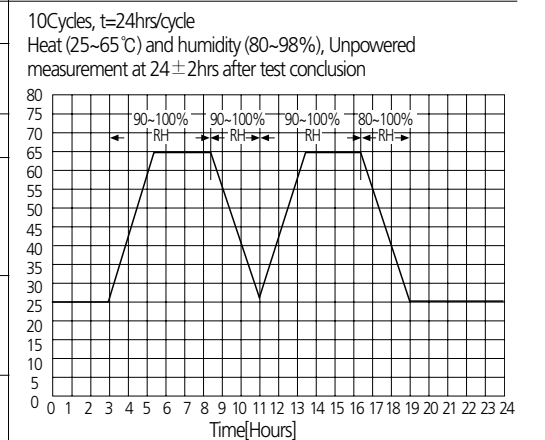

- Part Numbering System
- General Capacitors
- Ultra High Capacitors
- Super Small Capacitors
- High Voltage Capacitors
- Camera Strobe Circuit Capacitors
- Array Type Capacitors
- Low ESL Capacitors
- Reliability Test Condition
- Premium Capacitors for Automotive Applications
- Packaging Specification
- Application Manual for Surface Mounting

No	Item	Performance	Test Condition						
6	Biased Humidity	Appearance	No abnormal exterior appearance						
		Capacitance Change	CLASS I	Within ±2.5% or 0.25pF, (Whichever is larger)					
			CLASS II	Within ±12.5%					
		Q	CLASS I	Capacitance ≥ 30pF : Q ≥ 200 < 30pF : Q ≥ 100 + (10/3) × C (C : Capacitance)					
		Tanδ	CLASS II	Rated Voltage ≥ 25V : 3.5 max ≥ 16V : 5.0 max ≥ 10V : 7.5max					
IR		More than 500 μs or 25 μs × μF (Whichever is smaller)							
			1000hrs 85°C/85%RH, Rated Voltage and 1.3~1.5V, (add 100kohm resistor) Measurement at 24±2hrs after test conclusion The charge/discharge current is less than 50mA.						
7	High Temperature Operating Life	Appearance	No abnormal exterior appearance						
		Capacitance Change	CLASS I	Within ±3.0% or 0.3pF, (Whichever is larger)					
			CLASS II	Within ±12.5%					
		Q	CLASS I	Capacitance ≥ 30pF : Q ≥ 350 ≥ 10pF : Q ≥ 275 + (5/2) × C < 10pF : Q ≥ 200 + 10 × C (C : Capacitance)					
		Tanδ	CLASS II	Rated Voltage ≥ 25V : 3.5 max ≥ 16V : 5.0 max ≥ 10V : 7.5max					
IR		More than 1,000 μs or 50 μs × μF (Whichever is smaller)							
			1000hrs @ TA=125°C, 200% Rated Voltage, Measurement at 24±2hrs after test conclusion The charge/discharge current is less than 50mA.						
8	External Visual	No abnormal exterior appearance	Microscope (×10)						
9	Physical Dimensions	Within the specified dimensions	Using the calipers						
10	Mechanical Shock	Appearance	No abnormal exterior appearance						
		Capacitance Change	CLASS I	Within ±2.5% or 0.25pF, (Whichever is larger)					
			CLASS II	Within ±10%					
		Q	CLASS I	Capacitance ≥ 30pF : Q ≥ 1,000 < 30pF : Q ≥ 400 + 20 × C (C : Capacitance)					
		Tanδ	CLASS II	Rated Voltage ≥ 25V : 2.5 max ≥ 16V : 3.5 max ≥ 10V : 5.0 max					
IR		More than 10,000 μs or 500 μs × μF (Whichever is smaller)							
			Three shocks in each direction should be applied along 3 mutually perpendicular axes of the test specimen (18 shocks)						
			<table border="1"> <thead> <tr> <th>Peakvalue</th> <th>Duration</th> <th>Wave</th> </tr> </thead> <tbody> <tr> <td>1,500G</td> <td>0.5ms</td> <td>Half sine</td> </tr> </tbody> </table>	Peakvalue	Duration	Wave	1,500G	0.5ms	Half sine
Peakvalue	Duration	Wave							
1,500G	0.5ms	Half sine							

No	Item	Performance	Test Condition	
11	Vibration	Appearance	No abnormal exterior appearance	
		Capacitance Change	CLASS I	Within ±2.5% or 0.25pF, (Whichever is larger)
			CLASS II	Within ±10%
		Q	CLASS I	Capacitance ≥ 30pF : Q ≥ 1,000 < 30pF : Q ≥ 400 + 20 × C (C : Capacitance)
		Tanδ	CLASS II	Rated Voltage ≥ 25V : 2.5 max ≥ 16V : 3.5 max ≥ 10V : 5.0max
IR		More than 10,000 μs or 500 μs × μF (Whichever is smaller)		
			5g's for 20min., 12cycles each of 3 orientations, Use 8" × 5" PCB 0.031" Thick 7 secure points on one long side and 2 secure points at corners of opposite sides. Parts mounted within 2" from any secure point. Test from 10~2000Hz.	
12	Resistance to Solder Heat	Appearance	No abnormal exterior appearance	
		Capacitance Change	CLASS I	Within ±2.5% or 0.25pF, (Whichever is larger)
			CLASS II	Within ±10%
		Q	CLASS I	Capacitance ≥ 30pF : Q ≥ 1,000 < 30pF : Q ≥ 400 + 20 × C (C : Capacitance)
		Tanδ	CLASS II	Rated Voltage ≥ 25V : 2.5 max ≥ 16V : 3.5 max ≥ 10V : 5.0max
IR		More than 10,000 μs or 500 μs × μF (Whichever is smaller)		
			Solder pot : 260 ± 5°C, 10 ± 1sec.	
13	Thermal Shock	Appearance	No abnormal exterior appearance	
		Capacitance Change	CLASS I	Within ±2.5% or 0.25pF, (Whichever is larger)
			CLASS II	Within ±10%
		Q	CLASS I	Capacitance ≥ 30pF : Q ≥ 1,000 < 30pF : Q ≥ 400 + 20 × C (C : Capacitance)
		Tanδ	CLASS II	Rated Voltage ≥ 25V : 2.5 max ≥ 16V : 3.5 max ≥ 10V : 5.0max
IR		More than 10,000 μs or 500 μs × μF (Whichever is smaller)		
			-55°C/+125°C Note: Number of cycles required - 300, Maximum transfer time-20 sec, Dwell time-15min. Air-Air	
14	ESD	Appearance	No abnormal exterior appearance	
		Capacitance Change	CLASS I	Within ±2.5% or 0.25pF, (Whichever is larger)
			CLASS II	Within ±10%
		Q	CLASS I	Capacitance ≥ 30pF : Q ≥ 1,000 < 30pF : Q ≥ 400 + 20 × C (C : Capacitance)
		Tanδ	CLASS II	Rated Voltage ≥ 25V : 2.5 max ≥ 16V : 3.5 max ≥ 10V : 5.0 max
IR		More than 10,000 μs or 500 μs × μF (Whichever is smaller)		
			AEC-Q200-002	

Part Numbering System

General Capacitors

Ultra High Capacitors

Super Small Capacitors

High Voltage Capacitors

Camera Strobe Circuit Capacitors

Array Type Capacitors

Low ESL Capacitors

Reliability Test Condition

Premium Capacitors for Automotive Applications

Packaging Specification

Application Manual for Surface Mounting

No	Item	Performance	Test Condition																		
15	Solderability	95% of the terminations is to be soldered evenly and continuously	a) Preheat at 155°C for 4 hours, Immerse in solder for 5s at 245±5°C b) Steam aging for 8 hours, Immerse in solder for 5s at 245±55°C c) Steam aging for 8 hours, Immerse in solder for 120s at 260±55°C solder : a solution ethanol and rosin																		
16	Electrical Characterization	Capacitance	Within specified tolerance																		
		Q	CLASS I Capacitance ≥ 30pF : Q ≥ 1,000 < 30pF : Q ≥ 400 + 20 × C (C: Capacitance)																		
		Tanδ	CLASS II Rated Voltage ≥ 25V : 2.5 max ≥ 16V : 3.5 max ≥ 10V : 5.0 max																		
		IR@25°C	CLASS I	More than 100,000 MΩ or 1,000 MΩ × μF (Whichever is smaller)																	
			CLASS II	More than 10,000 MΩ or 500 MΩ × μF (Whichever is smaller)																	
IR@125°C	CLASS I	More than 10,000 MΩ or 100 MΩ × μF (Whichever is smaller)																			
	CLASS II	More than 1,000 MΩ or 10 MΩ × μF (Whichever is smaller)																			
Dielectric Strength		No dielectric breakdown or mechanical breakdown	I.R. should be measured with a DC voltage not exceeding Rated Voltage @25°C, @125°C for 60~120 sec. Dielectric Strength : 250% of the rated voltage for 1~5 seconds The charge/discharge current is less than 50mA.																		
17	Board Flex	Appearance	No abnormal exterior appearance																		
		Capacitance Change	CLASS I : Within ±5.0% or 0.5pF, (Whichever is larger) CLASS II : Within ±10%																		
18	Terminal Strength(SMD)	Appearance	No abnormal exterior appearance																		
		Capacitance Change	CLASS I : Within ±2.5% or 0.25pF, (Whichever is larger) CLASS II : Within ±10%																		
19	Beam Load	Destruction value should be exceed Chip Length ≤ 2.5mm a) Chip Thickness > 0.5mm : 20N b) Chip Thickness ≤ 0.5mm : 8N Chip Length ≥ 3.2mm a) Chip Thickness ≥ 1.25mm : 54.5N b) Chip Thickness < 1.25mm : 15N	Beam speed Chip Length ≤ 2.5mm, 0.5 ± 0.05mm/sec Chip Length ≥ 3.2mm, 2.5 ± 0.25mm/sec																		
20	Capacitance Temperature Characteristics	Capacitance Change	CLASS I	0 ± 30 ppm/°C																	
			CLASS II	Within ±15%																	
		Temperature Coefficient	CLASS I	0 ± 30 ppm/°C																	
			CLASS II	Within ±0.2% or 0.05pF, (Whichever is larger)																	
Capacitance Drift		CLASS I	Within ±0.2% or 0.05pF, (Whichever is larger)																		
			<table border="1"> <thead> <tr> <th>Step</th> <th>Temperature(°C)</th> <th>Time(min)</th> </tr> </thead> <tbody> <tr> <td>1</td> <td>25 ± 2</td> <td>1</td> </tr> <tr> <td>2</td> <td>Min. Operating Temp. ± 2</td> <td>15 ± 3</td> </tr> <tr> <td>3</td> <td>25 ± 2</td> <td>1</td> </tr> <tr> <td>4</td> <td>Max. Operating Temp. ± 2</td> <td>15 ± 3</td> </tr> <tr> <td>5</td> <td>25 ± 2</td> <td>1</td> </tr> </tbody> </table>	Step	Temperature(°C)	Time(min)	1	25 ± 2	1	2	Min. Operating Temp. ± 2	15 ± 3	3	25 ± 2	1	4	Max. Operating Temp. ± 2	15 ± 3	5	25 ± 2	1
Step	Temperature(°C)	Time(min)																			
1	25 ± 2	1																			
2	Min. Operating Temp. ± 2	15 ± 3																			
3	25 ± 2	1																			
4	Max. Operating Temp. ± 2	15 ± 3																			
5	25 ± 2	1																			

Cardboard Paper Tape(4mm)

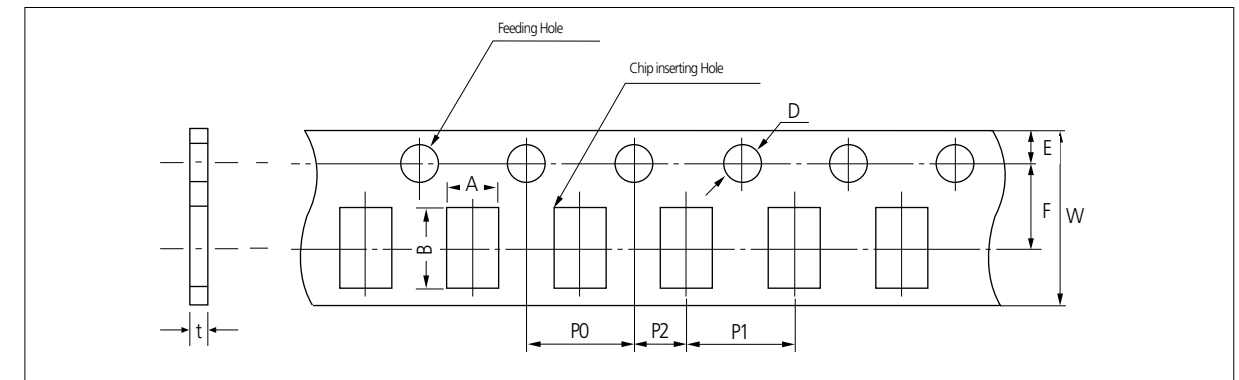

Unit: inch(mm)

Symbol	A	B	W	F	E	P1	P2	P0	D	t
0504 (1410)	1.3 ±0.2	1.7 ±0.2	8.0 ±0.3	3.5 ±0.05	1.75 ±0.1	4.0 ±0.1	2.0 ±0.05	4.0 ±0.1	Ø1.5 +0.1/-0	1.1 Below
0603 (1608)	1.1 ±0.2	1.9 ±0.2								
0805 (2012)	1.6 ±0.2	2.4 ±0.2								
1206 (3216)	2.0 ±0.2	3.6 ±0.2								

Cardboard Paper Tape(2mm)

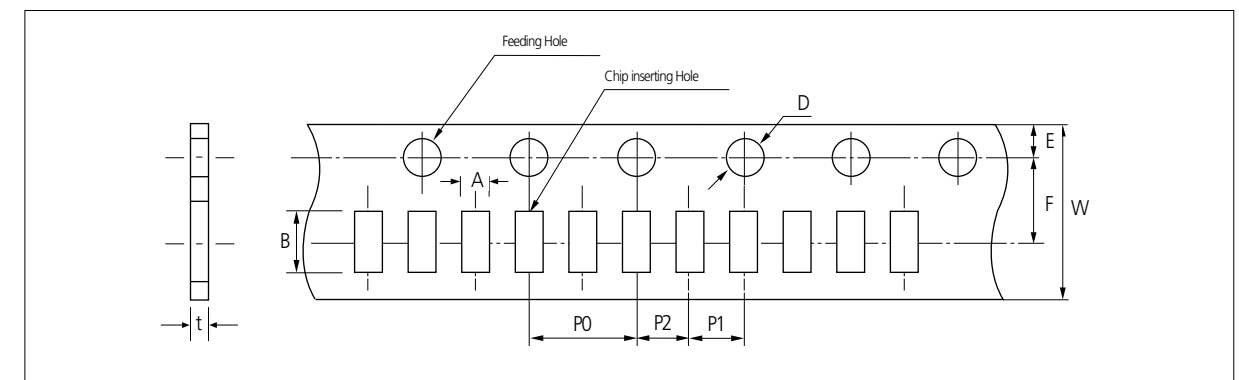

Unit: inch(mm)

Symbol	A	B	W	F	E	P1	P2	P0	D	t
01005 (0402)	0.26 ±0.03	0.46 ±0.03	8.0 ±0.3	3.5 ±0.05	1.75 ±0.05	2.0 ±0.05	2.0 ±0.05	4.0 ±0.1	Ø1.550 ±0.02	0.26 ±0.03
0201 (0603)	0.38 ±0.03	0.68 ±0.03			1.75 ±0.1	2.0 ±0.05	2.0 ±0.05	4.0 ±0.1	Ø1.5 +0.1/-0.03	0.37 ±0.03
0402 (1005)	0.62 ±0.04	1.12 ±0.04			1.75 ±0.1	2.0 ±0.05	2.0 ±0.05	4.0 ±0.1	Ø1.5 +0.1/-0.03	0.6 ±0.05
										0.37 ±0.05

Part Numbering System

General Capacitors

Ultra High Capacitors

Super Small Capacitors

High Voltage Capacitors

Camera Strobe Circuit Capacitors

Array Type Capacitors

Low ESL Capacitors

Reliability Test Condition

Premium Capacitors for Automotive Applications

Packaging Specification

Application Manual for Surface Mounting

Embossed Plastic Tape

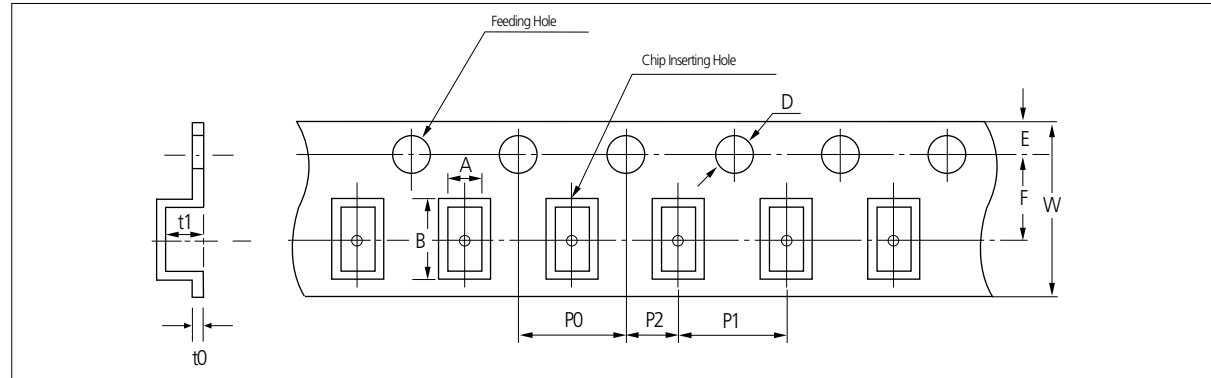

Unit: inch(mm)

Symbol Type	A	B	W	F	E	P1	P2	P0	D	t1	t0
0603 (1608)	1.05 ±0.15	1.9 ±0.15	8.0 ±0.3	3.5 ±0.05	1.75 ±0.1	4.0 ±0.1	2.0 ±0.05	4.0 ±0.1	Ø1.5 +0.1/-0	2.8 max	0.6 BELOW
0805 (2012)	1.45 ±0.2	2.3 ±0.2									
1206 0612 (3216) (1632)	1.9 ±0.2	3.5 ±0.2									
1210 (3225)	2.8 ±0.2	3.6 ±0.2									
1808 (4520)	2.3 ±0.2	4.9 ±0.2	12.0 ±0.3	5.60 ±0.05	8.0 ±0.1	3.8 max					
1812 (4532)	3.6 ±0.2	4.9 ±0.2									
2220 (5750)	5.5 ±0.2	6.2 ±0.2									

Peeling off of Cover Tape

• 5 g.f ≤ Peel off force ≤ 70 g.f

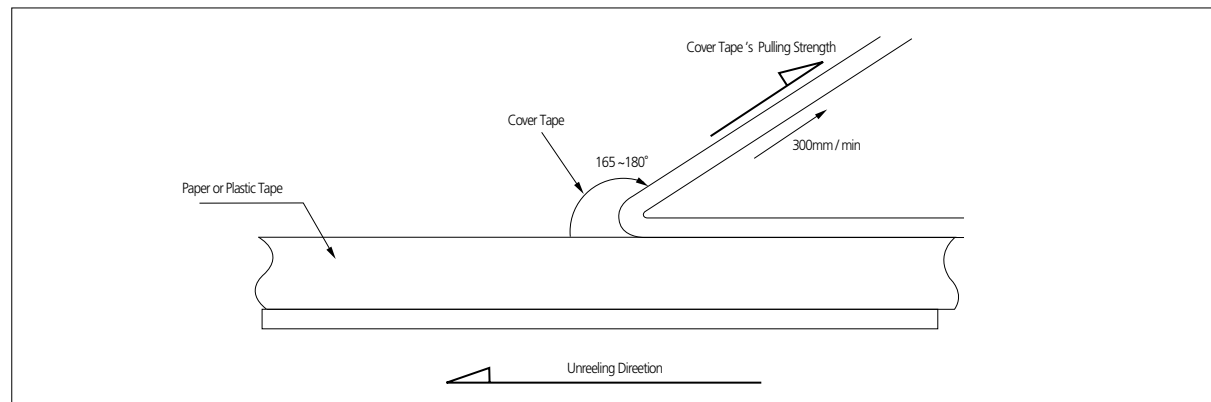

Taping Size

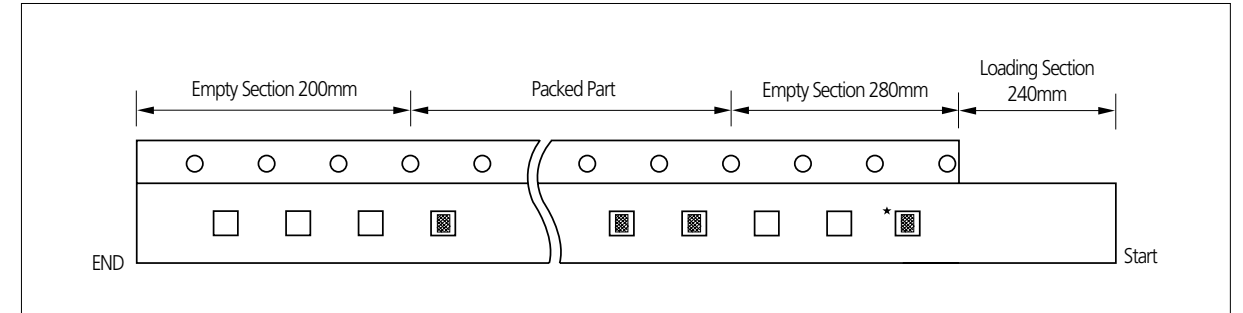

• The chip is only use for identifying the label and packaged products. Please don't use the chip.

Unit: kpcs

Size	T code	Quantity & Packing Code								
		Paper Type					Plastic Type			
		C (7"reel)	H (7"reel)	O (10"reel)	D (13"reel)	L (13"reel)	E (7"reel)	G (7"reel)	F (13"reel)	S (10"reel)
01005(0402)	2	20	-	-	-	-	-	-	-	-
0201(0603)	3	10	15	30	50	-	-	-	-	-
0402(1005)	3	10	15	30	50	-	-	-	-	-
	5	10	-	30	50	-	-	-	-	-
0504(1410)	8	4	-	10	10	15	-	-	-	-
0603(1608)	5	4	-	30	50	-	-	-	-	-
	8	4	-	10	10	15	-	-	-	-
0604(1610)	D	-	-	-	-	3	-	10	6	-
0805(2012)	A, C	4	-	10	10	15	-	-	-	-
	E, F, Q	-	-	-	-	-	2	3	10	6
1206(3216)	C	4	-	10	10	15	-	-	-	-
	E, F, P	-	-	-	-	-	2	3	10	6
	H	-	-	-	-	-	2	-	8	4
1210(3225)	9, D, C, O	-	-	-	-	-	2	-	10	-
	E, F, M	-	-	-	-	-	2	-	10	-
	H, T	-	-	-	-	-	2	-	8	4
	I, U	-	-	-	-	-	2	-	4	-
	J, V	-	-	-	-	-	1	-	4	-
	S	-	-	-	-	-	2	-	8	-
1808(4520)	F	-	-	-	-	-	2	-	-	-
1812(4532)	F, H, I	-	-	-	-	-	1	-	4	-
	L, J	-	-	-	-	-	-	-	2	-
2220(5750)	H, I, J	-	-	-	-	-	-	-	2	-

- Part Numbering System
- General Capacitors
- Ultra High Capacitors
- Super Small Capacitors
- High Voltage Capacitors
- Camera Strobe Circuit Capacitors
- Array Type Capacitors
- Low ESL Capacitors
- Reliability Test Condition
- Premium Capacitors for Automotive Applications
- Packaging Specification
- Application Manual for Surface Mounting

Reel Dimensions

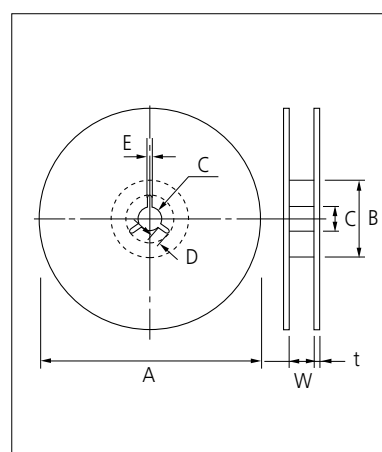

Unit: mm

Symbol	Tape Width	A	B	C	D
7" Reel	8mm	∅180+0/-3	∅60+1/-0	∅13±0.3	4±0.2
	12mm	∅180+0/-3	∅60+1/-0	∅13±0.3	4±0.2
10" Reel	8mm	∅258+0/-3	∅80+1/-0	∅13±0.3	4±0.2
	12mm	∅258+0/-3	∅80+1/-0	∅13±0.3	4±0.2
13" Reel	8mm	∅330±2.0	∅80±1.0	∅13±0.3	4±0.2
	12mm	∅330±2.0	∅80±1.0	∅13±0.3	4±0.2

Symbol	Tape Width	E	W	t
7" Reel	8mm	2.0±0.5	9±0.5	1.2±0.2
	12mm	2.0±0.5	13±0.5	1.2±0.2
10" Reel	8mm	2.0±0.5	9±0.5	1.8±0.2
	12mm	2.0±0.5	13±0.5	1.8±0.2
13" Reel	8mm	2.0±0.5	9±0.5	2.2±0.2
	12mm	2.0±0.5	13±0.5	2.2±0.2

Bulk Case Packaging

- Bulk case packaging can reduce the stock space and transportation costs.
- The bulk feeding system can increase the productivity.
- It can eliminate the components loss.

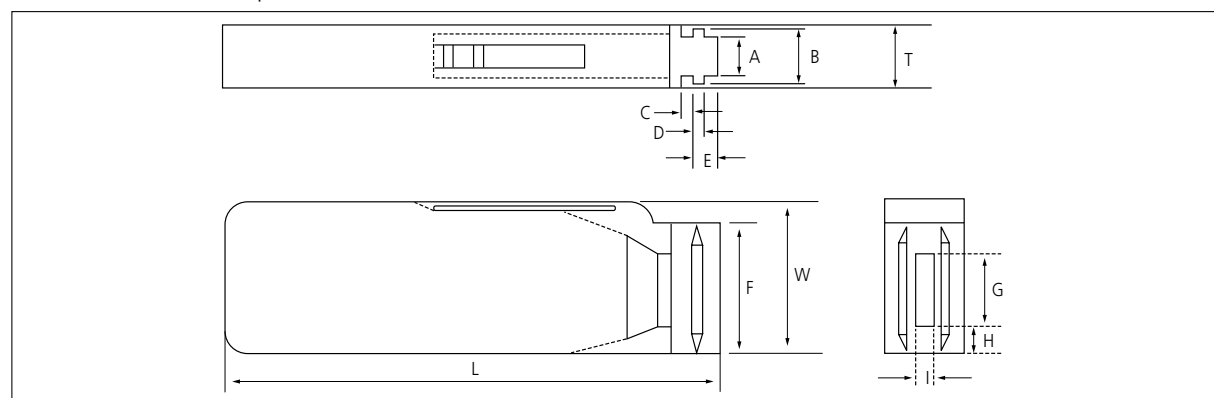

Unit: mm

Symbol	A	B	T	C	D	E
Dimension	6.8±0.1	8.8±0.1	12±0.1	1.5+0.1/-0	2+0/-0.1	3.0+0.2/-0

Symbol	F	W	G	H	L	I
Dimension	31.5+0.2/-0	36+0/-0.2	19±0.35	7±0.35	110±0.7	5±0.35

• QUANTITY

Unit: inch(mm) and pcs

Size	0402(1005)	0603(1608)	0805(2012)	
			T=0.65mm	T=0.85mm
Quantity	50,000	10,000 or 15,000	10,000	5,000 or 10,000

1.Storage of products

1-1. Storage Environment

Tape packing materials are designed to withstand long-term storage, but they will degrade more rapidly in the presence of high temperature or high humidity. Therefore, the products must be stored in an ambient 5~40°C with a relative humidity of 20~70%. Allowable storage period is within 6 months from the outgoing date of delivery.

1-2. Corrosive Gases

Since sulfur and chlorine may degrade the solderability of the end termination, it is important to store the capacitors in an environment free of these gases

1-3. Temperature Fluctuations

Since dew condensation may occur by the differences in temperature when the products are taken out of storage, it is important to maintain a temperature-controlled environment.

2. Design of Solder Land Pattern

When designing printed circuit boards, the shape and size of the solder lands must allow for the proper amount of solder on the capacitor. The amount of solder at the end terminations has a direct effect on the probability that the chip will crack. The greater amount of solder, the larger amount of stress on the chip, and the more likely that it will break. Use the following illustrations as guidelines for proper Solder land design.

Recommendation of solder Land Shape and Size

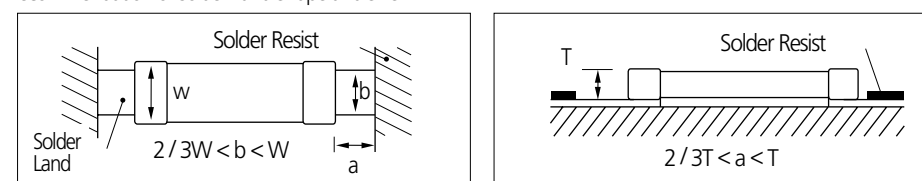

3.Adhesives

MLCCs generally require the use of an adhesive to position the chips to the circuit board prior to soldering.

3-1. Requirements for Adhesives

- They must have enough adhesion so that the chips will not fall off or move during the handling of the circuit board.
- They must maintain their adhesive strength when exposed to soldering temperatures.
- They should not spread or run when applied to the circuit board.
- They should have a long pot life.
- They should harden quickly.
- They should not corrode the circuit board or chip material.
- They should be a good insulator.
- They should be non-toxic, and not produce harmful gases, nor be harmful when touched.

3-2. Application Method

It is important to use the proper amount of adhesive. Too little will cause poor adhesion to the circuit board, and too much may strain the conductor pattern, thereby causing defective soldering. The following illustrations show the proper quantity of adhesive.

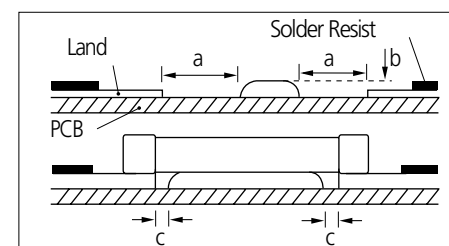

Unit: mm

Type	21	31
a	0.2min	0.2min
b	70~100µm	70~100µm
c	>0	>0

3-3. Adhesive hardening Characteristics

To prevent oxidation of the terminations, the adhesive must harden at 160 °C or less, within 2 minutes or less.

Part Numbering System

General Capacitors

Ultra High Capacitors

Super Small Capacitors

High Voltage Capacitors

Camera Strobe Circuit Capacitors

Array Type Capacitors

Low ESL Capacitors

Reliability Test Condition

Premium Capacitors for Automotive Applications

Packaging Specification

Application Manual for Surface Mounting

4. Mounting

4-1. Mounting Head Pressure

Excessive pressure will cause chip capacitors to crack. The pressure between nozzle and chip capacitor will be 300g maximum during mounting.

4-2. Bending Stress

Bending of printed circuit board by mounting head when double-sided circuit boards are used, chip capacitors first are mounted and soldered onto one side of the board. When the capacitors are mounted onto the other side, it is important to support the board as shown in the illustration. If the circuit board is not supported, it may bend, causing the already-installed capacitors to crack.

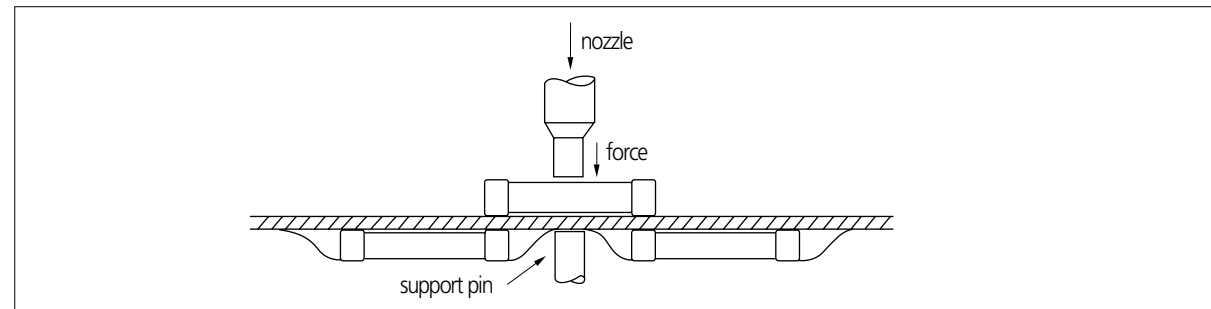

5. Flux

Although highly-activated flux gives better solderability, substances which increase activity may also degrade the insulation of the chip capacitors. To avoid such degradation, it is recommended that a mildly activated rosin flux (less than 0.2% chlorine) be used.

6. Soldering

Since a multilayer ceramic chip capacitor comes into direct contact with melted solder during soldering, it is exposed to potentially mechanical stress caused by the sudden temperature change. The capacitor may also be subject to silver migration, and to contamination by the flux. Because of these factors, soldering technique is critical.

6-1. Soldering Methods

Method	Classification	
Reflow soldering	· Overall heating	· Infrared rays · Hot plate · VPS (Vapor phase)
	· Local heating	· Air heater · Laser · Light beam
Flow Soldering	· Single wave · Double wave	

6-2. Soldering Profile

To avoid the crack problem by sudden temperature change, follow the temperature profile in the adjacent graph.

6-2-1 Pb-Free (Sn 100%) Plating

REFLOW SOLDERING

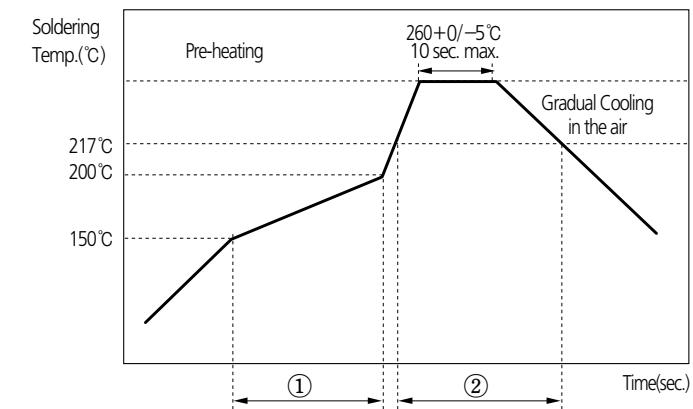

Soldering Temp. (°C)	Pre-heating Time (①, sec.)	Soldering Time (②, sec.)
260+0/-5°C	60~120	60~150

FLOW SOLDERING

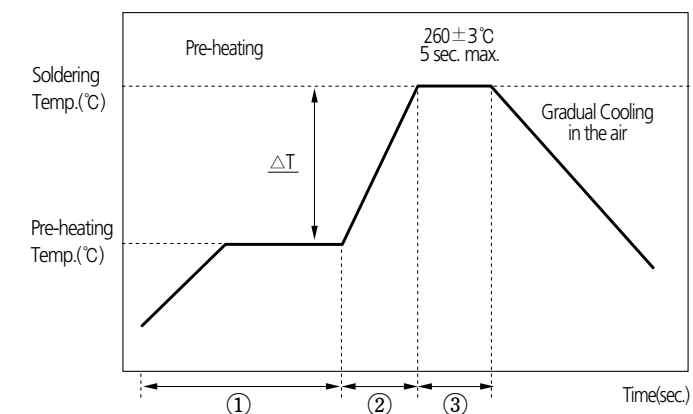

ΔT (°C)	Soldering Temp. (°C)	Pre-heating Time (①+②, sec.)	Soldering Time (③, sec.)
≤ 150 (1206 and below size)	260±3	≥ 120	≤ 5

SOLDER IRON (Hand Soldering)

Variation of Temp. (°C)	Soldering Temp. (°C)	Pre-heating Time (sec.)	Soldering Time (sec.)	Cooling Time (sec.)	Condition of Iron Facilities		
					Wattage	Tip Diameter	Soldering Time
ΔT ≤ 130	300 ± 10°C max.	≥ 60 sec.	≤ 4 sec.	-	20W max.	3mm max.	4 sec max.

※ Caution - Iron tip should not contact with ceramic body directly

Part Numbering System

General Capacitors

Ultra High Capacitors

Super Small Capacitors

High Voltage Capacitors

Camera Strobe Circuit Capacitors

Array Type Capacitors

Low ESL Capacitors

Reliability Test Condition

Premium Capacitors for Automotive Applications

Packaging Specification

Application Manual for Surface Mounting

6-3. Manual Soldering

Manual soldering can pose a great risk of creating thermal cracks in chip capacitors. The hot soldering iron tip comes into direct contact with the end terminations, and operator's carelessness may cause the tip of the soldering iron to come into direct contact with the ceramic body of the capacitor. Therefore the soldering iron must be handled carefully, and close attention must be paid to the selection of the soldering iron tip and to temperature control of the tip.

6-4. Amount of Solder

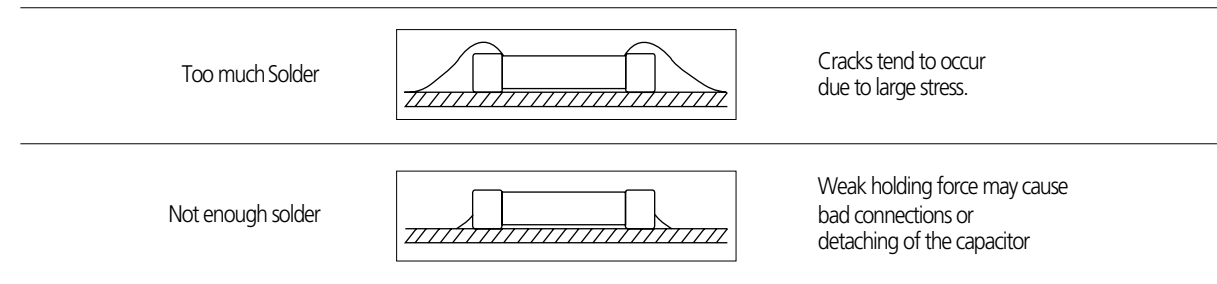

6-5. Cooling

Natural cooling using air is recommended. If the chips are dipped into solvent for cleaning, the temperature difference (ΔT) must be less than 100°C

6-6. Cleaning

If rosin flux is used, cleaning usually is unnecessary. When strongly activated flux is used, chlorine in the flux may dissolve into some types of cleaning fluids, thereby affecting the chip capacitors. This means that the cleaning fluid must be carefully selected, and should always be new.

7. Notes for Separating Multiple, Shared PC Boards

A multi-PC board is separated into many individual circuit boards after soldering has been completed. If the board is bent or distorted at the time of separation, cracks may occur in the chip capacitors. Carefully choose a separation method that minimizes the bending of the circuit board.



Quality System Certification List

Table 1: Certification list of Samsung Factory

	SUWON(KOREA)	BUSAN(KOREA)	PHILIPPINES	TIANJIN(CHINA)	High Tech(China)
ISO / TS 16949	BSI TS 91430-000	BSI TS 91430-001	BSI TS 508248	—	—
Date	2007 - 11 - 23		2006 - 08 - 17	—	—
Validity	~ 2010 - 11 - 22		~ 2009 - 08 - 16	—	—
ISO 9001 (Product)	—	—	—	UL A14044	UL A14044
Date	—	—	—	2006 - 08 - 09	2006 - 08 - 09
Validity	—	—	—	~ 2009 - 08 - 09	~ 2009 - 08 - 09
TL 9000 (Product)	—	BSI FM 90588	—	—	—
Date	—	2008 - 09 - 22	—	—	—
Validity	—	~ 2011 - 08 - 21	—	—	—
ISO 14001	BSI EMS 66454	BSI EMS 77354	CCC1 02107E10192R3L	CCC1 02106E10082R1L	
Date	2007 - 10 - 09	2006 - 07 - 06	2007 - 07 - 24	2006 - 04 - 25	
Validity	~ 2010 - 06 - 10	~ 2009 - 07 - 05	~ 2010 - 07 - 23	~ 2009 - 04 - 24	
OSHAS 18001	BSI OHS 54743	SGS PH08/-22-	CCC1 02106S10146R1L	CCC1 02106S10046R16	
Date	2006 - 07 - 10	~ 2008 - 03 - 17	2006 - 09 - 06	2006 - 04 - 25	
Validity	~ 2009 - 07 - 09	~ 2011 - 03 - 16	~ 2009 - 09 - 05	~ 2009 - 04 - 24	