

# 2 POSITION LIGHT-N-LOK MODULAR LATCHED CONNECTOR

## Compact Connector with Modular Technology

TE Connectivity (TE) introduces the 2 Position LIGHT-N-LOK Modular Latched Connector. This connector utilizes poke-in termination which supports easy field installation as no tools are required. The compact design makes this connector ideal for applications where space is a constraint. Suitable for indoor lighting applications, this connector comes in four different colors and one modular design enabling ease of identification and assembly.

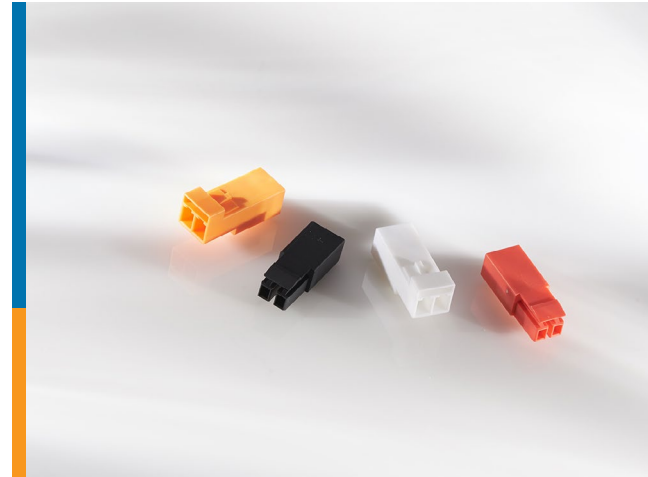

## Applications

- Indoor lighting

## Electrical

- **Current rating:**
  - 16 AWG: UL2459 @ 600V 5A; UL1977 @ 600V - 8A
  - 18 AWG: UL2459 @ 600V 5A; UL1977 @ 600V - 8A
  - 22 AWG: UL2459 @ 600V 3A; UL1977 @ 600V - 3A
- **Voltage rating:** 600 VAC Max.
- **Dielectric strength:** 2200 VAC

## Mechanical

- **Operating Temperature:** -40°C to +105°C
- **Durability:** 10 cycles

## Specifications

- **Application Specification:** [114-137159](#)
- **Product Specification:** [108-137159](#)
- **UL1977 Approval** E28476
- **UL2459 Approval** E308110
- **Multi-pole Splicing Wire Connectors**
- **Multi-pole Splicing Wire Connectors Certified for Canada**

## Materials

- **Housing:** PA, UL94 V-0
- **Contact:** Copper Alloy with Tin plating









## Key Benefits

- Modular Technology enables flexibility in design
- Tool free, easy and fast installation with poke-in contact feature
- Compact size design for space saving
- Color configurations enables easy identification

## Colors

- Black
- Orange
- Red
- White

## Product Selection Information

Type	Description	Color	Part Number	
	Plug	2 Position Latched Poke-In Wire-to-Wire Connector	Natural	<a href="#">2834048-1</a>
	Receptacle	2 Position Latched Poke-In Wire-to-Wire Connector	Natural	<a href="#">2834049-1</a>
	Plug	2 Position Latched Poke-In Wire-to-Wire Connector	Black	<a href="#">2834048-2</a>
	Receptacle	2 Position Latched Poke-In Wire-to-Wire Connector	Black	<a href="#">2834049-2</a>
	Plug	2 Position Latched Poke-In Wire-to-Wire Connector	Orange	<a href="#">2834048-3</a>
	Receptacle	2 Position Latched Poke-In Wire-to-Wire Connector	Orange	<a href="#">2834049-3</a>
	Plug	2 Position Latched Poke-In Wire-to-Wire Connector	Red	<a href="#">2834048-4</a>
	Receptacle	2 Position Latched Poke-In Wire-to-Wire Connector	Red	<a href="#">2834049-4</a>

Type	Description	Color	Part Number	
	Modular Receptacle	2 Position Latched Poke-In Wire-to-Wire Connector	Natural	<a href="#">1-2834049-1</a>
	Modular Receptacle	2 Position Latched Poke-In Wire-to-Wire Connector	Black	<a href="#">1-2834049-2</a>
	Modular Receptacle	2 Position Latched Poke-In Wire-to-Wire Connector	Orange	<a href="#">1-2834049-3</a>
	Modular Receptacle	2 Position Latched Poke-In Wire-to-Wire Connector	Red	<a href="#">1-2834049-4</a>

## Dimensions

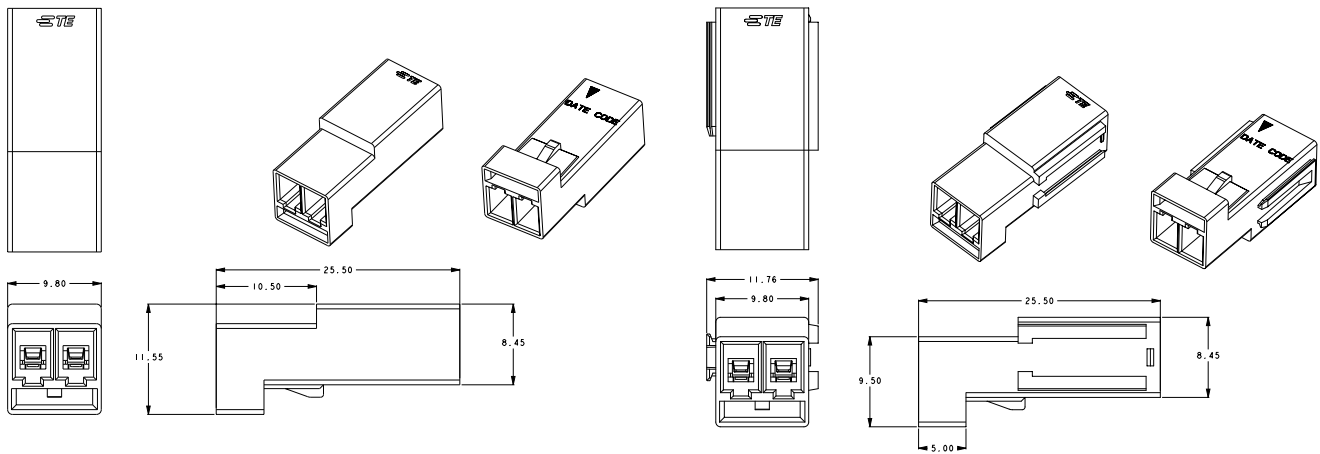

### te.com

© 2017 TE Connectivity Ltd. Family of Companies. All Rights Reserved. LIGHT-N-LOK, TE, TE Connectivity, and the TE connectivity (logo) are trademarks of the TE Connectivity Ltd. family of companies. Other logos, product and Company names mentioned herein may be trademarks of their respective owners.  
1-1773886-4 JN 3/2017

USA: +1 (800) 522-6752  
Canada: +1 (905) 475-6222  
Mexico: +52 (0) 55-1106-0800  
Latin/S. America: +54 (0) 11-4733-2200  
Germany: +49 (0) 6251-133-1999

UK: +44 (0) 800-267666  
France: +33 (0) 1-3420-8686  
The Netherlands: +31 (0) 73-6246-999  
China: +86 (0) 400-820-6015

# Mouser Electronics

Authorized Distributor

Click to View Pricing, Inventory, Delivery & Lifecycle Information:

## TE Connectivity:

[2834049-4](#) [1-2834049-2](#) [2834049-3](#) [2834049-2](#) [1-2834049-4](#) [2834049-1](#) [2834048-3](#) [1-2834049-3](#) [2834048-2](#) [1-2834049-1](#) [2834048-1](#) [2834048-4](#)