

# Surface Mount Digital Step Attenuator

## DAT-31R5A+ Series

50Ω 0 to 31.5 dB, 0.5 dB Step DC to 4.0 GHz

### The Big Deal

- Wideband, operates up to 4 GHz
- Immune to latchup
- High IP3, 52 dBm



CASE STYLE: DG983-2

### Product Overview

The DAT-31R5A+ series of 50Ω digital step attenuators provides adjustable attenuation from 0 to 31.5 dB in 0.5 dB steps. The control is a 6-bit serial/parallel interface, and the attenuators operate with either single positive or dual (positive and negative) supply voltage. DAT-31R5A+ series models are produced by a unique CMOS process on silicon, offering the performance of GaAs with the advantages of conventional CMOS devices.

### Key Features

Feature	Advantages
Wideband operation, specified from DC to 4.0 GHz	Can be used in multiple applications such as communications, satellite and defense, reducing part count.
Serial or parallel interface	Models available with serial or parallel interface mode to suit customer demand.
Good VSWR, 1.2:1 typ.	Eases interfacing with adjacent components and results in low amplitude ripple.
Single positive supply models: (Model suffixes: -SN+ and -PN+) +2.3 to +3.6V+	Use of single positive supply simplifies power supply design. An internal negative voltage generator supplies the desired negative voltage. Single positive supply results in excellent spurious performance, -140 dBm typical.
Dual supply models: (Model suffixes: -SN+ and -PN+) +2.7 to +3.6V (Positive) and -3.6 to -3.2V (Negative)	Dual supply provides spurious-free operation. It also allows fast switching up to 1 MHz (vs. 25 kHz for single supply).
Useable over a wide range of supply voltages, +2.3/2.7 to 5.2V	Wide range of positive operating voltages allows the DAT-31R5A+ Series of models to be used in a wide range of applications. See Application Note AN-70-006 for operation above +3.6V
Footprint compatible to DAT-31R5-XX+ Series (XX=SN/SP/PN/PP)	Can fit into existing footprint and provide wideband performance, to 4 GHz instead of 2.4 GHz.
Safe attenuation transitions	The DAT-31R5A-XX+ series is designed to prevent any momentary positive 'spikes' in power during attenuation transitions



# Digital Step Attenuator

50Ω DC-4000 MHz

31.5 dB, 0.5 dB Step

6 Bit, Serial control interface, Single Supply Voltage

## Product Features

- Immune to latch up
- Excellent accuracy, 0.1 dB Typ
- Serial control interface
- Low Insertion Loss
- High IP3, +52 dBm Typ
- Very low DC power consumption
- Excellent return loss, 20 dB Typ
- Small size 4.0 x 4.0 mm



*Generic photo used for illustration purposes only*

## DAT-31R5A-SP+

CASE STYLE: DG983-2

## Typical Applications

- Base Station Infrastructure
- Portable Wireless
- CATV & DBS
- MMDS & Wireless LAN
- Wireless Local Loop
- UNII & Hiper LAN
- Power amplifier distortion canceling loops

### +RoHS Compliant

*The +Suffix identifies RoHS Compliance. See our web site for RoHS Compliance methodologies and qualifications*

## General Description

The DAT-31R5A-SP+ is a 50Ω digital step attenuator that provides adjustable attenuation of 0 to 31.5 dB in 0.5 dB steps. The control is a 6-bit serial interface, operating with a single (positive) supply voltage. DAT-31R5A-SP+ is produced by a unique CMOS process on silicon, offering the performance of GaAs with the advantages of conventional CMOS devices.

## Simplified Schematic

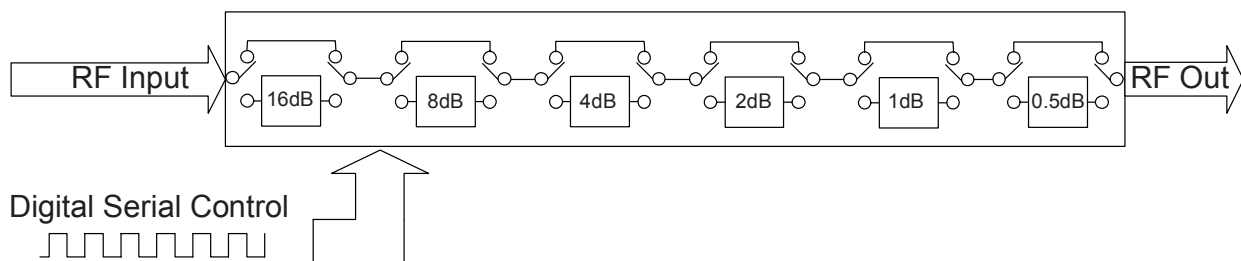

## RF Electrical Specifications<sup>(Note 1)</sup>, DC-4000 MHz, T<sub>AMB</sub>=25°C, V<sub>DD</sub>=+3V

Parameter	Freq. Range (GHz)	Min.	Typ.	Max.	Units
Accuracy @ 0.5 dB Attenuation Setting	DC-1	—	0.03	0.1	dB
	1-2.4	—	0.05	0.15	
	2.4-4	—	0.07	0.2	
Accuracy @ 1 dB Attenuation Setting	DC-1	—	0.02	0.1	dB
	1-2.4	—	0.05	0.15	
	2.4-4	—	0.1	0.25	
Accuracy @ 2 dB Attenuation Setting	DC-1	—	0.05	0.15	dB
	1-2.4	—	0.15	0.25	
	2.4-4	—	0.15	0.35	
Accuracy @ 4 dB Attenuation Setting	DC-1	—	0.07	0.2	dB
	1-2.4	—	0.15	0.25	
	2.4-4	—	0.23	0.5	
Accuracy @ 8 dB Attenuation Setting	DC-1	—	0.03	0.2	dB
	1-2.4	—	0.15	0.5	
	2.4-4	—	0.6	0.8	
Accuracy @ 16 dB Attenuation Setting	DC-1	—	0.1	0.3	dB
	1-2.4	—	0.15	0.7	
	2.4-4	—	1.1	1.45	
Insertion Loss <sup>(note 2)</sup> @ all attenuator set to 0dB	DC-1	—	1.3	1.9	dB
	1-2.4	—	1.6	2.4	
	2.4-4	—	2.1	3.0	
Input IP3 <sup>(note 3)</sup> (at Min. and Max. Attenuation)	DC-4	—	+52	—	dBm
Input Power @ 0.2dB Compression <sup>(Note 3)</sup> (at Min. and Max. Attenuation)	DC-4	—	+24	—	dBm
Input Operating Power	10 kHz to 50 MHz	—	—	See Fig. 1	dBm
	>50 MHz	—	—	+24	
VSWR	DC-1	—	1.2	1.5	:1
	1-2.4	—	1.2	1.6	
	2.4-4	—	1.4	1.9	

### Notes:

1. Tested on Evaluation Board TB-334, See Figure 3.
2. Insertion loss values are de-embedded from test board Loss (test board's Insertion Loss: 0.10dB @ 100MHz, 0.35dB @ 1000MHz, 0.60dB @ 2400MHz, 0.75dB @ 4000MHz).
3. Input IP3 and 1dB compression degrade below 1 MHz. Input power not to exceed max operating specification for continuous operation.

## DC Electrical Specifications

Parameter	Min.	Typ.	Max.	Units
V <sub>DD</sub> , Supply Voltage	2.3	3	3.6 <sup>(Note 4)</sup>	V
I <sub>DD</sub> Supply Current	—	—	200	µA
Control Input Low	-0.3	—	+0.6	V
Control Input High	1.17	—	3.6	V
Control Current	—	—	20 <sup>(Note 5)</sup>	µA

4. For operation above +3.6V, see Application Note AN-70-006
5. Except, 30µA typ for C0.5, C16 at +3.6V

## Absolute Maximum Ratings<sup>(Note 6,7)</sup>

Parameter	Ratings
Operating Temperature	-40°C to 105°C
Storage Temperature	-65°C to 150°C
V <sub>DD</sub>	-0.3V Min., 5.5V Max.
Voltage on any control input	-0.3V Min., 3.6V Max.
Input Power	+30dBm
Thermal Resistance	37°C/W

6. Permanent damage may occur if any of these limits are exceeded.
7. Operation between max operating and absolute max input power will result in reduced reliability.

## Switching Specifications

Parameter	Min.	Typ.	Max.	Units
Switching Speed, 50% Control to 0.5dB of Attenuation Value	—	1.0	—	µSec
Switching Control Frequency	—	—	25	kHz

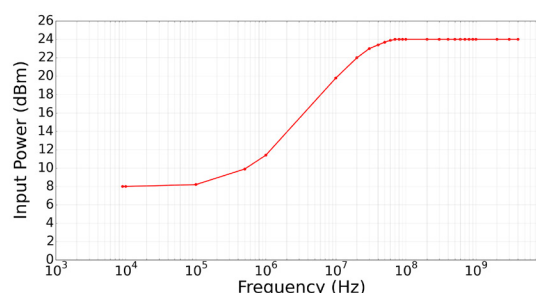

Figure 1. Max Input Operating Power vs Frequency

# Digital Step Attenuator

# DAT-31R5A-SP+

## Pin Description

Function	Pin Number	Description
C16	1	Control for Attenuation bit, 16dB (Notes 3,4,6)
RF in	2	RF in port (Note 1)
Data	3	Serial Interface data input (Note 3)
Clock	4	Serial Interface clock input
LE	5	Latch Enable Input (Note 2)
V <sub>DD</sub>	6	Positive Supply Voltage
N/C	7	Not connected
N/C	8	Not connected
V <sub>DD</sub>	9	Positive Supply Voltage
GND	10	Ground connection
GND	11	Ground connection
GND	12	Ground connection (Note 7)
V <sub>DD</sub>	13	Positive Supply Voltage (Note 8)
RF out	14	RF out port (Note 1)
C8	15	Control for attenuation bit, 8 dB (Note 4)
C4	16	Control for attenuation bit, 4 dB (Note 4)
C2	17	Control for attenuation bit, 2 dB (Note 4)
GND	18	Ground Connection
C1	19	Control for attenuation bit, 1 dB (Note 4)
C0.5	20	Control for attenuation bit, 0.5 dB (Note 4,6)
GND	Paddle	Paddle ground (Note 5)

### Notes:

- Both RF ports must be held at 0VDC or DC blocked with an external series capacitor.
- Latch Enable (LE) has an internal 2MΩ to internal positive supply voltage.
- Place a 10KΩ resistor in series, as close to pin as possible to avoid freq. resonance.
- Refer to Power-up Control Settings.
- The exposed solder pad on the bottom of the package (See Pin configuration) must be grounded for proper device operation.
- This pin has an internal 200 kΩ resistor to ground.
- Ground must be less than 80 mil (0.08") from pin 12 proper device operation.
- When V<sub>DD</sub> ≤ 3.6V this pin may be connected directly to V<sub>DD</sub>, when 3.6V < V<sub>DD</sub> ≤ 5.2V need to use a voltage divider to reduce voltage on this pin to a voltage in the range +1.17 to 3.6V. See Application note AN-70-006.

## Pin Configuration (Top View)

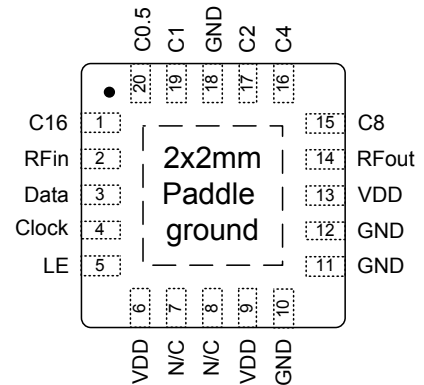

## Device Marking

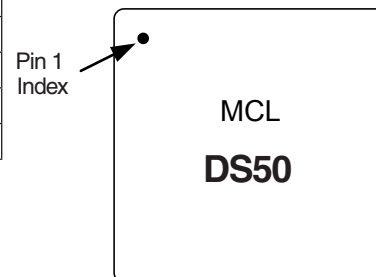

## Simplified Schematic

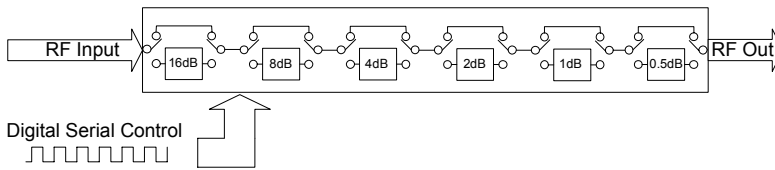

The DAT-31R5A-SP+ serial interface consists of 6 control bits that select the desired attenuation state, as shown in Table 1: Truth Table

Attenuation State	C16	C8	C4	C2	C1	C0.5
Reference	0	0	0	0	0	0
0.5 (dB)	0	0	0	0	0	1
1 (dB)	0	0	0	0	1	0
2 (dB)	0	0	0	1	0	0
4 (dB)	0	0	1	0	0	0
8 (dB)	0	1	0	0	0	0
16 (dB)	1	0	0	0	0	0
31.5 (dB)	1	1	1	1	1	1

Note: Not all 64 possible combinations of C0.5 - C16 are shown in table

The serial interface is a 6-bit serial in, parallel-out shift register buffered by a transparent latch. It is controlled by three CMOS-compatible signals: Data, Clock, and Latch Enable (LE). The Data and Clock inputs allow data to be serially entered into the shift register, a process that is independent of the state of the LE input.

The LE input controls the latch. When LE is HIGH, the latch is transparent and the contents of the serial shift register control the attenuator. When LE is brought LOW, data in the shift register is latched.

The shift register should be loaded while LE is held LOW to prevent the attenuator value from changing as data is entered. The LE input should then be toggled HIGH and brought LOW again, latching the new data. The timing for this operation is defined by **Figure 2** (Serial Interface Timing Diagram) and **Table 2** (Serial Interface AC Characteristics).

**Figure 2: Serial interface Timing Diagram**

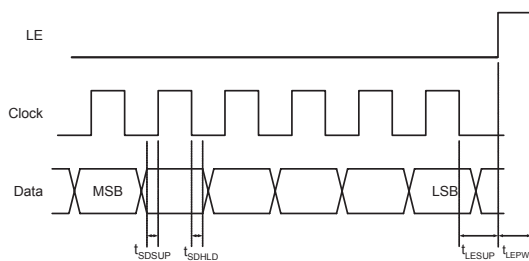

**Table 2. Serial Interface AC Characteristics**

Symbol	Parameter	Min.	Max.	Units
$f_{clk}$	Serial data clock frequency (Note 1)		10	MHz
$t_{clkH}$	Serial clock HIGH time	30		ns
$t_{clkL}$	Serial clock LOW time	30		ns
$t_{LESUP}$	LE set-up time after last clock falling edge	10		ns
$t_{LEPW}$	LE minimum pulse width	30		ns
$t_{SDSUP}$	Serial data set-up time before clock rising edge	10		ns
$t_{SDHLD}$	Serial data hold time after clock falling edge	10		ns

Note 1.  $f_{clk}$  verified during the functional pattern test. Serial programming sections of the functional pattern are clocked at 10MHz to verify  $f_{clk}$  specification.

The DAT-31R5A-SP+, uses a common 6-bit serial word format, as shown in **Table 3**: 6-Bit attenuator Serial Programming Register Map.

The first bit, the MSB, corresponds to the 16 dB Step and the last bit, the LSB, corresponds to the 0.5 dB step.

<b>Table 3. 6-Bit attenuator Serial Programming Register Map</b>					
B5	B4	B3	B2	B1	B0
C16	C8	C4	C2	C1	C0.5



MSB  
(first in)



LSB  
(last in)

### Power-up Control Settings

The DAT-31R5A-SP+ always assumes a specifiable attenuation setting on power-up, allowing a known attenuation state to be established before an initial serial control word is provided.

When the attenuator powers up, the six control bits are set to whatever data is present on the six data inputs (C0.5 to C16).

This allows any one of the 64 attenuation settings to be specified as the power-up state.

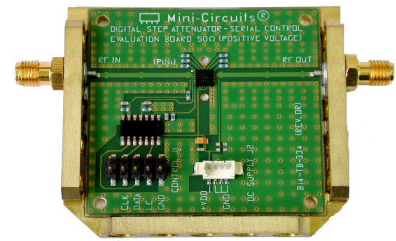
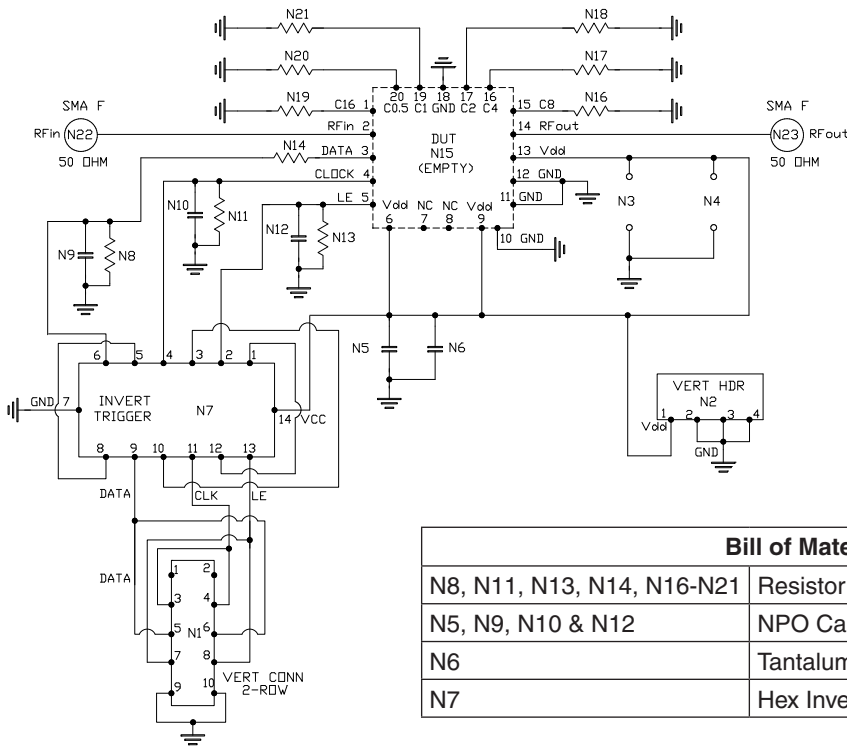

**TB-334**

Bill of Materials	
N8, N11, N13, N14, N16-N21	Resistor 0603 10 KOhm +/- 1%
N5, N9, N10 & N12	NPO Capacitor 0603 100pF +/- 5%
N6	Tantalum Capacitor 0805 100nF +/- 10%
N7	Hex Invert Schmitt Trigger MSL1

**Notes**

1. Both RF ports must be held at 0VDC or DC blocked with an external series capacitor.
2. Test Board TB-334 is designed for operation for VDD=2.3 to 3.6V. For operation over 3.6V to 5.2V, See Application Note AN-70-006
3. VDD=Vdd

**Fig 3. Evaluation Board Schematic, TB-334, used for characterization (DUT not soldered on TB-334)**

**Test Equipment**

- For Insertion Loss, Isolation and Return Loss:**  
Agilent's E5071C Network Analyzer & E3631A Power Supply.
- For Compression:**  
Agilent's N9020A Signal Analyzer, E8247C RF Generator, E3631A Power Supply & U2004A Power Sensor.
- For Input IP3:**  
Agilent's N9020A Signal Analyzer, N5181A Signal Generators, E3631A Power Supply, U2004A Power Sensor.
- For Spurs:**  
Agilent N5181A Signal Generator, E4440A Spectrum Analyzer.
- For Switching Time:**  
Agilent's N5181A Signal Generator, 81110A Pulse Generator, 54832B Oscilloscope, E3631A Power Supply.
- For Max Control Frequency:**  
Agilent's N5181A Signal Generator, N9020A Signal Analyzer, E3631A Power Supply, 81110A Pulse Generator.

**Measurement Conditions**

- For Insertion Loss, Isolation and Return Loss:**  
VDD=+2.3/+3/+5.5V & Pin=0dBm
- For Compression:** Pin=0/+24dBm. VDD=+3V
- For Input IP3:** Pin=+10dBm/tone.  
Tone spacing: 0.1 MHz to 1 MHz RF Freq and 1 MHz to 4200 MHz RF Freq, VDD=+3V
- For Spurs:** RF IN at 1000MHz and -20dBm. VDD=+3V
- For Switching Time:**  
RF Freq=501MHz/0dBm, Pulse for LE=1Hz/0/+3.4V, Delay=500ms, Width=500ms. VDD=+3V
- For Max Control Frequency:**  
RF Freq=501MHz, 0dBm. VDD=+3V

Additional Detailed Technical Information	
<i>additional information is available on our dash board. To access this information <a href="#">click here</a></i>	
<b>Performance Data</b>	Data Table
	Swept Graphs
	S-Parameter (S2P Files) Data Set (.zip file)
<b>Case Style</b>	DG983-2 <i>Plastic package, exposed paddle, lead finish: NiPdAu</i>
<b>Tape &amp; Reel</b> Standard quantities available on reel	F87 <i>7" reels with 20, 50, 100 or 200 devices</i> <i>13" reels with 3K devices</i>
<b>Suggested Layout for PCB Design</b>	PL-182
<b>Evaluation Board</b>	TB-334
<b>Environmental Ratings</b>	ENV33T1

## ESD Rating

Human Body Model (HBM): Class 1C (1000 to <2000V) in accordance with MIL-STD-883 method 3015

## MSL Rating

Moisture Sensitivity: MSL1 in accordance with IPC/JEDEC J-STD-020D

## MSL Test Flow Chart



## Additional Notes

- Performance and quality attributes and conditions not expressly stated in this specification document are intended to be excluded and do not form a part of this specification document.
- Electrical specifications and performance data contained in this specification document are based on Mini-Circuit's applicable established test performance criteria and measurement instructions.
- The parts covered by this specification document are subject to Mini-Circuits standard limited warranty and terms and conditions (collectively, "Standard Terms"); Purchasers of this part are entitled to the rights and benefits contained therein. For a full statement of the Standard Terms and the exclusive rights and remedies thereunder, please visit Mini-Circuits' website at [www.minicircuits.com/MCLStore/terms.jsp](http://www.minicircuits.com/MCLStore/terms.jsp)