

Control
number



2008-10E-046

SPECIFICATION	
LITHIUM BATTERY	
Ordering Code :	CR-2032L/BN
Model Code :	CR2032

Approved by
Division/Department
Name
Title
Signature/date

ISSUED
Oct,29,2008
PT. Panasonic Gobel
Energy Indonesia

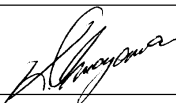
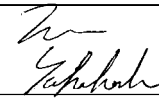
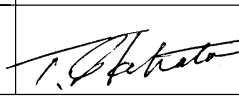
Established date : Oct,29,2008
PT. Panasonic Gobel Energy Indonesia

Approved	Checked	Checked	Drafted
			

Revision history

No .	Date	Revision
1	Oct,29,2008	Established
2		
3		
4		
5		
6		
7		
8		
9		
10		
11		
12		
13		
14		
15		
16		
17		
18		

1. Applicable range

This specification applies to manganese dioxide lithium batteries which are delivered to from PT. Panasonic Gobel Energy Indonesia

2. Nominal specification

- 2.1. Model number (bare cell) CR2032
- 2.2. Nominal voltage 3V
- 2.3. Nominal capacity 225 mAh
- 2.4. Operation temperature From -30 to 60
(Please consult Panasonic in case continuous high-temperature usage conditions)
- 2.5. Recommendable storage condition Temperature : 5 to 35 Humidity : 45 ~ 85%RH
- 2.6. Mass Refer to drawing 1
- 2.7. Dimension Refer to drawing 1
- 2.8. Battery composition Lithium primary battery composed of cathode from manganese dioxide anode from lithium and electrolyte from organic solvent and lithium salt.

3. Battery characteristics

Table 1. CR2032 characteristics

	Items	Test method	Temperature		initial	After 1 year in room temperature
1	Open circuit voltage	Voltage between terminals (Min)	20 +/- 2		3.1 V	3.1 V
2	Internal resistance	1kHz sine wave method (Max.)	20 +/- 2		20	-
3	Discharge duration	Continuous discharge (Std.)	20 +/- 2	Load : 15k cut off V : 2.0V	1183h	1133h
		Continuous discharge (Min.)			1041h	1019h

4. Indication

4.1. Below items are indicated on battery or its package

- Model code CR2032
- Nominal voltage 3V
- Plus polarity +
- Manufacturer or its brand : Panasonic
- Production country Made in Indonesia
- (Design of indication can be changed without notice)

4.2. Production date

- Stated on minus side of battery
- First digit: End digit of dominical year; Second digit; Month (October=O, November=Y, December=Z)
- Example : 7Z(December/2007)

4.3. UL

This battery is certificate by UL and listed on file number MH12210

4.4 Production Site

PT. Panasonic Gobel Energy Indonesia, Jl. Teuku Umar Km. 44, Cikarang Barat Bekasi, Jawa Barat Indonesia

Drawing 1. Dimensions

Ordering code : CR2032

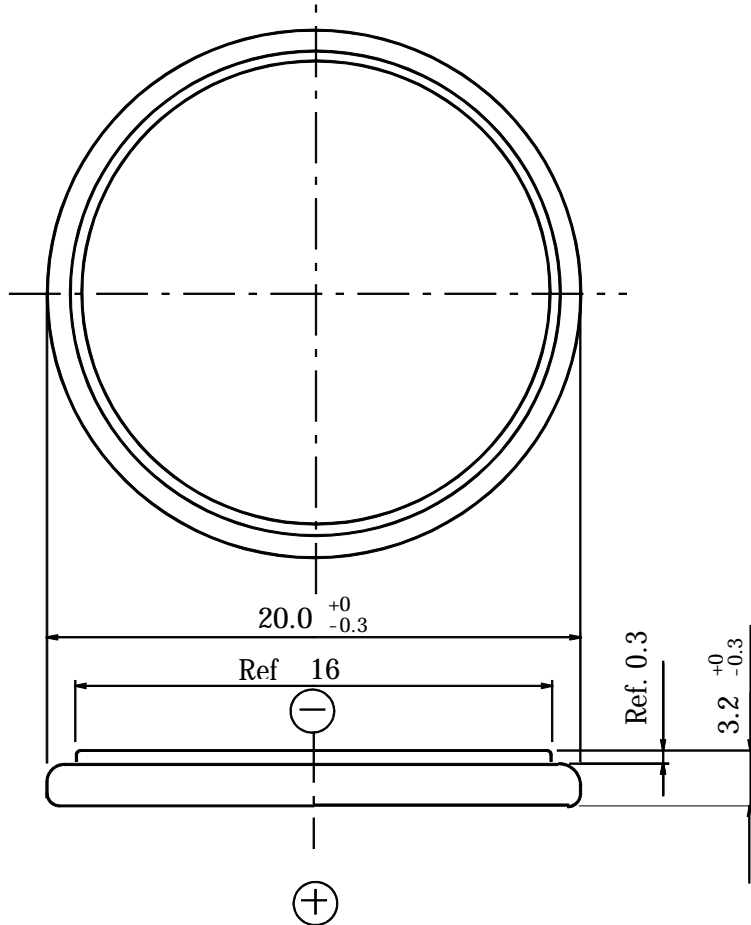

Terminal : Plus terminal material : Nickel plated stainless steel
Minus terminal material : Nickel plated stainless steel

Mass : Approx. 2.9 g

PT. Panasonic Gobel Energy Indonesia

5. Test condition and performance

5.1. External dimensions

This shall be measured with caliper described in item 6.3.(1). Do not short cells by caliper.

Dimensions should confirm to drawing 1.

5.2. Open circuit voltage

After storage in measuring atmosphere at least 2 hours, this shall be measured with voltage meter described in item 6.3.(2). Open circuit voltage should conform to table 1.

5.3. Internal resistance

After storage in measuring atmosphere at least 2 hours, this shall be measured with resistance meter described in item 6.3.(3).

Internal resistance should conform to table 1.

5.4. Discharge duration

After storage in measuring atmosphere at least 8 hours, batteries are discharged by load resistance described in table 1. Discharge is time from initial until reaching closed circuit voltage described in table 1. Discharge duration should conform to table 1.

5.5. Anti-leakage

After 42 cycles of thermal cycle test by below condition, battery should not have deformation or leakage by visual inspection.

* This test should start from high temperature (60) position.

* No moisture should be added to room temperature and humidity environment.

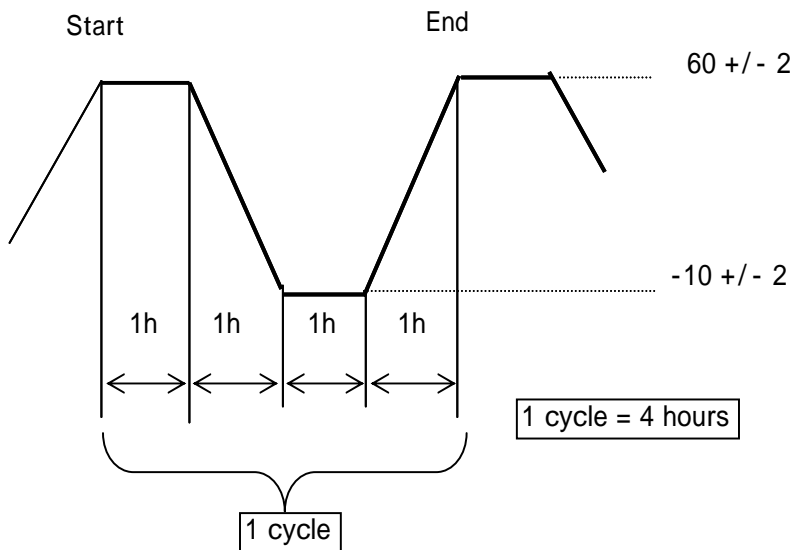

5.6. Storage characteristics

(1) Open circuit voltage

After storage term described on table 1, sample batteries should be storage in measuring atmosphere at least 4 hours. Then open circuit voltage should be measured with voltage meter described in item 4.3.(2). This should conform to table 1.

(2) Internal resistance

After storage term described on table 1, sample batteries should be storage in measuring atmosphere at least 4 hours. Then internal resistance should be measured with resistance meter described in item 4.3.(3). This should conform to table 1.

(3) Discharge duration

After storage term described on table 1, sample batteries should be storage in measuring atmosphere at least 8 hours. Then batteries are discharged by load resistance described in table 1. is time from initial until reaching closed circuit voltage described in table 1. Discharge duration should conform to values described in table 1.

5.7. Appearance

No deformation, bruise and stain which cause practical interference.

6. Test conditions

- 6.1. Initial test Initial test must be done within 2 months from delivery.
- 6.2. Temperature and humidity Unless otherwise specified, test should be carried out in room temperature (20 +/- 15) and room humidity (65 +/- 20%RH).

6.3. Measuring equipment's

(1) Dimension

Micrometer defined by JIS B7502 or equivalent or more accurate one must be used for dimension measurement.

For one digit decimals tolerance, caliper with 0.05mm accuracy which is defined JIS B7507 or higher accuracy equipment must be used.

(2) Voltage

Voltage meter defined by JIS C1102 class 0.2 or higher, and more than 10Mohm impedance must be used.

(3) Internal resistance

It should be measured by sinusoidal current method (1kHz). Measurement should be finished within 5 seconds.

(As a general, Agilent Technologies LCRmeter 4263B or equivalent should be used.)

(4) Load resistance includes all resistance of discharge circuit, and tolerance is less than 0.5%.

(5) Visual inspection is carried out by naked eyes.

7. Operation and modification of this specification

Modification must be carried out after the prior mutual agreement.

Any accidents caused by non-described items in this specifications must be discussed and solved mutually.

8. Important Notes (Warranty)

- 1) The batteries are warranted to conform to the description contained in this specifications for a period of twelve [12] months from the ex-factory date and any claim by customer (apparatus manufacturer or distributor) must be made within such period. During that warranty period, if the batteries are proved to become defective, non-defective and conforming batteries will be supplied in due course at sole expense of PECGI upon PECGI's own determination that this is apparently caused by negligence of PECGI.
- 2) Confirm and assure the matching and reliability of batteries on actual set or unit application with customer's responsibility.
- 3) PECGI shall not warrant or be responsible in any case where customer fails to carry out proper handling, operating, installation, testing, service and checkout of the batteries and/or to follow the instruction, cautions, warnings, notes provided in this specifications, or other PECGI's reasonable instructions or advise.
- 4) This product specification will be validated assuming that it is accepted when it is not returned within six months from the date of issue.

9. Precautions for use

9.1 Cautions for storage

- Store the battery at a constant temperature of 35 degree C or less in order to prevent deteriorations from heat.
- Keep the battery away from high humidity such as 85% RH or higher in order to prevent dew condensations on the battery that may cause to electrical leakage,
- Keep the battery away from heat sources i.e., boiler, radiator and etc., and from direct sunlight.

9.2 Warning for safety

Following cautions should be taken into consideration in order to use this battery in safe, since the battery contains combustible materials such as Lithium metal and organic electrolyte.

- Do not use except in applicable model or equipment.
- Do not mix fresh and used batteries.
- Do not mix different types (chemistries) of batteries.
- Do not short circuit.
- Do not charge.
- If multiple batteries are kept in contact with each other. The (+) and (-) terminals may short-circuit, and/or the charging possibly happen by other adjacent batteries, which may cause of shorten service life, significant damages and catching fire.
- Do not dispose into fire.
- Do not heat up higher than 100 .
- Do not solder direct to battery.
- Do not disassemble.
- Do not soak in water.
- Do not deform.
- Do not apply inadequacy modifications or remodeling on the batteries.
- Insert the batteries in the correct polarity position.

Warning for prevention of ingestion accident

- Small-sized batteries can easily be swallowed. They must be kept out of the reach of small children.
- Also, in the design of equipment using batteries, the care should be taken to ensure that batteries are NOT easy removable for children.

9.3 Caution for better usage

- Use gold-plated or nickel-plated steel or stainless steel strips for terminals in order to keep good conductivity with the battery surface. Terminals made of gold-plated phosphor bronze will ensure stable conductivity.
- Apply and keep the contact pressure more than 2N for stable conductivity.
- Before inserting batteries, check the terminal contact surfaces on both the equipment and the batteries are clean, and also check that they are not deformed. If the contact surfaces are dirty, clean up and dry them thoroughly before inserting batteries.
- Even if batteries of the same size or same shape, they may differ in type or grade. When replacing batteries, confirm that they are correct type by checking the identification symbol (designated by I.E.C. standards) which is marked on the battery and its packages.
- Lithium primary batteries continuously indicate high voltage even toward the end of their service life. As such, they may be mistakenly judged as yet being strong. In case of multiple batteries are used in an application or equipment, all batteries should be replaced at the same time when the one of those batteries shows it has totally consumed even other batteries seems still operating, since the remaining capacity in other batteries must be also quite little at the time.
- When multiple batteries are used in series in applications or equipments, it may occur that the one battery has a polarity inversion at the end of operation life. That behavior happen when the battery had consumed its capacity earlier than other batteries. Therefore, that is not failure of battery.
- When the Lithium battery has short-circuit, even slightly. A certain amount of time is required for recovering its voltage completely. If the electrical characteristics of the battery are

measured at a time before a sufficient time has passed, it may indicate unstable values due to the battery was in recovering mode.

- If the battery touch with any antistatic conductive materials include packing bags, trays, mats, sheets, films and resin cases, sheets, for example, have a resistance of 10^3 to 10^6 , it may cause of short-circuit since both the positive and the negative terminal of the battery may contact with those materials. In order to prevent short circuit, special attention may apply when handle batteries or battery attached PCB in close to those materials.

Notice for equipment design

- Keep batteries away from heat source or flame, and water.
- Please contact us in case of using multiple batteries.

S P E C I F I C A T I O N

Precautions for Use

Please pay attention to the following points in order to maintain satisfactory operating conditions.

- * Use nickel plated (steel or stainless steel) for power terminal contacts.
- * To ensure stable contact, the contact pressure for power terminals must be at least 50 grams.
- * When measuring battery voltage, use a meter with an internal resistance of 1 MΩ or greater. Correct voltage measurements cannot be obtained otherwise.
- * Batteries are extremely sensitive to the adverse effects of humidity. Be sure to store them in a place which is dry and subject to little temperature change.
- * Do not place near the boiler or radiator, nor expose to the direct sunlight.
- * If button-type batteries are kept in contact with each other, the (+) and (-) terminals may short-circuit, greatly shortening their serviceable life.
- * Button-type batteries may expand slightly during use. Therefore, sufficient space must be provided for this expansion when designing equipment.
- * Before inserting batteries, check to confirm that the terminal contact surfaces on both the equipment and the batteries are clean and that they are not deformed. If the contact surfaces are dirty, clean and dry them thoroughly before inserting batteries.
- * Batteries of the same size and shape may differ in type and grade. When exchanging batteries, confirm that they are the correct type by checking the identification symbol (designated by I.E.C. standards) provided on the battery.
- * Alkaline primary batteries continue to register high voltage even toward the end of their serviceable life. As such, they may be mistakenly judged as yet being strong. If one of several batteries being used in a set is found to be exhausted, it can be assumed that there is very little life remaining in the others even though they may continue to register high voltage. It is therefore advisable to exchange all of the batteries at the same time.
- * The direction of polarity in a battery may reverse as it nears the end of its serviceable life. This occurs when it is the first among several batteries being used in a set to be exhausted. It is not due to an abnormality in the battery itself.
- * When a lithium battery is short-circuited, even slightly, a certain amount of time is required for its voltage output to recover completely. If the electrical characteristics of the battery are measured before a sufficient amount of time has passed, the battery may appear to be malfunctioning when actually it is merely in a state of recovery.

The batteries should be used correctly, otherwise the set may be damaged due to leakage trouble. Therefore, keep the following precautions in mind.

- * Do not charge, short-circuit, disassemble, heat or dispose the batteries in fire.
- * Insert the batteries in correct polarity position.
- * Do not directly solder to batteries.
- * Do not use spent batteries with new ones.

Small-sized batteries can easily be swallowed. They must be kept out of the reach of small children. Also, in the design of battery powered equipment, care should be taken to ensure that batteries cannot be easily removed by children.

3		
2		
1		
Sym.	Date of Revision	Remarks
Date of stipulation	Stipulated	Described
May . 4. 1984		<i>H. Hattori</i>

Battery Safety Practices

Avoid danger when handling batteries

Lithium batteries contain volatile materials such as lithium, organic solvents and other chemical ingredients. Incorrect handling of lithium batteries may result in heat generation, fire or explosion, with the risk of personal injury or damage. To prevent accidents when handling batteries, be sure to observe the following precautions.

1. Do not stack or jumble batteries

Avoid contact between positive (+) and negative (-) battery poles, and contact with other metal surfaces, as this can cause short circuits with intense current flows and heat. Stacking or jumbling batteries, as shown at right, may cause short circuits, heat generation, fire or explosion.

Example of stacked and jumbled batteries



* Contact between battery poles may form a discharge circuit and lead to heat generation, fire or explosion.

2. Do not dispose of batteries in fire

Disposal of batteries in fire is extremely dangerous with a risk of explosion and violent flaring.

3. Do not heat batteries

When lithium batteries are heated above 100°C (212°F), the resin used in seals, separators and other parts may be damaged, causing electrolyte leaks and internal short circuits which may lead to fire or explosion.

Enlargement

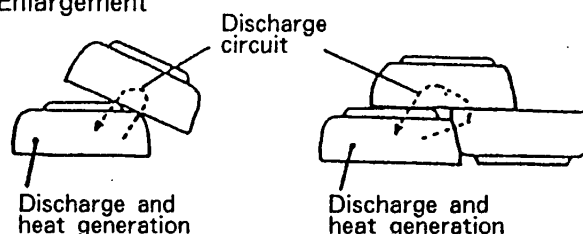

4. Do not Solder directly onto batteries

Heat from soldering may damage seals, separators and other parts, causing electrolyte leaks and internal short circuits which may lead to fire or explosion.

5. Do not recharge batteries

Attempting to recharge batteries may result in internal generation of gases, which may lead to swelling, fire or explosion.

6. Do not disassemble batteries

Do not disassemble lithium batteries as this can generate a gas that may irritate the throat. Lithium may also react with moisture to generate heat and fire.

7. Do not deform batteries

When extreme pressure is applied to batteries, seals may be deformed or damaged, causing electrolyte leaks or internal short circuits. This may lead to the risk of heat generation, fire or explosion.

8. Do not mix different types of batteries

For some applications, mixing different types of batteries, or new and old batteries, can cause over discharge due to differences in voltage and electrical capacities. This may lead to the risk of swelling or explosion.

9. Insert batteries correctly

Depending on the application device, incorrect insertion of batteries, with positive (+) and negative (-) poles reversed, may result in short circuits and the risk of heat generation, fire or explosion.

Please ensure the above precautions are strictly observed by related divisions including production departments, sales departments and external subcontractors. For additional details and information, please contact our sales representatives.

Beware of Antistatic Conductive Materials

Whenever terminal-mounted backup batteries or coin-type lithium batteries contact conductive materials, they discharge. Measures to protect semiconductor parts from static damage have been implemented in plants that use such ICs and LSIs. A number of protective materials are presently being used, and all contain blends of carbon, aluminum and other metals that make them conduct.

Antistatic conductive materials include packing bags, trays, mats, sheets, film and resin cases. Sheets, for example, have a resistance of 10^3 to $10^6 \Omega$, which means that when they contact the positive and negative terminals of a battery, they will discharge the battery.

In a lithium battery, a current flow of several μA to several mA reduces its voltage and electrical capacity. We recommend constant attention when using batteries around protective materials.

Examples

A terminal-mounted battery with its terminals inserted into a conductive mat is completely discharged after several days.

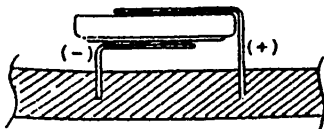

Conductive mat

A PCB-mounted battery is completely discharged by contact with the conductive resin case.

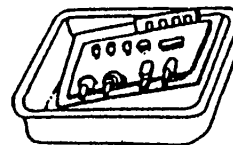

Conductive resin case

PCB-mounted batteries are discharged by contact with spacers and conductive rubber sheets.

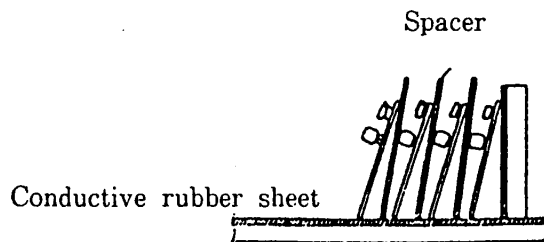

Conductive rubber sheet

Batteries left on a work bench with positive and negative terminals in direct contact with the grounded rubber sheet cover are completely discharged.

Ground wire
Conductive sheet

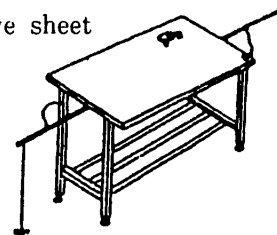

For more information, please make contact with your local dealer.

Preventing Accidental Memory Erasure

Coin-type Lithium batteries are widely used for memory backup purposes. However, there have been an increasing number of cases of accidental memory erasure due to inadequate battery contact.

To prevent unexpected memory erasure, consider the following tips for proper use.

< Long-term Continuous Battery Use >

- Use a battery with solderable tab terminals, so that the battery can be permanently soldered to terminal pads on the circuit board (Fig. 1).
- If the battery requires periodic replacement, use a battery holder (Fig. 2) or a battery with in-line lead connectors (Fig. 3).

The battery holder can be adjusted to suit any Panasonic lithium battery (Fig. 2).

< Batteries Requiring Short-Term Periodic Replacement --- Using batteries without solderable tab terminals or lead connectors >

- Use gold- or nickel-plated steel or stainless-steel strips for battery terminal contacts. Terminals made of gold-plated phosphor bronze will ensure contact with long-term stability.
- Y-shaped terminals (double contacts) for both the anode and cathode offer very stable contact (Fig. 4).

Each contact on the Y-shaped terminals requires a minimum contact pressure of 2-10N {approximately 200~1000gf} (Fig. 5).

- To guard against momentary contact failures of a few milliseconds in duration, use the tantalum capacitor-diode-resistor circuit shown in Fig. 6.
- * Do not touch the contact surfaces of the battery with bare hands, as this will increase the contact resistance and impair proper contact.

Figures 1 through 6 show examples of how to ensure proper battery contact.

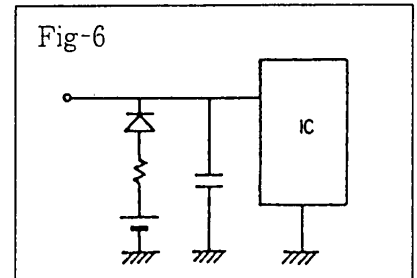
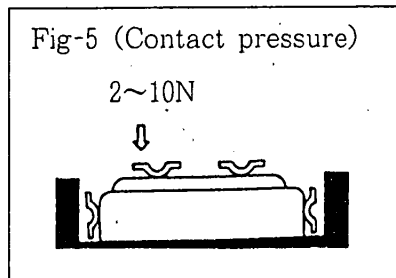
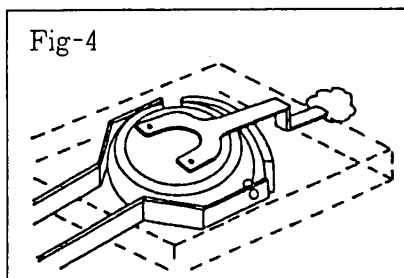
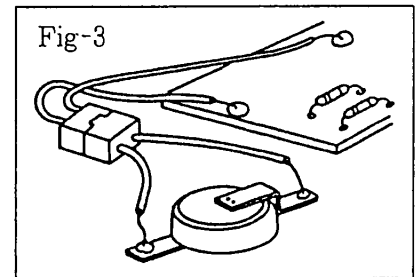
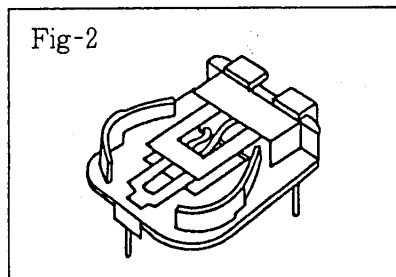
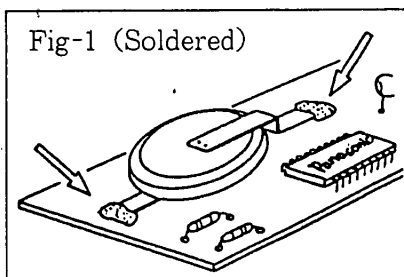

For more information, please make contact with your local dealer.