

SMD Reflective Optical Sensor

OPB9000



Features

- Market leading 25k+ lux ambient light immunity
- Programmable output configuration and sensitivity level
- Single-command calibration with on-chip EEPROM
- Temperature compensated LED drive
- 6 μ s response time
- Pulsed synchronous drive-detection
- Surface mount package
- Small dimensions: L 4.0mm x W 2.2mm x H 1.46mm
- -40°C to +85°C operating temperature range
- 2.7V to 5.5V supply voltage
- Ideal for industrial and medical applications

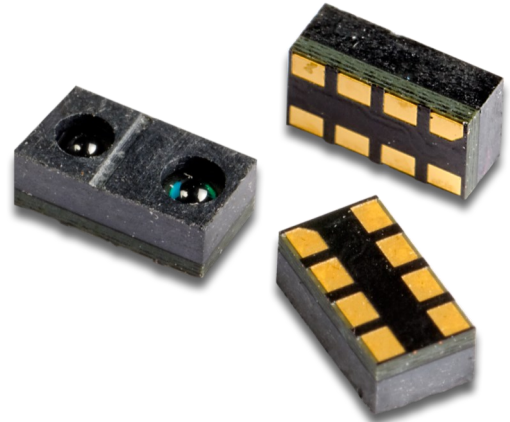

Description

The OPB9000 is a versatile sensor that can be used in a wide variety of industrial and medical applications. The sensor features market-leading ambient light immunity which allows operation from dark rooms to bright sunlight. It can detect various types of media with as little as a 30% change in reflectivity. Robust, industrial grade resin allows the sensor to operate at a wide temperature range from -40C to + 85C, ideal for the harshest environments.

Factory calibrated to a white card at a 12mm distance to offer plug and play detection, the OPB9000 can be re-calibrated in a matter of milliseconds with a single command for specific application requirements. Integrated automatic temperature compensation maximizes detection consistency and reliability. The small footprint saves valuable PCB real estate as devices become smaller and more portable.

The OPB9000 eliminates the need for peripheral circuitry like op-amps, data converters, and comparators, as all analog signal conditioning is integrated in the IC.

Applications

- All non-contact position sensing and presence detecting applications
- Industrial printing and high-speed paper detection
- Manufacturing and automation
- Automated banking machines
- Hospital and lab equipment
- Portable medical equipment
- Automatic dispensing
- Material handling and asset tracking

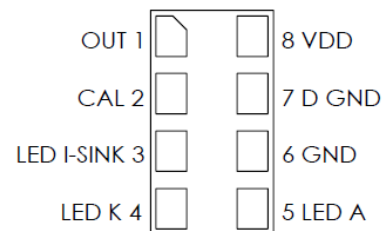

Ordering Information

Part Number	Packaging	Quantity
OPB9000	Tape and reel	2500 per reel

General Note

TT Electronics reserves the right to make changes in product specification without notice or liability. All information is subject to TT Electronics' own data and is considered accurate at time of going to print.

TT Electronics | OPTEK Technology
1645 Wallace Drive, Carrollton, TX 75006 | Ph: +1 972 323 2200
www.ttelectronics.com | www.optekinc.com

Recommended Application Circuit

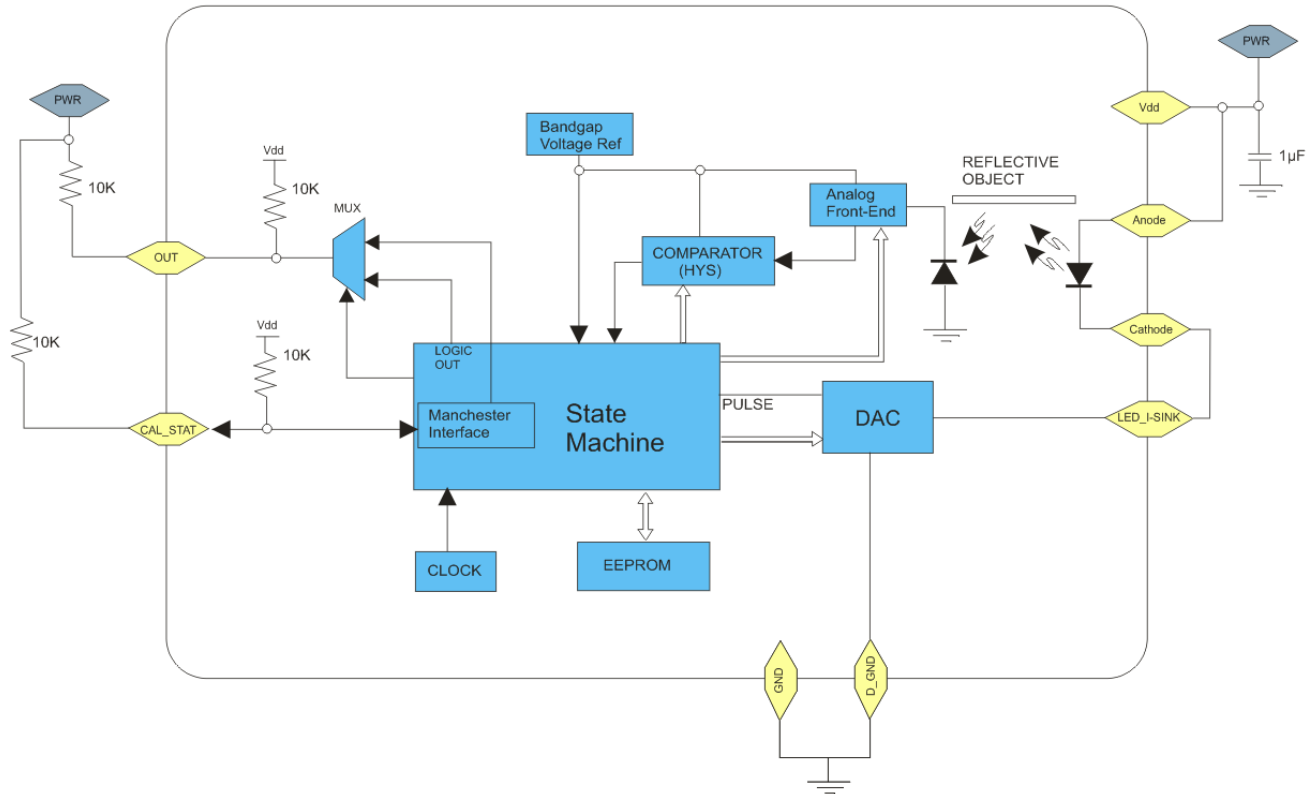

Pin	Name	Function/Description
1	OUT	Logic output, also used as digital output to read register bits
2	CAL_STAT	Calibrate input / status output (to verify successful calibration)
3	LED I-SINK	LED current sink (connect to LED cathode)
4	CATHODE	LED cathode (connect to LED I-SINK pin)
5	ANODE	LED anode—connect to VDD
6	GND	Ground—connect to D_GND
7	D_GND	Digital ground—connect to ground
8	V _{DD}	Positive supply power input

General Note

TT Electronics reserves the right to make changes in product specification without notice or liability. All information is subject to TT Electronics' own data and is considered accurate at time of going to print.

TT Electronics | OPTEK Technology
 1645 Wallace Drive, Carrollton, TX 75006 | Ph: +1 972 323 2200
www.ttelectronics.com | www.optekinc.com

Electrical Specifications

Absolute Maximum Ratings ($T_A = 25^\circ\text{C}$ unless otherwise noted)			
Parameter	Symbol	Maximum	Units
DC supply voltage	V_{DD}	6	V
Voltage on any pin with respect to GND		[-0.5, 6]	V
Voltage on any pin with respect to V_{DD}		[-6, +0.5]	V
Current into or out of any pin other than GND, cathode		± 20	mA
Current into or out of GND, cathode		± 150	mA
Illuminance / background light	I_x	25	kLux
ESD immunity (human body model)	ESD	± 4 HBM; contact discharge	kV
Operating temperature range	T_{OPR}	-40°C to +85°C	
Storage temperature range	T_{STG}	-40°C to +105°C	

Note: Permanent damage to the device may occur if operated outside the Absolute Maximum specifications. Proper function and reliability of the device at these or any other conditions outside the Recommended Operating Conditions may also be adversely affected

General Note

TT Electronics reserves the right to make changes in product specification without notice or liability. All information is subject to TT Electronics' own data and is considered accurate at time of going to print.

TT Electronics | OPTEK Technology
1645 Wallace Drive, Carrollton, TX 75006 | Ph: +1 972 323 2200
www.ttelectronics.com | www.optekinc.com

Electrical Specifications (cont.)

Electrical Characteristics ($T_A = 25^\circ\text{C}$ unless otherwise noted)

SUPPLY CHARACTERISTICS

#	PARAMETER	SYM	CONDITIONS	MIN	NOM	MAX	UNIT	NOTES
1	Supply voltage	V_{DD}		2.7		5.5	V	
2	Supply current—active	I_{DDA}	[OP,DS] = 'b01; [CA] = 'b1			4.2	mA	1
3	Supply current (including LED drive)	I_{DD}	[OP,DS] = 'b01; [CA] = 'b1			16	mA	
4	Supply voltage ripple immunity	ΔV_{DDpp}	Sinusoidal; $f \leq 10\text{ kHz}$	$.02 * V_{DD}$			V	16
5	Wake-up time	t_{WU}				32	ms	2

LED I-SINK PIN CHARACTERISTICS

#	PARAMETER	SYM	CONDITIONS	MIN	NOM	MAX	UNIT	NOTES
6	LED pulsed drive current	$I_{OL:K:MAX}$	Maximum [LED] value; $V_{DD} - V(K) \leq 2V$		85		mA	
7	LED pulsed drive current	$I_{OL:K:MIN}$	Minimum [LED] value; $V_{DD} - V(K) \leq 2V$		3		mA	
8	LED pulse period	t_{PER}			2		μs	
9	LED pulse duty cycle	DC_{PW}			12.5%			
10	LED pulse settling time	$t_{S:K}$				100	ns	3

OUT PIN CHARACTERISTICS

#	PARAMETER	SYM	CONDITIONS	MIN	NOM	MAX	UNIT	NOTES
11	Output low voltage (OUT pin)	$V_{OL:OUT}$	$I_{OL} = 4\text{mA}$; [OP,DS] = 'b01; [CA] = 'b1; photodiode DARK			0.4	V	
12	Output high voltage (OUT pin)	$V_{OH:OUT}$	$I_{OH} = -4\text{mA}$; [OP,DS] = 'b11; [CA] = 'b1; photodiode DARK	$V_{DD} - 1$			V	
13	Leakage current (OUT pin)	$I_{L:OUT}$	[OP,DS] = 'b10; [CA] = 'b1; $V(\text{OUT}) = V_{DD} = 5.5V$; photodiode DARK			1	μA	
14	Pullup resistance (OUT pin)	$R_{P:OUT}$	[OP,DS] = 'b10; [CA] = 'b1; $V(\text{OUT}) = 0$; photodiode DARK	6.1		19.1	$\text{K}\Omega$	
15	Read output bit time	t_{ROB}	First two bits to be read are 'b0, 'b1	5		20	μs	4
16	Read output delay time	t_{ROD}	[OP,DS] = 'b10; [CA] = 'b1; photodiode DARK; LSB to be read is 'b1			6	μs	5
17	Optical response time	t_{OR}			6	6.5	μs	6

General Note

TT Electronics reserves the right to make changes in product specification without notice or liability. All information is subject to TT Electronics' own data and is considered accurate at time of going to print.

TT Electronics | OPTEK Technology
1645 Wallace Drive, Carrollton, TX 75006 | Ph: +1 972 323 2200
www.ttelectronics.com | www.optekinc.com

Electrical Specifications (cont.)

Electrical Characteristics ($T_A = 25^\circ\text{C}$ unless otherwise noted)								
CAL PIN CHARACTERISTICS								
#	PARAMETER	SYM	CONDITIONS	MIN	NOM	MAX	UNIT	NOTES
18	Output low voltage (CAL pin)	$V_{OL:CAL}$	$I_{OL} = 4\text{ mA}$; STATUS or WRITE mode			0.4	V	
19	Leakage current (CAL pin)	$I_{L:CAL}$	OPERATION mode; $V(CAL) = V_{DD} = 5.5\text{V}$			1	μA	
20	Pullup resistance (CAL pin)	$R_{P:CAL}$	OPERATION mode; $V(CAL) = 0\text{V}$	5.5		18.2	$\text{k}\Omega$	
21	Input low voltage (CAL pin)	$V_{IL:CAL}$				$0.3 * V_{DD}$	V	
22	Input high voltage (CAL pin)	$V_{IH:CAL}$		$0.7 * V_{DD}$			V	
23	Input hysteresis (CAL pin)	$V_{HY:CAL}$		$0.1 * V_{DD}$			V	
24	Input bit time	t_{IB}		6.35		20	μs	7
25	Input half-bit time	t_{IHB}		$0.47 * t_{IB}$		$0.53 * t_{IB}$	μs	8
26	CALIBRATION—mode duration	t_{CAL}		3		17	ms	9
27	STATUS—mode duration	t_{STAT}		10	13.5	16	ms	10
28	WRITE/READ—mode delay	t_{WRD}				1	μs	11
29	WRITE—mode duration	t_{WR}				19	ms	12
30	READ—mode duration	t_{RD}				465	μs	13

OPTICAL CHARACTERISTICS								
#	PARAMETER	SYM	CONDITIONS	MIN	NOM	MAX	UNIT	NOTES
31	Minimum positive going threshold irradiance (DARK \rightarrow LIGHT)	$E_{eT(+)}$	[REF] = 0; [CA] = 'b1; AGC:2; no ambient light		0.16		mW/cm^2	
32	Maximum positive going threshold irradiance (DARK \rightarrow LIGHT)	$E_{eT(+)}$	[REF] = 15; [CA] = 'b1; AGC:0		3.1		mW/cm^2	
33	Hysteresis ratio (positive going threshold irradiance / negative going threshold irradiance)	$E_{eT(+)} / E_{eT(-)}$	Any gain setting; any comparator reference voltage level; [CA] = 'b1; no ambient light	1.1	1.15	1.25	-	
34	Ratio of optical input thresholds at adjacent comparator reference voltage settings	$E_{X(max)}$	Any gain setting; any comparator reference voltage level; [CA] = 'b1; no ambient light		1.075		-	
35	Ambient light immunity	ϵ_V	5780K black-body radiator; amplitude has no frequency components greater than 10 kHz	25			klux	14
36	Optical input threshold sensitivity to V_{DD}	ϵ_T	Any gain setting; any comparator reference voltage level; [CA] = 'b1; no ambient light			4.5%	V^{-1}	
37	Calibration result spread over temperature		Closed system including LED; any comparator reference voltage level; [CA] = 'b1; no ambient light	-25%		25%	-	15

General Note

TT Electronics reserves the right to make changes in product specification without notice or liability. All information is subject to TT Electronics' own data and is considered accurate at time of going to print.

TT Electronics | OPTEK Technology
 1645 Wallace Drive, Carrollton, TX 75006 | Ph: +1 972 323 2200
www.ttelectronics.com | www.optekinc.com

Electrical Specifications (cont.)

Electrical Characteristics (T _A = 25° C unless otherwise noted)							
NON VOLATILE MEMORY CHARACTERISTICS							
#	PARAMETER	SYM	CONDITIONS	MIN	NOM	MAX	UNIT
38	No. of program cycles	P _{CY(amb)}	T _A ≤ 25°C; no ambient light	100K			cy
39	No. of program cycles	P _{CY(hot)}	T _A ≤ 105°C; no ambient light	10K			cy
40	Data retention time	t _{DR}	-40°C ≤ T _A ≤ 105°C; no ambient light	10			yrs

Electrical Characteristics (T _A = 25° C unless otherwise noted)							
LED CHARACTERISTICS							
#	PARAMETER	SYM	CONDITIONS	MIN	NOM	MAX	UNIT
41	Peak wavelength	λ _P	I _F = 20 mA		850		nm
42	Forward voltage	V _F	I _F = 20 mA		1.45	1.55	V
43	Reverse voltage	V _R	I _R = 10 μA	5.0			V
44	Optical power	P _O	I _F = 20 mA	3.2			mW
45	Rise time	T _R	I _F = 20 mA		25		ns
46	Fall time	T _F	I _F = 20 mA		13		ns

Test Notes

- Excludes LED pulsed drive current.
- Time at power-up between VDD settling to within 0.1V of its steady-state level and CAL ↑ at the end of the SETTLE mode interval.
- Time from start of pulse to the point at which the pulsed current reaches within ±1% of the final level and remains in that range for the remainder of the pulse.
- Time from OUT ↓ at the midpoint of the first bit ('b0) to OUT ↑ at the midpoint of the second bit ('b1); should be equal to 10*t_{PER}(T).
- Time from CAL ↑ (indicating completion of internal read command) to OUT ↓ (start of Manchester-encoded LSB of data being read).
- Equal too 2 to 3 LED pulse periods.
- CAL ↓ and ↑ (for 'b0 or 'b1 input bit, respectively) at the time from midpoint of one input bit to CAL ↓ or ↑ at the midpoint of the next input bit; should be equal to 10*t_{PER}(T).
- Time from CAL ↓ or ↑ (for 'b0 or 'b1 input bit, respectively) at the midpoint of one input bit to CAL ↑ or ↓ at the beginning of the next input bit; only applicable if the next input bit is of opposite polarity.
- Time from CAL ↑ at the midpoint of the last input bit of the calibration command sequence to CAL ↓ at the end of a successful calibration; absence of CAL ↓ within this interval means that the calibration failed.
- Time from CAL ↓ at the end of a successful calibration to the subsequent CAL ↑.
- Applicable for read command sequences and for write sequences if the last data input bit is 'b1: time from CAL ↑ at the midpoint of the bit (last data input bit for writes, las command-code bit for reads) to the CAL ↓ following the end of the last data input bit.
- Time from CAL ↓ either after the end of the last data input bit of the write command sequence (if that bit is 'b1) or at the midpoint of that bit (if that bit is 'b0) to the subsequent CAL ↑. Includes any stabilization time required for newly programmed [REF] setting.
- Time from CAL ↓ after the end of the last command-code bit of the read command sequence to the subsequent CAL ↑.
- "Immune" ≡ "optical input threshold moves by ≤5%"
- [[[LED] resulting from calibration @ T) / ([LED] resulting from calibration @ 40°C)] - 1.
- LSL 0.02*VDD for f ≤ 10 kHz, 0.01*VDD for f ≤ 50 kHz, 0.005*VDD for f ≤ 1 mHz.

General Note

TT Electronics reserves the right to make changes in product specification without notice or liability. All information is subject to TT Electronics' own data and is considered accurate at time of going to print.

TT Electronics | OPTEK Technology
 1645 Wallace Drive, Carrollton, TX 75006 | Ph: +1 972 323 2200
www.ttelectronics.com | www.optekinc.com

SMD Reflective Optical Sensor

OPB9000



Typical Characteristics

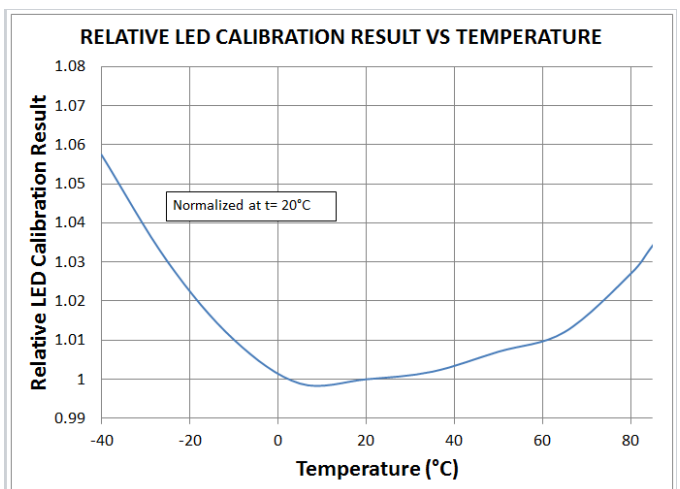
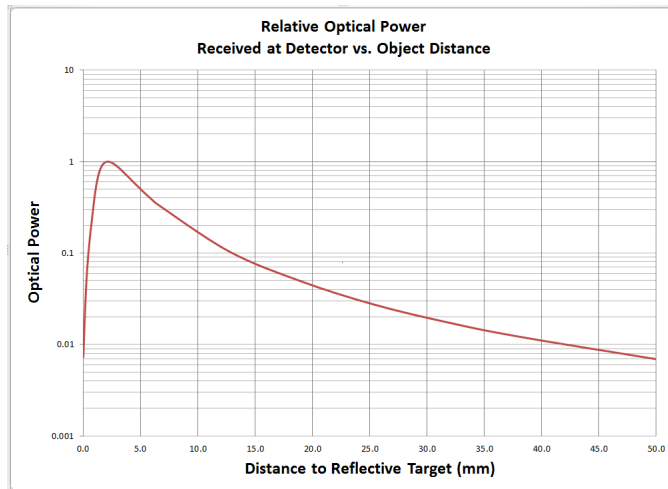
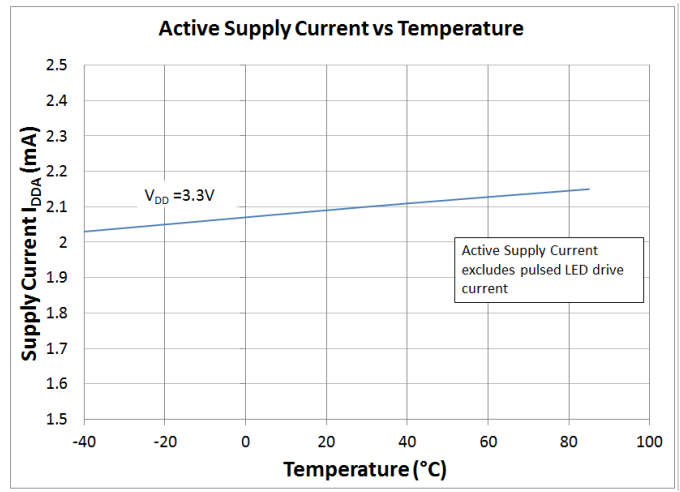
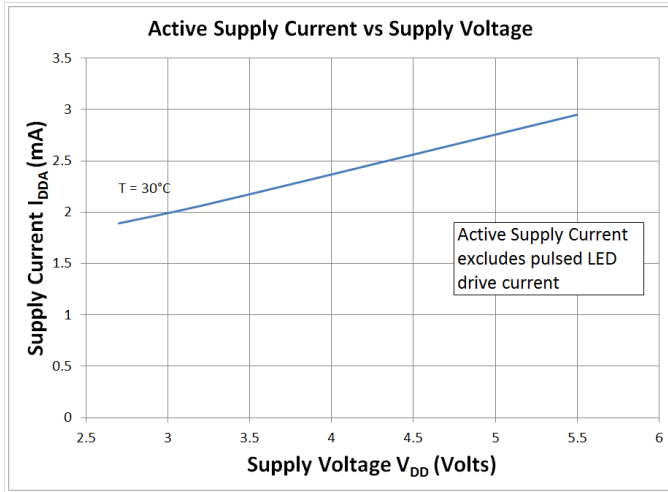

General Note

TT Electronics reserves the right to make changes in product specification without notice or liability. All information is subject to TT Electronics' own data and is considered accurate at time of going to print.

TT Electronics | OPTEK Technology
 1645 Wallace Drive, Carrollton, TX 75006 | Ph: +1 972 323 2200
www.ttelectronics.com | www.optekinc.com

Typical Characteristics

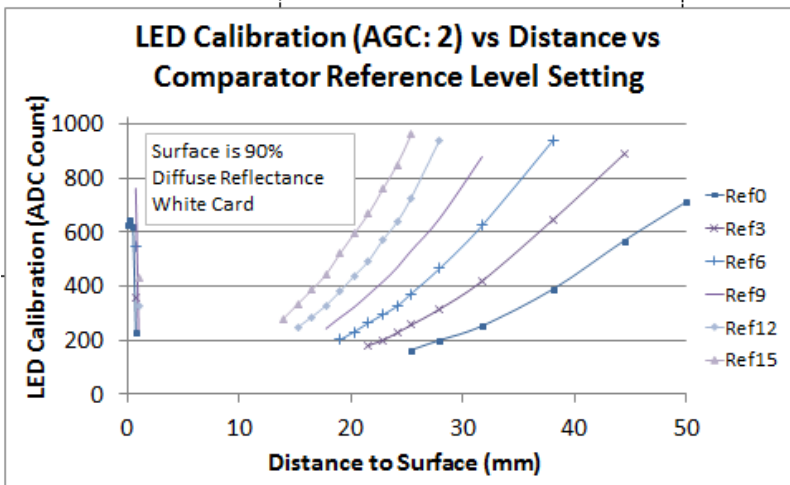
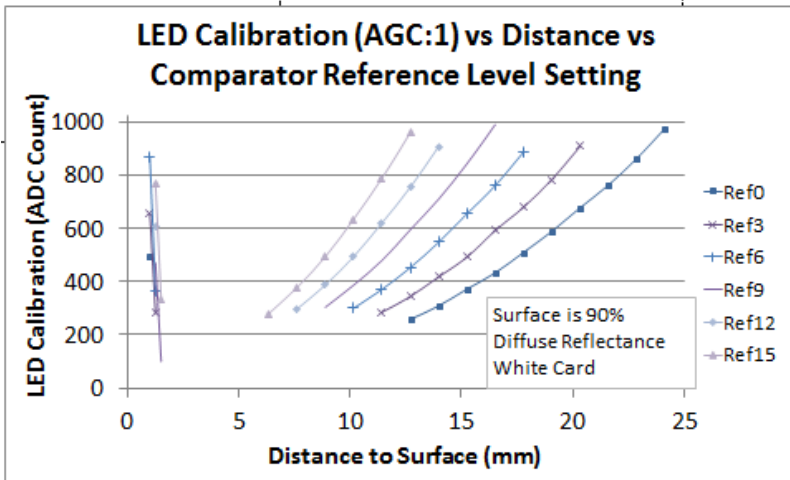
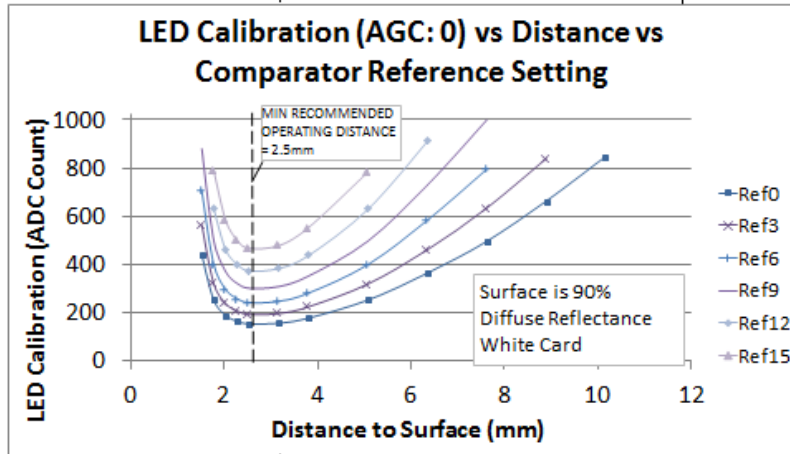

General Note

TT Electronics reserves the right to make changes in product specification without notice or liability. All information is subject to TT Electronics' own data and is considered accurate at time of going to print.

SMD Reflective Optical Sensor

OPB9000



Package Outline, Pinout, and Function Table

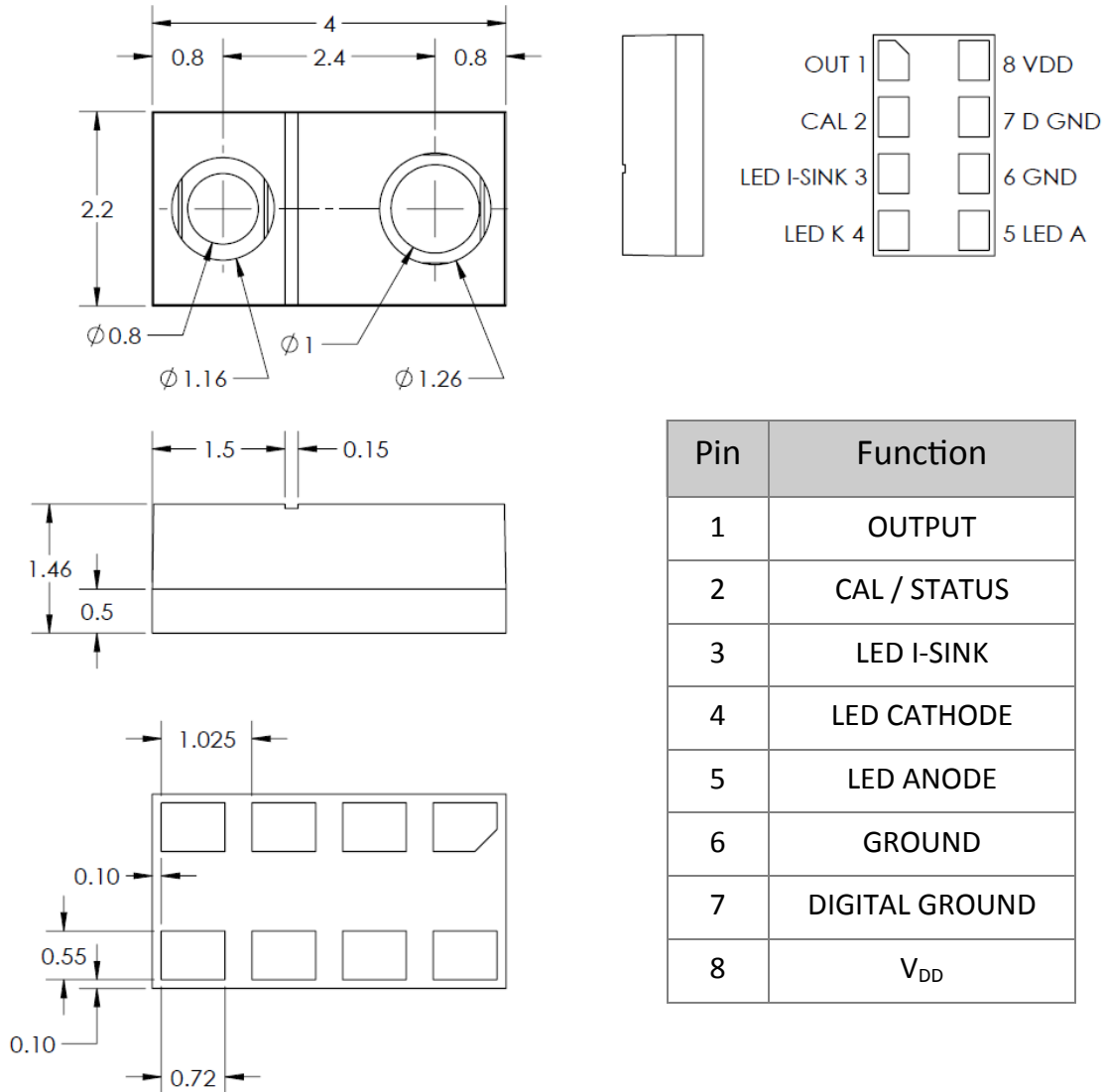

Pin	Function
1	OUTPUT
2	CAL / STATUS
3	LED I-SINK
4	LED CATHODE
5	LED ANODE
6	GROUND
7	DIGITAL GROUND
8	V _{DD}

Notes

1. Dimensions are in mm.
2. Tolerances are ±0.1.
3. Pinout is non-standard.

General Note

TT Electronics reserves the right to make changes in product specification without notice or liability. All information is subject to TT Electronics' own data and is considered accurate at time of going to print.

TT Electronics | OPTEK Technology
 1645 Wallace Drive, Carrollton, TX 75006 | Ph: +1 972 323 2200
www.ttelectronics.com | www.optekinc.com

Recommended Land Pattern (units are mm)

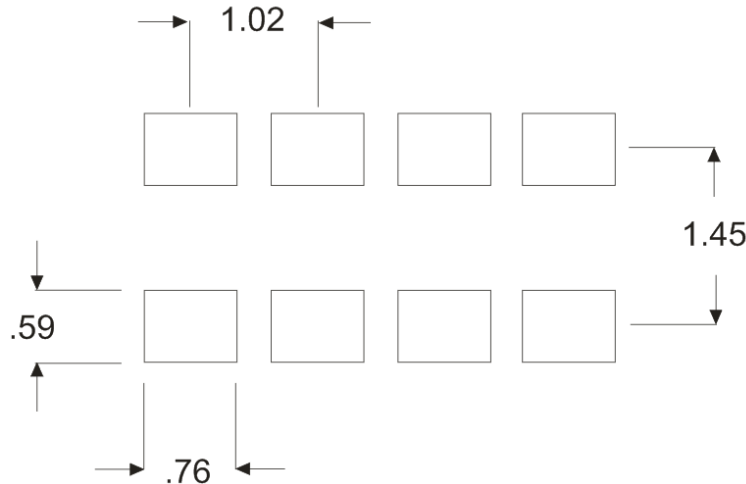

Detailed Description / Application Information

The OPB9000 is a reflective CMOS sensor with calibration features and programmable sensitivity and output type. The monolithic CMOS receiver/LED driver controls all functional modules of the device, including calibrate/status, read/write, and operate.

The device can be calibrated to detect various reflective surfaces at different distances. An on-chip EEPROM is used to store the calibrated LED drive current level, sensitivity level, and output type, allowing the sensor to return to the correct levels and states upon the next power-up cycle. A brief status mode follows every calibration sequence allowing the user to ensure that the calibration was successful. The LED drive current remains in operation mode until a valid command is received (calibrate, read, or write).

Output types and threshold levels can be programmed as part of the calibration process. The default output type is inverter (signal detected, output low), totem pole (push-pull). The output can be programmed to detect either a decreasing signal level or an increasing signal level, but not both at the same time. The filtered amplifier output is integrated for comparison to a 4 bit programmable threshold voltage and the result determines the device output state. If the amplifier output is above or below the threshold voltage for 2 consecutive LED pulses, the output will switch to the proper state. The actual logic level is dependent upon the output type that has been programmed (table 1).

The OPB9000 includes an on-chip photodiode which feeds a bandpass filtered analog front end amplifier to accomplish ambient light immunity as well as signal amplification. An LED driver pulses the LED for 250ns at a pulse rate of 2us (12.5% duty cycle). The OPB9000 switches states when the reflected signal decreases by approximately 50% from the calibrated level. The device includes temperature compensation over its operating temperature range as well as plastic lensing over both LED and detector to narrow the beam spread/viewing angle and maximize detection distance capability.

General Note

TT Electronics reserves the right to make changes in product specification without notice or liability. All information is subject to TT Electronics' own data and is considered accurate at time of going to print.

TT Electronics | OPTEK Technology
1645 Wallace Drive, Carrollton, TX 75006 | Ph: +1 972 323 2200
www.ttelectronics.com | www.optekinc.com

Detailed Description / Application Information

Calibration

Before using the OPB9000, it may be programmed to a specific output type and sensitivity level, and self-calibrated against a specific target at a specific distance from the sensor face.

As supplied, the device is output type inverter (signal detected, output low), push-pull. The sensitivity level is set for detection of a 90% diffuse reflectance white card at a distance of 12mm and a change of state when the reflected signal drops by approximately 50%. This default setting is sufficient for use in many applications. For other applications, the user can re-program and re-calibrate the device for the specific application.

During a calibration process, the pulsed LED drive is ramped from 3 mA to approximately 85 mA (at the above mentioned pulse duration and pulse period) until the reference level is reached for two consecutive pulses. The LED drive current value is then stored in an EEPROM bank. The LED drive ramp is controlled by a 10 bit DAC (1024 steps) at approximately .085 mA per step. The ramping period is 17mS max; a subsequent STATUS mode is active for an additional 13 mS. After a calibration request is sent, and during the ramping period, the CAL/STAT pin will be in a high state. After the ramping period ends with a successful calibration, the pin will transition to a low state for the STATUS mode period (as seen in the screenshot). If the calibration is unsuccessful, then the CAL/STAT pin will remain high for the STATUS mode period. An unsuccessful calibration can occur if there is no reflective surface present, or insufficient light received during the calibration process.

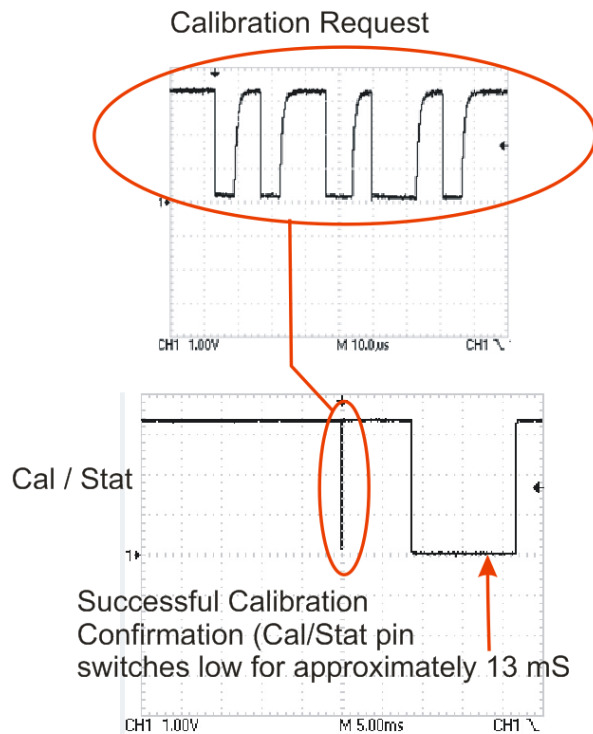

General Note

TT Electronics reserves the right to make changes in product specification without notice or liability. All information is subject to TT Electronics' own data and is considered accurate at time of going to print.

Detailed Description / Application Information

During the calibration process, the internal state machine will set the amplifier circuit gain to the lowest of three gain setting options. The two bit AGC (gain control) setting will be written to Bank 1 of EEPROM along with the 10 LED drive level bits and the one CA (calibration successful) bit.

The procedure for calibrating the OPB9000 usually includes sending three commands to the device on the calibrate/status pin. Those commands are as follows:

- Command 1 — send write command to set output type (OP and DS bits, table 1) and comparator reference level bits (table 2)
- Command 2 — send command to calibrate LED drive
- Command 3 — send write command to change comparator to new desired reference level (this indirectly sets detection sensitivity; see next section)

Programmable Sensitivity Levels

The sensitivity level is not programmed directly. Instead it is determined by the difference in the reference level settings between command 1 and command 3 in the previous section. See table 2 for available reference level settings. Below are a few examples of sensitivity level settings.

- Example 1: A device is programmed to a reference level setting of 2 during the writing of command 1 to the device. This establishes a relatively low trip threshold of approximately 281 mV during the LED calibration step (Command 2), which would normally be needed in cases where the reflected light levels are low, e.g. the target surface has low reflectance and/or the target is far from the device. In cases where the target is more reflective or closer to the sensor, a higher reference level could be selected if desired. In general, the higher the reference level used for the Command 1 write, the higher the LED drive required to calibrate the device. During the writing of command 3 to the device, the reference level setting is changed from 2 to 0. This establishes the comparator trip level at approximately 245 mV. This level is 87% (245/281) of the level used to calibrate the LED drive. Therefore, an approximate 13% reduction in light level will now cause the output state to change.
- Example 2: A device is again programmed to a reference level setting of 2 during the writing of command 1 to the device. During the writing of command 3 to the device, the reference level setting is changed to 6, causing an immediate output state change to its pre-calibrated level. Ref level 6 establishes the comparator trip level at approximately 368 mV. This level is 131% (368/281) of the level used to calibrate the LED drive. Therefore, an approximate 31% increase in light level will be required to cause the output state to change.
- Example 3: A device is programmed to a reference level setting of 14 during the writing of command 1 to the device. During the writing of command 3 to the device, the reference level setting is changed to 3. This level is 47% (300/632) of the level used to calibrate the LED drive. Therefore, an approximate 53% decrease in light level will be required to cause the output state to change.

EEPROM STRUCTURE

BANK 1 (13 bits)

LED drive counts (10 bits)	Gain control (2 bits)	Calibration successful (1 bit)
LED REF <12:3>	GC <2:1>	CA <0>

BANK 2 (6 bits)

Output type (1 bit)	Drain select (1 bit)	Comparator REF (4 bits)
OP <5>	DS <4>	REF <0:3>

BANK 3 (9 bits RESERVED)

7 RESERVED Bits

General Note

TT Electronics reserves the right to make changes in product specification without notice or liability. All information is subject to TT Electronics' own data and is considered accurate at time of going to print.

TT Electronics | OPTEK Technology
1645 Wallace Drive, Carrollton, TX 75006 | Ph: +1 972 323 2200
www.ttelectronics.com | www.optekinc.com

Detailed Description / Application Information

Communication Standard

The Manchester Code follows the standard IEEE 802.3:

- “0” is expressed as a midpoint high-to-low transition, “1” is as low-to-high transition
- Encoded output = data XOR clock

The waveform chart below shows the Manchester encoded output for each possible two bit sequence.

Commands

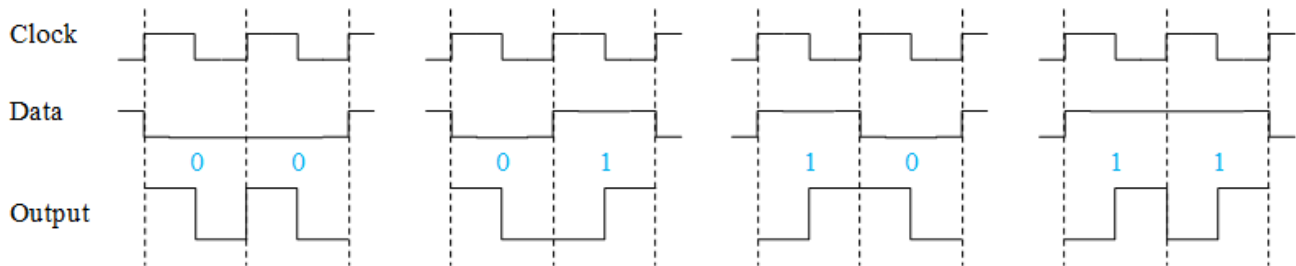

All commands sent to the OPB9000 are sent via the CAL/STAT pin. Each command must first begin with the syncing nibble (1100). The first two bits “11” allow the decoder to detect the data clock. The second two bits are a check for detection of the “00” data. The third two bits determine the command being sent. The available commands are:

- 1100-00 Reserved (do nothing)
- 1100-01 Read request
- 1100-10-bbbbb Write Bank 2 bits
- 1100-11 Calibrate request

For a read or calibration request, there will be 6 bits: “1100-01” or “1100-11” respectively:

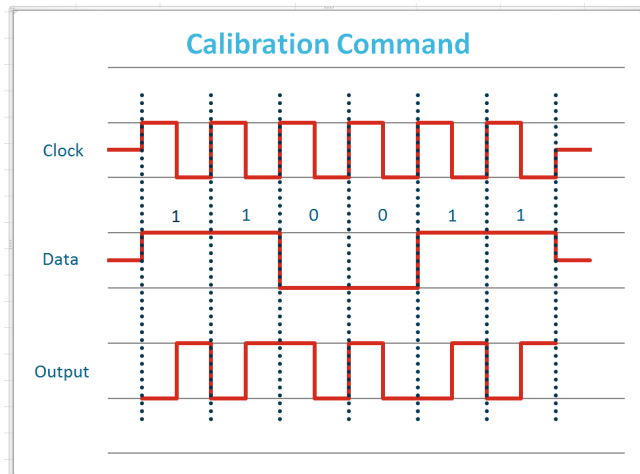

General Note

TT Electronics reserves the right to make changes in product specification without notice or liability. All information is subject to TT Electronics' own data and is considered accurate at time of going to print.

Detailed Description / Application Information

Commands (cont.)

For a Write Bank 2 command, there will be a total of 12 bits: “1100-10-bbbbb”, where the last 6 bits are data to be written to EEPROM. These 6 data bits are defined in table 1 (OP,DS bits) and table 2 (comparator REF bits 0-3). The sequence of transmission of these bank 2 bits must be from least significant to most significant bit—i.e. bit 0 to bit 5 (after syncing nibble and two clock detection bits). The data rate for the write command is 100 kb/s [+100 kb/s, -50 kb/s].

Read Request Data Bit Sequence and Rate

The read request will serially output, from the Vout pin, the EEPROM bank values and also include an error flag. A total of 37 bits will be transmitted including a zero as the first bit and an error flag bit as the 2nd bit.

	BANK 3 (RESERVED)											BANK 1 (LED COUNT, AGC, & CA BITS)																									
	Start Bit	Error Flag	Reserved	Reserved	Reserved	Reserved	Reserved	Reserved	Reserved	Reserved	Reserved	Reserved	CA bit	AGC (LSB)	AGC (MSB)	LED (LSB)	LED	LED	LED	LED	LED	LED	LED	LED	LED	LED	LED (MSB)										
Bit Value	0	X	X	X	X	X	X	X	X	X	X	X	X	X	X	X	X	X	X	X	X	X	X	X	X	X	X	X	X								
Bit #	1	2	3	4	5	6	7	8	9	10	11	12	13	14	15	16	17	18	19	20	21	22	23	24	25	26	27	28	29	30	31	32	33	34	35	36	37
Example	0	0	0	1	1	0	0	1	0	1	0	1	1	0	1	1	0	1	1	1	0	1	1	1	1	1	1	1	1	1	1	1	1	1	1	1	

	BANK 2 (OP, DS, & REF BITS)						RESERVED										
	REF (LSB)	REF	REF	REF (MSB)	DS bit	OP bit	Reserved	Reserved	Reserved	Reserved	Reserved	Reserved	Reserved	Reserved	Reserved	Reserved	
Bit Value	X	X	X	X	X	X	0	0	0	0	0	0	0	0	0	0	
Bit #	25	26	27	28	29	30	31	32	33	34	35	36	37				
Example	0	0	0	1	0	0	0	0	0	0	0	0	0				

- NOTES:
1. "X" INDICATES BIT VALUE CAN BE ONE OR ZERO
 2. "0" INDICATES BIT VALUE WILL ALWAYS BE ZERO
 3. IN EXAMPLE SHOWN, LED COUNT=59, AGC=1, CA=1, REF=8, DS=0, OP=0.
 4. THE WAVEFORM GENERATED AT THE OUTPUT PIN, IN RESPONSE TO A READ REQUEST TO THE CAL/STAT PIN, IS SHOWN BELOW.

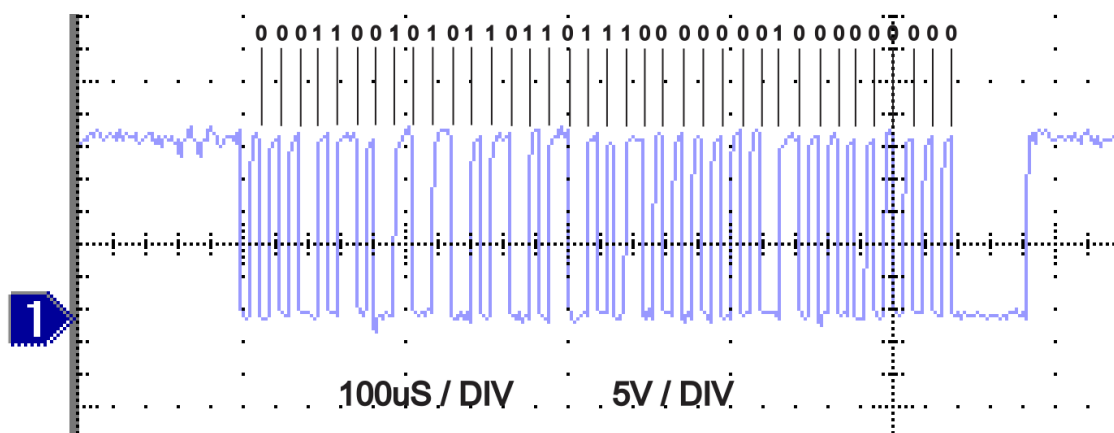

General Note
TT Electronics reserves the right to make changes in product specification without notice or liability. All information is subject to TT Electronics' own data and is considered accurate at time of going to print.

Detailed Description / Application Information

Commands (cont.)

Normally the end user will only have interest in the error flag and bank 2 bits. In some cases the bank 1 bits values may also prove useful.

This data is Manchester encoded and transmitted at 100 kb/s \pm 5 kb/s. The data duty cycle is 50% \pm 10%.

Error Flag

After data is written to a bank of EEPROM, the state machine will compare the content (read out from the same bank) to the data written in. Normally the read data is the same as the write data, but if there is a difference, the Error Flag will be set to "1".

Communication Pins

The CAL/STATUS pin is used to write data to the OPB9000 and the initiate a calibration sequence.

This pin is also used during the STATUS mode to output the status of an attempted calibration. See Calibration section of this data sheet for more information.

The Output pin is used to read the value of all EEPROM bits. See previous section (Commands) for more information.

General Note

TT Electronics reserves the right to make changes in product specification without notice or liability. All information is subject to TT Electronics' own data and is considered accurate at time of going to print.

Detailed Description / Application Information

Table 1—Programmable Output Types

EEPROM BANK2 BIT 5	EEPROM BANK2 BIT 4	DRIVER TYPE	POLARITY
OP (OUTPUT POLARITY)	DS (DRAIN SELECT)		
0	0	Open drain	Buffered
1	0	Open drain	Inverted
0	1	Push-pull	Buffered
1	1	Push-pull	Inverted

Table 2—Programmable Comparator Reference Levels

REF LEVEL (DECIMAL)	COMP_REF_SEL <3:0>				COMPARISON THRESHOLD DIFFERENTIAL (MV)
	EEPROM BANK2 BIT 3	EEPROM BANK2 BIT 2	EEPROM BANK2 BIT 1	EEPROM BANK2 BIT 0	
0	0	0	0	0	245
1	0	0	0	1	262
2	0	0	1	0	281
3	0	0	1	1	300
4	0	1	0	0	321
5	0	1	0	1	344
6	0	1	1	0	368
7	0	1	1	1	393
8	1	0	0	0	421
9	1	0	0	1	450
10	1	0	1	0	482
11	1	0	1	1	516
12	1	1	0	0	552
13	1	1	0	1	590
14	1	1	1	0	632
15	1	1	1	1	676

Detailed Description / Application Information - Operational Flow Diagram

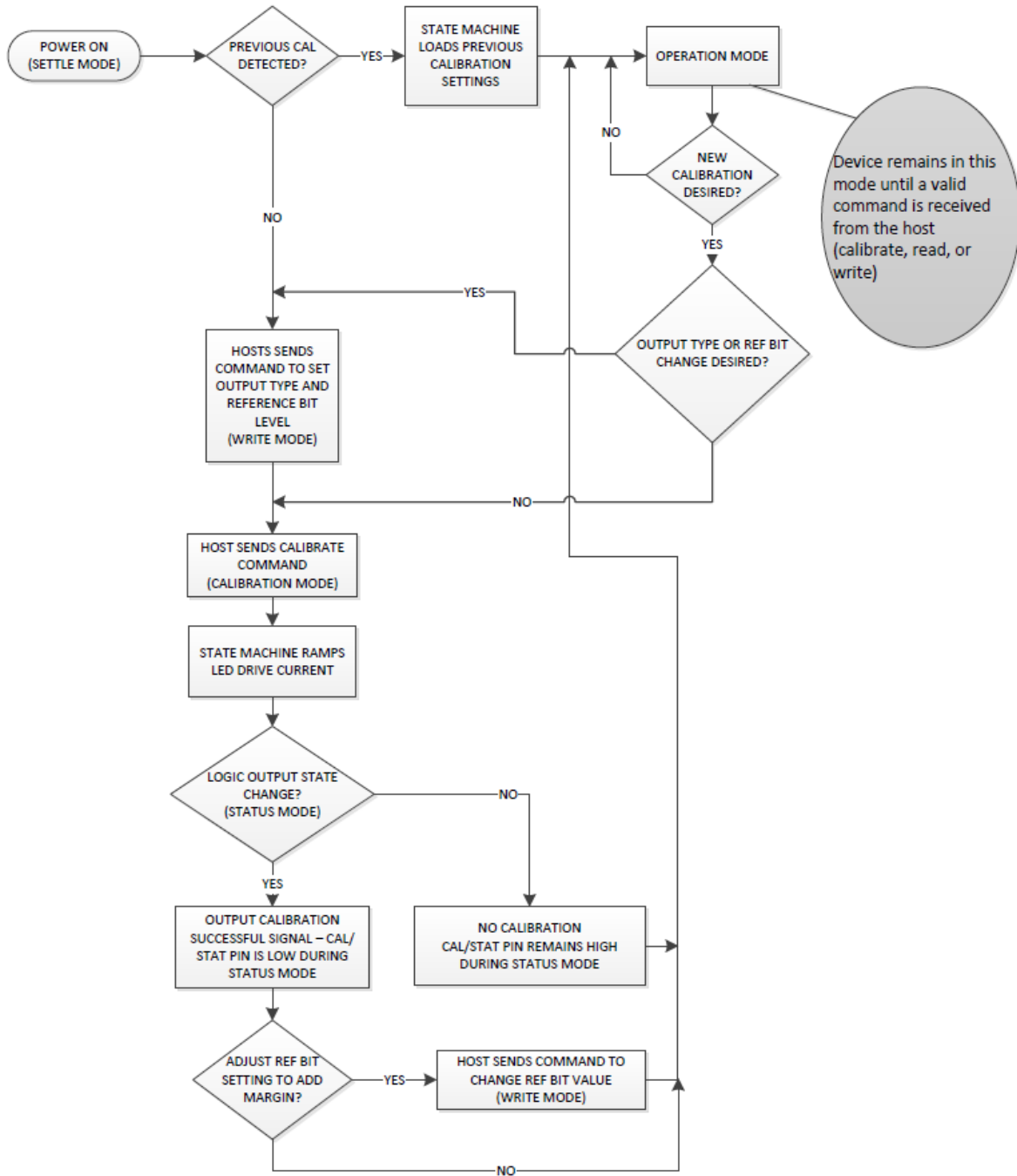

General Note
TT Electronics reserves the right to make changes in product specification without notice or liability. All information is subject to TT Electronics' own data and is considered accurate at time of going to print.

TT Electronics | OPTEK Technology
1645 Wallace Drive, Carrollton, TX 75006 | Ph: +1 972 323 2200
www.ttelectronics.com | www.optekinc.com

SMD Reflective Optical Sensor

OPB9000



Issue	Change Description	Approval	Date
1	Initial draft	Ramon Martinez	7/30/2013
2	Update package dimensions	Ramon Martinez	12/12/2013
3	Update SDD size and package dimensions	Ramon Martinez	1/9/2014
4	Rewrite data sheet to match SDR 1.8 design; change to latest format	Don Cook	6/9/2015
5	Added verbiage to 1st page description and application information. Changed application circuit. Changed active supply current, optical response time, hysteresis ratio, typical optical input thresholds, ratio of output threshold limits, and calibration result over temp test limits. Added figure 2 "read request data bit".	Don Cook	7/6/2015
6	Update specification for wake-up time, LED pulsed drive current, pull-up resistance (OUT) pin, pull-up resistance (CAL) pin, input bit time, STATUS-mode duration, WRITE-mode duration, READ-mode duration, $E_{X(MAX)}$, optical input threshold sensitivity to V_{DD} , ESD immunity. Added LED calibration vs. distance charts.	Shivesh Langhanoja Don Cook	9/21/2015
7	Replaced sheet 16 with new sheet 16 & 17 (figure 2). Replaced recommended application circuit page 2.	Don Cook	10/26/2015
8	Change 10mm to 6mm on page 1. Added note to page 2: "Make GND to D_GND connection at device." Clarified REF and AGC info in tests 31 & 32 on page 5. Changed "Low's" and "High's" in table 1 page 14 to "0's" and "1's". Added note 3 to page 9.	Don Cook	5/20/2016
9	Converted to latest TT Data Sheet format. Added I_{DD} with LED test. Added product photo to sheet 1; changed "device" to "programmable"; Reordered features on sheet 1; Extended relative optical power chart on page 7 to 50mm. Added minimum recommended distance to charts on page 8 and changed x axis units from inches to mm. Added "causing an immediate output state change to its pre-calibrated level" to sheet 12, example 2.. Corrected page 17 tape and reel information.	Don Cook	6/21/2016
10	Changed 95 to 85 on test 6, page 4. Changed 75mA to 85mA, .075 mA to .085mA, and 10mm to 6mm on page 11. Inserted new page 17 "Operational Flow Diagram". Changed four gain settings to three gain settings on sheet 12.	Don Cook	7/19/2016
11	Changed note 17 to note 16 on sheet 4; Changed 6mm to 12mm on page 1 and page 11.		
A	Initial Release	Don Cook	9/2/2016

General Note

TT Electronics reserves the right to make changes in product specification without notice or liability. All information is subject to TT Electronics' own data and is considered accurate at time of going to print.

TT Electronics | OPTEK Technology
1645 Wallace Drive, Carrollton, TX 75006 | Ph: +1 972 323 2200
www.ttelectronics.com | www.optekinc.com