

# 通用规格

## 电气容量 (电阻性负载)

大功率 (编号W):	6A在125V AC和3A在250V AC 4A在30V DC对于On-None-On和On-None-Off; 3A在30V DC对于所有其他电路
微小功率 (编号G):	最大0.4VA在最高28V AC/DC (适用范围0.1mA~0.1A在20mV~28V)
小功率/大功率 (编号A):	与W和G额定参数相结合

注: 请参阅附录中关于双额定值和工作范围的更多说明

## 其他额定参数

触点电阻:	银触点最大10毫欧; 金触点最大20毫欧
绝缘电阻:	1,000兆欧以上在500V DC
绝缘强度:	触点间最低1,000V AC至少1分钟; 触点与外壳之间最低1,500V AC至少1分钟
机械寿命:	100,000次操作以上; 对于扁平、钥匙锁、以及防溅入保护开关为50,000次操作以上
电气寿命:	银触点25,000次操作以上; 金触点50,000次操作以上; 银触点50,000次操作以上在3A和125V AC
标称操作力:	单极为3.92N; 双极为4.41N; 3极为6.86N; 4极为7.85N
摆动角度:	25°

## 材质和涂覆

摇杆:	黄铜镀铬	框架:	不锈钢
衬套:	黄铜镀镍	支撑支架:	钢镀锡
外壳:	苯二酸二烯丙酯树脂 (UL94V-0)		
活动接触器:	磷青铜镀银或金		
活动触点:	银合金 (编号W); 铜镀金 (编号G); 银合金镀金 (编号A)		
固定触点:	银镀银 (编号W); 铜或黄铜镀金 (编号G); 或银镀金 (编号A)		
端子:	铜或黄铜镀银; 或铜或黄铜镀金		

## 环境数据

工作温度范围:	-30°C到+85°C (22°F到+185°F)
湿度:	96小时内40°C (104°F)时, 湿度90~95%
振动:	用1.5mm峰-峰振幅遍历10~55Hz频率范围、并在1分钟内返回; 3个直角方向2小时
冲击:	50G (490m/s <sup>2</sup> ) 加速度 (在6个直角方向上测试, 每个方向5次冲击)
密封:	面板密封衬套选项B3和D3符合IEC60529标准的IP67。

## 安装

安装扭矩:	大型衬套为3.0Nm (26.55 lb•in) 双螺母; 所有其他衬套为1.5Nm (13 lb•in)双螺母和0.7Nm (6 lb•in)单螺母
-------	--

## 处理

焊接:	对于金的波峰焊 (电脑版): 请参阅附录中的概略图A。 对于金的手工焊接: 请参阅附录中的概略图A。 对于银的波峰焊 (电脑版): 请参阅附录中的概略图B。 对于银的手工焊接: 请参阅附录中的概略图B。 注: 焊接时操纵杆必须置于OFF (中央) 位置。
清洗:	这些装置未经密封处理。用酒精溶剂就地手工清洗。

## 标准和认证



易燃性标准:	UL94V-0外壳
UL认证:	所有型号的认证条件均为6A在125V AC、或3A在250V AC、或最大0.4VA在最大28V DC; UL文件号WOYR2.E44145; 在零件编号最后添加"/U"来订购有UL标记的开关。



C-UL认证:	所有型号的认证条件均为6A在125V AC、或3A在250V AC、或最大0.4VA在最大28V DC; C-UL文件号WOYR8.E44145; 在零件编号最后添加"/C-UL"来订购有C-UL标记的开关。
---------	---



CSA认证:	所有型号的认证条件均为6A在125V AC、或3A在250V AC、或最大0.4VA在最高28V DC; CSA文件号023535-0-000; 在零件编号最后添加"/C"来订购有CSA标记的开关。
--------	--

# 主要特点

防旋转设计，非圆柱形搬动杆规格，与摇杆和衬套紧密相配；摇杆底部有两个扁平的侧面，恰好适配于衬套内部的辅助孔。

抗干扰设计可防止施加在操作部上过度的向下的力导致触点损坏。

高扭矩衬套结构可防止安装时摇杆转动或从框架上脱离。

高性能绝缘层增加了多极开关中电路之间的绝缘能力，并为触点提供了额外保护。

注塑苯二酸二烯丙酯树脂外壳符合UL易燃性标准的94V-0规定。

环氧树脂密封端子可防止焊接溶剂或其他污染物侵入。

卓越的外部绝缘层更增加绝缘电阻和绝缘强度。

联锁的操作模块、搬动杆、以及内部导向装置，可防止搬动杆偏斜运动引起的开关失效。

在基座与端子之上框架与外壳紧配在一起，这样可达到1,500V绝缘强度。

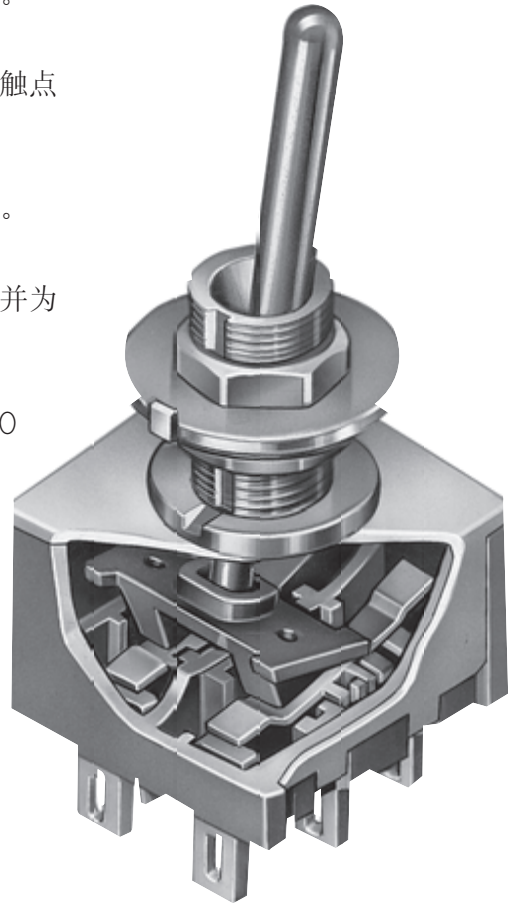

实际尺寸

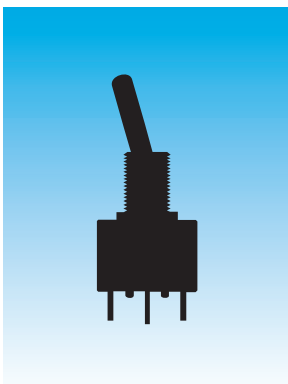

	衬套安装	A36页
	配有支架的 PC端子安装	A46页
	角PC端子安装	A52页

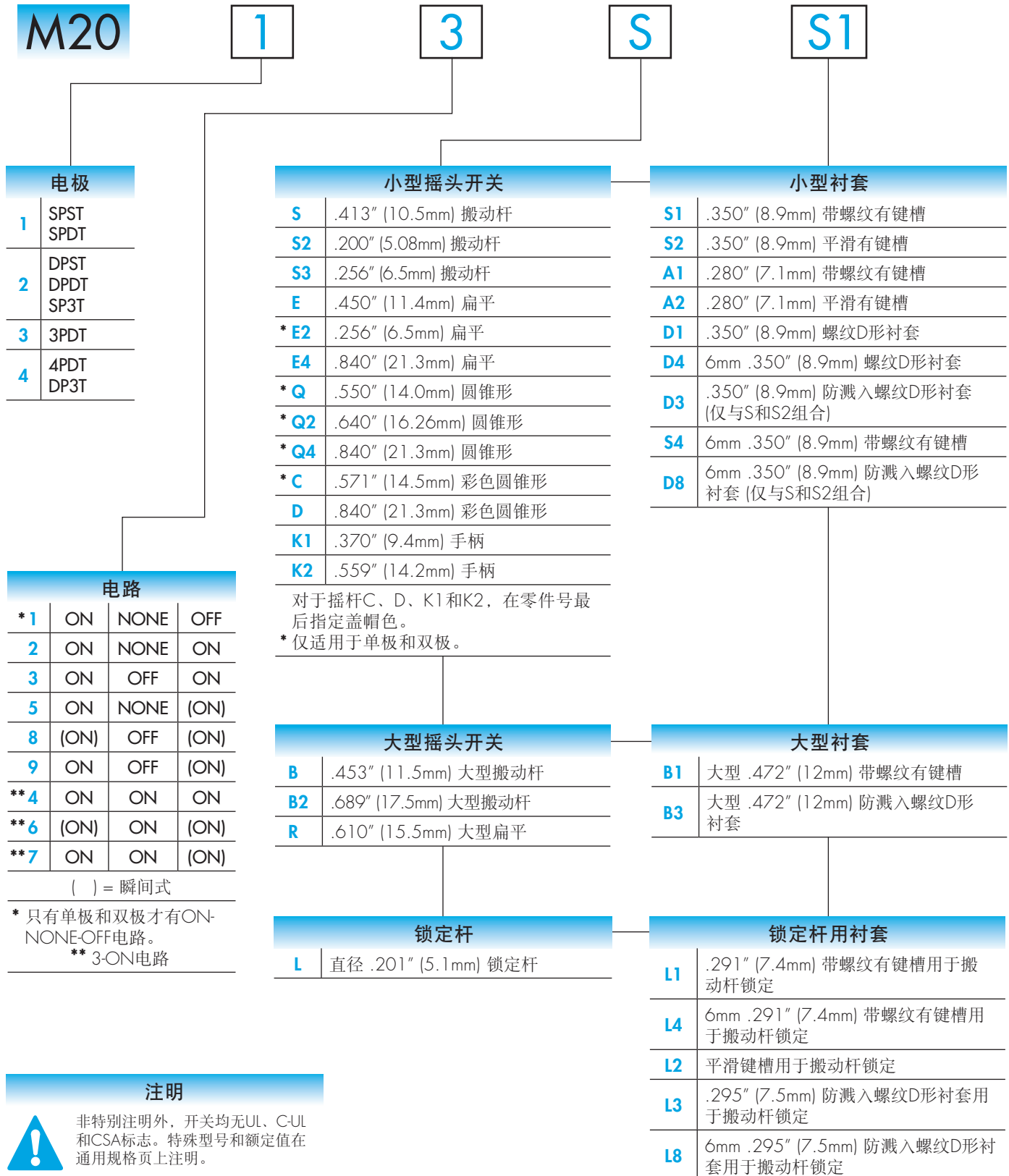

### 注明

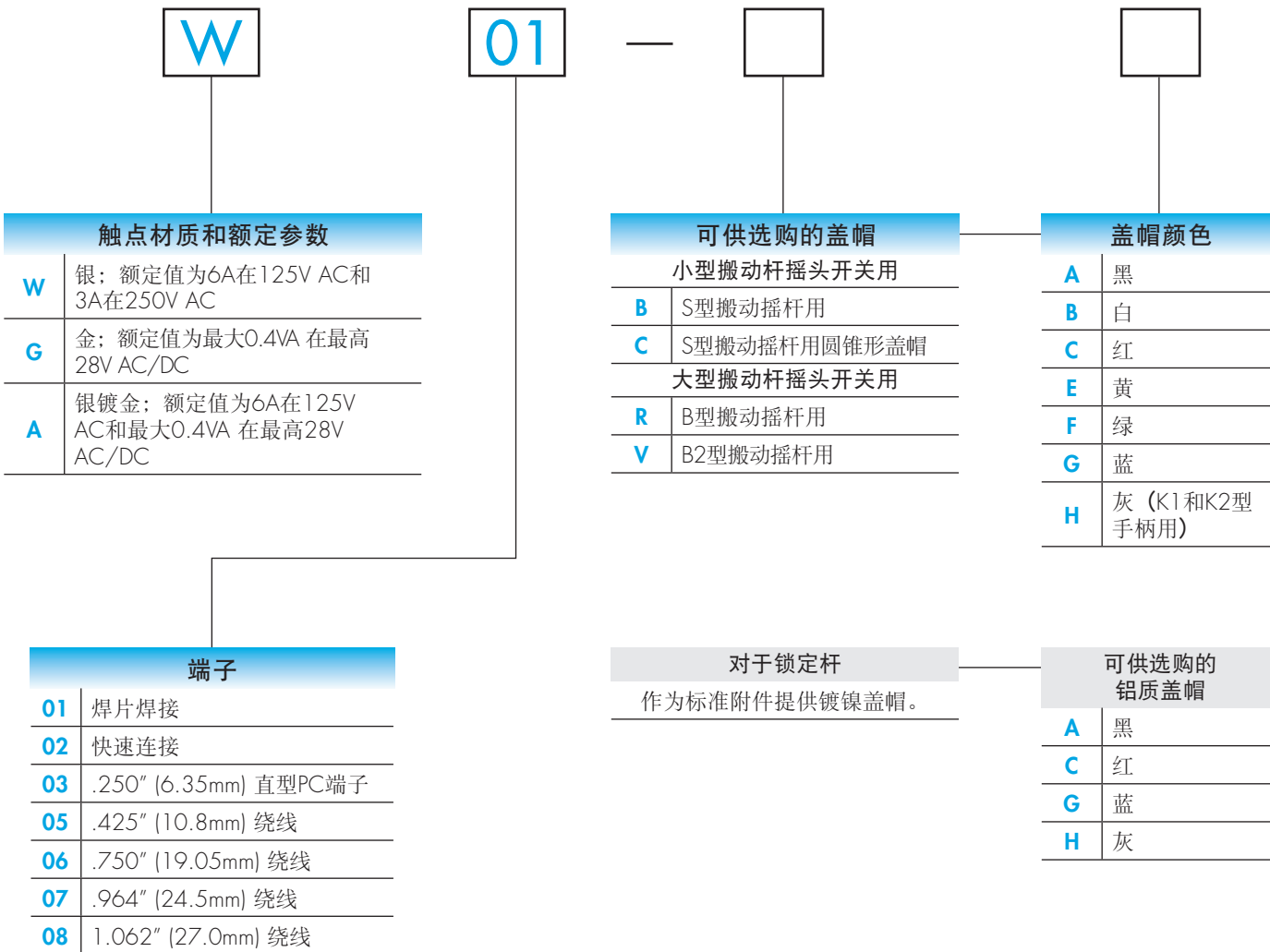
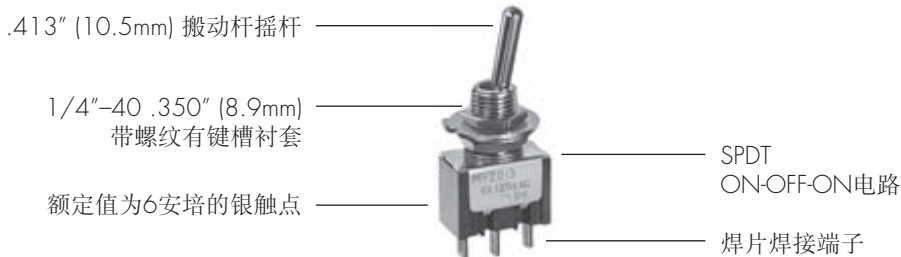

非特别注明外，开关均无UL、C-UL和CSA标志。特殊型号和额定值在通用规格页上注明。

**订购举例**

**典型订购举例**
**M2013SS1W01**

### 电极和电路

电极	型号	摇杆位置 ( ) = 瞬间式			连接的端子			投掷及其示意图
		下 键槽	中	上	下 键槽	中	上	
SP	M2011	ON	NONE	OFF	2-3	OPEN	OPEN	SPST 
SP	M2012 M2013 M2015 M2018 M2019	ON ON ON (ON) ON	NONE OFF NONE OFF OFF	ON ON (ON) (ON) (ON)	2-3	OPEN	2-1	SPDT 
DP	M2021	ON	NONE	OFF	2-3 5-6	OPEN	OPEN	DPST 
DP	M2022 M2023 M2025 M2028 M2029	ON ON ON (ON) ON	NONE OFF NONE OFF OFF	ON ON (ON) (ON) (ON)	2-3 5-6	OPEN	2-1 5-4	DPDT 
3P	M2032 M2033 M2035 M2038 M2039	ON ON ON (ON) ON	NONE OFF NONE OFF OFF	ON ON (ON) (ON) (ON)	2-3 5-6 8-9	OPEN	2-1 5-4 8-7	3PDT 
4P	M2042 M2043 M2045 M2048 M2049	ON ON ON (ON) ON	NONE OFF NONE OFF OFF	ON ON (ON) (ON) (ON)	2-3 5-6 8-9 11-12	OPEN	2-1 5-4 8-7 11-10	4PDT 

### 3掷(3-On)

电极	型号	下	中	上	连接的端子及其示意图		
SP	M2024 M2026 M2027	ON (ON) ON	ON ON ON	ON (ON) (ON)			
DP	M2044 M2046 M2047	ON (ON) ON	ON ON ON	ON (ON) (ON)			

SP3T型使用双极基座。

在现场安装时必须进行外部连接。

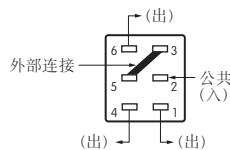

DP3T型使用4极基座。

在现场安装时必须进行外部连接。

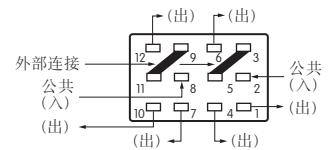

### 小型摇头开关

**重要:**

根据所选衬套选定摇杆长度。  
所有插图均以.350"长度衬套为例。  
当使用.280"长度衬套时，摇杆长度增加.070"。

**S** .413" (10.5mm)  
搬动杆

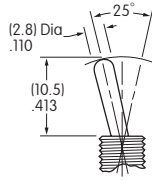

**S2** .200" (5.08mm)  
搬动杆

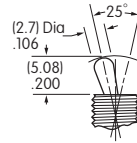

**S3** .256" (6.5mm)  
搬动杆

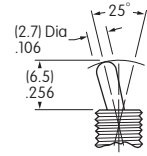

标准材质和涂覆：黄铜镀铬抛光  
如欲采用其他可选涂覆，请与厂家联系。

**E** .450" (11.4mm)  
扁平

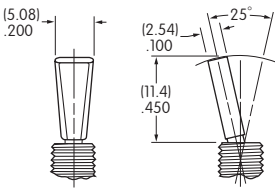

**E2** .256" (6.5mm)  
扁平

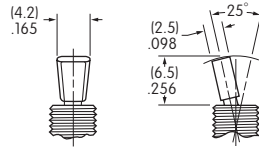

**E4** .840" (21.3mm)  
扁平

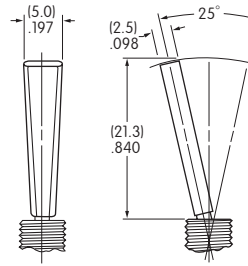

仅适用于单板和双板

**C** .571" (14.5mm)  
彩色圆锥形  
随同AT445型盖帽一起提供  
材质：聚碳酸酯

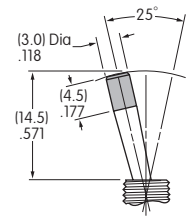

仅适用于单板和双板

**Q** .550" (14.0mm)  
圆锥形

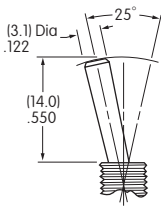

**Q2** .640" (16.26mm)  
圆锥形

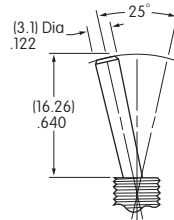

仅适用于单板和双板

**Q4** .840" (21.3mm)  
圆锥形

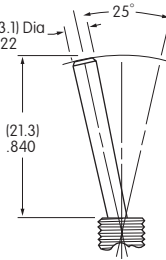

仅适用于单板和双板

**D** .840" (21.3mm)  
彩色盖帽圆锥形  
随同AT460型盖帽一起提供  
材质：聚乙烯

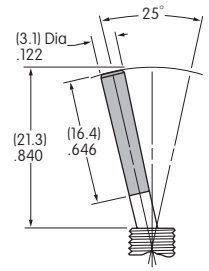

仅适用于单板和双板

**K1** .370" (9.4mm)手柄  
随同AT467型盖帽一起提供  
材质：聚酰胺

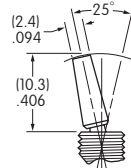
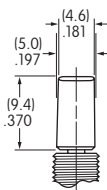

**K2** .559" (14.2mm)手柄  
随同AT468型盖帽一起提供  
材质：聚酰胺

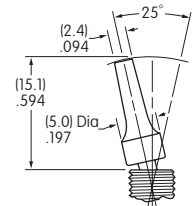
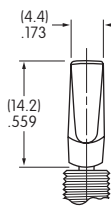

可供选择的盖帽颜色:

**A** 黑

**B** 白

**C** 红

**E** 黄

**F** 绿

**G** 蓝

**H** 灰

(仅适用于K1和K2型)

## 小型衬套

**S1** 1/4-40 .350" (8.9mm)  
带螺纹有键槽

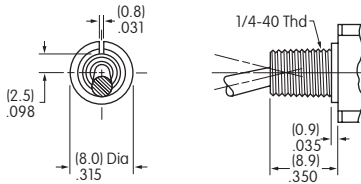

**S2** .350" (8.9mm)  
平滑有键槽

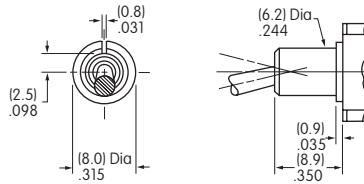

**S4** 6mm/.350" (8.9mm)  
带螺纹有键槽

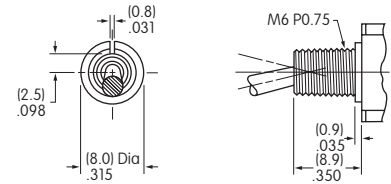

面板厚度  
带标准配件最大: .102" (2.6mm)

面板厚度  
带标准配件最大: .102" (2.6mm)

**A1** .280" (7.1mm)  
带螺纹有键槽

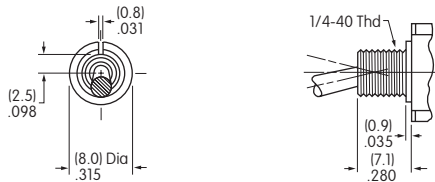

当使用该衬套时, 摇杆长度增加.070"。  
面板厚度  
带标准配件最大: .031" (0.8mm)

**A2** .280" (7.1mm)  
平滑有键槽

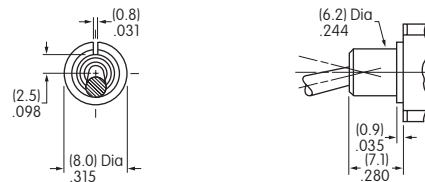

当使用该衬套时, 摇杆长度增加.070"。

**D1** .350" (8.9mm)  
螺纹D形衬套

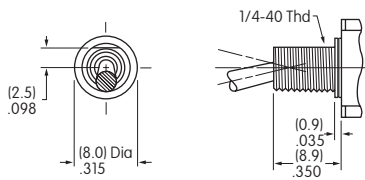

面板厚度  
带标准配件最大: .102" (2.6mm)

**D4** 6mm/.350" (8.9mm)  
螺纹D形衬套

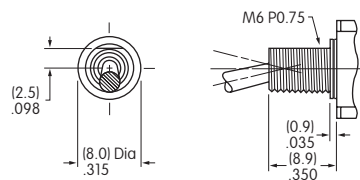

面板厚度  
带标准配件最大: .102" (2.6mm)

**D3** 1/4-40 .350" (8.9mm)  
防溅入螺纹D形衬套

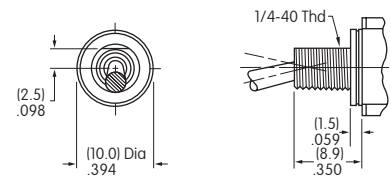

D3仅与S和S2型摇杆组合。  
面板厚度  
带标准配件最大: .193" (4.9mm)

**D8** 6mm/.350" (8.9mm)  
防溅入螺纹D形衬套

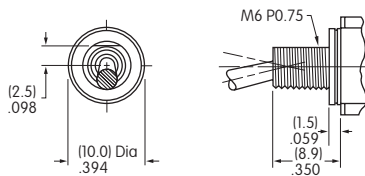

用于小型衬套的标准配件		衬套编号	S1/S4	A1	D1/D4	D3/D8	L1/L4	L3/L8
配件及其数量	六角螺母		2	2	2	1	2	1
	锁环		1	1	0	0	1	0
	锁紧垫圈		1	1	1	0	1	0
	○型圈		0	0	0	1	0	1

用于S1、S2、A1、A2、或S4型有键槽衬套和L1或L4型衬套

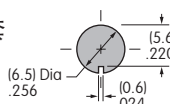

用于S1、A1、或S4型有锁环衬套和L1或L4型衬套

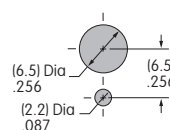

用于D1、D4、D3、或D8型有D型扁平的衬套和L3或L8型衬套

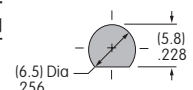

## 大型摇头开关

摇杆和衬套的组合：这些摇杆与12mm衬套B1型和B3型组合。

**B** .453" (11.5mm)  
大型搬动杆

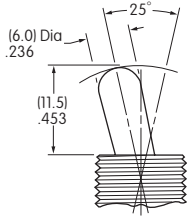

**B2** .689" (17.5mm)  
大型搬动杆

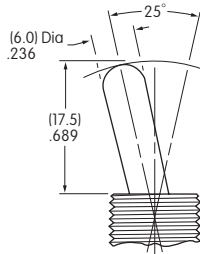

**R** .610" (15.5mm)  
大型扁平

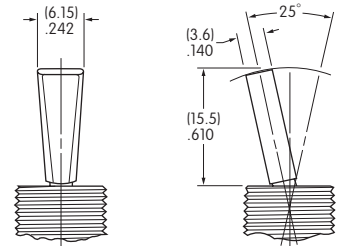

标准材质和涂覆：黄铜镀铬抛光

可选的涂覆：关于压光铬或黑色，请与厂家联系。

## 大型衬套

**B1** 大型 .472" (12.0mm)  
带螺纹有键槽

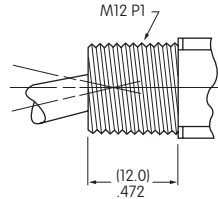
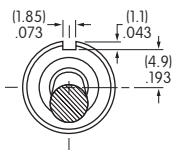

面板厚度  
带标准配件最大：.216" (5.5mm)

**B3** 大型 .472" (12.0mm)  
防溅入螺纹D形衬套

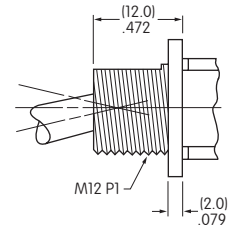
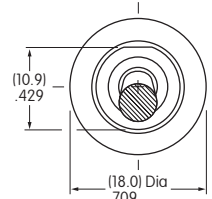

面板厚度  
带标准配件最大：.256" (6.5mm)

**B1型的标准配件：**

1个正面六角螺母AT503M，1个锁环AT506M，  
1个锁紧垫圈AT508，以及1个备用六角螺母AT527M

**B3型的标准配件：**

1个正面六角螺母AT503M  
和1个O型圈AT401P

## 面板裁切

用于B1型有键槽衬套

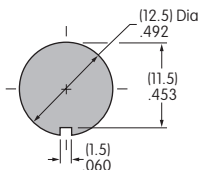

用于B1型有锁环衬套

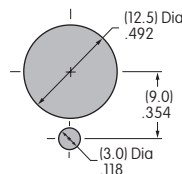

用于B3型的D型扁平衬套

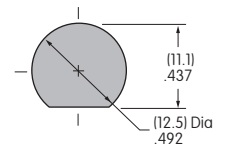



## 锁定杆和衬套

**LL1** .291" (7.4mm)  
带螺纹有键槽

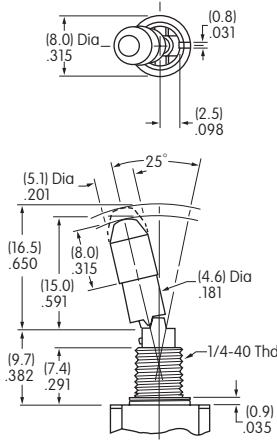

**LL4** 6mm/.291" (7.4mm)  
带螺纹有键槽

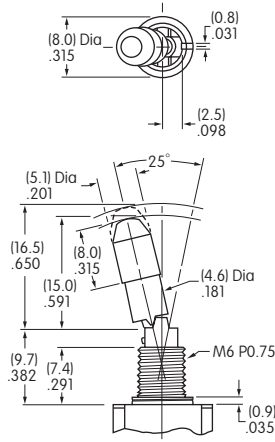

**LL2** 平滑有键槽

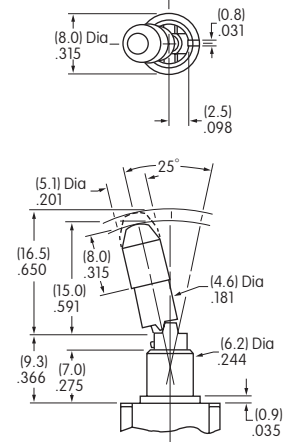

面板厚度带标准配件最大: .047" (1.2mm)

**LL3** .295" (7.5mm)  
防溅入螺纹D形衬套

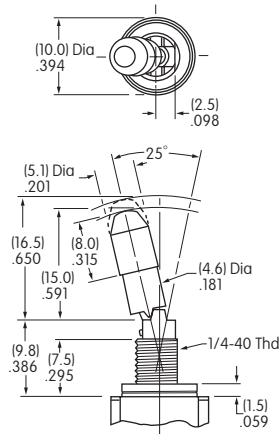

**LL8** 6mm/.295" (7.5mm)  
防溅入螺纹D形衬套

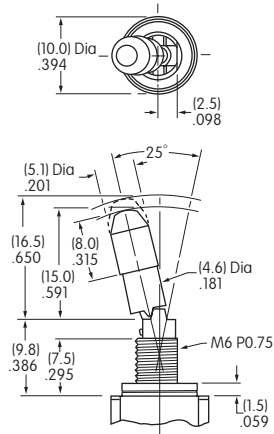

面板厚度带标准配件最大: .047" (1.2mm)

摇杆材质和涂覆: 黄铜镀铬

锁定机构



2点位置锁定



1点位置锁定



2点位置锁定

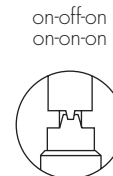

3点位置锁定

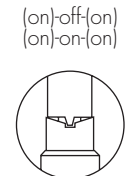

1点位置锁定

摇杆

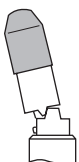

随同AT427型盖帽一起  
供应  
盖帽材质:  
黄铜镀铬

可选的经阳极氧化处理铝质盖帽用的颜色编号

**A** 黑

**C** 红

**G** 蓝

**H** 灰  
(天然铝)

## 触点材质和额定参数

<b>W</b>	银镀银	大功率	6A在125V AC和3A在250V AC
<b>G</b>	铜镀金或黄铜	微小功率	6A在125V AC和3A在250V AC
注：有关运行范围的完整说明请见附录。			
<b>A</b>	银镀金	大功率或微小功率	6A在125V AC 或最大0.4V A在最高28V AC/DC

注：这个双额定值选项适用于具有相同相应的两个或两个以上的相同开关用于微小电流电路和功率电路的情况下。有关双额定值和运行范围的完整说明请见附录。

## 端子

**01** 焊片焊接

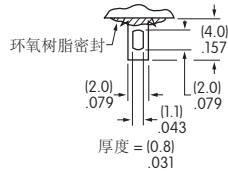

**02** .062" (1.57mm) 宽快速连接

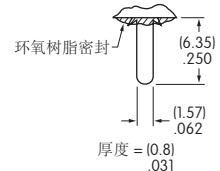

**03** .250" (6.35mm) 直型PC端子

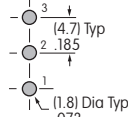
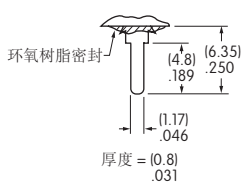

单板

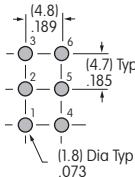

双极

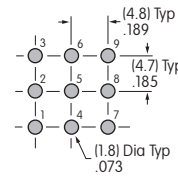

3极

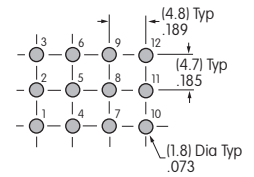

4极

**05** .425" (10.8mm) 绕线或扩展型PC端子

**06** .750" (19.05mm) 绕线或扩展型PC端子

**07** .964" (24.5mm) 绕线或扩展型PC端子

**08** 1.062" (27.0mm) 绕线或扩展型PC端子

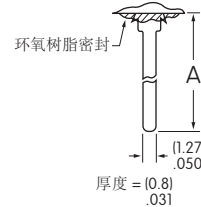

尺寸A = 端子长度，如在端子编号的右侧所示。

如果使用扩展型PC端子，那么请参阅上面的覆盖区。

## 可供选购的盖帽和盖帽颜色

**B** AT415操纵杆盖帽用于S型搬动摇杆

材质：  
聚乙烯

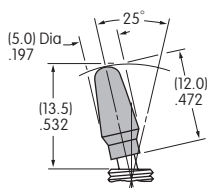

**C** AT444圆锥形盖帽用于S型搬动摇杆

材质：  
聚乙烯

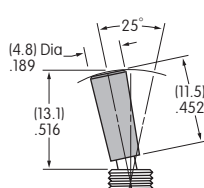

**R** AT434操纵杆盖帽用于B型摇杆

材质：  
聚氯乙烯

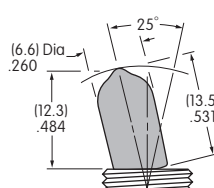

**V** AT406操纵杆盖帽用于B2型摇杆

材质：  
聚氯乙烯

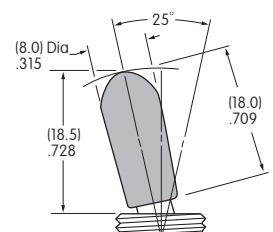

可供盖帽颜色：

- A** 黑
- B** 白
- C** 红
- E** 黄
- F** 绿
- G** 蓝

### 典型开关尺寸

焊片

单极

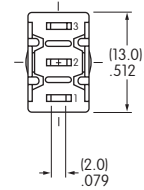
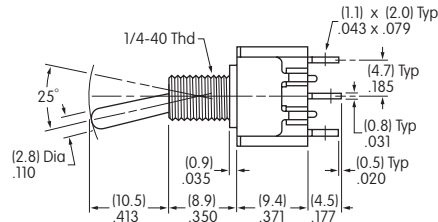
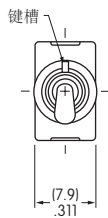

M2012SS1W01

M2011型没有端子1。

焊片

双极

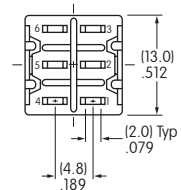
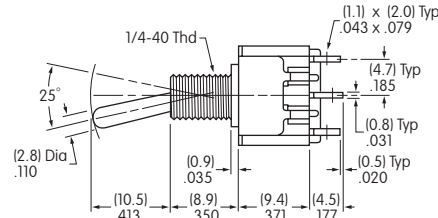
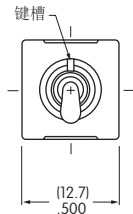

M2022SS1W01

M2021型没有端子1和4。

焊片

3极

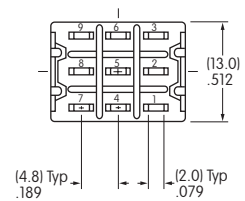
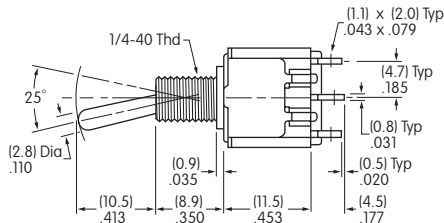
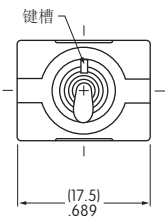

M2032SS1W01

焊片

4极

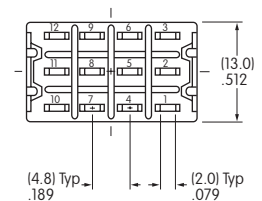
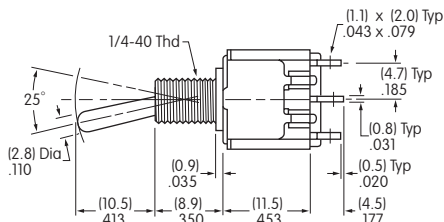
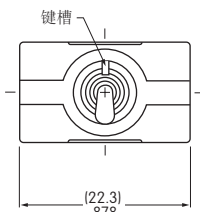

M2042SS1W01

## 小型和大型衬套用的标准配件

AT513H用于英制  
AT513M用于公制  
六角螺母  
黄铜/镍

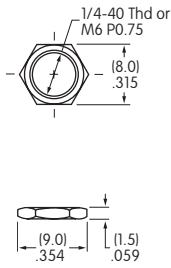

AT507H用于英制  
AT507M用于公制  
锁环  
钢镀锌/铬

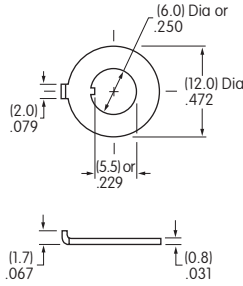

AT509  
锁紧垫圈  
锌/钢镀铬 (不随防溅入型开关提供)

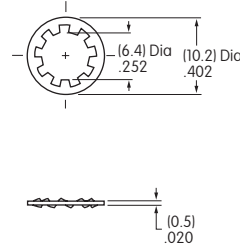

AT516  
O型圈用于防溅入型  
丁腈橡胶

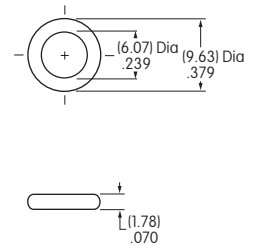

AT503M  
正面六角螺母  
黄铜/铬

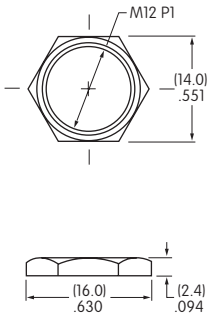

AT506M  
锁环  
钢镀锌/铬

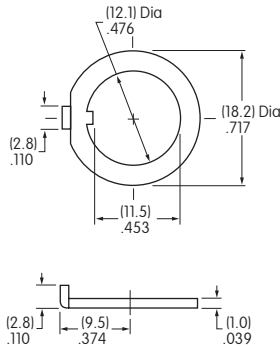

AT508  
锁紧垫圈  
钢镀锌/铬 (不随防溅入型开关提供)

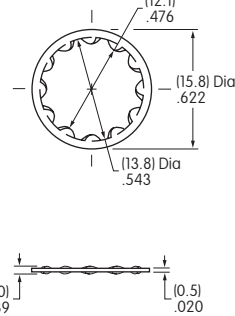

AT527M  
六角螺母  
钢镀镍

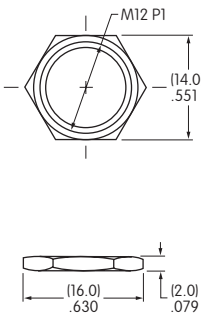

AT401P  
O型圈用于防溅入型  
天然橡胶

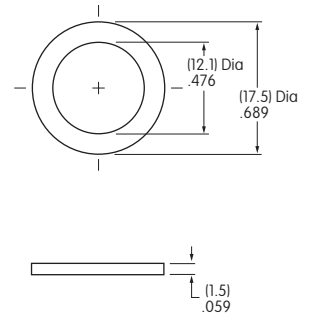

## 可选的防溅入保护罩

有各种各样的螺母和ON-OFF面板可供选购；尺寸示于附件与配件一章中。

AT428 (M-公制 H-英制)  
.445" (11.3mm)  
保护罩用于S型摇杆  
硅橡胶

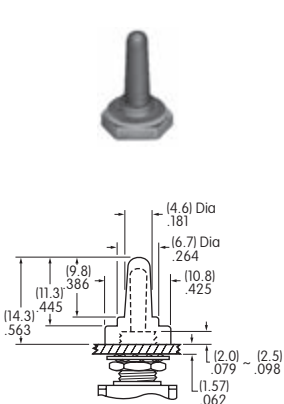

AT402  
.760" (19.3mm)  
保护罩用于B2型摇杆  
硅橡胶

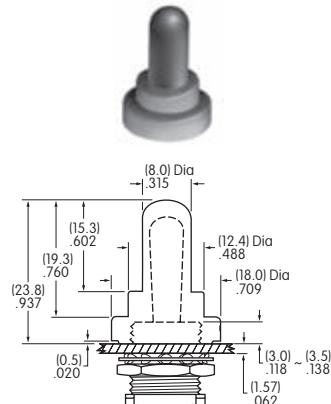

AT402S  
.567" (14.4mm)  
保护罩用于B型摇杆  
硅橡胶

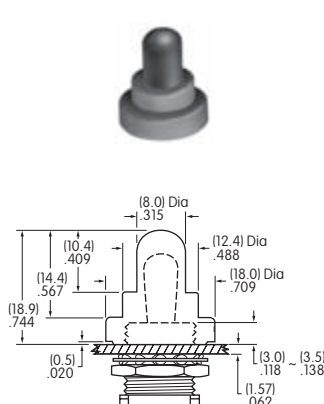

AT401A/H/S  
.461" (11.7mm)  
保护罩用于B2型摇杆  
详情请参阅附件一章。

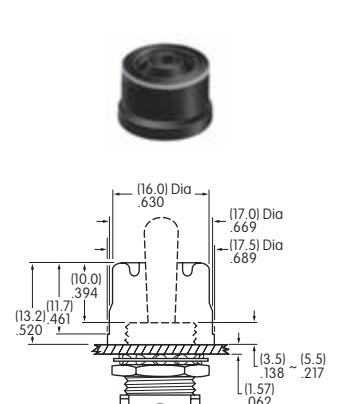

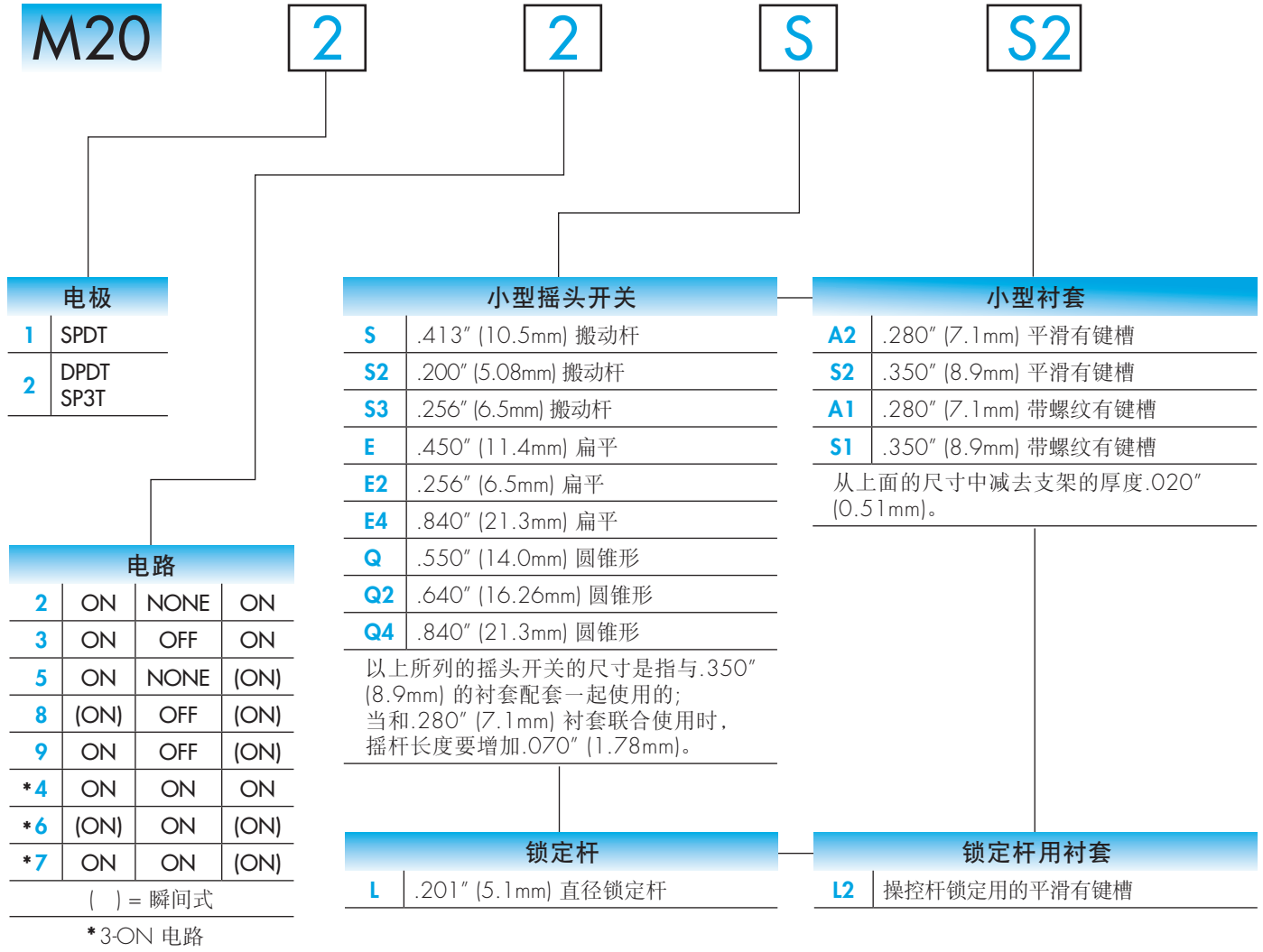

标准摇杆和衬套的组合: SS2 & S2A2

**重要:**

非特别注明外, 开关均无UL、C-UL和CSA标志。特殊型号和额定值在通用规格页上注明。

## 订购举例

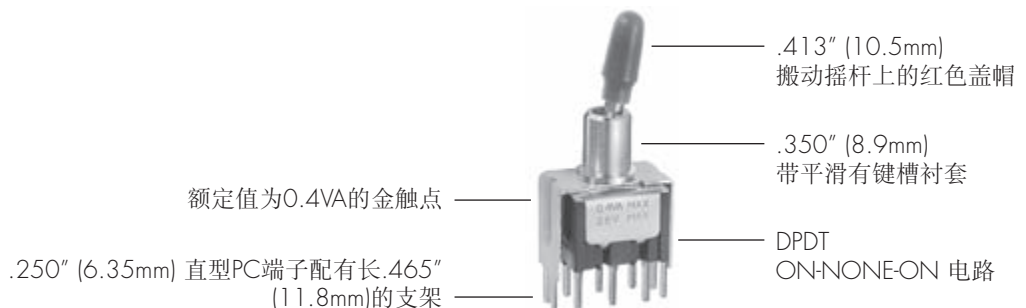

## 电极和电路

电极	型号	摇杆位置 ( ) = 瞬间式			连接的端子			投掷及其示意图
		下 <small>键槽</small>	中	上	下 <small>键槽</small>	中	上	
SP	M2012 M2013 M2015 M2018 M2019	ON ON ON (ON) ON	NONE OFF NONE OFF OFF	ON ON (ON) (ON) (ON)	2-3     	OPEN     	2-1     	SPDT 
DP	M2022 M2023 M2025 M2028 M2029	ON ON ON (ON) ON	NONE OFF NONE OFF OFF	ON ON (ON) (ON) (ON)	2-3 5-6     	OPEN     	2-1 5-4     	DPDT 

对于3掷 (3-on)

电极	型号	连接的端子及其示意图			外部连接
		下	中	上	
SP	M2024 M2026 M2027	ON (ON) ON   2-3 5-6	ON ON ON   2-3 5-4	ON (ON) (ON)   2-1 5-4	SP3T型使用双极基座。  在现场安装时必须进行外部连接。 

## 小型摇头开关

### 重要:

根据所选衬套选定摇杆长度。所有插图均以.350"(8.9mm)长度衬套为例。当使用.280"(7.1mm)长度衬套时，摇杆长度增加.070"(1.78mm)。

### 标准材质和涂覆:

黄铜镀铬抛光  
关于其他可选的涂覆，请与厂家联系。

**S** .413" (10.5mm) 搬动杆

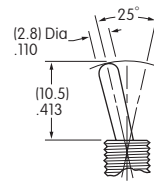

**S2** .200" (5.08mm) 搬动杆

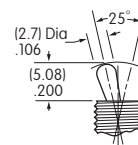

**S3** .256" (6.5mm) 搬动杆

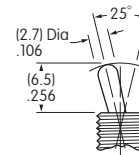

**E** .450" (11.4mm) 扁平

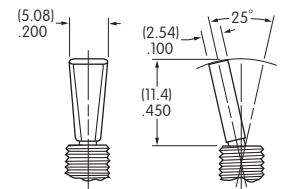

**E2** .256" (6.5mm) 扁平

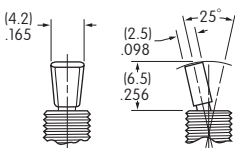

**E4** .840" (21.3mm) 扁平

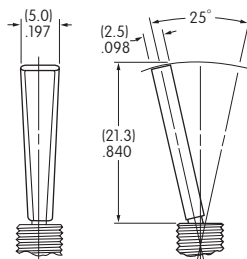

**Q** .550" (14.0mm) 圆锥形

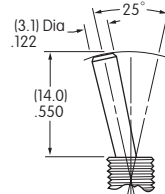

**Q2** .640" (16.26mm) 圆锥形

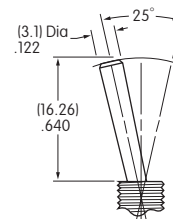

**Q4** .840" (21.3mm) 圆锥形

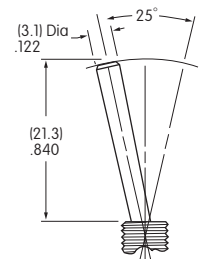

小型衬套

**A2** .280" (7.1mm)  
平滑有键槽

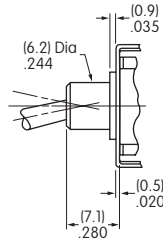
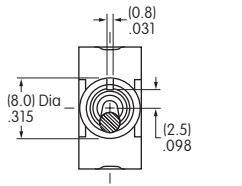

**S2** .350" (8.9mm)  
平滑有键槽

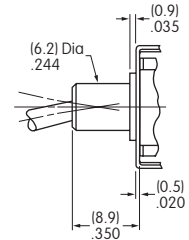
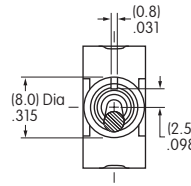

当使用该衬套时，摇杆长度增加.070" (1.78mm)。

**A1** .280" (7.1mm)  
带螺纹有键槽

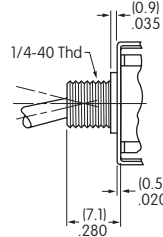
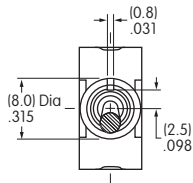

**S1** .350" (8.9mm)  
带螺纹有键槽

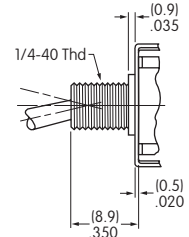
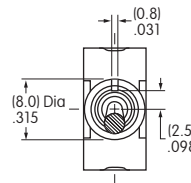

当使用该衬套时，摇杆长度增加.070" (1.78mm)。  
面板厚度带标准配件最大：.031" (0.8mm)

面板厚度  
带标准配件最大：.102" (2.6mm)

面板裁切

用于A2, S2, A1,  
或S1型的有键槽  
衬套

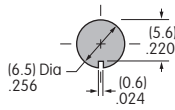

用于A1或  
S1型有锁环衬套

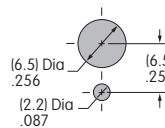

标准配件：

- 2个六角螺母 (AT513H)
- 1个锁紧垫圈 (AT509)
- 1个锁环 (AT507H)

关于尺寸，请参阅附件和配件一章。

锁定杆和衬套

**LL2** 平滑有键槽

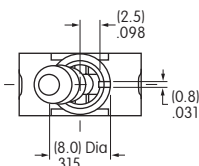

用于锁定杆的盖帽

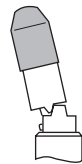

随同AT427型盖帽一起提供  
材质和涂覆：  
黄铜镀镍

摇杆材质和涂覆：  
黄铜镀铬

锁定机构

on-none-on

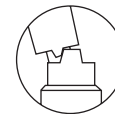

2点位置锁定

on-none-(on)



1点位置锁定

颜色编号用于  
可选的经阳极氧化处理铝盖帽

**A** 黑

**G** 蓝

**C** 红

**H** 灰(天然铝)

on-off-(on)  
on-on-(on)

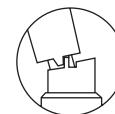

2点位置锁定

on-off-on  
on-on-on

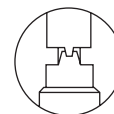

3点位置锁定

(on)-off-(on)  
(on)-on-(on)

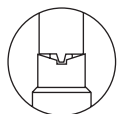

1点位置锁定

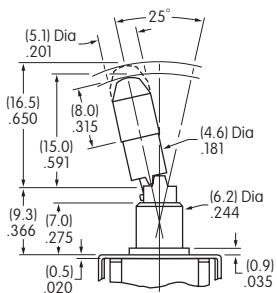



## 触点材质和额定参数

<b>W</b>	银镀银	大功率	6A在125V AC和3A在250V AC
<b>G</b>	黄铜或铜镀金	微小功率	最大0.4VA 在最高28V AC/DC
<b>A</b>	银镀金	大功率 或微小功率	6A在125V AC 或最大0.4VA在最高28V AC/DC

注：有关有关运行范围的完整说明请见附录。

注：这个双额定值选项适用于具有相同应用的两个或两个以上的相同开关用于微小电流电路和功率电路的情况下。有关双额定值和运行范围的完整说明请见附录。

## 端子

直型PC端子安装有支架

直型PC端子安装有加固支架

13	15	17	23	25	26
.250" (6.35mm) 端子带	.425" (10.8mm) 端子带	.964" (24.5mm) 端子带	.250" (6.35mm) 端子带	.425" (10.8mm) 端子带	.750" (19.05mm) 端子带
.465" (11.8mm) 支架	.630" (16.0mm) 支架	1.150" (29.2mm) 支架	.465" (11.8mm) 支架	.630" (16.0mm) 支架	.953" (24.2mm) 支架

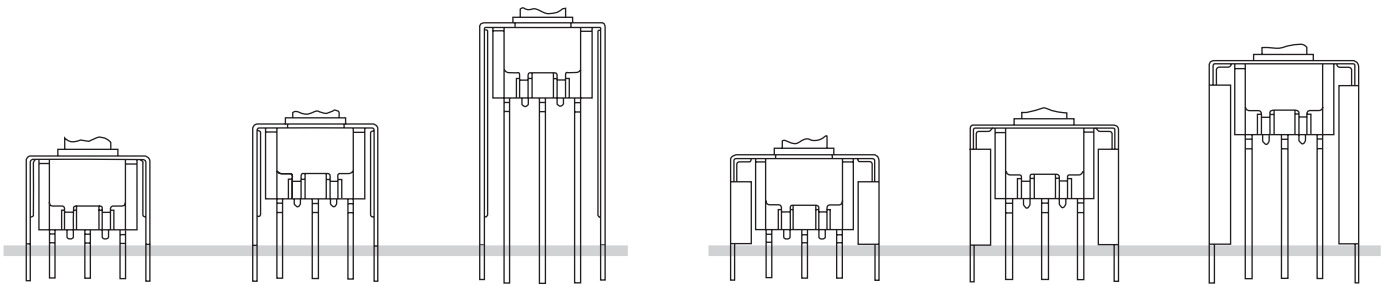

印刷电路板覆盖区在以下典型开关尺寸页上。

## 可供选购的盖帽和盖帽颜色

**B** AT415  
用于S型搬动杆摇头开关

材质：  
聚乙烯

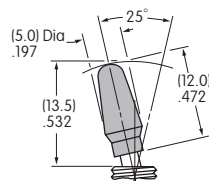

**C** AT444  
用于S型搬动杆摇头开关的  
圆锥形盖帽

材质：  
聚乙烯

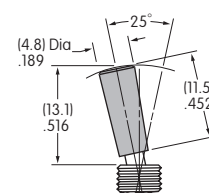

可供选择的  
盖帽颜色：



黑



白



红



黄



绿



蓝

## 典型开关尺寸

直型PC端子·支架

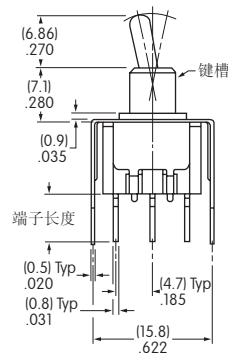
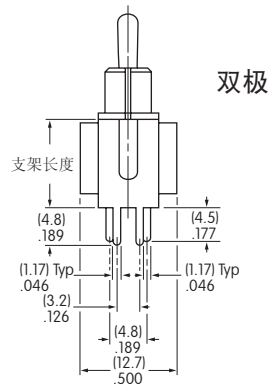
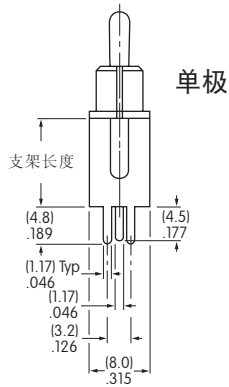

M2012S2A2G13

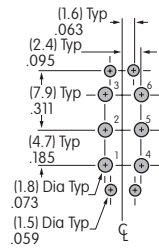
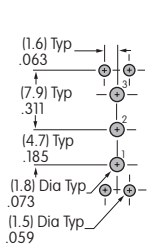

端子编号:	端子长度:	支架长度:
<b>13</b>	.250" (6.35mm)	.465" (11.8mm)
<b>15</b>	.425" (10.8mm)	.630" (16.0mm)
<b>17</b>	.964" (24.5mm)	1.150" (29.2mm)

直型PC端子·加固支架

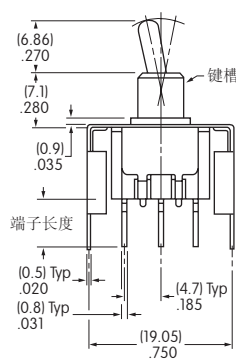
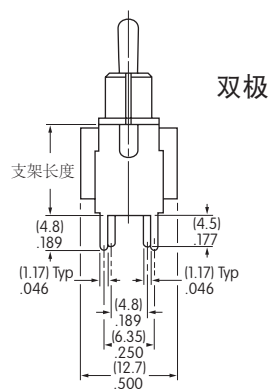
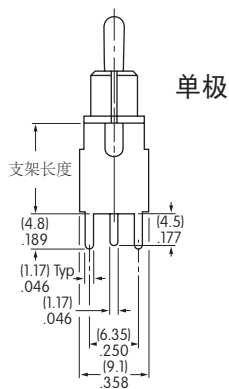

M2012S2A2G23

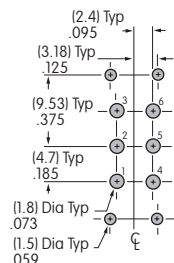
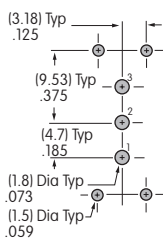

端子编号:	端子长度:	支架长度:
<b>23</b>	.250" (6.35mm)	.465" (11.8mm)
<b>25</b>	.425" (10.8mm)	.630" (16.0mm)
<b>26</b>	.750" (19.05mm)	.953" (24.2mm)



**重要:**

非特别注明外, 开关均无UL、C-UL和CSA标志。特殊型号和额定值在通用规格页上注明。

### 订购举例

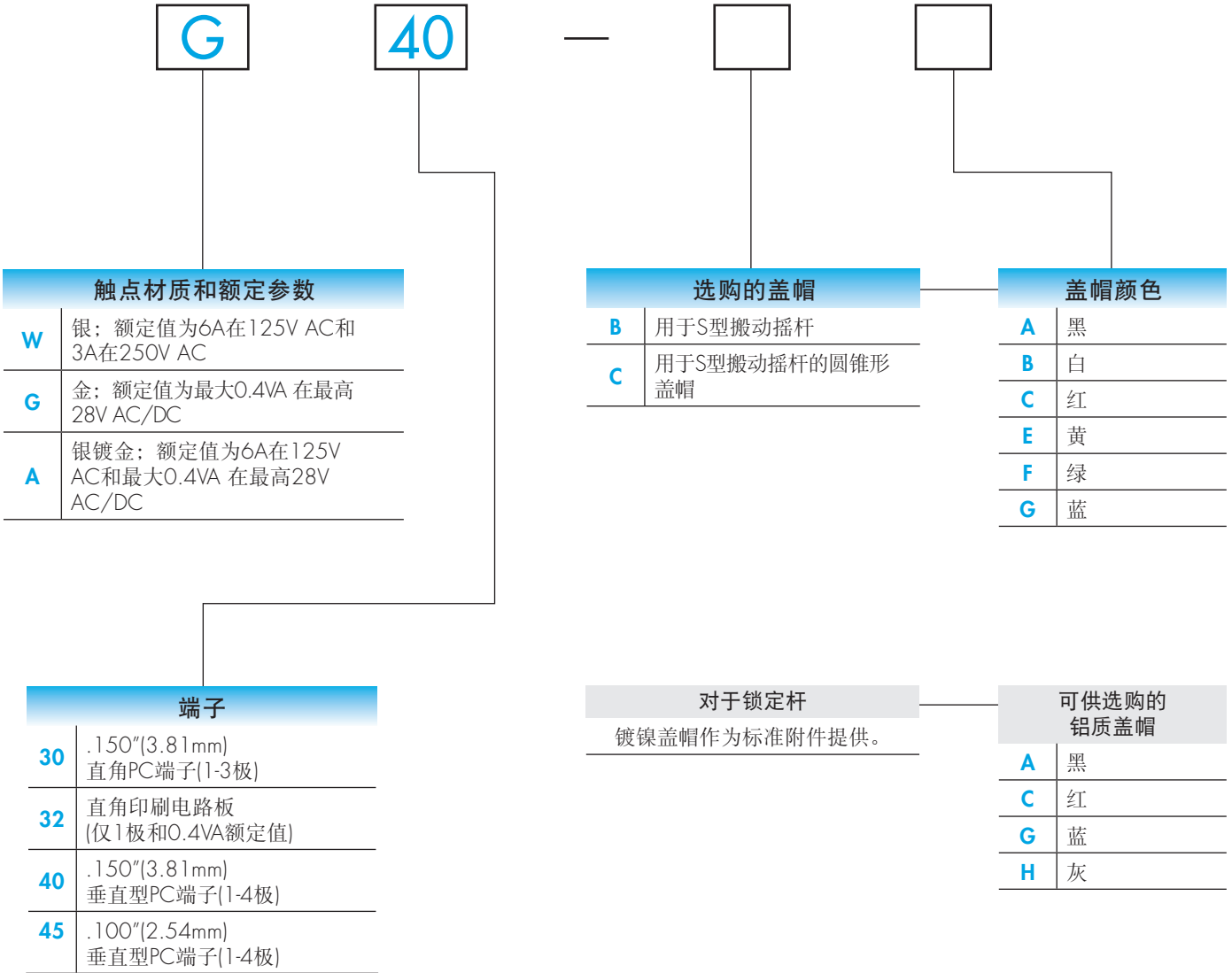

### 典型订购举例

M2012S2A2G40

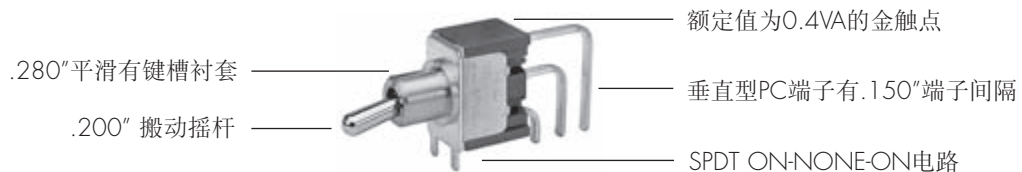

### 电极和电路

电极	型号	摇杆位置 ( ) = 瞬间式			连接的端子			投掷及其示意图
		下 	中 	上 	下 	中 	上 	
SP	* M2012 M2013 M2015 * M2018 M2019	ON ON ON (ON) ON	NONE OFF NONE OFF OFF	ON ON (ON) ON (ON)	2-3	OPEN	2-1	SPDT 
DP	* M2022 M2023 M2025 * M2028 M2029	ON ON ON (ON) ON	NONE OFF NONE OFF OFF	ON ON (ON) ON (ON)	2-3 5-6	OPEN	2-1 5-4	DPDT 
3P	M2032 M2033 M2035 M2038 M2039	ON ON ON (ON) ON	NONE OFF NONE OFF OFF	ON ON (ON) ON (ON)	2-3 5-6 8-9	OPEN	2-1 5-4 8-7	3PDT 
4P	M2042 M2043 M2045 M2048 M2049	ON ON ON (ON) ON	NONE OFF NONE OFF OFF	ON ON (ON) ON (ON)	2-3 5-6 8-9 11-12	OPEN	2-1 5-4 8-7 11-10	4PDT 

注: 端子编号并未实际印制在开关上。  
\* 对于垂直安装SP和DP, 根据需求可供反作用电路。

对于3掷(3-On)

电极	型号	下	中	上	连接的端子及其示意图		
SP	M2024 M2026 M2027	ON (ON) ON	ON ON ON	ON (ON) (ON)			
DP	M2044 M2046 M2047	ON (ON) ON	ON ON ON	ON (ON) (ON)			

SP3T型使用双极基座。

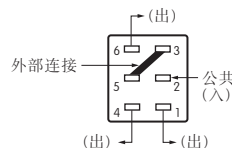

在现场安装时必须进行外部连接。

DP3T型使用4极基座。

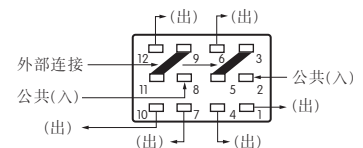

在现场安装时必须进行外部连接。

## 小型摇头开关

### 重要:

根据所选衬套选定摇杆长度。  
所有插图均以.350"(8.9mm)长度衬套为例。  
当使用.280"(7.1mm)长度衬套时，  
摇杆长度增加.070"(1.78mm)。

**S** .413" (10.5mm)  
搬动杆

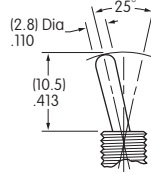

**S2** .200" (5.08mm)  
搬动杆

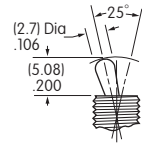

**S3** .256" (6.5mm)  
搬动杆

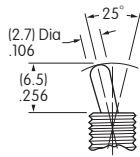

**E** .450" (11.4mm)  
扁平

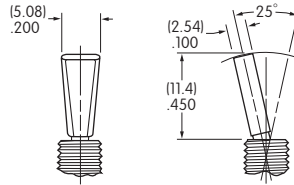

**E2** .256" (6.5mm)  
扁平

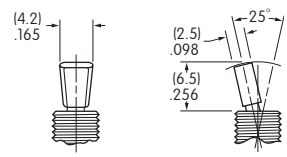

标准材质和涂覆: 黄铜镀铬抛光  
关于其他可选的涂覆, 请与厂家联系。

## 小型衬套

**A2** .280" (7.1mm)  
平滑有键槽

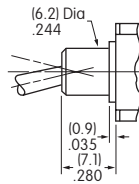
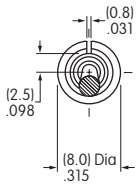

**S2** .350" (8.9mm)  
平滑有键槽

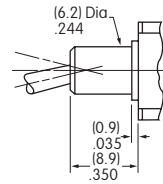
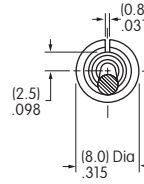

当使用该衬套时, 摇杆长度增加.070"(1.78mm)。

**A1** .280" (7.1mm)  
带螺纹有键槽

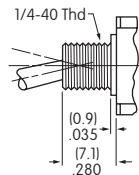
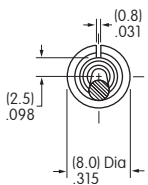

**S1** .350" (8.9mm)  
带螺纹有键槽

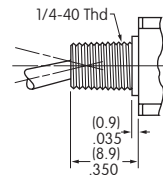
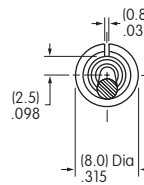

当使用该衬套时, 摇杆长度增加.070"(1.78mm)。  
面板厚度带标准配件最大: .031" (0.8mm)

面板厚度  
带标准配件最大: .102" (2.6mm)

## 面板裁切

用于A2,S2,A1,或  
S1型的有键槽的  
衬套

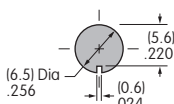

用于A1或S1型的  
有锁环的衬套

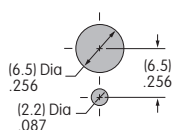

### 标准配件:

- 2个六角螺母(AT513H)
- 1个锁紧垫圈(AT509)
- 1个锁环(AT507H)

关于尺寸, 请参阅附件与配件的一章。

## 锁定杆和衬套

### LL2 平滑有键槽

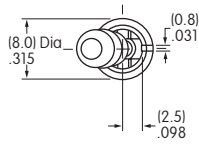

用于锁定杆的盖帽

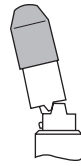

与盖帽AT427一起提供  
材质和涂覆:

黄铜镀镍

摇杆材质和涂覆:

黄铜镀铬

锁定机构

on-none-on

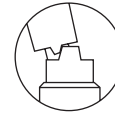

2点位置锁定

on-none(on)



1点位置锁定

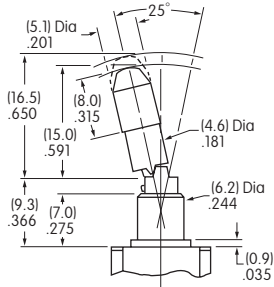

可选的经阳极氧化处理铝质盖帽用的  
颜色编号

**A** 黑

**G** 蓝

**C** 红

**H** 灰(天然铝)

on-off(on)  
on-on(on)



2点位置锁定

on-off-on  
on-on-on

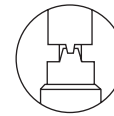

3点位置锁定

(on)-off(on)  
(on)-on(on)

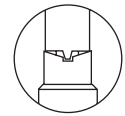

1点位置锁定

## 触点材质和额定参数

**W** 银镀银

大功率

6A在125V AC和3A在250V AC

**G** 黄铜或铜镀金

微小功率

最大0.4VA 在最高28V AC/DC

注: 有关运行范围的完整说明请见附录。

**A** 银镀金

大功率或微小功率

6A在125V AC  
或最大0.4VA在最高28V AC/DC

注: 这个双额定值选项适用于具有相同应用的中两个或两个以上的开关同时用于微小电路和功率电路的情况。  
有关双额定值和运行范围的完整说明请见附录。

## 端子

**30** .150" (3.81mm)  
直角PC端子(1-3 极)

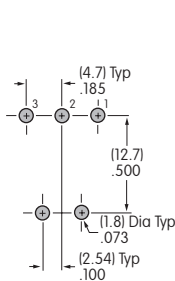
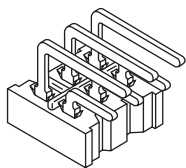

单极

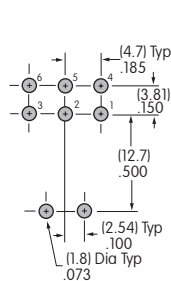

双极

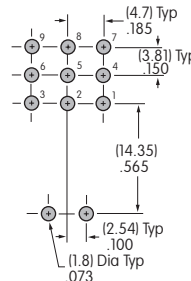

3极

**32** 直角印刷电路板  
带反作用电路  
(仅1极和0.4VA额定值)

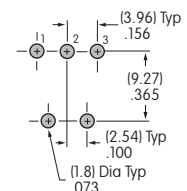
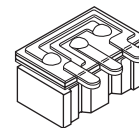

端子尺寸示于后面典型开关尺寸页中。

### 端子(续)

**40** .150" (3.81mm)  
垂直型PC端子(1~4极)

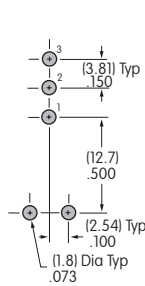
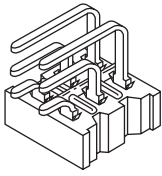

单板

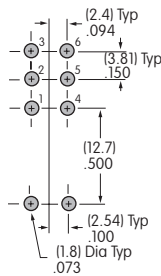

双极

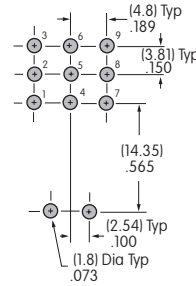

3极

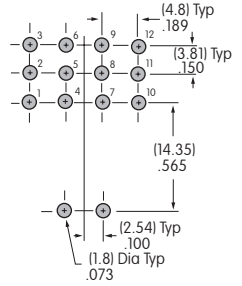

4极

**45** .100" (2.54mm)  
垂直型PC端子(1~4极)

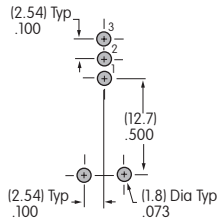
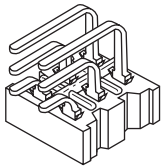

单板

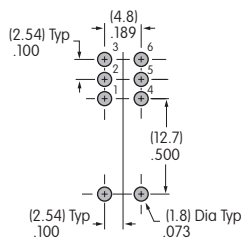

双极

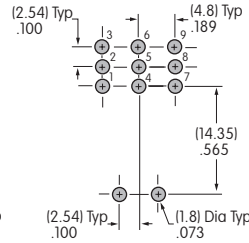

3极

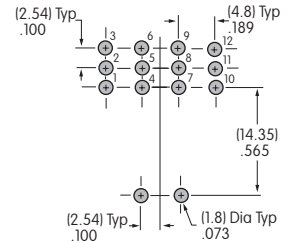

4极

端子尺寸如后面典型开关尺寸页所示。

### 选购的盖帽和盖帽颜色

**B** AT415  
用于S型搬动摇杆

材质：  
聚乙烯

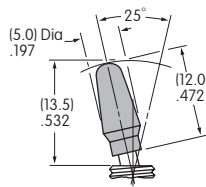

**C** AT444  
用于S型搬动摇杆的圆锥形盖帽

材质：  
聚乙烯

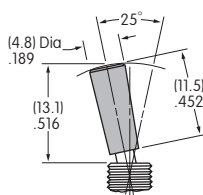

可供颜色

<b>A</b> 黑	<b>E</b> 黄
<b>B</b> 白	<b>F</b> 绿
<b>C</b> 红	<b>G</b> 蓝

### 标准配件

AT513H用于英制  
AT513M用于公制  
六角螺母 (每个开关2个)  
黄铜/镍

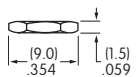
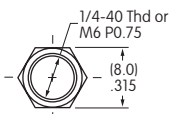

AT507H用于英制  
AT507M用于公制  
锁环 (每个开关1个)  
钢镀锌/铬

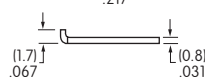
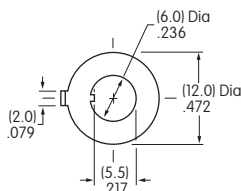

AT509  
锁紧垫圈  
(除防溅入型开关以外, 每个开关  
配有1个)  
钢镀锌/铬

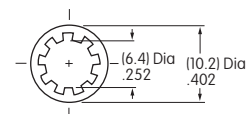



A

摇头开关

## 典型开关尺寸

.150" (3.81mm) 直角PC端子

单极

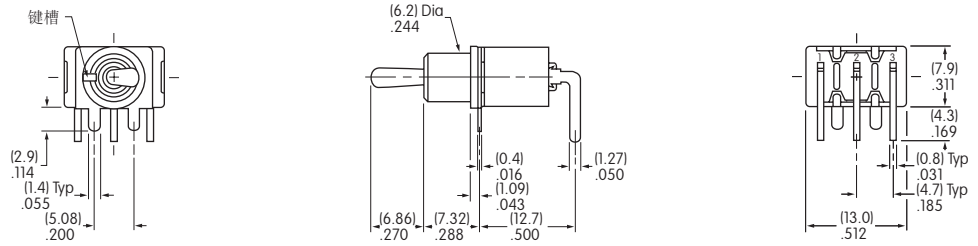
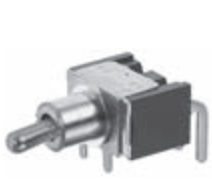

M2012S2A2G30

.150" (3.81mm) 直角PC端子

双极

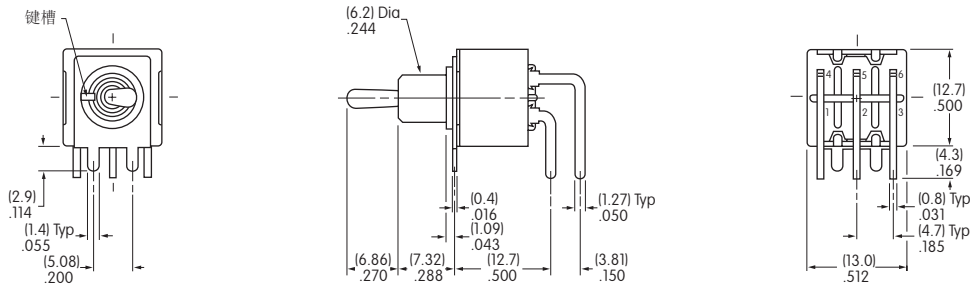

M2022S2A2G30

.150" (3.81mm) 直角PC端子

3极

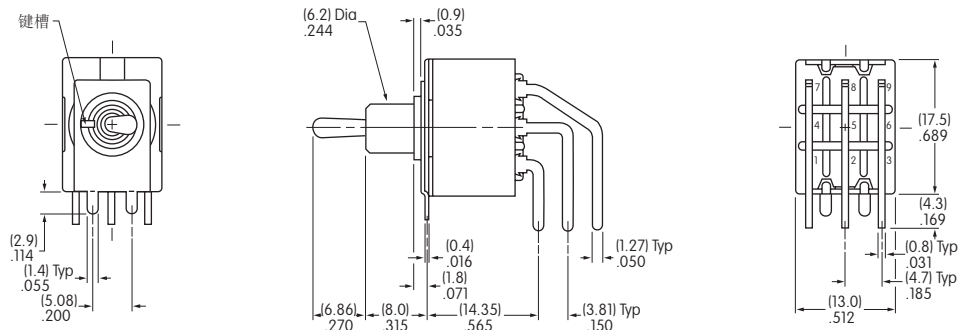

M2032S2A2G30

直角PC端子

单极·反作用电路

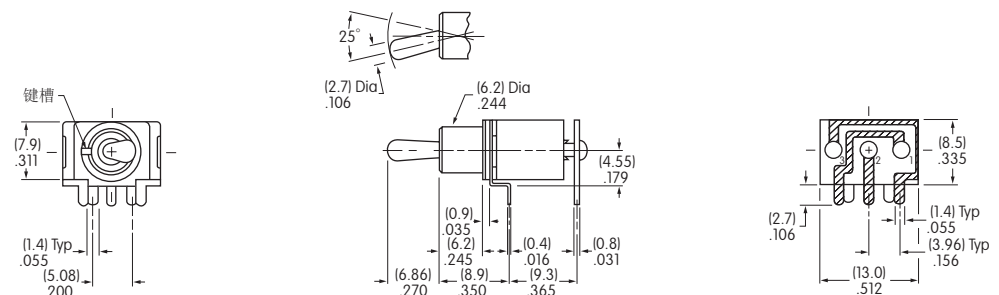

M2012S2A2G32

## 典型开关尺寸

单极

.150" (3.81mm) 垂直型PC端子

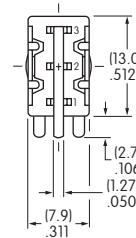
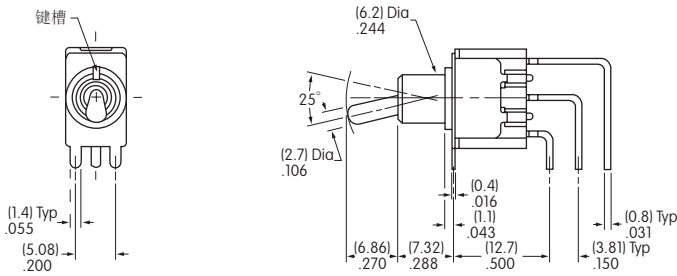

M2012S2A2G40

双极

.150" (3.81mm) 垂直型PC端子

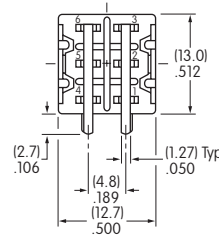
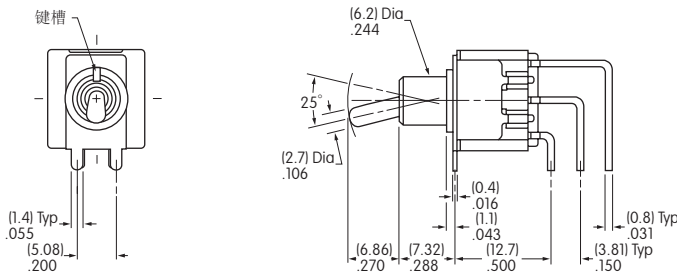

M2022S2A2G40

3极

.150" (3.81mm) 垂直型PC端子

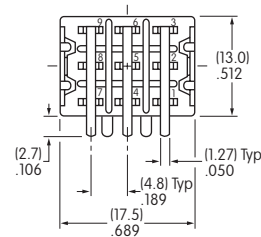
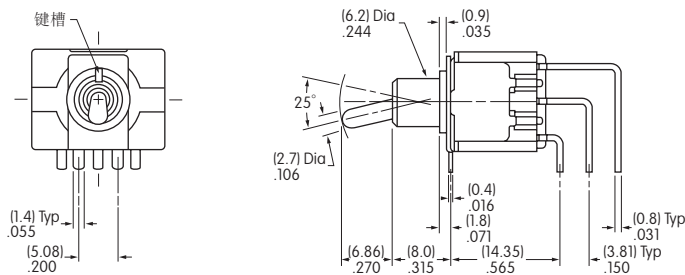

M2032S2A2G40

4极

.150" (3.81mm) 垂直型PC端子

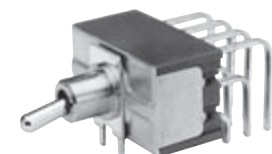
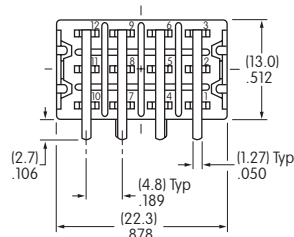
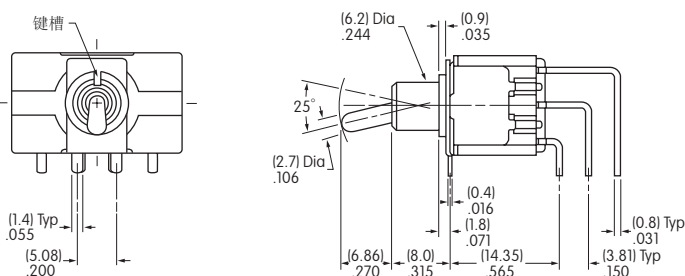

M2042S2A2G40

A

摇头开关

## 典型开关尺寸

.100" (2.54mm) 垂直型PC端子

单极

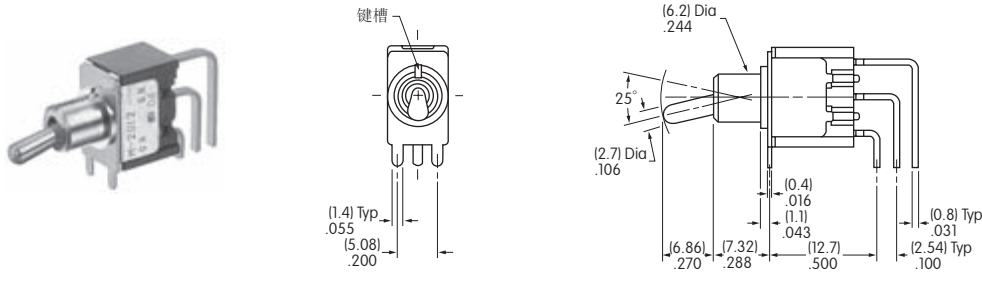

M2012S2A2G45

.100" (2.54mm) 垂直型PC端子

双极

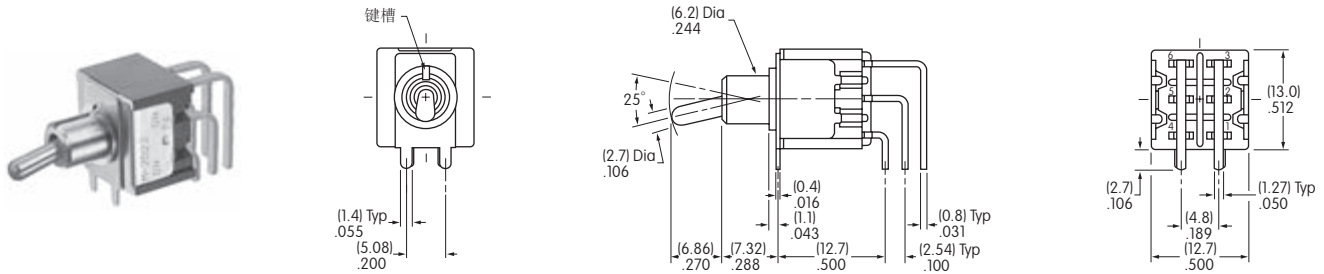

M2022S2A2G45

.100" (2.54mm) 垂直型PC端子

3极

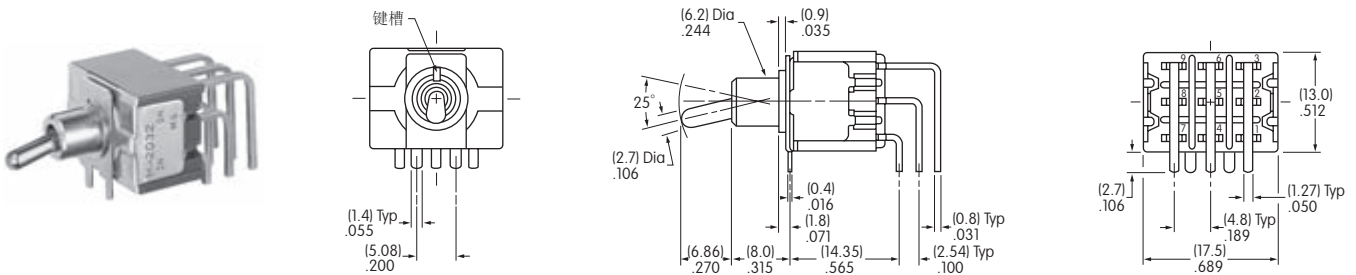

M2032S2A2G45

.100" (2.54mm) 垂直型PC端子

4极

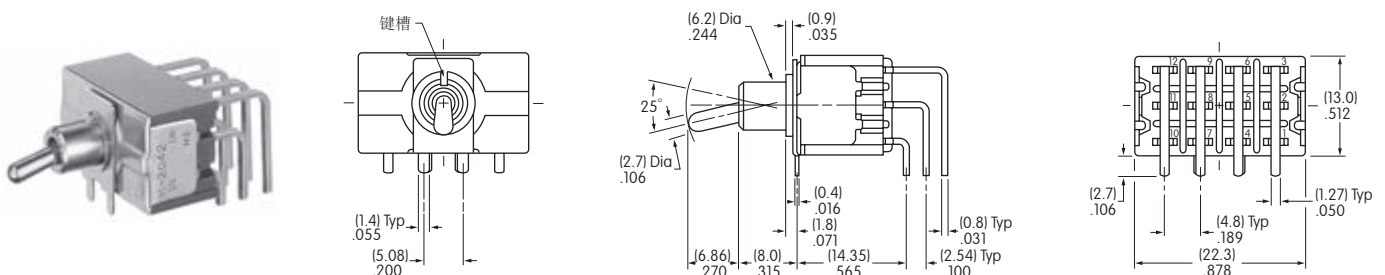

M2042S2A2G45