

Features

- Low start-up voltage: 0.7V (Typ.)
- High efficiency: $1.8V \leq V_{OUT} \leq 2.2V$ upper 80%,
 $2.7V \leq V_{OUT} \leq 5.0V$ upper 85% (Typ.)
- High output voltage accuracy: $\pm 2.5\%$
- Output voltage: 1.8V, 2.2V, 2.7V, 3.0V, 3.3V, 3.7V, 5.0V
- Output current up to 100mA
- Ultra low supply current I_{DD} : 4 μ A (Typ.)
- Low ripple and low noise
- Low shutdown current: 0.1 μ A (Typ.)
- Package types: 3-pin SOT89, 3-pin SOT23 and 5-pin SOT23

Applications

- Palmtops/PDAs
- Portable communicators/Smartphones
- Cameras/Camcorders
- Battery-powered equipment

General Description

The HT77xxS devices are a high efficiency PFM synchronous step-up DC-DC converter series which are designed to operate with both wire wound chip power inductors and also with multi-layered chip power inductors. The device series have the advantages of extremely low start-up voltage as well as high output voltage accuracy. Being manufactured using CMOS technology ensures ultra low supply current. Because of their higher operating frequency, up to 500 kHz, the devices have the benefits of requiring smaller outline type lower value external inductors and capacitors. The higher operating frequency also offers the advantages of much reduced audio frequency noise. The devices require only three external components to provide a fixed output voltage of 1.8V, 2.2V, 2.7V, 3.0V, 3.3V, 3.7V or 5.0V.

The HT77xxS devices include an internal oscillator, PFM control circuit, driver transistor, reference voltage unit and a high speed comparator. They employ pulse frequency modulation techniques, to obtain minimum supply current and ripple at light output loading. These devices are available in space saving 3-pin SOT89, 3-pin SOT23 and 5-pin SOT23 packages. For SOT23-5 package types, they also include an internal chip enable function to reduce power consumption when in the shutdown mode.

Selection Table

Part No.	Output Voltage	Package	Marking
HT7718S	1.8V	SOT89 SOT23 SOT23-5	HT77xxS (for SOT89) 7xxS (for SOT23) 7xxS (for SOT23-5)
HT7722S	2.2V		
HT7727S	2.7V		
HT7730S	3.0V		
HT7733S	3.3V		
HT7737S	3.7V		
HT7750S	5.0V		

Note: "xx" stands for output voltages.

Block Diagram

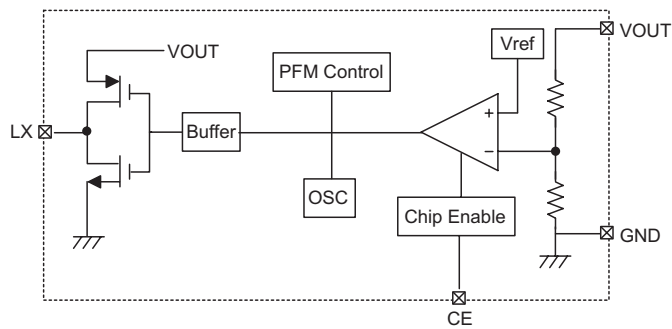

Pin Assignment

SOT89

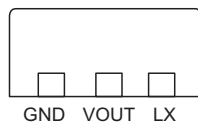
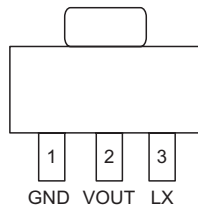

SOT23

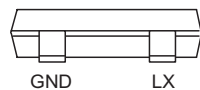
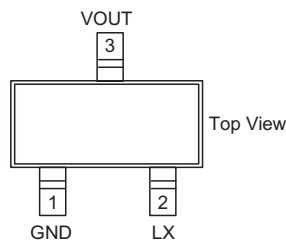

SOT23-5

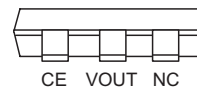
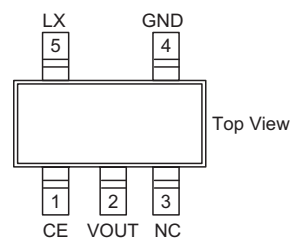

Pin Description

Pin No.			Pin Name	Description
SOT89	SOT23	SOT23-5		
—	—	1	CE	Chip enable pin, high active
2	3	2	VOUT	DC/DC converter output monitoring pin
—	—	3	NC	No connection
1	1	4	GND	Ground pin
3	2	5	LX	Switching pin

Absolute Maximum Ratings

Maximum Input Supply Voltage 6.5V Storage Temperature -50°C to 125°C
 Ambient Temperature Range -40°C to 85°C

Note: These are stress ratings only. Stresses exceeding the range specified under "Absolute Maximum Ratings" may cause substantial damage to the device. Functional operation of this device at other conditions beyond those listed in the specification is not implied and prolonged exposure to extreme conditions may affect device reliability.

Thermal Information

Symbol	Parameter	Package	Max.	Unit
θ_{JA}	Thermal Resistance (Junction to Ambient) (Assume no ambient airflow, no heat sink)	SOT89	300	°C/W
		SOT23	330	°C/W
		SOT23-5	320	°C/W
P_D	Power Dissipation	SOT89	0.33	W
		SOT23	0.30	W
		SOT23-5	0.31	W

Note: P_D is measured at $T_a=25^\circ\text{C}$

Electrical Characteristics

$T_a = 25^\circ\text{C}$; $V_{IN} = V_{OUT} \times 0.6$; $I_{OUT} = 10\text{mA}$; unless otherwise specified

Symbol	Parameter	Test Conditions	Min.	Typ.	Max.	Unit
V_{IN}	Input Voltage	—	—	—	6.0	V
ΔV_{OUT}	Output Voltage Tolerance		-2.5	—	+2.5	%
V_{START}	Starting Voltage	$V_{IN}: 0 \text{ to } 2\text{V}, I_{OUT} = 1\text{mA}$	—	0.7	0.9	V
V_{HOLD}	Voltage Hold	$V_{IN}: 2 \text{ to } 0\text{V}, I_{OUT} = 1\text{mA}$	—	0.7	—	V
I_{DD}	Supply Current	Measured at VOUT pin when $V_{OUT} + 0.5\text{V}$	—	4	7	μA
I_{SHDN}	Shutdown Current	CE= GND	—	0.1	1.0	μA
V_{IH}	CE High Threshold	—	1.5	—	—	V
V_{IL}	CE Low Threshold		—	—	0.4	V
I_{LEAK}	LX Leakage Current	Add 5.5V at VOUT pin, 4V at LX pin. Measured at LX pin.	—	0.05	1	μA
F_{OSC}	Oscillator Frequency	Measured at LX pin when $V_{OUT} \times 0.95$	—	500	—	kHz
D_{OSC}	Oscillator Duty Cycle		70	80	—	%
η	Efficiency	$1.8\text{V} \leq V_{OUT} \leq 2.2\text{V}$	—	80	—	%
		$2.7\text{V} \leq V_{OUT} \leq 5.0\text{V}$	—	85	—	%

Note: Absolute maximum ratings indicate limits beyond which damage to the device may occur. Operating Ratings indicate conditions for which the device is intended to be functional, but do not guarantee specific performance limits. The guaranteed specifications apply only for the test conditions listed.

Application Circuits

Without CE Pin

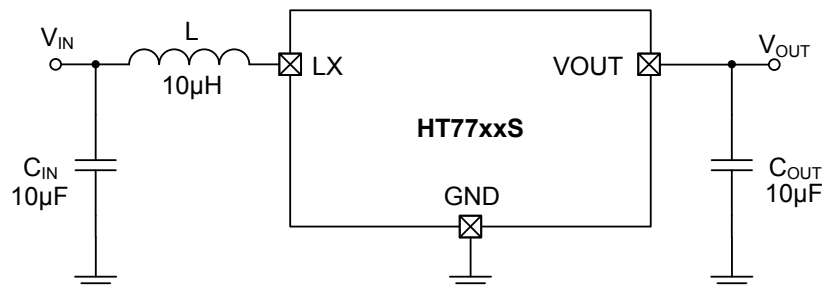

With CE Pin

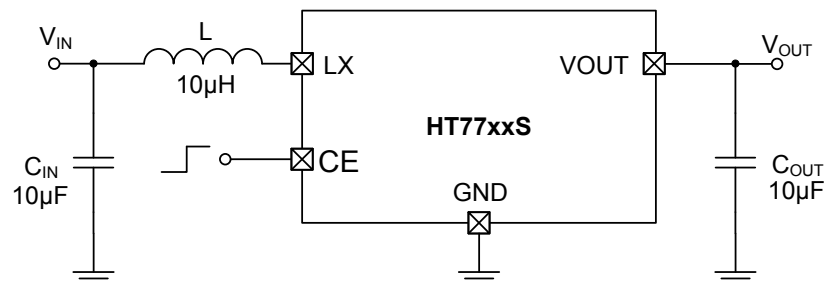
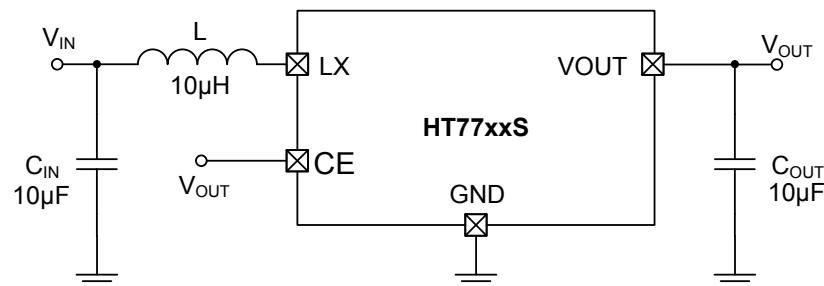

List of Components

Component Reference	Part Number	Manufacturer	Value
C_{IN}, C_{OUT}	GJ831CR61E106KE83L	Murata	10µF, 25V. X5R Ceramic
L	SR0302100MLB	ABC Taiwan Electronics Corp.	10µH, $R_{DC}=0.25\Omega$. Wire Wound Chip Power Inductor
L	LBC3225T100MR	TAIYO YUDEN	10µH, $R_{DC}=0.133\Omega$. Multi-layered Chip Power Inductor

Functional Description

The HT77xxS is a constant on time synchronous step-up converter, which uses a pulse frequency modulation (PFM) controller scheme. The PFM control scheme is inherently stable. The required input/output capacitor and inductor selections will not create situations of instability.

The device includes a fully integrated synchronous rectifier which reduces costs (includes reduce L and C sizes, eliminates Schottky diode cost etc.) and board area.

Low Voltage Start-up

The devices have a very low start up voltage down to 0.7V. When power is first applied, the synchronous switch will be initially off but energy will be transferred to the load through its intrinsic body diode.

Shutdown

During normal device operation, the CE pin should be either high or connected to the VOUT pin or the V_{IN} power source. When the device is in the shutdown mode, that is when the CE pin is pulled low, the internal circuitry will be switched off. During shutdown, the PMOS power transistor will be switched off.

Synchronous Rectification

A dead time exists between the N channel and P channel MOSFET switching operations. In synchronous rectification, the P channel is replaced by a Schottky diode. Here the P channel switch must be completely off before the N channel switch is switched on. After each cycle, a 30ns delay time is inserted to ensure the N channel switch is completely off before the P channel switch is switched on to maintain a high efficiency over a wide input voltage and output power range.

Application Information

Inductor Selection

Selecting a suitable inductor is an important consideration as it is usually a compromise situation between the output current requirements, the inductor saturation limit and the acceptable output voltage ripple. Lower values of inductor values can provide higher output currents but will suffer from higher ripple voltages and reduced efficiencies. Higher inductor values can provide reduced output ripple voltages and better efficiencies, but will be limited in their output current capabilities. For all inductors it must be noted however that lower core losses and lower DC resistance values will always provide higher efficiencies.

The peak inductor current can be calculated using the following equation:

$$I_{L(\text{PEAK})} = \frac{V_{\text{OUT}} \times I_{\text{OUT}}}{V_{\text{IN}} \times \eta} + \frac{V_{\text{IN}} \times (V_{\text{OUT}} - V_{\text{IN}})}{2 \times V_{\text{OUT}} \times L \times f_{\text{OSC}}}$$

Where

- V_{IN} = Input Voltage
- V_{OUT} = Output Voltage
- I_{OUT} = Output Current
- η = Efficiency
- L = Inductor

Capacitor Selection

As the output capacitor selected affects both efficiency and output ripple voltage, it must be chosen with care to achieve best results from the converter. Output voltage ripple is the product of the peak inductor current and the output capacitor equivalent series resistance or ESR for short. It is important that low ESR value capacitors are used to achieve optimum performance. One method to achieve low ESR values is to connect two or more filter capacitors in parallel. The capacitor values and rated voltages are only suggested values.

Layout Considerations

Circuit board layout is a very important consideration for switching regulators if they are to function properly.

Poor circuit layout may result in related noise problems. In order to minimise EMI and switching noise, note the following guidelines:

- All tracks should be as wide as possible.
- The input and output capacitors should be placed as close as possible to the VIN, VOUT and GND pins.
- A full ground plane is always helpful for better EMI performance.

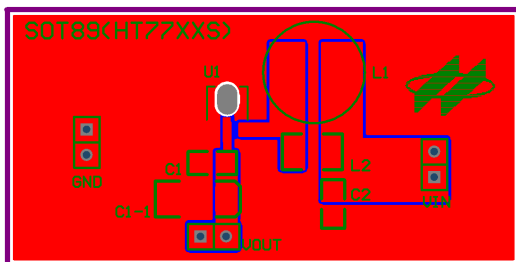

Top Layer

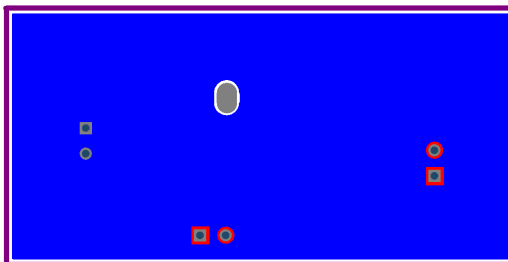

Bottom Layer

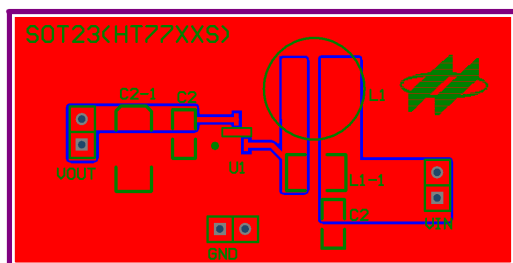

Top Layer

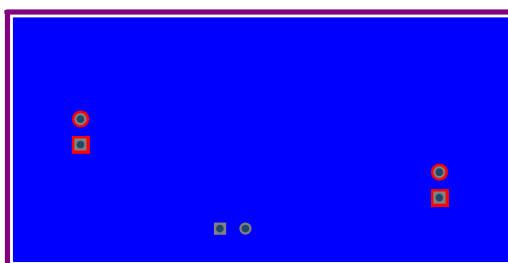

Bottom Layer

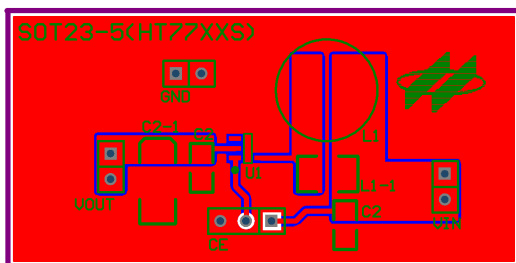

Top Layer

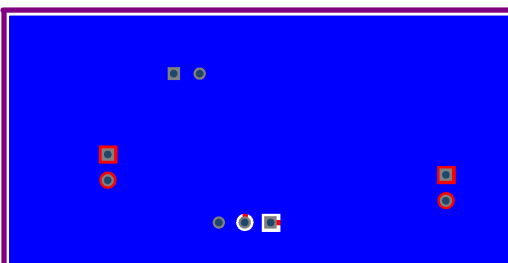

Bottom Layer

Typical Performance Characteristics
(L use wire wound chip power inductor)

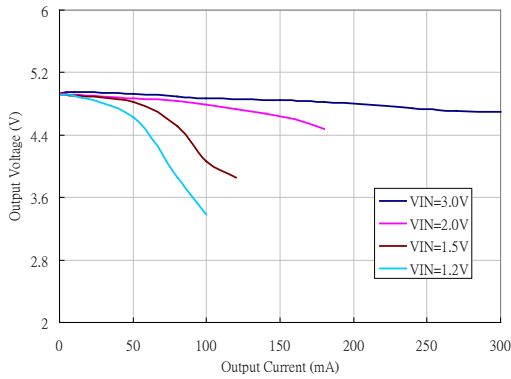

Fig 1. HT7750S Output Voltage vs. Output Current

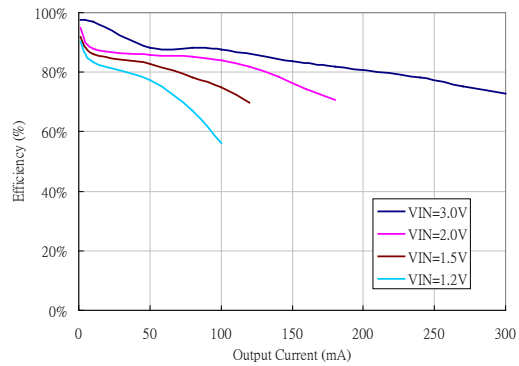

Fig 2. HT7750S Efficiency vs. Output Current

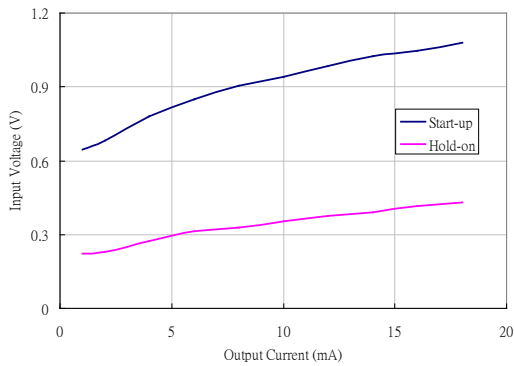

Fig 3. HT7750S Start-up & Hold-on Voltage

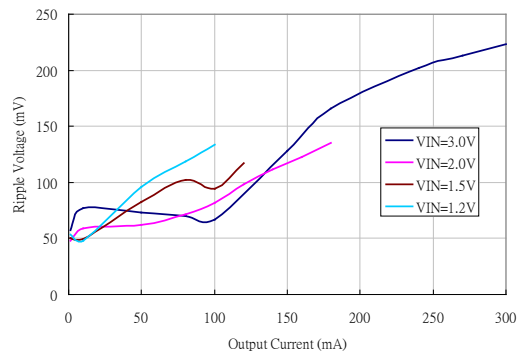

Fig 4. HT7750S Ripple Voltage vs. Output Current

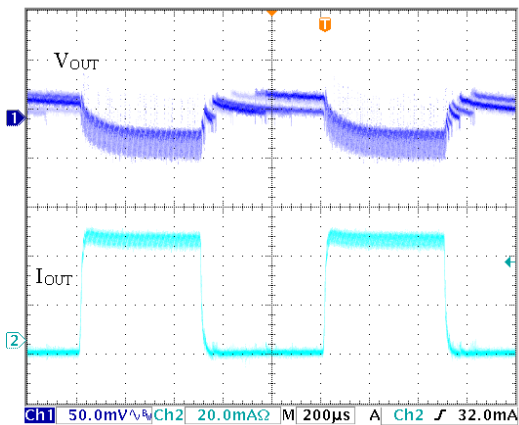

Fig 5. HT7750S Load Transient Response
(L= 10µH, CIN= COUT= 10µF, VIN= 3.0V)

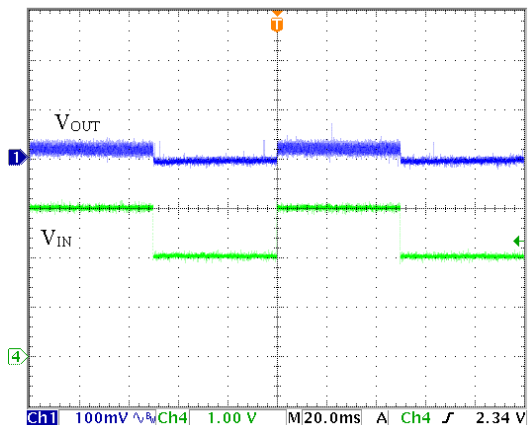

Fig 6. HT7750S Line Transient Response
(L= 10µH, CIN= COUT= 10µF, VIN= 3.0V)

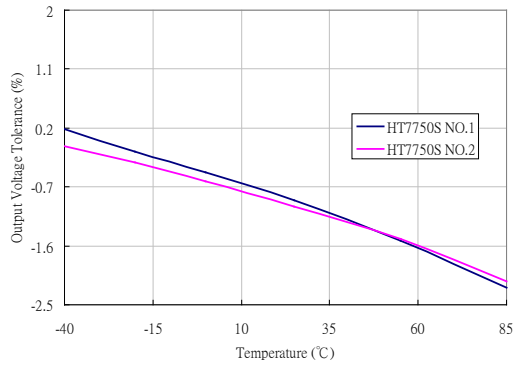

Fig 7. HT7750S Output Voltage Tolerance vs. Temperature

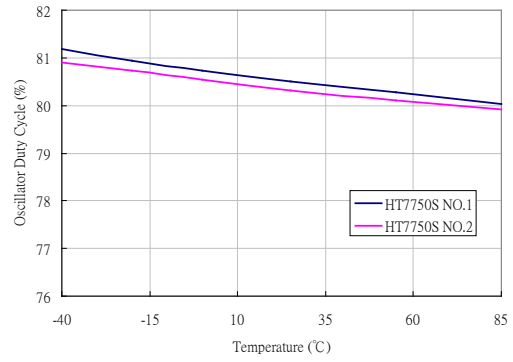

Fig 8. HT7750S Oscillator Duty Cycle vs. Temperature

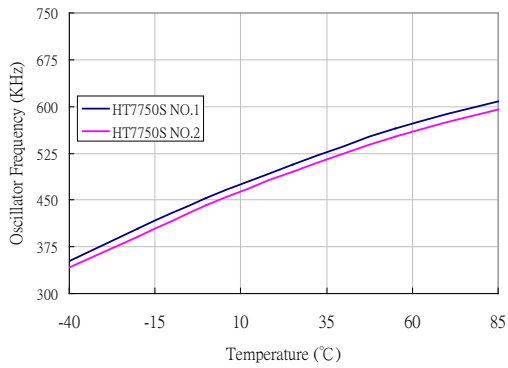

Fig 9. HT7750S Oscillator Frequency vs. Temperature

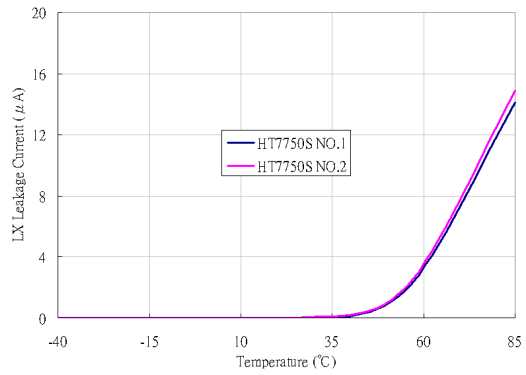

Fig 10. HT7750S LX Leakage Current vs. Temperature

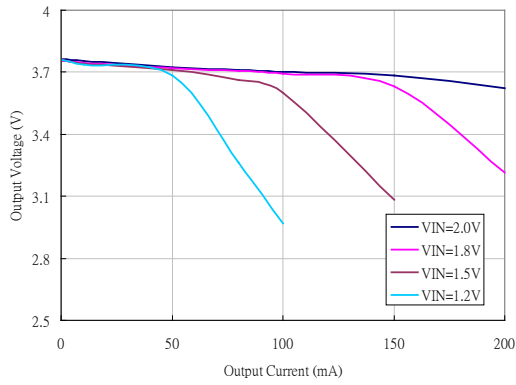

Fig 11. HT7737S Output Voltage vs. Output Current

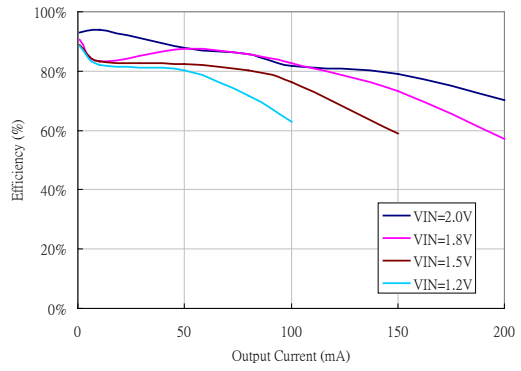

Fig 12. HT7737S Efficiency vs. Output Current

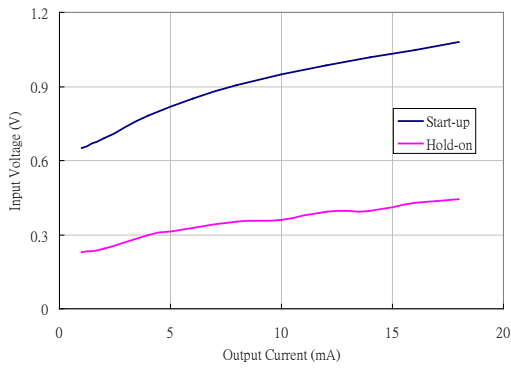

Fig 13. HT7737S Start-up & Hold-on Voltage

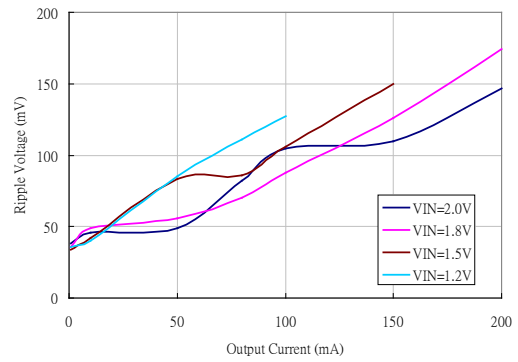

Fig 14. HT7737S Ripple Voltage vs. Output Current

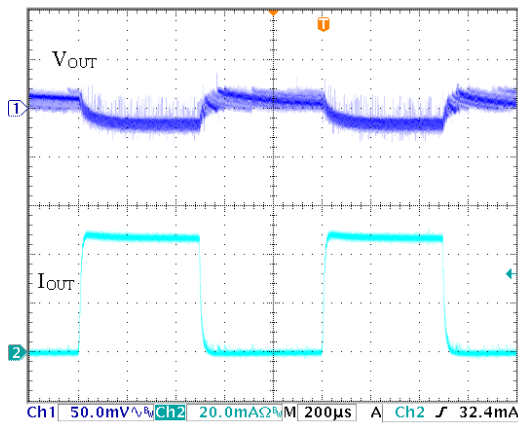

Fig 15. HT7737S Load Transient Response
($L = 10\mu\text{H}$, $C_{\text{IN}} = C_{\text{OUT}} = 10\mu\text{F}$, $V_{\text{IN}} = 2.22\text{V}$)

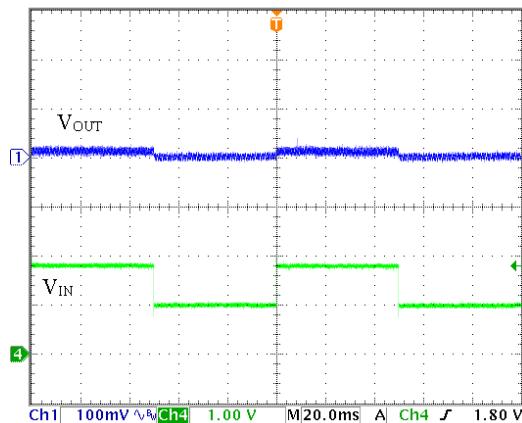

Fig 16. HT7737S Line Transient Response
($L = 10\mu\text{H}$, $C_{\text{IN}} = C_{\text{OUT}} = 10\mu\text{F}$, $V_{\text{IN}} = 2.22\text{V}$)

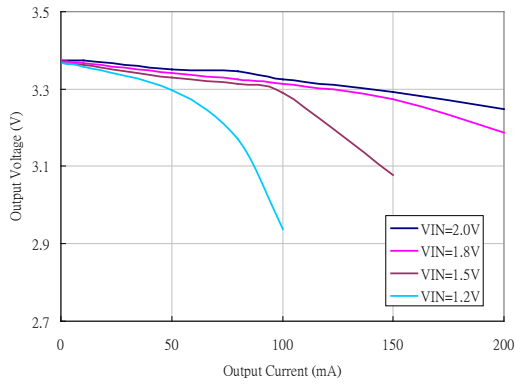

Fig 17. HT7733S Output Voltage vs. Output Current

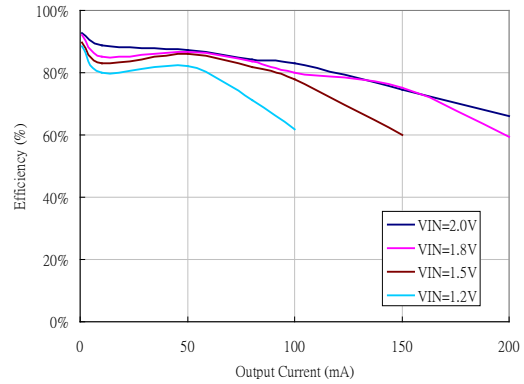

Fig 18. HT7733S Efficiency vs. Output Current

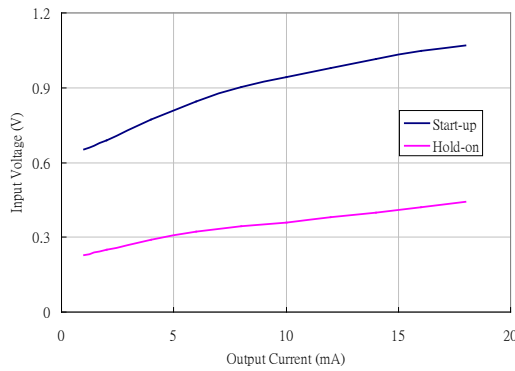

Fig 19. HT7733S Start-up & Hold-on Voltage

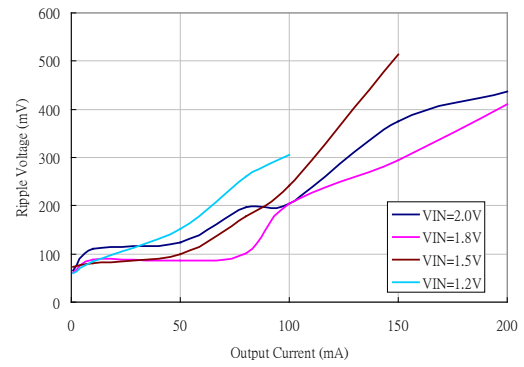

Fig 20. HT7733S Ripple Voltage vs. Output Current

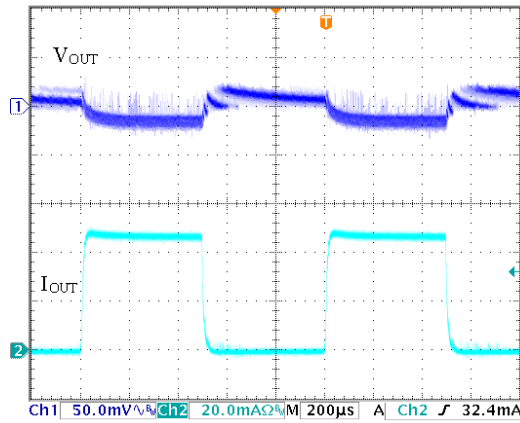

Fig 21. HT7733S Load Transient Response
($L=10\mu\text{H}$, $C_{\text{IN}}=C_{\text{OUT}}=10\mu\text{F}$, $V_{\text{IN}}=1.98\text{V}$)

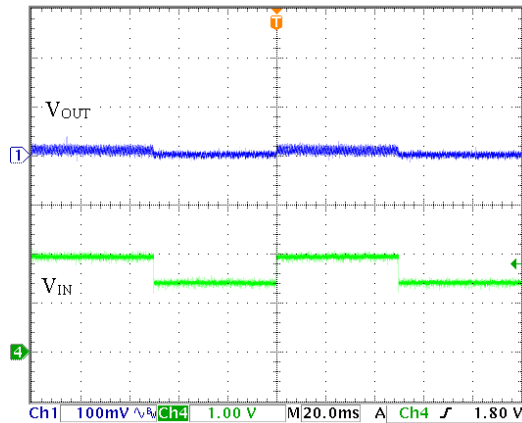

Fig 22. HT7733S Line Transient Response
($L=10\mu\text{H}$, $C_{\text{IN}}=C_{\text{OUT}}=10\mu\text{F}$, $V_{\text{IN}}=1.98\text{V}$)

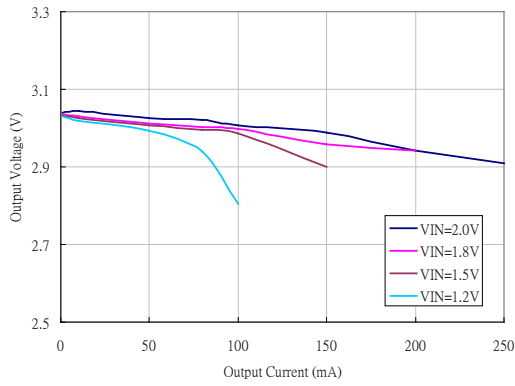

Fig 23. HT7730S Output Voltage vs. Output Current

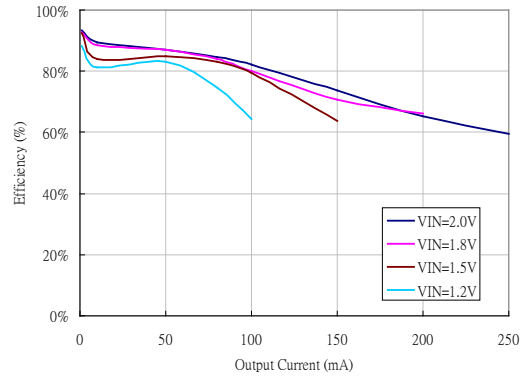

Fig 24. HT7730S Efficiency vs. Output Current

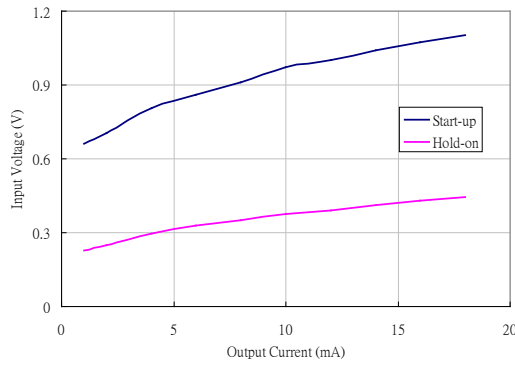

Fig 25. HT7730S Start-up & Hold-on Voltage

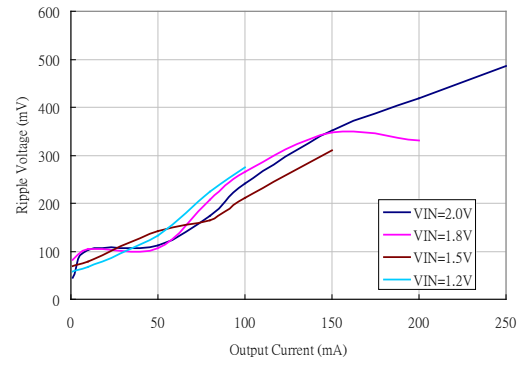

Fig 26. HT7730S Ripple Voltage vs. Output Current

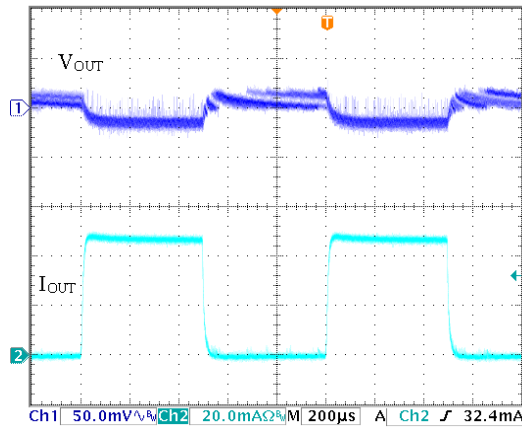

Fig 27. HT7730S Load Transient Response
(L=10μH, C_{IN}=C_{OUT}=10μF, V_{IN}=1.8V)

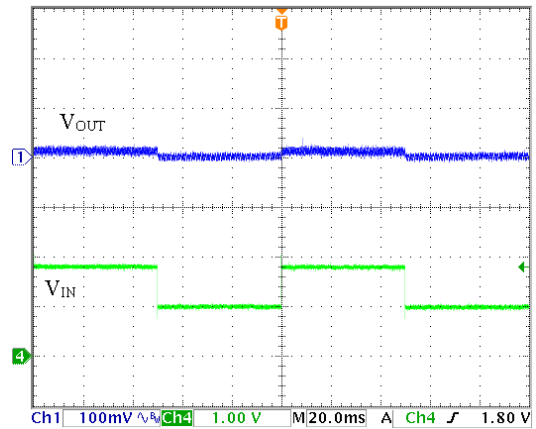

Fig 28. HT7730S Line Transient Response
(L=10μH, C_{IN}=C_{OUT}=10μF, V_{IN}=1.8V)

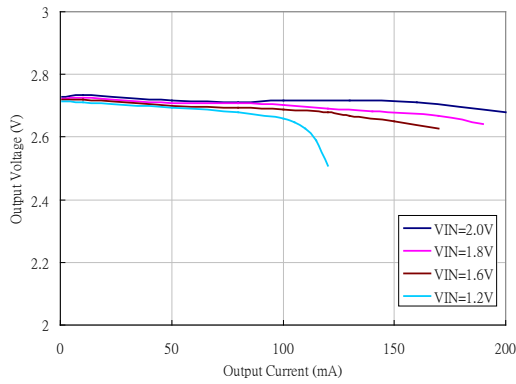

Fig 29. HT7727S Output Voltage vs. Output Current

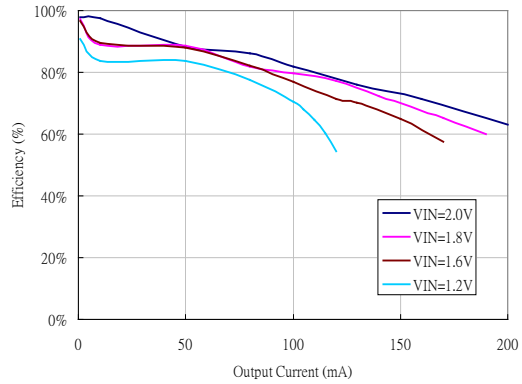

Fig 30. HT7727S Efficiency vs. Output Current

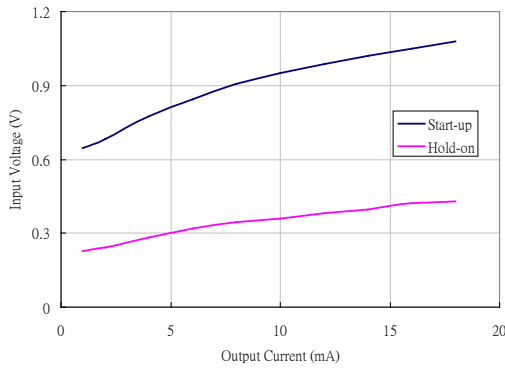

Fig 31. HT7727S Start-up & Hold-on Voltage

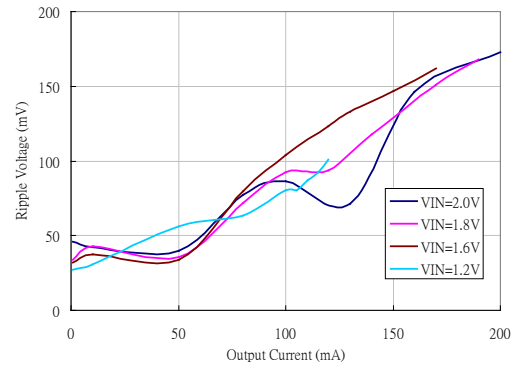

Fig 32. HT7727S Ripple Voltage vs. Output Current

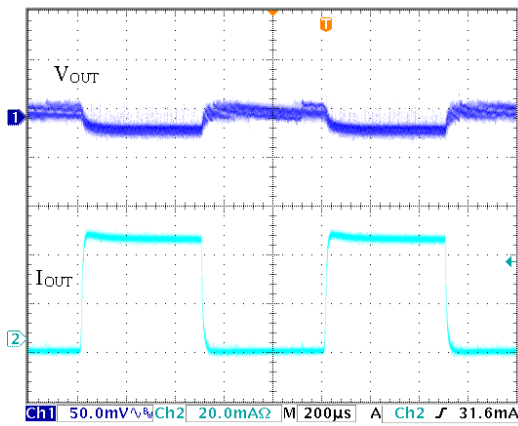

Fig 33. HT7727S Load Transient Response
($L = 10\mu\text{H}$, $C_{\text{IN}} = C_{\text{OUT}} = 10\mu\text{F}$, $V_{\text{IN}} = 1.62\text{V}$)

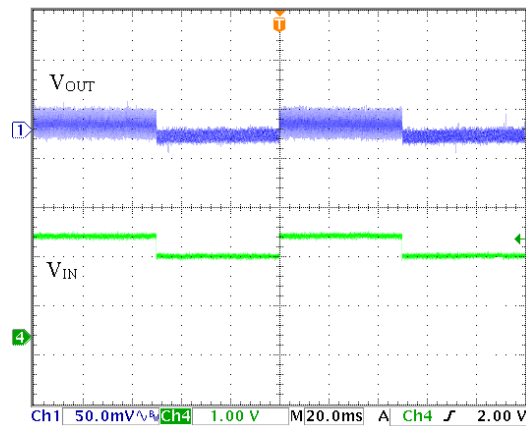

Fig 34. HT7727S Line Transient Response
($L = 10\mu\text{H}$, $C_{\text{IN}} = C_{\text{OUT}} = 10\mu\text{F}$, $V_{\text{IN}} = 1.62\text{V}$)

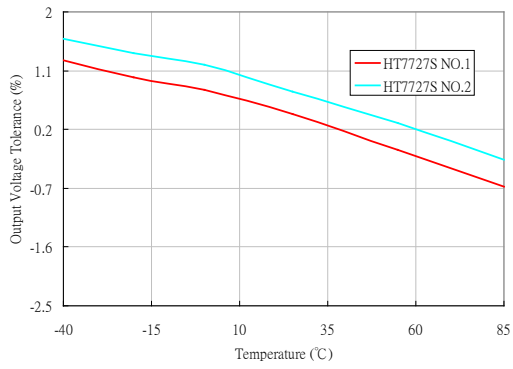

Fig 35. HT7727S Output Voltage Tolerance vs. Temperature

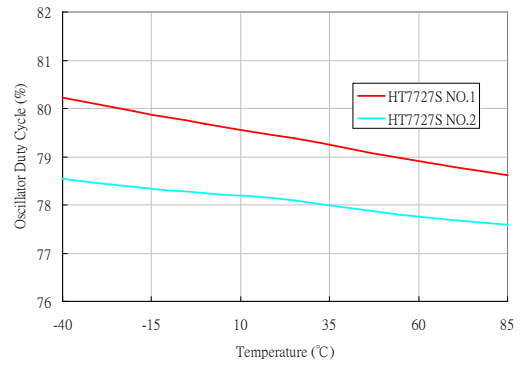

Fig 36. HT7727S Oscillator Duty Cycle vs. Temperature

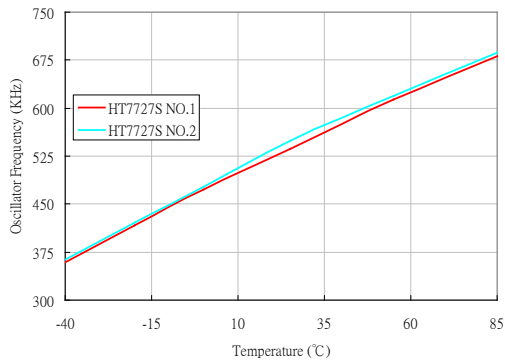

Fig 37. HT7727S Oscillator Frequency vs. Temperature

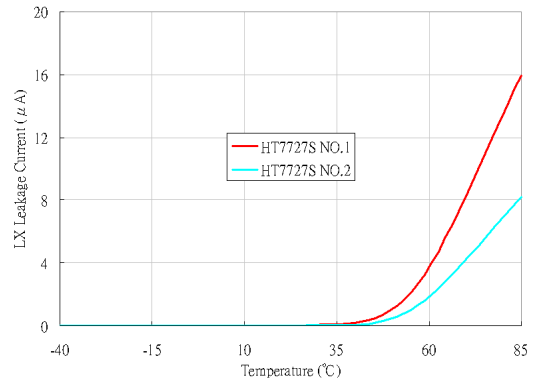

Fig 38. HT7727S LX Leakage Current vs. Temperature

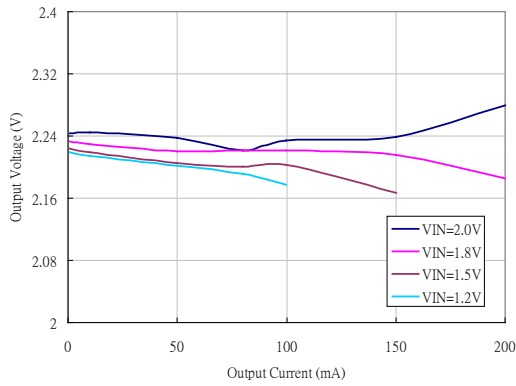

Fig 39. HT7722S Output Voltage vs. Output Current

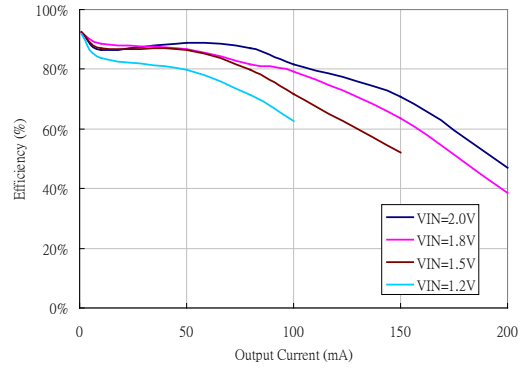

Fig 40. HT7722S Efficiency vs. Output Current

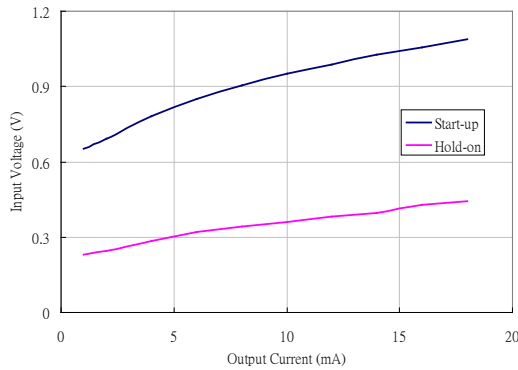

Fig 41. HT7722S Start-up & Hold-on Voltage

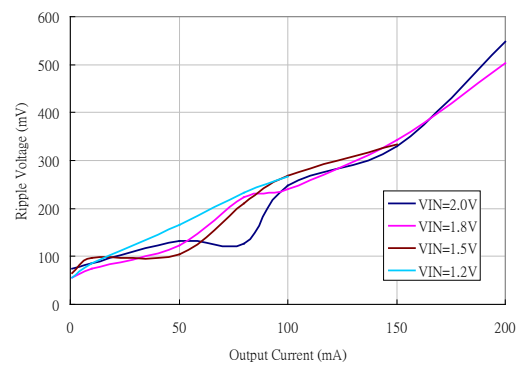

Fig 42. HT7722S Ripple Voltage vs. Output Current

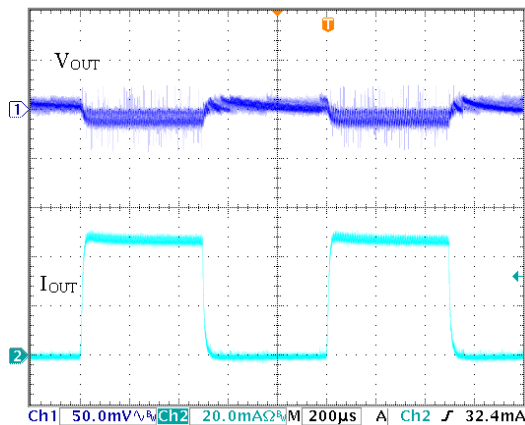

Fig 43. HT7722S Load Transient Response
(L= 10μH, C_{IN}= C_{OUT}= 10μF, V_{IN}= 1.32V)

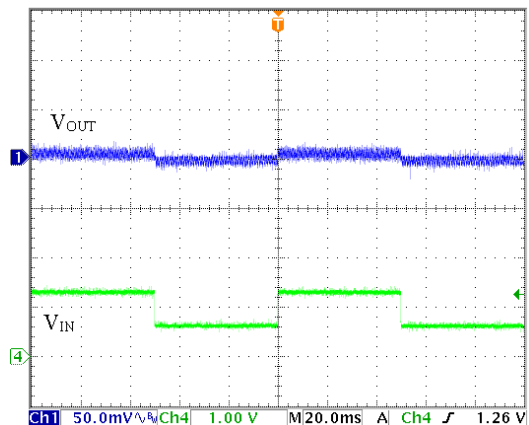

Fig 44. HT7722S Line Transient Response
(L= 10μH, C_{IN}= C_{OUT}= 10μF, V_{IN}= 1.32V)

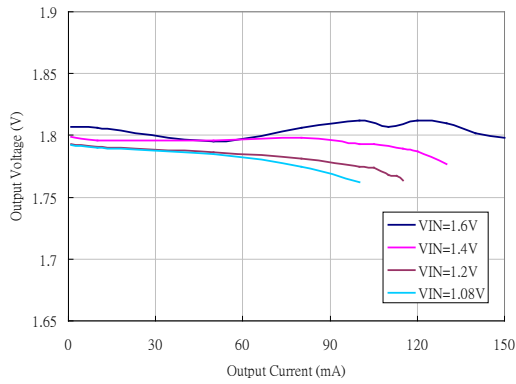

Fig 45. HT7718S Output Voltage vs. Output Current

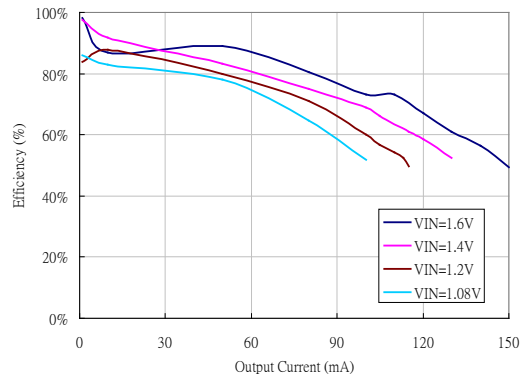

Fig 46. HT7718S Efficiency vs. Output Current

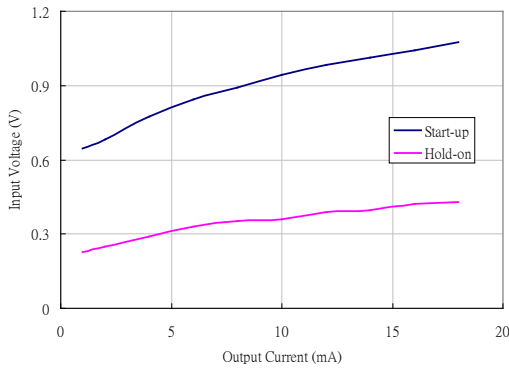

Fig 47. HT7718S Start-up & Hold-on Voltage

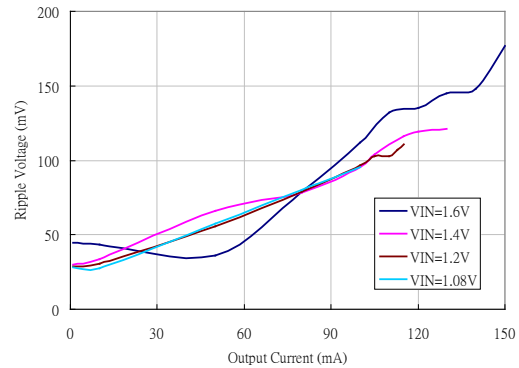

Fig 48. HT7718S Ripple Voltage vs. Output Current

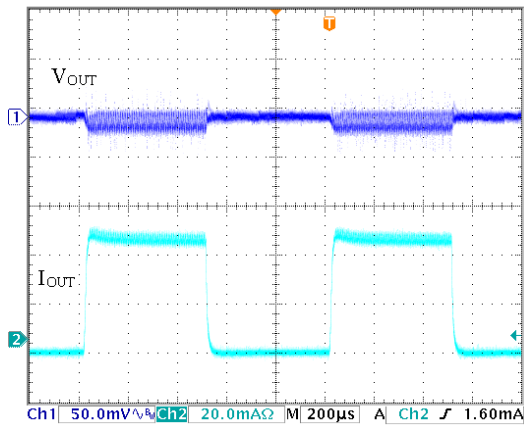

Fig 49. HT7718S Load Transient Response
($L = 10\mu\text{H}$, $C_{\text{IN}} = C_{\text{OUT}} = 10\mu\text{F}$, $V_{\text{IN}} = 1.08\text{V}$)

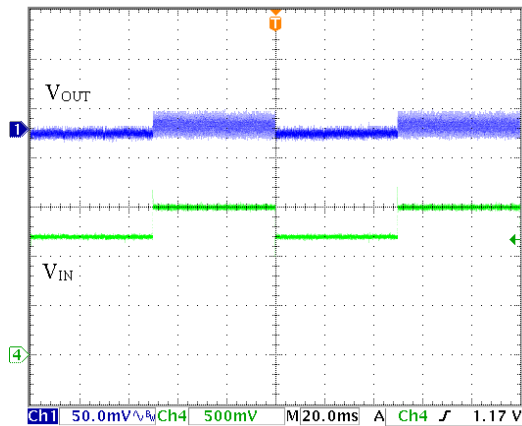

Fig 50. HT7718S Line Transient Response
($L = 10\mu\text{H}$, $C_{\text{IN}} = C_{\text{OUT}} = 10\mu\text{F}$, $V_{\text{IN}} = 1.08\text{V}$)

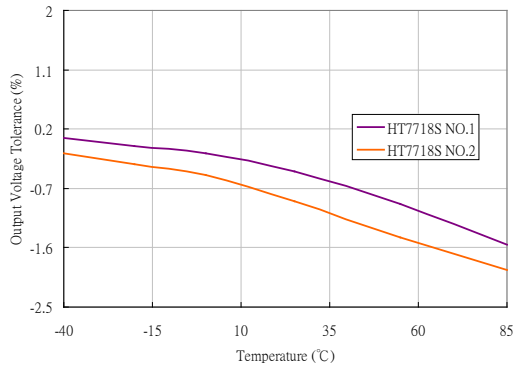

Fig 51. HT7718S Output Voltage Tolerance vs. Temperature

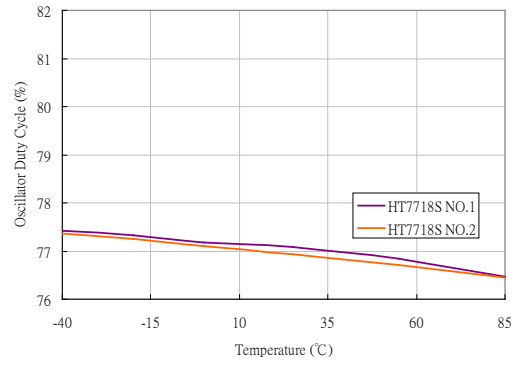

Fig 52. HT7718S Oscillator Duty Cycle vs. Temperature

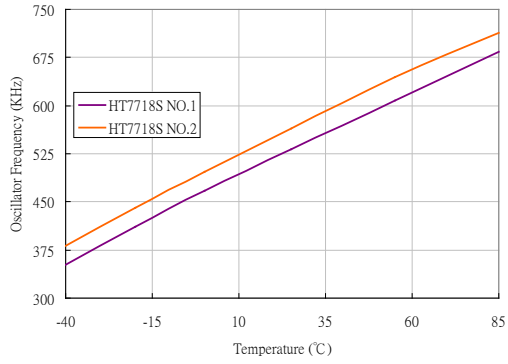

Fig 53. HT7718S Oscillator Frequency vs. Temperature

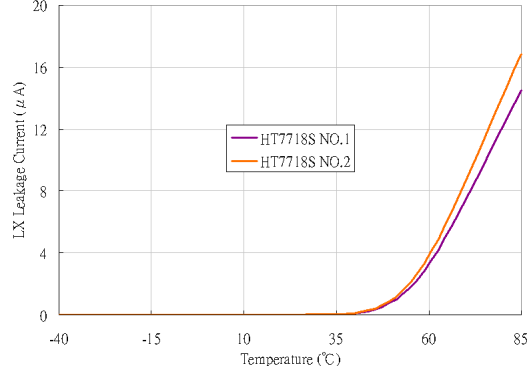

Fig 54. HT7718S LX Leakage Current vs. Temperature

**Typical Performance Characteristics
(L use multi-layered chip power inductor)**

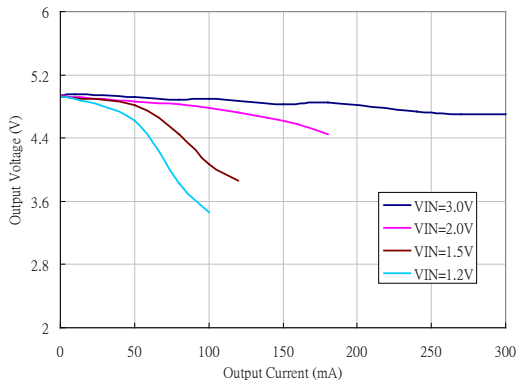

Fig 55. HT7750S Output Voltage vs. Output Current

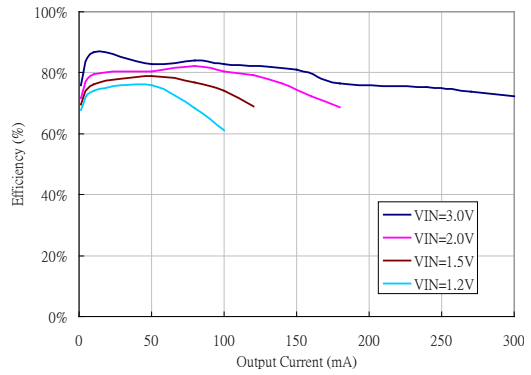

Fig 56. HT7750S Efficiency vs. Output Current

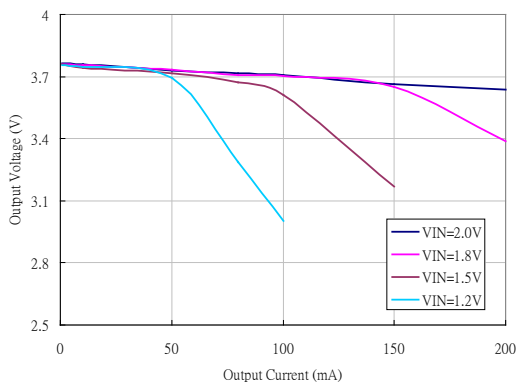

Fig 57. HT7737S Output Voltage vs. Output Current

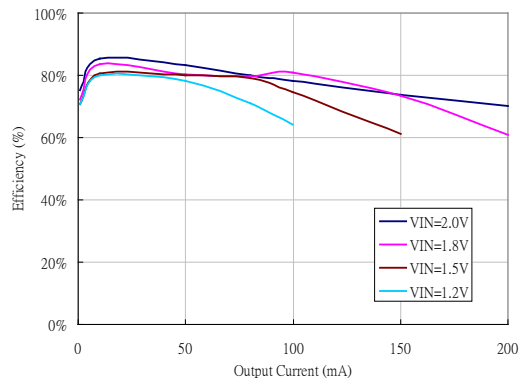

Fig 58. HT7737S Efficiency vs. Output Current

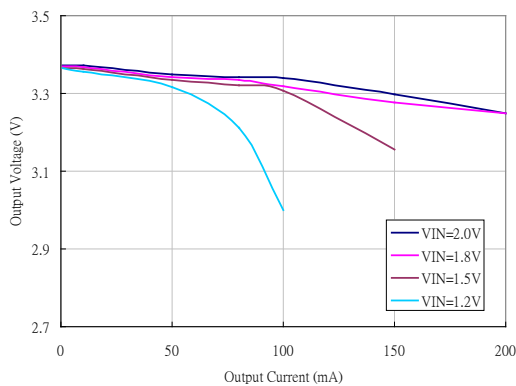

Fig 59. HT7733S Output Voltage vs. Output Current

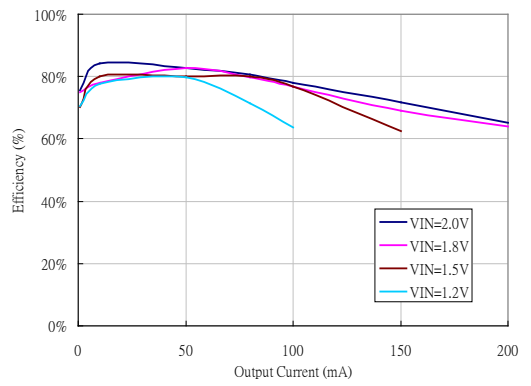

Fig 60. HT7733S Efficiency vs. Output Current

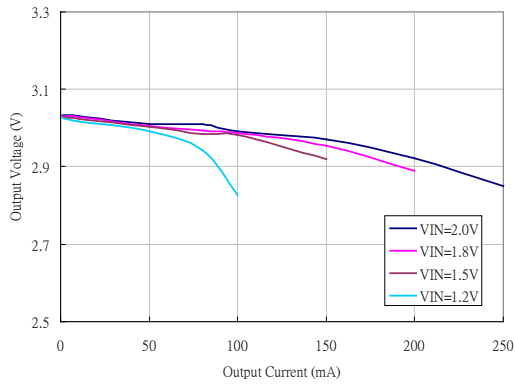

Fig 61. HT7730S Output Voltage vs. Output Current

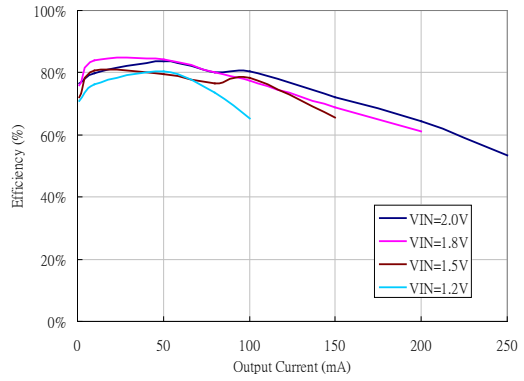

Fig 62. HT7730S Efficiency vs. Output Current

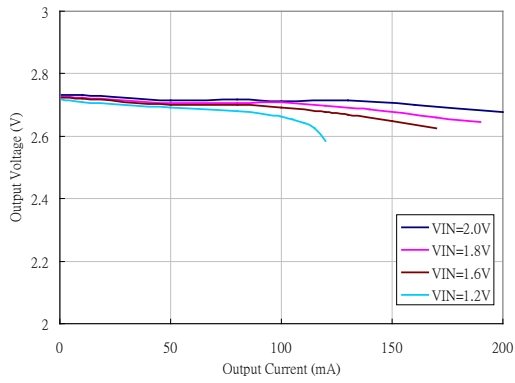

Fig 63. HT7727S Output Voltage vs. Output Current

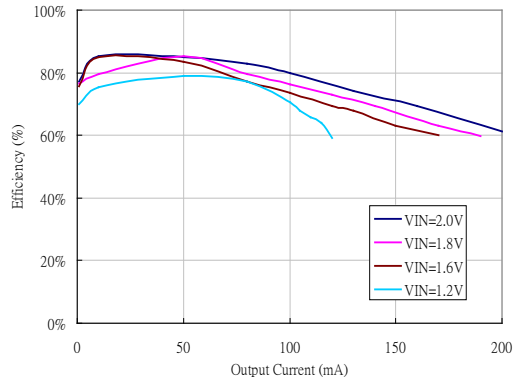

Fig 64. HT7727S Efficiency vs. Output Current

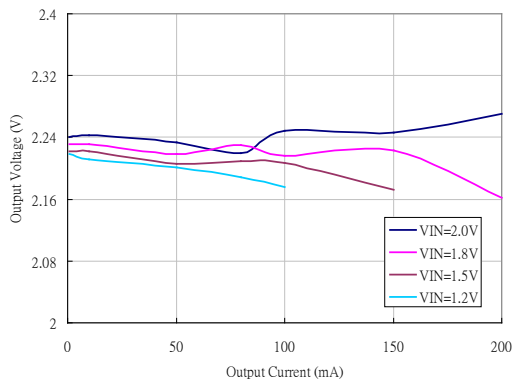

Fig 65. HT7722S Output Voltage vs. Output Current

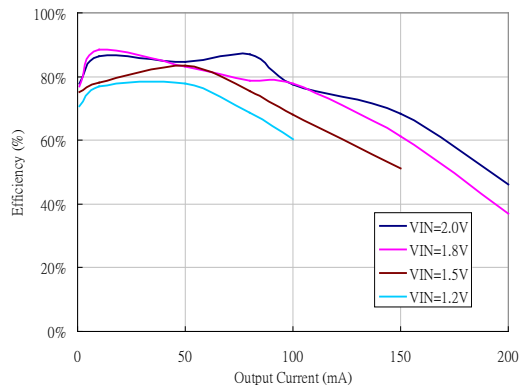

Fig 66. HT7722S Efficiency vs. Output Current

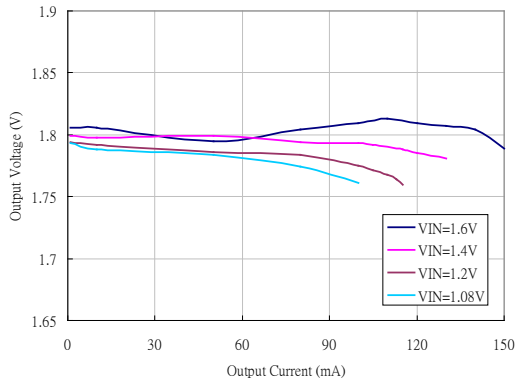

Fig 67. HT7718S Output Voltage vs. Output Current

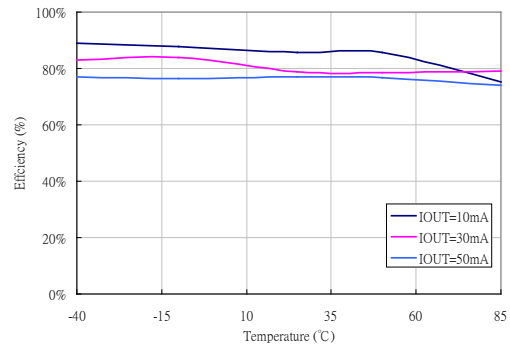

Fig 69. HT7718S Temperature vs. Output Voltage

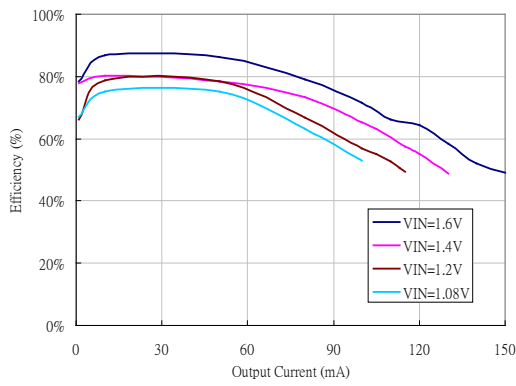

Fig 68. HT7718S Efficiency vs. Output Current

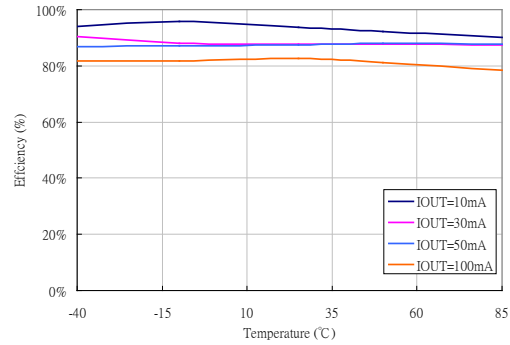

Fig 70. HT7733S Temperature vs. Output Voltage

Package Information

Note that the package information provided here is for consultation purposes only. As this information may be updated at regular intervals users are reminded to consult the [Holtek website](#) for the latest version of the [Package/ Carton Information](#).

Additional supplementary information with regard to packaging is listed below. Click on the relevant section to be transferred to the relevant website page.

- Package Information (include Outline Dimensions, Product Tape and Reel Specifications)
- The Operation Instruction of Packing Materials
- Carton information

3-pin SOT89 Outline Dimensions

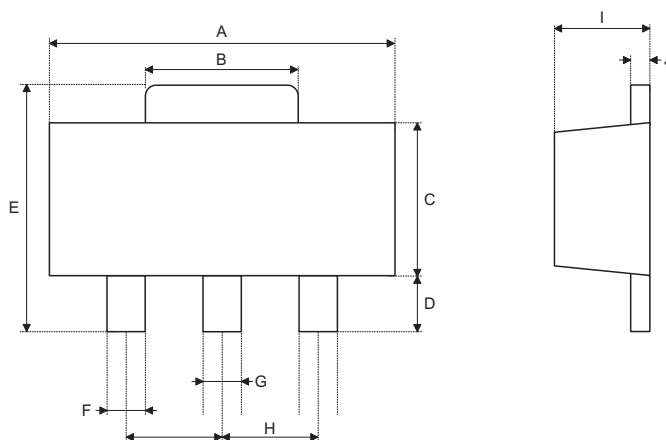

Symbol	Dimensions in inch		
	Min.	Nom.	Max.
A	0.173	—	0.185
B	0.053	—	0.072
C	0.090	—	0.106
D	0.031	—	0.047
E	0.155	—	0.173
F	0.014	—	0.019
G	0.017	—	0.022
H	—	0.059 BSC	—
I	0.055	—	0.063
J	0.014	—	0.017

Symbol	Dimensions in mm		
	Min.	Nom.	Max.
A	4.40	—	4.70
B	1.35	—	1.83
C	2.29	—	2.70
D	0.80	—	1.20
E	3.94	—	4.40
F	0.36	—	0.48
G	0.44	—	0.56
H	—	1.50 BSC	—
I	1.40	—	1.60
J	0.35	—	0.44

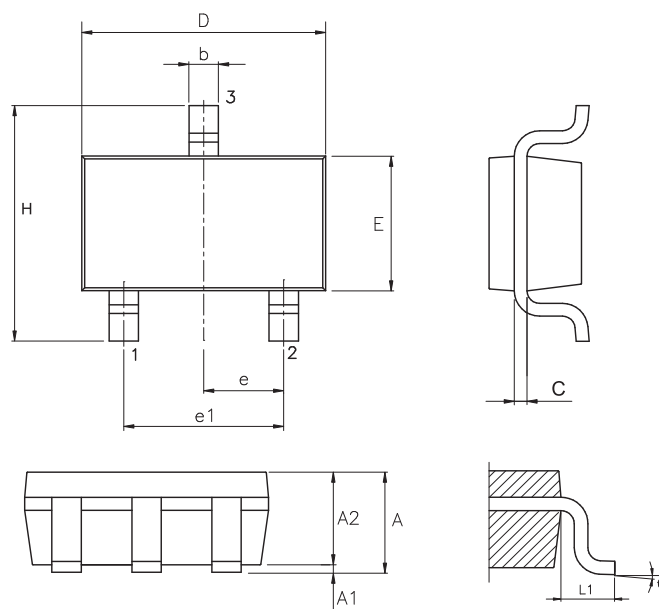
3-pin SOT23 Outline Dimensions

Symbol	Dimensions in inch		
	Min.	Nom.	Max.
A	—	—	0.057
A1	—	—	0.006
A2	0.035	0.045	0.051
b	0.012	—	0.020
C	0.003	—	0.009
D	—	0.114 BSC	—
E	—	0.063 BSC	—
e	—	0.037 BSC	—
e1	—	0.075 BSC	—
H	—	0.110 BSC	—
L1	—	0.024 BSC	—
θ	0°	—	8°

Symbol	Dimensions in mm		
	Min.	Nom.	Max.
A	—	—	1.45
A1	—	—	0.15
A2	0.90	1.15	1.30
b	0.30	—	0.50
C	0.08	—	0.22
D	—	2.90 BSC	—
E	—	1.60 BSC	—
e	—	0.95 BSC	—
e1	—	1.90 BSC	—
H	—	2.80 BSC	—
L1	—	0.60 BSC	—
θ	0°	—	8°

5-pin SOT23 Outline Dimensions

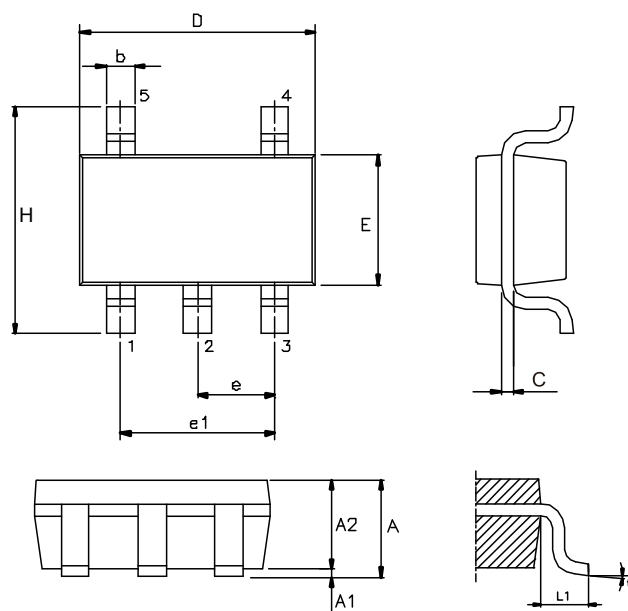

Symbol	Dimensions in inch		
	Min.	Nom.	Max.
A	—	—	0.057
A1	—	—	0.006
A2	0.035	0.045	0.051
b	0.012	—	0.020
C	0.003	—	0.009
D	—	0.114 BSC	—
E	—	0.063 BSC	—
e	—	0.037 BSC	—
e1	—	0.075 BSC	—
H	—	0.110 BSC	—
L1	—	0.024 BSC	—
θ	0°	—	8°

Symbol	Dimensions in mm		
	Min.	Nom.	Max.
A	—	—	1.45
A1	—	—	0.15
A2	0.90	1.15	1.30
b	0.30	—	0.50
C	0.08	—	0.22
D	—	2.90 BSC	—
E	—	1.60 BSC	—
e	—	0.95 BSC	—
e1	—	1.90 BSC	—
H	—	2.80 BSC	—
L1	—	0.60 BSC	—
θ	0°	—	8°

Copyright© 2018 by HOLTEK SEMICONDUCTOR INC.

The information appearing in this Data Sheet is believed to be accurate at the time of publication. However, Holtek assumes no responsibility arising from the use of the specifications described. The applications mentioned herein are used solely for the purpose of illustration and Holtek makes no warranty or representation that such applications will be suitable without further modification, nor recommends the use of its products for application that may present a risk to human life due to malfunction or otherwise. Holtek's products are not authorized for use as critical components in life support devices or systems. Holtek reserves the right to alter its products without prior notification. For the most up-to-date information, please visit our web site at <http://www.holtek.com>.