

GBU6005 THRU GBU610

Glass Passivated Single-phase Bridge Rectifiers

Reverse Voltage - 50 to 1000 V

Forward Current - 6 A

Features

- Plastic material has Underwriters Laboratory Flammability Classification 94V-0
- Ideal for printed circuit boards
- Glass passivated chip junction
- Reliable low cost construction utilizing molded plastic technique

Mechanical Data

- **Case:** Molded plastic, GBU
- **Terminals:** leads solderable per MIL-STD-202 Method 208 guaranteed
- **Mounting Position:** Any

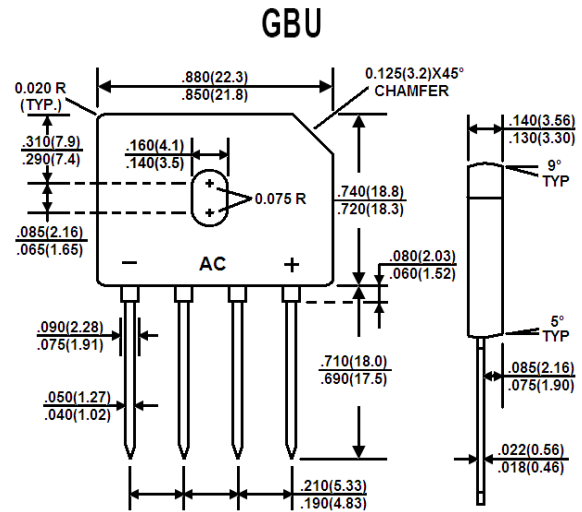

Dimensions in millimeters

Maximum Ratings and Electrical Characteristics

Ratings at 25 °C ambient temperature unless otherwise specified. Single phase, half wave, resistive or inductive load, for capacitive load, derate by 20%

Parameter	Symbols	GBU6005	GBU601	GBU602	GBU604	GBU606	GBU608	GBU610	Unit
Maximum Recurrent Peak Reverse Voltage	V_{RRM}	50	100	200	400	600	800	1000	V
Maximum RMS Voltage	V_{RMS}	35	70	140	280	420	560	700	V
Maximum DC Blocking Voltage	V_{DC}	50	100	200	400	600	800	1000	V
Maximum Average Forward Rectified Current at $T_C = 100^\circ C$ ^{1), 2)}	$I_{F(AV)}$	6							A
Peak Forward Surge Current, 8.3 ms Single Half Sine-wave Superimposed on Rated Load (JEDEC Method)	I_{FSM}	175							A
Maximum Forward Voltage at 3 A	V_F	1							V
Maximum Reverse Current at $T_A = 25^\circ C$ at Rated DC Blocking Voltage $T_A = 125^\circ C$	I_R	5 500							μA
Typical Junction Capacitance ³⁾	C_J	210				94			pF
Typical Thermal Resistance ^{1), 2)}	$R_{\theta JA}$	7.4							$^\circ C/W$
Typical Thermal Resistance ^{1), 2)}	$R_{\theta JC}$	2.2							$^\circ C/W$
Operating and Storage Temperature Range	T_j, T_{stg}	- 55 to + 150							$^\circ C$

¹⁾ Units case mounted on 2.6 X 1.4 X 0.06" thick (6.5 X 3.5 X 0.15 cm) Al. plate heatsink..

²⁾ Recommended mounting position is to bolt down on heatsink with silicone thermal compound for maximum heat transfer with #6 screws.

³⁾ Measured at 1 MHz and applied reverse voltage of 4.0 VDC.

TOP DYNAMIC



ISO14001 : 2004 Certificate No. 121505007
 ISO 9001 : 2008 Certificate No. 50114012
 OHSAS 18001 : 2007 Certificate No. 05131500006
 IECQ QC 080000 Certificate No. ECU41000741002

Dated :26/08/2016 H Rev:02

GBU6005 THRU GBU610

**Fig. 1 – Derating Curve
Output Rectified Current**

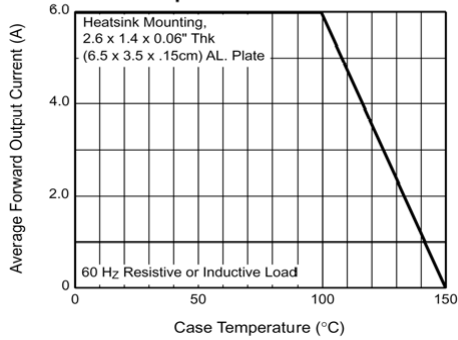

**Fig. 2 – Maximum Non-Repetitive Peak
Forward Surge Current Per Leg**

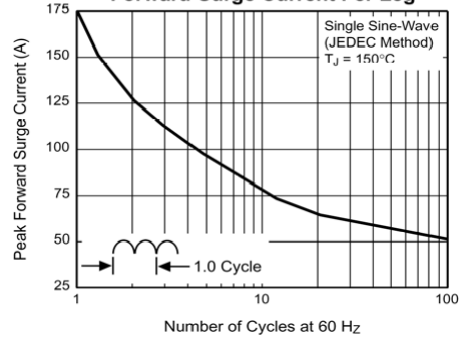

**Fig. 3 – Typical Forward
Characteristics Per Leg**

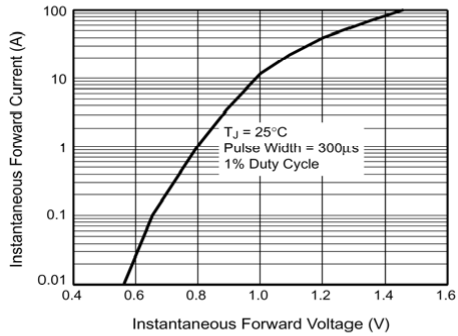

**Fig. 4 – Typical Reverse Leakage
Characteristics Per Leg**

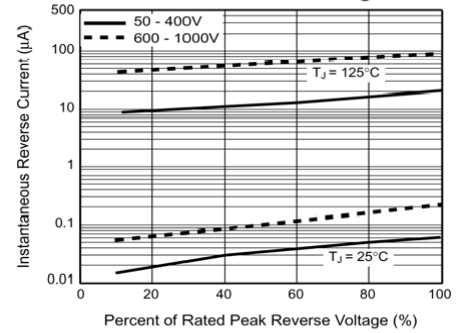

**Fig. 5 – Typical Junction
Capacitance Per Leg**

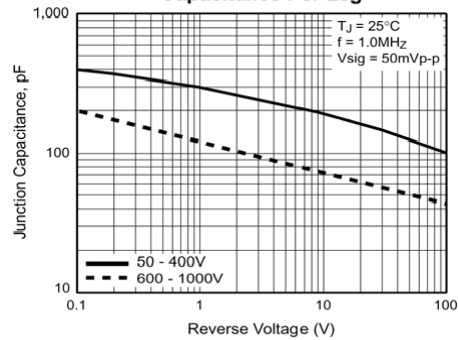

**Fig. 6 – Typical Transient
Thermal Impedance**

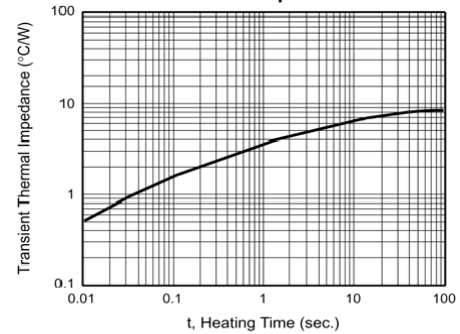

TOP DYNAMIC

