

高精度表面贴装 VC-TCXO/TCXO

DSA1612SDN/DSA211SDN/DSA221SDN/DSA321SDN
DSB1612SDN/DSB211SDN/DSB221SDN/DSB321SDN/DSB1612SDNB/DSB211SDNB/DSB221SDNB/DSB321SDNB

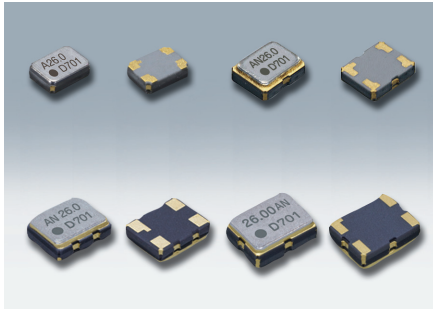

实际尺寸 DSA1612SDN □ DSA211SDN □
DSA221SDN □ DSA321SDN □

■ 优点

- 支持低电压
 - 低相位噪音
 - 单体结构
 - 无需防湿包装管理
- Moisture Sensitivity Level : LEVEL 1
(IPC/JEDEC J-STD-033)

■ 用途

- 手机、GPS/GNSS、工业用无线通信设备等

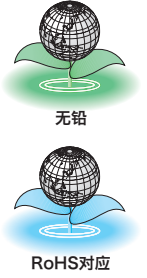

[型号]

VC-TCXO	TCXO	带Stand-by功能TCXO	尺寸
DSA1612SDN	DSB1612SDN	DSB1612SDNB	1612尺寸
DSA211SDN	DSB211SDN	DSB211SDNB	2016尺寸
DSA221SDN	DSB221SDN	DSB221SDNB	2520尺寸
DSA321SDN	DSB321SDN	DSB321SDNB	3225尺寸

■ 一般规格

项目	VC-TCXO				TCXO							
	DSA1612SDN	DSA211SDN	DSA221SDN	DSA321SDN	DSB1612SDN	DSB211SDN	DSB221SDN	DSB321SDN	DSB1612SDNB (带Stand-by功能)	DSB211SDNB (带Stand-by功能)	DSB221SDNB (带Stand-by功能)	DSB321SDNB (带Stand-by功能)
输出频率范围	16~60MHz	12.288~52MHz	9.6~52MHz		16~60MHz	12.288~52MHz	9.6~52MHz		16~60MHz	12.288~52MHz	9.6~52MHz	
标准频率	19.2MHz/26MHz/38.4MHz/40MHz/52MHz				16.3676MHz/16.367667MHz/16.368MHz/16.369MHz/16.8MHz/26MHz/33.6MHz							
电源电压范围	+1.68~+3.5V											
电源电压(Vcc)	+1.8V/+2.6V/+2.8V/+3.0V/+3.3V											
消耗电流	+1.5mA max. (f≤26MHz)/+2.0mA max. (26<f≤52MHz)/+2.5mA max. (f≤60MHz)											
待机时电流	-								+3μA max.			
输出电压	0.8Vp-p min. (f≤52MHz) (削峰正弦波/DC-coupled)											
输出负载	10kΩ//10pF											
频率稳定度 常温偏差	±1.5×10 ⁻⁶ max. (After 2 reflows)											
温度特性	±1.0×10 ⁻⁶ , ±2.5×10 ⁻⁶ max./-30~+85°C ±1.0×10 ⁻⁶ , ±2.5×10 ⁻⁶ max./-40~+85°C (Option)				±0.5×10 ⁻⁶ , ±2.5×10 ⁻⁶ max./-30~+85°C ±0.5×10 ⁻⁶ , ±2.5×10 ⁻⁶ max./-40~+85°C (Option)							
电源电压特性	±0.2×10 ⁻⁶ max. (Vcc ±5%)											
负载变化特性	±0.2×10 ⁻⁶ max. (10kΩ//10pF±10%)											
长期变化	±1.0×10 ⁻⁶ max./year											
频率控制 控制灵敏度	±3.0×10 ⁻⁶ ~±5.0×10 ⁻⁶ /Vcont=+1.4V±1V @Vcc≥+2.6V ±3.0×10 ⁻⁶ ~±5.0×10 ⁻⁶ /Vcont=+0.9V±0.6V @Vcc=+1.8V				-							
频率控制极性	正极性				-							
启动时间	2.0ms max.											
输出使能时间	-								2.0ms max.			
相位噪音	[f≤26MHz]				[26MHz<f≤40MHz]				[40MHz<f≤52MHz]			
Offset 100Hz	-115dBc/Hz				-110dBc/Hz				-105dBc/Hz			
Offset 1kHz	-130dBc/Hz				-130dBc/Hz				-125dBc/Hz			
Offset 10kHz	-150dBc/Hz				-150dBc/Hz				-145dBc/Hz			
Offset 100kHz	-155dBc/Hz				-155dBc/Hz				-150dBc/Hz			
包装单位	2000pcs./reel (φ 180)											

有关其他规格或者特殊规格请咨询营业部门。

高精度表面贴装 VC-TCXO/TCXO

For Mobile communications/Industrial system/GPS/GNSS

外形尺寸

[mm]

■ DSA1612SDN/DSB1612SDN/DSB1612SDNB

型号代码

A: VC-TCXO (DSA1612SDN)
B: TCXO (DSB1612SDN)
C: TCXO (DSB1612SDNB 带Stand-by功能)

Pin Connections

Pin No.	Connection
#1	Vcont(VC-TCXO)/GND(TCXO) ENABLE/DISABLE (Stand-by Function)
#2	GND
#3	Output
#4	Vcc

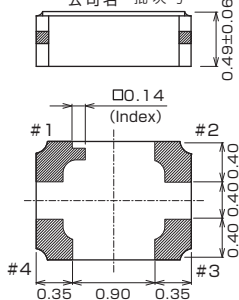
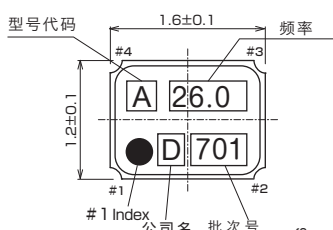

■ 焊盘图形 (参考)
<Top View>

■ DSA211SDN/DSB211SDN/DSB211SDNB

型号代码

AN: VC-TCXO (DSA211SDN)
BN: TCXO (DSB211SDN)
CN: TCXO (DSB211SDNB 带Stand-by功能)

Pin Connections

Pin No.	Connection
#1	Vcont(VC-TCXO)/GND(TCXO) ENABLE/DISABLE (Stand-by Function)
#2	GND
#3	Output
#4	Vcc

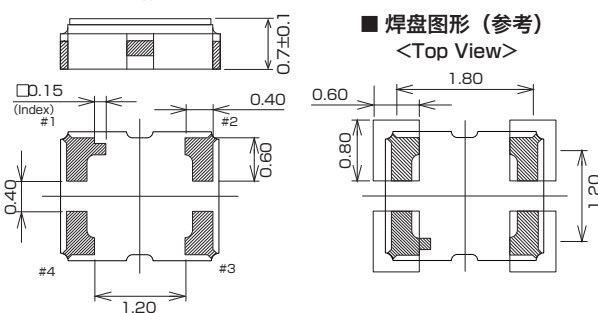
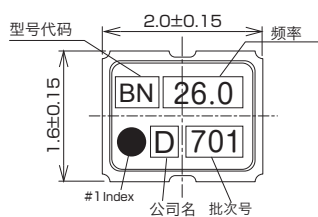

■ 焊盘图形 (参考)
<Top View>

■ DSA221SDN/DSB221SDN/DSB221SDNB

型号代码

AN: VC-TCXO (DSA221SDN)
BN: TCXO (DSB221SDN)
CN: TCXO (DSB221SDNB 带Stand-by功能)

Pin Connections

Pin No.	Connection
#1	Vcont(VC-TCXO)/GND(TCXO) ENABLE/DISABLE (Stand-by Function)
#2	GND
#3	Output
#4	Vcc

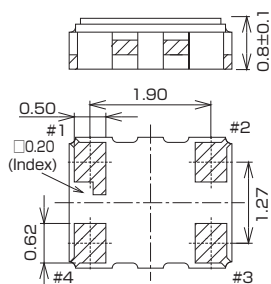
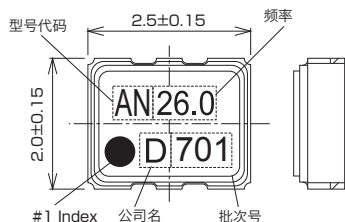

■ 焊盘图形 (参考)
<Top View>

■ DSA321SDN/DSB321SDN/DSB321SDNB

型号代码

AN: VC-TCXO (DSA321SDN)
BN: TCXO (DSB321SDN)
CN: TCXO (DSB321SDNB 带Stand-by功能)

Pin Connections

Pin No.	Connection
#1	Vcont(VC-TCXO)/GND(TCXO) ENABLE/DISABLE (Stand-by Function)
#2	GND
#3	Output
#4	Vcc

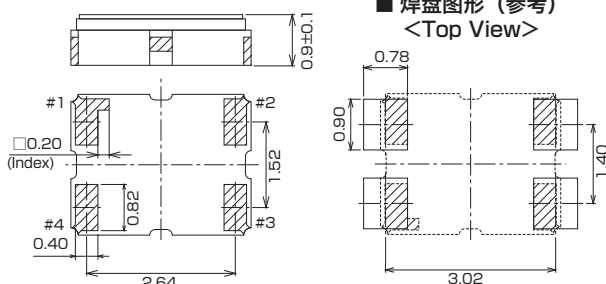
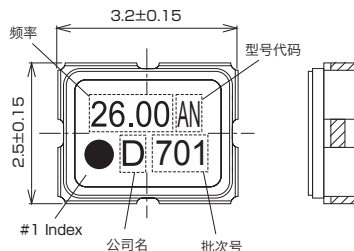

■ 焊盘图形 (参考)
<Top View>