

# Crystal Oscillator

## NT2520SC

CMOS output Temperature Compensated Crystal Oscillator(TCXO)  
with E/D function

### Main Application

Wireless module for Smart Meter, Bluetooth module for Automotive

### Features

- Output level : CMOS
- Supports low power supply voltage. (Supports DC +1.7 V to +3.3 V.)
- Compact and light with a height, cubic volume, and weight of Max. 0.9 mm, 0.004 cm<sup>3</sup>, and 0.014 g, respectively.
- A surface-mount crystal oscillator. (Reflow soldering is possible.)
- Lead-free. Meets the requirements for re-flow profiling using lead-free solder.



Pb Free

RoHS Compliant  
Directive 2011/65/EU

### Specifications

Item	Model	NT2520SC	
Nominal Frequency (MHz)		10 to 52	
Supply Voltage [V <sub>CC</sub> ] (V)		+1.8	+3.3
Load Impedance (pF)		15	
Current Consumption	Enable (mA)	Max. 10 (26MHz)	
	Disable (μA)	Max. 10 (V <sub>CC</sub> = +3.3V)	
V <sub>OL</sub> Max. / V <sub>OH</sub> Min. (V)		0.2 V <sub>CC</sub> / 0.8 V <sub>CC</sub>	
Tr Max. / Tf Max. (ns)		5/5 ( at 0.2 to 0.8V <sub>CC</sub> )	
Symmetry Min. to Max. (%)		45 to 55 ( at 1/2V <sub>CC</sub> )	
Frequency/Temperature Characteristics		Max. ±2.5×10 <sup>-6</sup>	
Operating Temperature Range (°C)		-30 to +85	
Storage Temperature Range (°C)		-40 to +85	
Long-term Frequency Stability		Max. ±1.0×10 <sup>-6</sup> /year	
Specification Number		NSA3642B	NSA3643B

\* Frequency setting conditions : Frequencies are set at normal temperatures (+25±2 °C).

### Dimensions

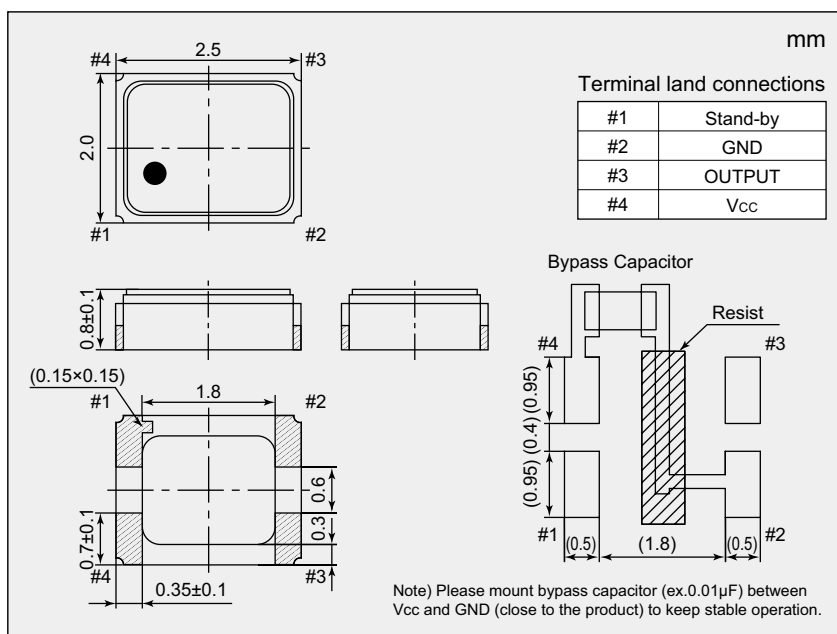

Please specify the model name, frequency, and specification number when you order products.  
For further questions regarding specifications, please feel free to contact us.