

# SiT8102

## 1 to 200 MHz High Performance Oscillator



### Features

- High frequency stability
  - $\pm 10$  PPM,  $\pm 15$  PPM,  $\pm 20$  PPM
  - $\pm 25$  PPM,  $\pm 50$  PPM,  $\pm 100$  PPM
- Extremely low RMS phase jitter (random)
  - 0.5 ps (typical)
- Wide frequency range
  - 1 to 200 MHz
- Operating voltage
  - 1.8, 2.5, 2.8V or 3.3 V
  - Other voltages up to 3.63 V (contact SiTime)
- Operating temperature range
  - Industrial,  $-40$  to  $85$  °C
  - Extended Commercial,  $-20$  to  $70$  °C
  - Commercial,  $0$  to  $70$  °C
- Small footprint
  - $2.5 \times 2.0 \times 0.75$  mm
  - $3.2 \times 2.5 \times 0.75$  mm
  - $5.0 \times 3.2 \times 0.75$  mm
  - $7.0 \times 5.0 \times 0.90$  mm
- All packages are Pb-free and ROHs compliant
- High drive option: 30pF load (contact factory)

### Benefits

- No crystal or load capacitors required
- Eliminates crystal qualification time
- Ultra-reliable start up and greater immunity from interference
- Replaces expensive single-ended SAW oscillators
- More cost effective than quartz oscillators, quartz crystals and clock ICs.
- Completely quartz-free

### Applications

- Communications and Networking Applications
- Consumer Electronics Applications
- Automotive Applications
- Industrial Applications
- Gigabit Ethernet
- 10 Gigabit Ethernet
- Fiber Channel
- Ethernet
- SATA/SAS
- USB 2.0
- PCI-Express

### Block Diagram

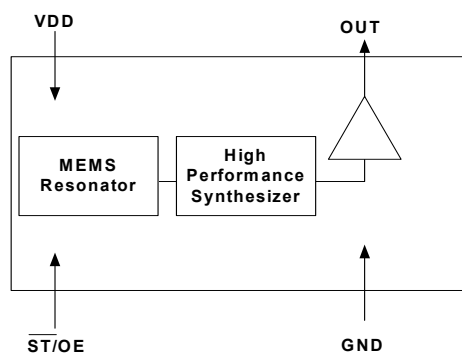

### Pinout

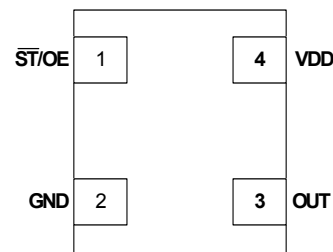

### Pin Description

Pin No.	Name	Pin Description
1	ST/OE	Standby/ Output Enable
2	GND	Connect to Ground
3	OUT	1 to 200 MHz Programmed Clock output
4	VDD	Connect to 1.8V / 2.5V / 2.8V / 3.3V

### Pin1

Pin #1 Functionality
<b>OE</b>
H or Open; specified frequency output
L: output is high impedance
<b>ST</b>
H or Open; specified frequency output
L: output is low level (weak pull down) oscillation stops

# SiT8102

## 1 to 200 MHz High Performance Oscillator



### Description

The SiT8102 is the next generation of the SiT8002 programmable oscillator with lower phase noise, lower jitter, and a wider frequency range. SiTime oscillators are the smallest, high-performance programmable oscillator available and are suitable for use in high speed serial communications, consumer, portable, industrial, automotive and computation.

This oscillator is packaged in standard low-cost plastic and chip-scale IC packages.

System reliability is also increased with the SiT8102 by eliminating the quartz crystal and improved immunity to the environmental effects of vibration, shock, strain, and humidity.

To order samples, go to [www.sitime.com](http://www.sitime.com) and click on Request Sample" link.

### Absolute Maximum Ratings

Attempted operation outside the absolute maximum ratings of the part may cause permanent damage to the part. Actual performance of the IC is only guaranteed within the operational specifications, not at absolute maximum ratings.

#### Absolute Maximum Table

Parameter	Min.	Max.	Unit
Storage Temperature	-65	150	°C
VDD	-0.5	+3.66	V
Electrostatic Discharge	–	2000	V
Theta JA ( with copper plane on VDD and GND)	–	75	°C/W
Theta JC (with PCB traces of 0.010 inch to all pins)	–	24	°C/W
Soldering Temperature (follow standard Pb free soldering guidelines)	–	260	°C
Number of Program Writes	–	1	NA
Program Retention over -40 to 125 °C, Process, VDD (0 to 3.65V)	–	1,000+	years

### Operating Conditions

Parameter	Min.	Typ.	Max.	Unit
Supply Voltages, VDD <sup>[1]</sup>	2.97	3.3	3.63	V
	2.52	2.8	3.08	V
	2.25	2.5	2.75	V
	1.7	1.8	1.9	V
Commercial Operating Temperature	0	–	70	°C
Extended Commercial Operating Temperature	-20	–	70	°C
Industrial Operating Temperature	-40	–	85	°C
Maximum Load Capacitance <sup>[2]</sup>	–	–	15	pF

### Environmental Compliance

Parameter	Condition/Test Method
Mechanical Shock	MIL-STD-883F, Method 2002
Mechanical Vibration	MIL-STD-883F, Method 2007
Temperature Cycle	JESD22, Method A104
Solderability	MIL-STD-883F, Method 2003
Moisture Sensitivity Level	MSL1 @ 260°C

#### Notes:

1. The 3.3V device can operate from 2.25V to 3.63V with higher output drive strength, however, the data sheet specifications cannot be guaranteed. Please contact factory for this option.
2. The output driver strength can be programmed to drive up to 50pF load. Please contact factory for this option.

**SiT8102****1 to 200 MHz High Performance Oscillator**

## DC Electrical Specifications

VDD = 3.3V ±10%, -40 to 85°C

Parameter	Condition	Min.	Typ.	Max.	Unit
Output Voltage High	IOH = -9 mA	90	–	–	%Vdd
Output Voltage Low	IOL = 9 mA	–	–	10	%Vdd
Input Voltage High	Pin 1	70	–	–	%Vdd
Input Voltage Low	Pin 1	–	–	30	%Vdd
Operating Current	Output frequency = 30 MHz, 15 pF load	–	–	26	mA
	Output frequency = 125 MHz, 15 pF load	–	–	34	mA
Standby Current	Output is weakly pulled down, ST = GND	–	30	50	µA
Power Up Time	Time from minimum power supply voltage to the first cycle (Guaranteed no runt pulses)	–	–	10	ms

VDD = 2.5V ±10% or VDD = 2.8V ±10%, -40 to 85°C

Parameter	Condition	Min.	Typ.	Max.	Unit
Output Voltage High	IOH = -7 mA	90	–	–	%Vdd
Output Voltage Low	IOL = 7mA	-	–	10	%Vdd
Input Voltage High	Pin 1	70	–	–	%Vdd
Input Voltage Low	Pin 1	–	–	30	%Vdd
Operating Current	Output frequency = 30 MHz, 15 pF load	–	–	26	mA
	Output frequency = 125 MHz, 15 pF load	–	–	31	mA
Standby Current	Output is weakly pulled down, ST = GND	–	30	50	µA
Power Up Time	Time from minimum power supply voltage to the first cycle (Guaranteed no runt pulses)	–	–	10	ms

VDD = 1.8V ±5%, -40 to 85°C

Parameter	Condition	Min.	Typ.	Max.	Unit
Output Voltage High	IOH = -5 mA	90	–	–	%Vdd
Output Voltage Low	IOL = 5 mA	-	–	10	%Vdd
Input Voltage High	Pin 1	70	–	–	%Vdd
Input Voltage Low	Pin 1	–	–	30	%Vdd
Operating Current	Output frequency = 30 MHz, 15 pF load	–	–	26	mA
	Output frequency = 125 MHz, 15 pF load	–	–	31	mA
Standby Current	Output is weakly pulled down, ST = GND	–	30	50	µA
Power Up Time	Time from minimum power supply voltage to the first cycle (Guaranteed no runt pulses)	–	–	10	ms

**SiT8102****1 to 200 MHz High Performance Oscillator****AC Electrical Specifications**

VDD = 3.3V ±10%, -40 to 85°C

Parameter	Condition	Min.	Typ.	Max.	Unit	
Clock Output Frequency		1	–	200	MHz	
Frequency Stability	Inclusive of initial tolerance, operating temp., rated power supply voltage change, load change	0 to 70°C	-10	–	+10	PPM
		-20 to 70°C -40 to 85°C	-15	–	+15	PPM
			-20	–	+20	PPM
			-25	–	+25	PPM
			-50	–	+50	PPM
-100	–	+100	PPM			
Aging	First year @ 25 °C	–	–	1	PPM	
Clock Output Duty Cycle	Output frequency= 1 to 125 MHz	45	–	55	%	
	Output frequency= 125 to 200 MHz	40	–	60	%	
Clock Output Rise Time	15 pF Load, 20% to 80% VDD	–	1.0	1.5	ns	
Clock Output Fall Time	15 pF Load, 80% to 20% VDD	–	1.0	1.5	ns	
RMS Period Jitter	Output frequency = 75 MHz	–	2.6	4	ps	
	Output frequency = 125 MHz	–	2.4	3.6	ps	
RMS Phase Jitter (Random)	Output frequency = 75 MHz (900 kHz to 7.5 MHz)	–	0.81	–	ps	
	Output frequency = 106.25 MHz (637kHz to 10 MHz)	–	1.64	–	ps	
	Output frequency = 125 MHz (1.875 to 20 MHz)	–	0.38	–	ps	

VDD = 2.5V ±10% or VDD = 2.8V ±10%, -40 to 85°C

Parameter	Condition	Min.	Typ.	Max.	Unit	
Clock Output Frequency		1	–	200	MHz	
Frequency Stability	Inclusive of initial tolerance, operating temp., rated power supply voltage change, load change	0 to 70°C	-10	–	+10	PPM
		-20 to 70°C -40 to 85°C	-15	–	+15	PPM
			-20	–	+20	PPM
			-25	–	+25	PPM
			-50	–	+50	PPM
-100	–	+100	PPM			
Aging	First year @ 25 °C	–	–	1	PPM	
Clock Output Duty Cycle	Output frequency= 1MHz to 125MHz	45	–	55	%	
	Output frequency= 125MHz to 200MHz	40	–	60	%	
Clock Output Rise Time	15 pF Load, 20% to 80% VDD	–	1.0	1.5	ns	
Clock Output Fall Time	15 pF Load, 80% to 20% VDD	–	1.0	1.5	ns	
RMS Period Jitter	Output frequency = 75 MHz	–	3	6	ps	
	Output frequency = 125 MHz	–	2.8	5	ps	
RMS Phase Jitter (Random)	Output frequency = 75 MHz (900 kHz to 7.5 MHz)	–	0.87	–	ps	
	Output frequency = 106.25 MHz (637kHz to 10 MHz)	–	1.7	–	ps	
	Output frequency = 125 MHz (1.875 to 20 MHz)	–	0.41	–	ps	

**SiT8102****1 to 200 MHz High Performance Oscillator**

VDD = 1.8V ±5%, -40 to 85°C

Parameter	Condition	Min.	Typ.	Max.	Unit	
Clock Output Frequency		1	–	200	MHz	
Frequency Stability	Inclusive of initial tolerance, operating temp., rated power supply voltage change, load change	0 to 70°C	-15	–	+15	PPM
		-20 to 70°C -40 to 85°C	-20	–	+20	PPM
			-25		+25	PPM
			-50		+50	PPM
			-100		+100	PPM
Aging	First year @ 25 °C	–	–	1	PPM	
Clock Output Duty Cycle	Output frequency= 1 MHz to 75 MHz	45	–	55	%	
	Output frequency= 75 MHz to 200 MHz	40	–	60	%	
Clock Output Rise Time	15 pF Load, 20% to 80% VDD	–	1.0	1.5	ns	
Clock Output Fall Time	15 pF Load, 80% to 20% VDD	–	1.0	1.5	ns	
RMS Period Jitter	Output frequency = 75 MHz	–	7.3	14	ps	
	Output frequency = 125 MHz	–	7.1	14	ps	
RMS Phase Jitter (Random)	Output frequency = 75 MHz (900 kHz to 7.5 MHz)	–	0.85	–	ps	
	Output frequency = 106.25 MHz (637kHz to 10 MHz)	–	1.72	–	ps	
	Output frequency = 125 MHz (1.875 to 20 MHz)	–	1.06	–	ps	

# SiT8102

## 1 to 200 MHz High Performance Oscillator



### Ordering Information

#### SiT8102AC-13-25E - 105.12345T

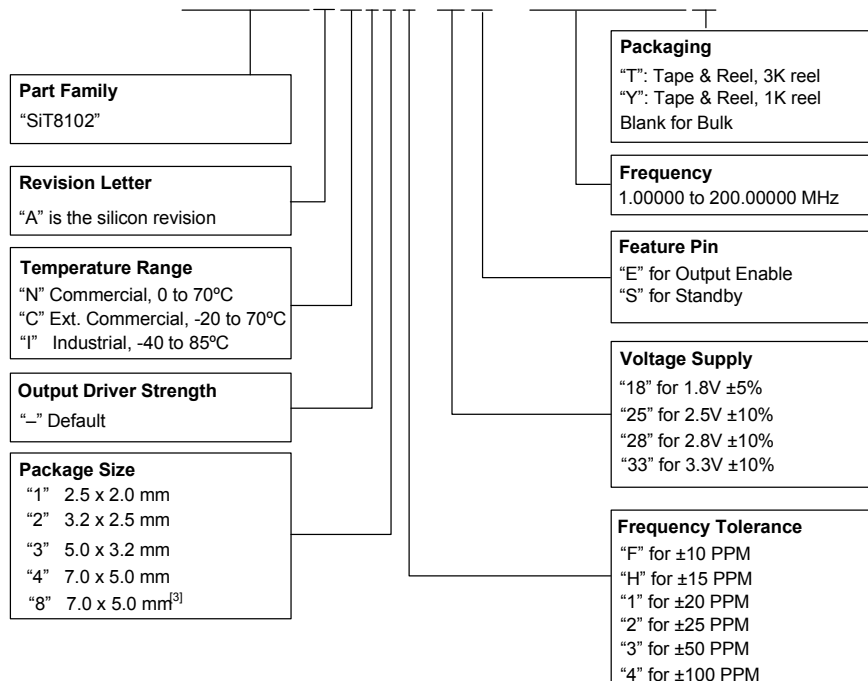
**Notes:**

3. Without Center Pad.

### Frequency Stability vs. Temperature Range Options

Frequency Stability (PPM)	Temperature Range	Supply Voltage		
		1.8 V	2.5 V	3.3 V
±10	N (0 to +70°C)	-	✓	✓
	C (-20 to +70°C)	-	-	-
	I (-40 to +85°C)	-	-	-
±15	N (0 to +70°C)	✓	✓	✓
	C (-20 to +70°C)	-	✓	✓
	I (-40 to +85°C)	-	✓	✓
±20	N (0 to +70°C)	✓	✓	✓
	C (-20 to +70°C)	✓	✓	✓
	I (-40 to +85°C)	✓	✓	✓
±25	N (0 to +70°C)	✓	✓	✓
	C (-20 to +70°C)	✓	✓	✓
	I (-40 to +85°C)	✓	✓	✓
±50	N (0 to +70°C)	✓	✓	✓
	C (-20 to +70°C)	✓	✓	✓
	I (-40 to +85°C)	✓	✓	✓

# SiT8102

## 1 to 200 MHz High Performance Oscillator



### Package Information [4,5]

Dimension (mm)

Land Pattern (recommended) (mm)<sup>[6]</sup>

#### 2.5 x 2.0 x 0.75mm

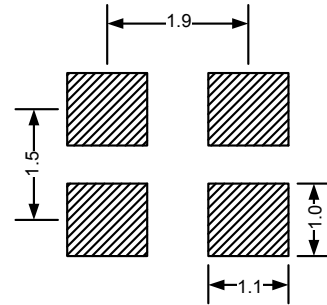
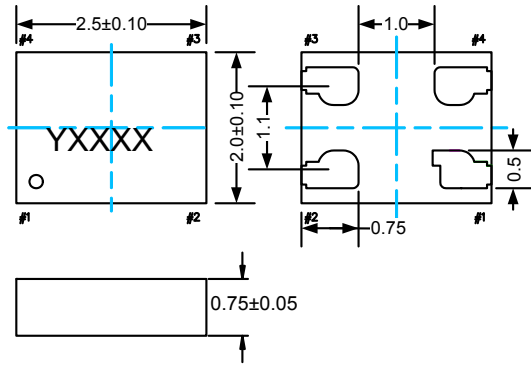

#### 3.2 x 2.5 x 0.75 mm

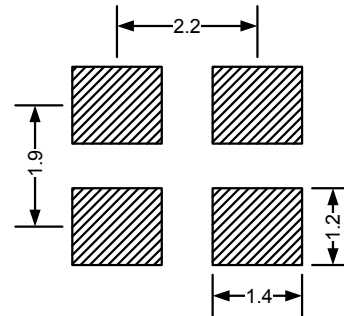
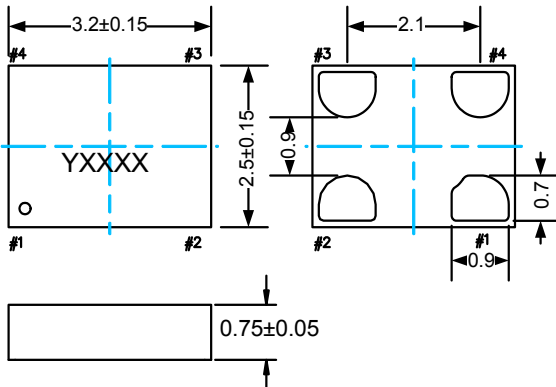

#### 5.0 x 3.2 x 0.75 mm

