

Features

- 32.768 kHz ± 5 ppm all-inclusive frequency stability
- In-system auto-calibration:
 - Compensates for board-level stress-induced frequency errors
 - Improves all-inclusive frequency stability
- World's smallest TCXO Footprint: 1.2 mm²
 - 1.5 x 0.8 mm CSP
 - No external bypass cap required
- Drives multiple loads and eliminates multiples XTALs
- Low integrated phase jitter (IPJ) suitable for multiplying up for portable audio: 2.5 ns_{RMS}
- Ultra-low power: 4.5 μ A
- Supply voltage: 1.8V $\pm 10\%$
- Operating temperature ranges: -20°C to +70°C, -40°C to +85°C
- Pb-free, RoHS and REACH compliant

Applications

- Smart watches, health and wellness monitors
- Ultra-accurate RTC reference clock
- Smart utility meters, E-meters
- Internet of Things (IoT)



Electrical Characteristics

Conditions: Min/Max limits are over temperature, V_{dd} = 1.8V $\pm 10\%$, unless otherwise stated. Typicals are at 25°C and V_{dd} = 1.8V.

Parameter	Symbol	Min.	Typ.	Max.	Unit	Condition
Frequency and Stability						
Output Frequency	F _{out}	32.768			kHz	
Total Frequency Stability after Overmold ^[1]	F _{stab}	-5		5	ppm	All inclusive, after overmold, post in-system calibration.
		-25		25	ppm	All inclusive, after overmold, before in-system calibration.
Total Frequency Stability without Overmold or Calibration ^[1]		-5		5	ppm	All inclusive, under influence of up to 5°C/sec temp gradient and board-level underfill.
Allan Deviation	AD		1e-8	4e-8	-	1 second averaging time.
First Year Frequency Aging	F _{aging}		± 1		ppm	T _A = 25°C, V _{dd} = 1.8V, with overmold.
Jitter and Frequency Response Performance						
Integrated Phase Jitter	IPJ		1.8	2.5	ns _{RMS}	Integration bandwidth = 100 Hz to 16.384 kHz. Inclusive of 50 mV peak-to-peak sinusoidal noise on V _{dd} . Noise frequency 100 Hz to 20 MHz.
RMS Period Jitter	PJ _{RMS}		2.5	4	ns _{RMS}	10,000 samples, per JEDEC standard 65B
Peak-to-Peak Period Jitter	PJ _{p-p}		20	35	ns _{p-p}	
Dynamic Temperature Frequency Response		-0.5		+0.5	ppm/sec	Under temp ramp up to 1.5°C/sec
Supply Voltage and Current Consumption						
Operating Supply Voltage	V _{dd}	1.62	1.8	1.98	V	
Supply Current	I _{dd}		4.5	5.3	μ A	No Load.
Start-up Time at Power-up	t _{start}			300	ms	Measured when supply reaches 90% of final V _{dd} to the first output pulse.
Operating Temperature Range						
Operating Temperature Range	Op_Temp	-20		70	°C	"C" ordering code.
		-40		85	°C	"I" ordering code.
LVC MOS Output						
Output Rise/Fall Time	t _r , t _f		9	20	ns	10-90% (V _{dd}), 15 pF Load.
Output Clock Duty Cycle	DC	45		55	%	
Output Voltage High	VOH	90%			V _{dd}	I _{OH} = -1 μ A
Output Voltage Low	VOL			10%	V _{dd}	I _{OL} = 1 μ A

Note:

1. Contact Factory for specific overmold conditions. Relative to 32.768 kHz, includes initial tolerance, over temp, V_{dd}, load, hysteresis, board-level underfill, and, 3x reflow. Tested with Agilent 53132A frequency counter. Measured with 100ms gate time for accurate frequency measurement.

Pin Configuration

CSP Pin	Symbol	I/O	Functionality
1	Auto-Cal or NC	Control Input	Used for communicating calibration information to the chip for improving stability in the presence of board level induced stresses. Leave pin floating (NC) when not using the calibration function.
2	CLK Out	OUT	Oscillator clock output.
3	Vdd	Power Supply	1.8V \pm 10% power supply. For most applications, the internal bypass filtering is acceptable. A PSNR plot is shown in the Typ Ops section. If power-supply bypassing is required, a 10-100 nF low ESR, ceramic capacitor is acceptable.
4	GND	Power Supply Ground	Connect to ground.

CSP Package (Top View)

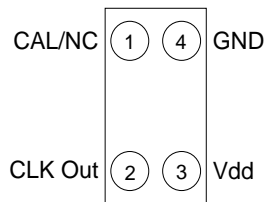

Absolute Maximum Ratings

Attempted operation outside the absolute maximum ratings may cause permanent damage to the part. Actual performance of the IC is only guaranteed within the operational specifications, not at absolute maximum ratings.

Parameters	Test Conditions	Value	Unit
Continuous Power Supply Voltage Range (Vdd)		-0.5 to 4.0	V
Continuous Maximum Operating Temperature Range		105	$^{\circ}$ C
Human Body Model (HBM) ESD Protection	JESD22-A114	2000	V
Charge-Device Model (CDM) ESD Protection	JESD22-C101	750	V
Machine Model (MM) ESD Protection	$T_A = 25^{\circ}$ C	200	V
Latch-up Tolerance	JESD78 Compliant		
Mechanical Shock Resistance	Mil 883, Method 2002	20,000	g
Mechanical Vibration Resistance	Mil 883, Method 2007	70	g
1508 CSP Junction Temperature		150	$^{\circ}$ C
Storage Temperature		-65 to 150	$^{\circ}$ C

System Block Diagram

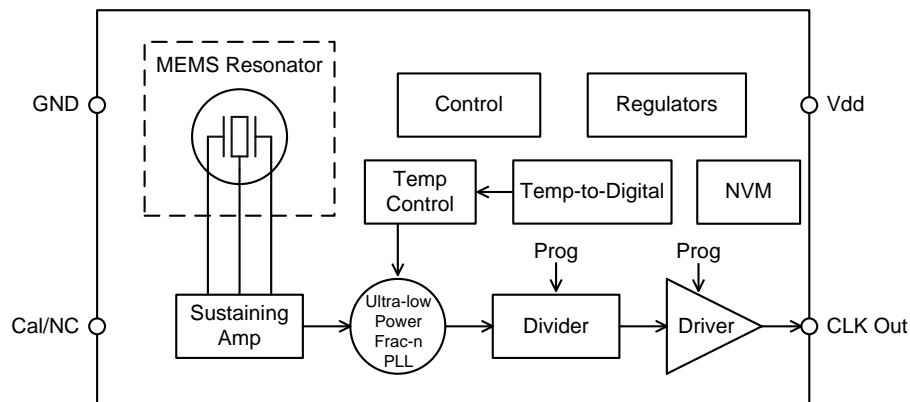

Figure 1. SiT1568 Block Diagram



Description

SiT1568 is an ultra-small and ultra-low power 32.768 kHz TCXO optimized for battery-powered applications. SiTime's silicon MEMS technology enables the first 32 kHz TCXO in the world's smallest footprint and chip-scale packaging (CSP). Typical supply current is 4.5 μ A under no load condition.

SiTime's MEMS oscillator consists of a MEMS resonator and a programmable analog circuit. SiT1568 MEMS resonator is built with SiTime's unique MEMS First™ process. A key manufacturing step is EpiSeal™ during which the MEMS resonator is annealed with temperatures over 1000°C. EpiSeal creates an extremely strong, clean, vacuum chamber that encapsulates the MEMS resonator and ensures the best performance and reliability. During EpiSeal, a poly silicon cap is grown on top of the resonator cavity, which eliminates the need for additional cap wafers or other exotic packaging. As a result, SiTime's MEMS resonator die can be used like any other semiconductor die. One unique result of SiTime's MEMS First and EpiSeal manufacturing processes is the capability to integrate SiTime's MEMS die with a SOC, ASIC, microprocessor or analog die within a package to eliminate external timing components and provide a highly integrated, smaller, cheaper solution to the customer.

TCXO Frequency Stability

SiT1568 is factory calibrated (trimmed) over multiple temperature points to guarantee extremely tight stability over temperature. Unlike quartz crystals that have a classic tuning fork parabola temperature curve with a 25°C turnover point with a 0.04 ppm/C² temperature coefficient, the SiT1568 temperature coefficient is calibrated and corrected over temperature with an active temperature correction circuit. The result is a 32 kHz TCXO with extremely tight frequency variation over the -40°C to +85°C temperature range.

When measuring the output frequency of SiT1568 with a frequency counter, it is important to make sure the counter's gate time is \geq 100 ms. Shorter gate times may lead to inaccurate measurements.

In-System Auto Calibration

SiT1568 provides a unique, in-system calibration feature that compensates for assembly-related frequency offsets for improved overall frequency stability. The on-chip auto-calibration function is performed one-time during the customer's production system manufacturing process. In order to initiate the one-time auto calibration process, refer to the pin 1 auto-calibration description.

After assembly, follow the calibration steps as shown in the flow chart (Figure 2). Connect pin 1 to a 10 MHz reference (GPS disciplined or equivalent) and monitor the SiT1568 CLK Out for status and error flags. A summary of these flags is shown in Table 1. SiT1568 will compare its 32.768 kHz (plus the assembly-related error) frequency to the accurate 10 MHz reference, calibrate (remove) the error and store the calibration in its internal non-volatile memory. The result is a calibrated 32.768 kHz output frequency with an overall stability (accuracy) of \pm 5 ppm. The entire auto-calibration process typically takes about 2 seconds.

Auto calibration is intended to be performed one time to remove the board-related offset errors. The auto-calibration procedure can be repeated if process fails during the initial steps (see Table 1). The maximum number of retries is determined by the customer.

Dynamic Temperature Frequency Response

Dynamic Temperature Frequency Response is the rate of frequency change during temperature ramps. This is an important performance metric when the oscillator is mounted near a high power component (e.g. SoC or power management) that may rapidly change the temperature of surrounding components.

For moderate temperature ramp rates (< 2°C/sec), the dynamic response is primarily determined by the steady-state frequency vs. temperature of the device. The best dynamic response is obtained from parts which have been trimmed to be flat in frequency over temperature.

For high temperature ramp rates (>5°C/sec), the latency in the temperature compensation loop contributes a larger frequency error, which is dependent on the temperature compensation update rate. This part achieves excellent performance at 3Hz update rate. This device family supports faster update rates for further reducing dynamic frequency error at the expense of slightly increased current consumption.



Figure 2. Initial Offset Auto-Calibration Procedure

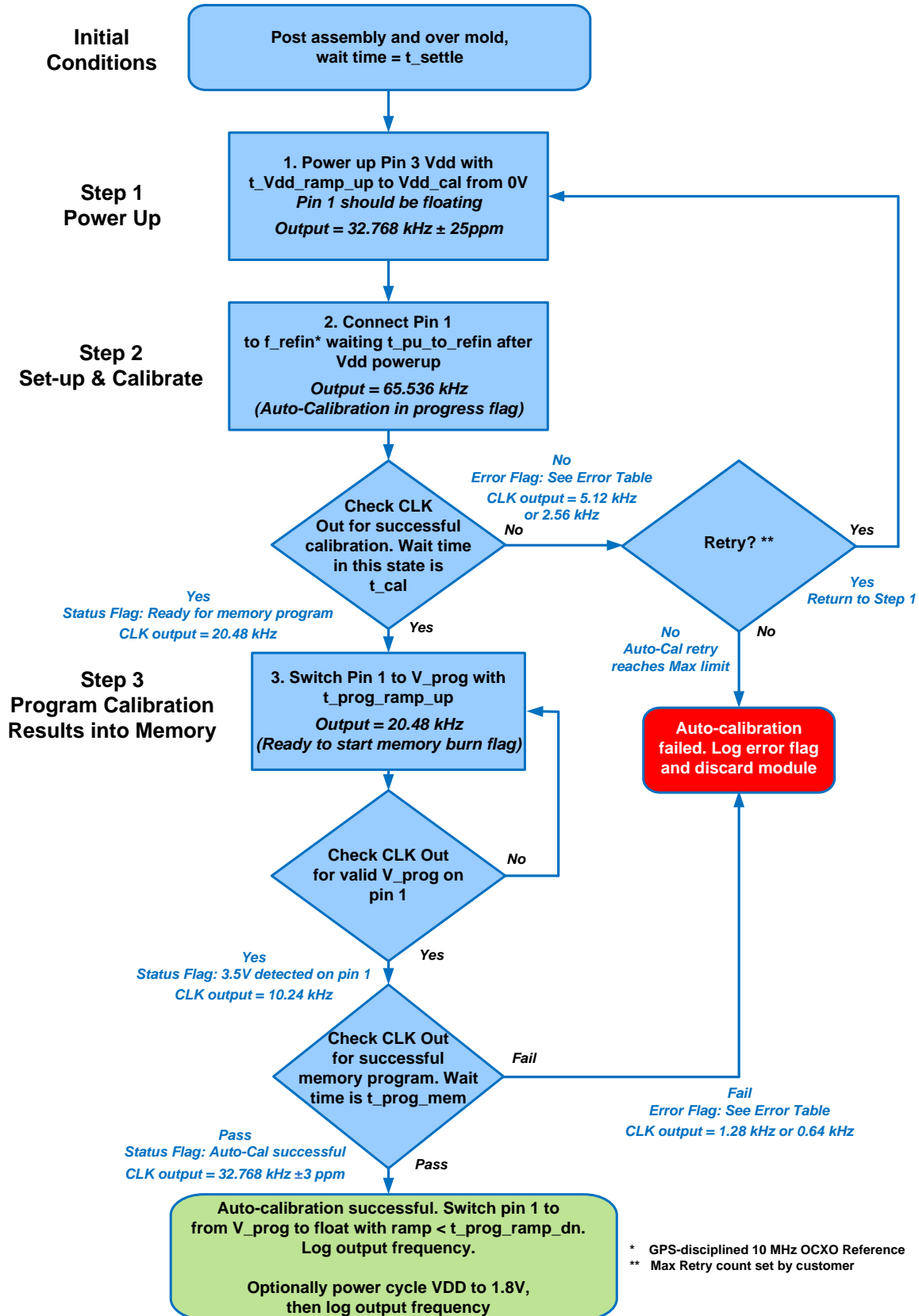



In-System Auto-Calibration

Pin 1 Auto-Calibration Mode DC Electrical Characteristics

Parameter	Symbol	Min.	Typ.	Max.	Unit	Condition
Input Impedance	Z_IN	80			kΩ	Internal pull-down
Input VIH	VIH	70%			V _{dd}	
Input VIL	VIL			30%	V _{dd}	
Input Overshoot Voltage	V_IN_OD			75	mV	
Program Voltage	V_prog	3.4	3.5	3.63	V	Pin 1 NVM program voltage
Program Current	I_prog			30	mA _{pk}	Peak current required on pin 1 during auto-calibration
				5	mA _{avg}	Average current required on pin 1 during auto-calibration
Auto-Cal Voltage Noise Ripple				50	mV _{pp}	Max noise on 3.5V auto-calibration voltage (pin 1)
Auto-Cal V _{dd} Supply	V _{dd_cal}	1.71	1.8	1.98	V	V _{dd} (pin 3) supply voltage during auto-calibration
V _{dd} Bypass Capacitor			0.1		μF	V _{dd} (pin 3) bypass cap required during auto-calibration
Pin 3 I _{dd} Prog Current	I _{dd_prog}			1	mA	I _{dd} (pin 3) current required during auto-calibration
Pin 3 Min Power Down Threshold Voltage	V _{dd_pd}			0.7	V	Pin 1 V _{dd} threshold to guarantee internal device power-down

Auto-Calibration Mode Timing Characteristics

Parameter	Symbol	Min.	Typ.	Max.	Unit	Condition
Post System Assy Settling Time	t_settle	24			hr	Wait time between > absolute max storage temp exposure (150°C) and auto-cal start
Pin 3 Power Supply Ramp Rate	t_V _{dd_ramp}			100	ms	Ramp rate for V _{dd} pin during auto-calibration
Auto-Cal Ref-in Wait Time	t_pu_to_refin	0.5			sec	Time to supply auto-cal clock on pin 1 after within spec V _{dd} (pin 3)
Ref In Detection Time	t_refin_to_CLK_flag_65k			1.2	ms	Time to detect 10 MHz auto-cal reference inputs, 65.536 kHz output
Auto-Cal Time	t_cal		2	5	sec	Time in Step 2, auto-calibration
Pin 1 Float Duration	t_refin_to_float	200			μs	Pin 1 float time required prior to applying prog voltage
Pin 1 Prog Voltage Ramp Rate	t_prog_ramp_up	1		100	μs	Ramp rate on Cal pin to V _{prog} during auto-calibration
Prog Voltage Detection Time	t_prog_to_CLK_flag_10k			100	ms	Time to detect program voltage, 10.24 kHz output flag
Pin 1 Prog Voltage Ramp Down	t_prog_ramp_dn	1		100	μs	Time to power-down prog voltage
Memory Programming Time	t_prog_mem			100	ms	Time in Step 3, Memory program
Pin 3 Power-Down Delay	t_prog_to_pd	1			ms	Pin 3 V _{dd} power-down delay from Pin 1 prog voltage power down

Auto-Calibration Reference Clock Characteristics

Parameter	Symbol	Min.	Typ.	Max.	Unit	Condition
Auto-Cal Ref Clock Freq	f_refin	9.999999	10	10.000001	MHz	(10 MHz ± 100ppb) Correct reference frequency for auto-calibration
Auto-Cal Ref Clock Rise/Fall Time	t_refin_r/f	4		20	ns	20/80%; Rise and falltime of the auto-cal 10 MHz ref clock
Auto-Cal Ref Clock Duty Cycle	dc_refin	40		60	%	
Auto-Cal Ref Clock Period Jitter	pj_refin			200	pS _{RMS}	
Auto-Cal Ref Clock Allan Deviation	ad_refin			10	ppb	For averaging time = 1 second

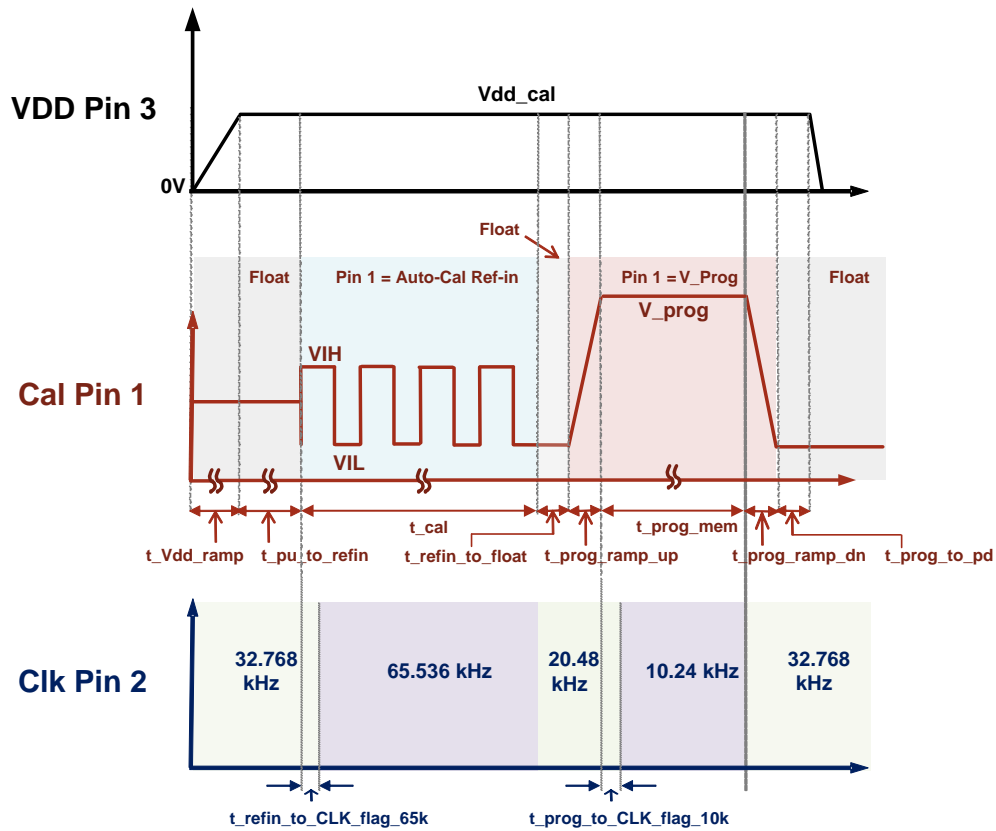

Figure 3. Auto-Calibration Timing Diagram

Table 1. Auto-Calibration Status and Error Flags

Flag Name	Output Frequency ^[2]	Recommended Minimum Gate Time	Status or Error Flag	Retry Calibration
Auto-Calibration in progress	65.536 kHz	10 ms	Status	N/A
Ready to start memory burn	20.48 kHz	10 ms	Status	N/A
3.3V on Pin 1 detected	10.24 kHz	10 ms	Status	N/A
Auto-Calibration successful	32.768 kHz \pm 3ppm	100 ms	Status	No
10 MHz reference lost during calibration step3	5.12 kHz	10 ms	Error	Yes
Frequency correction out of range in step 3	2.56 kHz	10 ms	Error	Yes
Memory burn failed in step 3	1.28 kHz	10 ms	Error	No
3.3V lost on Pin 1 during memory burn step3	0.64 kHz	10 ms	Error	No

Note:

2. Frequency tolerance is \pm 5% except for 32 kHz frequency output.

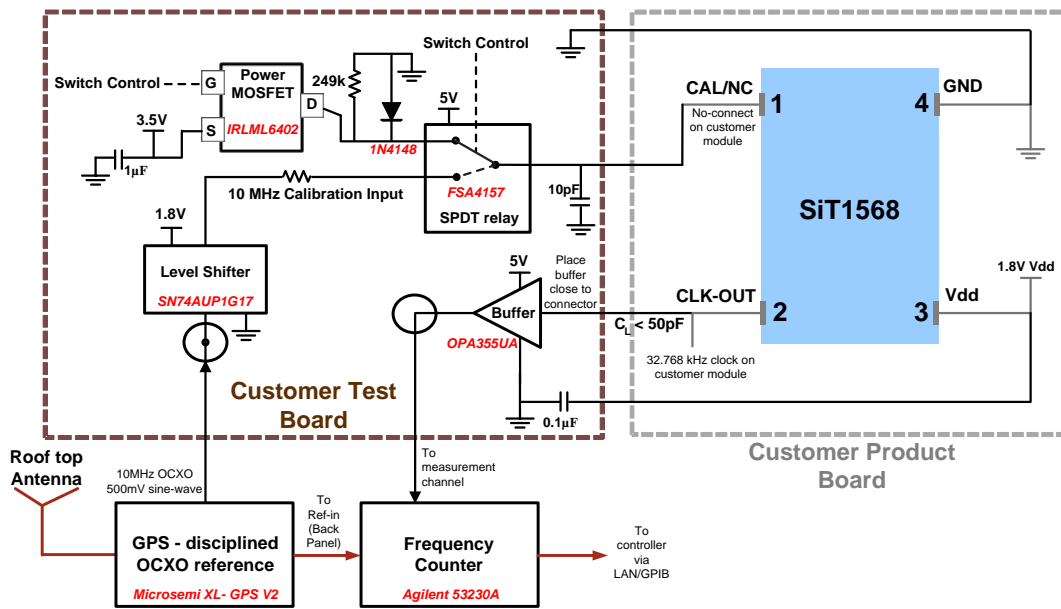

Figure 4. In-System Auto-Calibration Hardware Interface



Typical Operating Curves

($T_A = 25^\circ\text{C}$, $V_{DD} = 1.8\text{V}$, unless otherwise stated)

Frequency Stability over Temperature (Post Reflow)

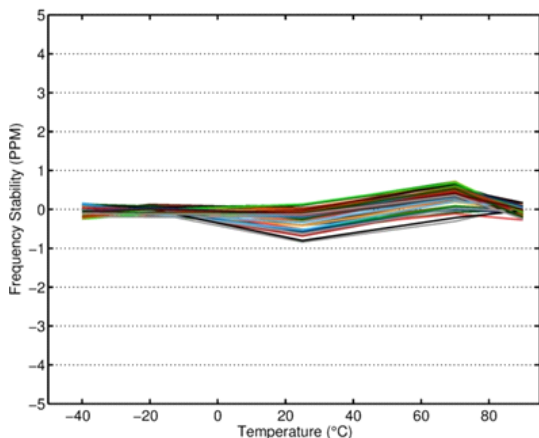

Supply Current over Temperature

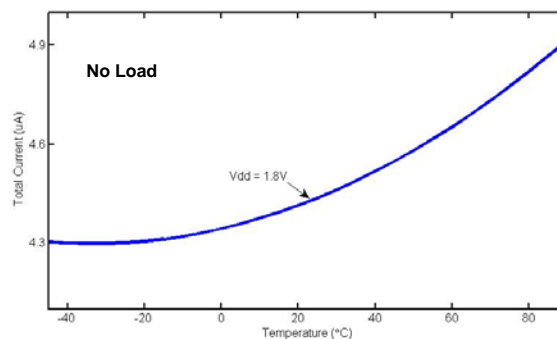

Start-up and Steady-State Current Profile

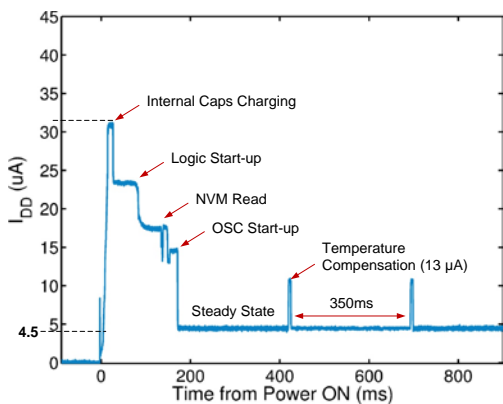

LVC MOS Output Swing



Power Supply Noise Rejection (PSNR)

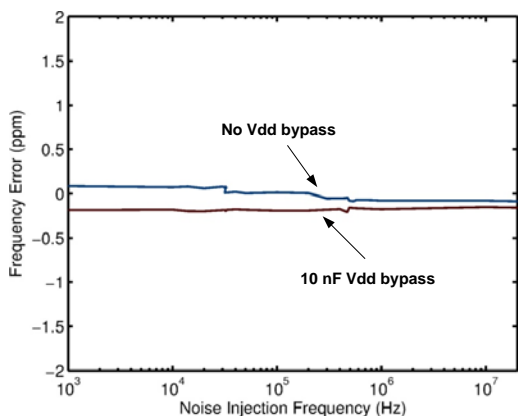



Dynamic Frequency Response for Moderate Temperature Ramps

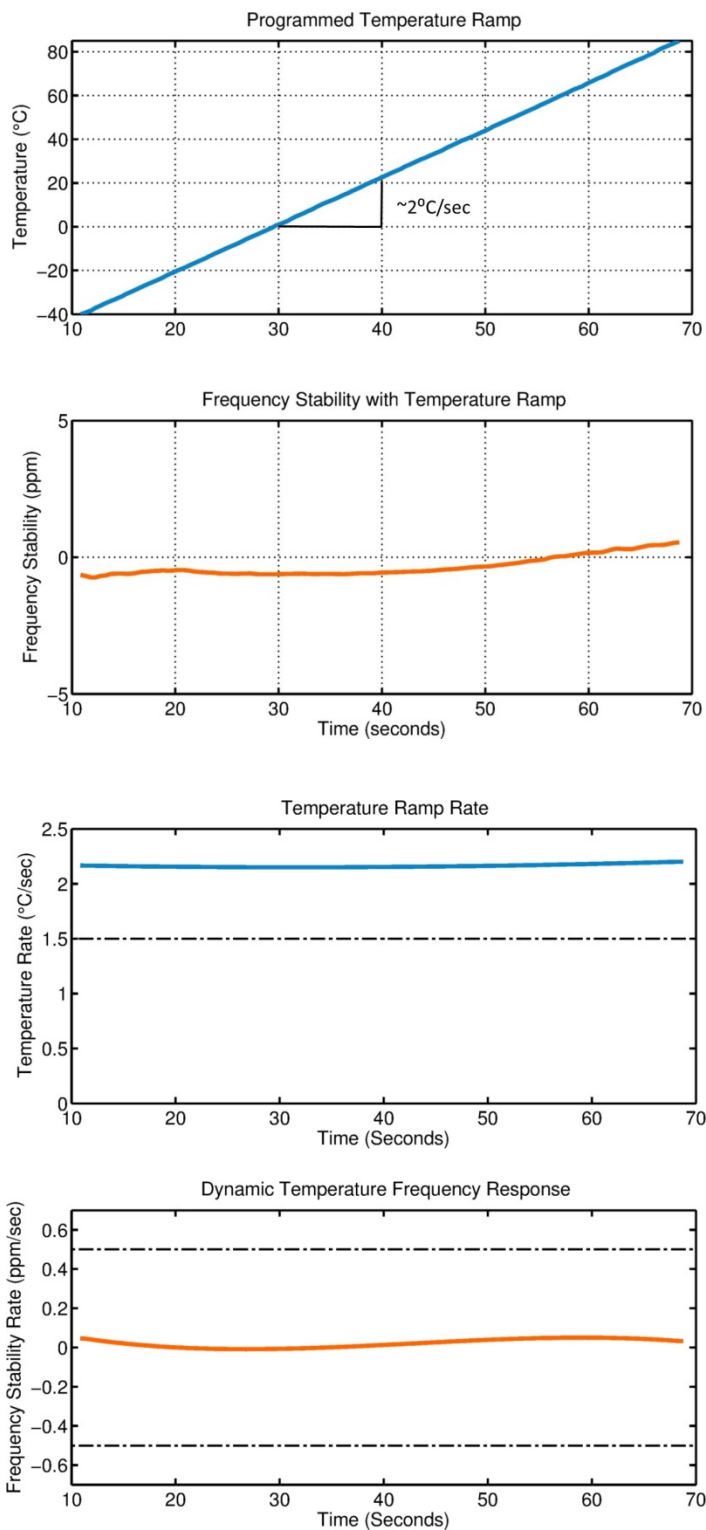

Frequency accuracy under a moderate temperature ramp up to $2^{\circ}\text{C}/\text{sec}$ is limited by the TCXO's trimmed accuracy of the frequency stability over-temperature.

Note:

3. Measured relative to 32.768 kHz.



Dynamic Frequency Response for Fast Temperature Ramps

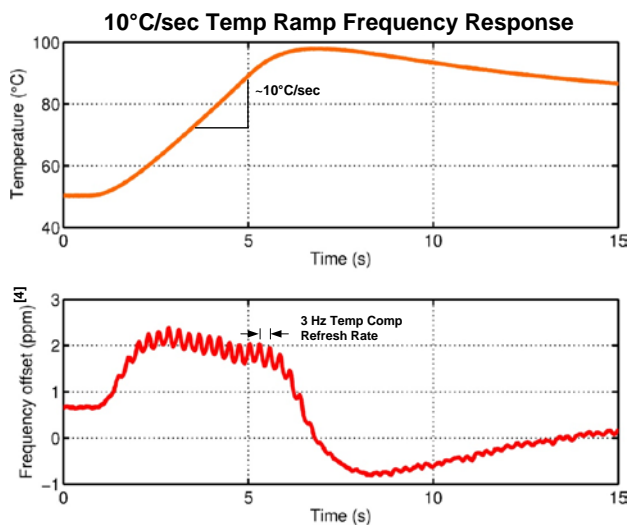
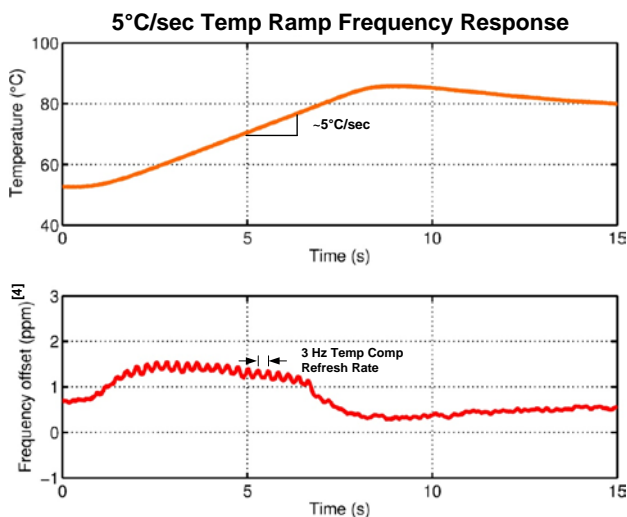

For temperature ramps >5°C/sec, the frequency accuracy is limited by the update rate of the temperature compensation path (see the 5°C/sec and 10°C/sec plots).

Contact Factory for applications that require improved dynamic performance.

Note:

- 4. Referenced to 32.768 kHz.

Dimensions and Patterns

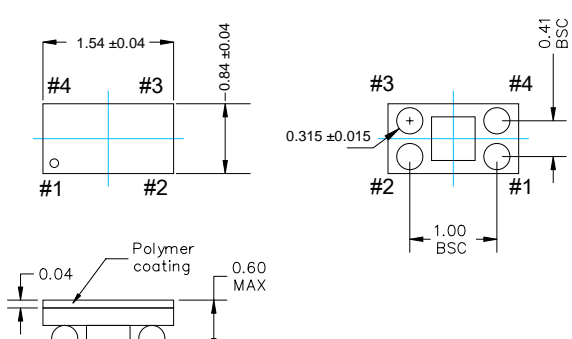
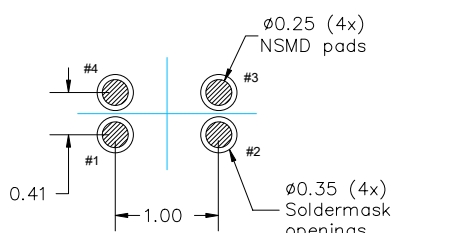
Package Size – Dimensions (Unit: mm)	Recommended Land Pattern (Unit: mm)
<p>1.55 x 0.85 mm CSP</p> 	 <p>(soldermask openings shown with heavy dashed line)</p> <p>Recommend 4-mil (0.1mm) stencil thickness</p>

Manufacturing Guidelines

- 1) No Ultrasonic or Megasonic cleaning: Do not subject the SiT1568 to an ultrasonic or megasonic cleaning environment. Permanent damage or long term reliability issues may occur.
- 2) Applying board-level underfill and overmold is acceptable and will not impact the reliability of the device. Any post assembly frequency shift can be calibrated with the in-system auto-calibration feature.
- 3) Reflow profile, per JESD22-A113D.
- 4) For additional manufacturing guidelines and marking/tape-reel instructions, click on the following link: http://www.sitime.com/component/docman/doc_download/243-manufacturing-notes-for-sitime-oscillators



Ordering Information

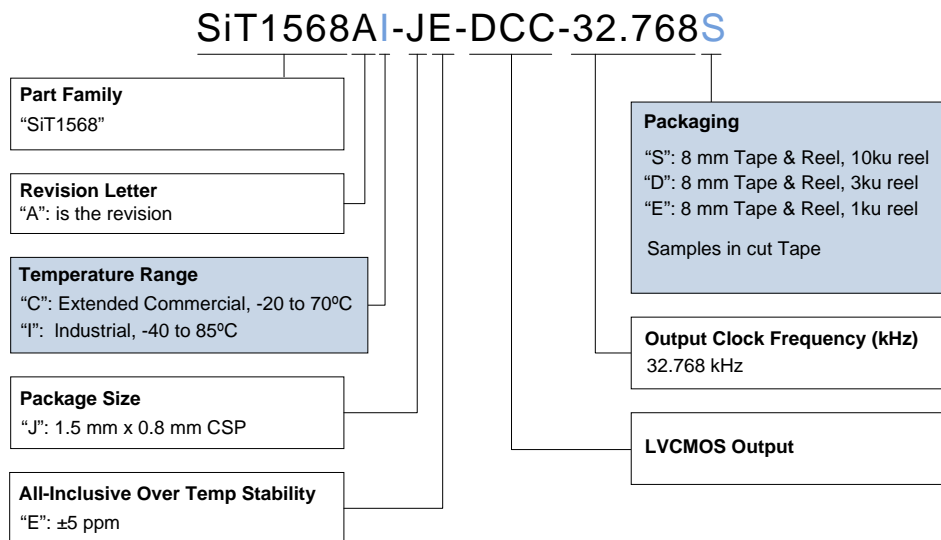

Revision History

Version	Release Date	Change Summary
0.5	6/30/15	Advanced datasheet initial release
0.8	3/10/16	Preliminary datasheet initial release

© SiTime Corporation 2016. The information contained herein is subject to change at any time without notice. SiTime assumes no responsibility or liability for any loss, damage or defect of a Product which is caused in whole or in part by (i) use of any circuitry other than circuitry embodied in a SiTime product, (ii) misuse or abuse including static discharge, neglect or accident, (iii) unauthorized modification or repairs which have been soldered or altered during assembly and are not capable of being tested by SiTime under its normal test conditions, or (iv) improper installation, storage, handling, warehousing or transportation, or (v) being subjected to unusual physical, thermal, or electrical stress.

Disclaimer: SiTime makes no warranty of any kind, express or implied, with regard to this material, and specifically disclaims any and all express or implied warranties, either in fact or by operation of law, statutory or otherwise, including the implied warranties of merchantability and fitness for use or a particular purpose, and any implied warranty arising from course of dealing or usage of trade, as well as any common-law duties relating to accuracy or lack of negligence, with respect to this material, any SiTime product and any product documentation. Products sold by SiTime are not suitable or intended to be used in a life support application or component, to operate nuclear facilities, or in other mission critical applications where human life may be involved or at stake. All sales are made conditioned upon compliance with the critical uses policy set forth below.

CRITICAL USE EXCLUSION POLICY

BUYER AGREES NOT TO USE SITIME'S PRODUCTS FOR ANY APPLICATION OR IN ANY COMPONENTS USED IN LIFE SUPPORT DEVICES OR TO OPERATE NUCLEAR FACILITIES OR FOR USE IN OTHER MISSION-CRITICAL APPLICATIONS OR COMPONENTS WHERE HUMAN LIFE OR PROPERTY MAY BE AT STAKE.

SiTime owns all rights, title and interest to the intellectual property related to SiTime's products, including any software, firmware, copyright, patent, or trademark. The sale of SiTime products does not convey or imply any license under patent or other rights. SiTime retains the copyright and trademark rights in all documents, catalogs and plans supplied pursuant to or ancillary to the sale of products or services by SiTime. Unless otherwise agreed to in writing by SiTime, any reproduction, modification, translation, compilation, or representation of this material shall be strictly prohibited.