

SiT8021

Ultra-Small, 1 to 26 MHz Oscillator



Description

The SiT8021 is the industry's smallest and the lowest power MHz oscillator. With 0.1 mW of active power consumption at 3.072 MHz output frequency, this μ Power oscillator enables longer battery life for a wearable, IoT or mobile device compared to a quartz-based oscillator or resonator.

The device comes in the smallest 1.5 mm x 0.8 mm package. The unique combination of ultra-low power, ultra-small package and flexible output frequency makes it ideal for power sensitive and space constrained applications including:

- Tablets
- Fitness bands
- Health and medical monitoring
- Wearables
- Portable audio
- Input devices
- IoT devices

Features

- Ultra-low current consumption of 60 μ A at 3.072 MHz
- Ultra-small 1.5 mm x 0.8 mm package
- 1 to 26 MHz with 6 decimal places of accuracy
- Operating temperature from -40°C to 85°C. Contact SiTime for -40°C to 105°C option
- Frequency stability as low as ± 100 ppm. Contact SiTime for ± 25 ppm or ± 50 ppm options
- Programmable output drive strength for best EMI or driving multiple loads
- Ultra-light weight of 1.28 mg
- RoHS and REACH compliant, Pb-free, Halogen-free and Antimony-free



INSTANT
SAMPLES



GREEN
SOLUTIONS



LIFETIME
WARRANTY



Electrical Specifications

Table 1. Electrical Characteristics

All Min and Max limits are specified over temperature and rated operating voltage with 15 pF output load unless otherwise stated. Typical values are at 25°C and nominal supply voltage.

Parameters	Symbol	Min.	Typ.	Max.	Unit	Condition
Frequency Range						
Output Frequency Range	f	1.000000		26.000000	MHz	
Frequency Stability and Aging						
Initial Tolerance	f_tol	-15	–	+15	ppm	Frequency offset at 25°C post reflow
Frequency Stability	f_stab	-100	–	+100	ppm	Inclusive of initial tolerance, and variations over operating temperature, rated power supply voltage and output load. Contact SiTime for ± 25 or ± 50 ppm options.
First Year Aging	f_1year	-3		+3	ppm	at 25°C
Operating Temperature Range						
Operating Temperature Range	T_use	-20	–	+70	°C	Extended Commercial
		-40	–	+85	°C	Industrial. Contact SiTime for -40°C to 105°C option.
Supply Voltage and Current Consumption						
Supply Voltage	VDD	1.62	1.8	1.98	V	Contact SiTime for 3.3V option
Current Consumption ^[1]	IDD	–	60	–	μ A	f = 3.072 MHz, no load
		–	110	130	μ A	f = 6.144 MHz, no load
		–	230	270	μ A	f = 6.144 MHz, 10 pF load
		–	160	–	μ A	f = 12 MHz, no load
Standby Current	I_std	–	0.7	1.3	μ A	ST pin = HIGH, output is weakly pulled down
LVC MOS Output Characteristics						
Duty Cycle	DC	45	–	55	%	
Rise/Fall Time	T_r, T_f	–	4	8	ns	20% - 80%. Contact SiTime for other programmable rise/fall options
Output High Voltage	VOH	90%	–	–	VDD	IOH = -0.5 mA
Output Low Voltage	VOL	–	–	10%	VDD	IOL = 0.5 mA
Input Characteristics						
Input High Voltage	VIH	80%	–	–	VDD	
Input Low Voltage	VIL	–	–	20%	VDD	
Input Slew Rate	In-slew	10	–	–	V/ μ s	
Input Pull-down Impedance	Z_in	300	–	–	k Ω	Active mode (ST pin = LOW)
		2.5	4	–	M Ω	Standby mode (ST pin = HIGH)

SiT8021

Ultra-Small, 1 to 26 MHz Oscillator



Electrical Specifications

Table 1. Electrical Characteristics

All Min and Max limits are specified over temperature and rated operating voltage with 15 pF output load unless otherwise stated. Typical values are at 25°C and nominal supply voltage.

Parameters	Symbol	Min.	Typ.	Max.	Unit	Condition
Startup, Standby and Resume Timing						
Startup Time	T_start	–	75	150	ms	Measured from the time VDD reaches 90% of its final value
Standby Time	T_stdby	–	–	20	μs	Measured from the time ST pin crosses 50% threshold
Resume Time	T_resume	–	2	3	ms	Measured from the time ST pin crosses 50% threshold
Jitter						
RMS Period Jitter	T_jitt	–	75	110	ps	f = 6.144 MHz
RMS Phase Jitter	T_phj	–	0.8	2.5	ns	f = 6.144 MHz, Integration bandwidth = 100 Hz to 40 kHz Note 2

Notes:

- Current consumption with load is a function of the output frequency and output load. For any given output frequency, the capacitive loading will increase current consumption equal to $C_{load} \cdot VDD \cdot f$ (MHz).
- Max spec inclusive of 25 mV peak-to-peak sinusoidal noise on VDD. Noise frequency 100 Hz to 20 MHz.

Table 2. Pin Description

Pin	Symbol		Functionality
1	ST	Input	L: Specified frequency output H: Output is low (weak pull down). Device goes to the standby mode. Supply current reduces to I_std.
2	OUT	Output	LVC MOS clock output
3	VDD	Power	Supply voltage. Bypass with a 0.01μF X7R capacitor.
4	GND	Power	Connect to ground

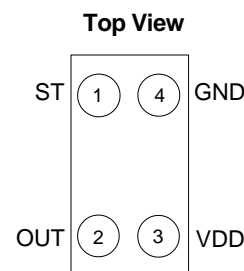

Figure 1. Pin Assignments

Table 3. Absolute Maximum Limits

Attempted operation outside the absolute maximum ratings may cause permanent damage to the part. Actual performance of the IC is only guaranteed within the operational specifications, not at absolute maximum ratings.

Parameter	Test Condition	Value	Unit
Continuous Power Supply Voltage Range (VDD)		-0.5 to 3.63	V
Short Duration Maximum Power Supply Voltage (VDD)	<30 seconds	4.0	V
Continuous Maximum Operating Temperature		105	°C
Short Duration Maximum Operating Temperature	≤30 seconds	125	°C
Human Body Model (HBM) ESD Protection	JESD22-A115	2000	V
Charge-Device Model (CDM) ESD Protection	JESD22-C101	750	V
Machine Model (MM) ESD Protection	T _A = 25°C	200	V
Latch-up Tolerance	JESD78 Compliant		
Mechanical Shock Resistance	MII 883, Method 2002	10,000	g
Mechanical Vibration Resistance	MII 883, Method 2007	70	g
1508 CSP Junction Temperature		150	°C
Storage Temperature		-65 to 150	°C
Soldering Temperature (follow standard Pb free soldering guidelines)	–	260	°C

SiT8021

Ultra-Small, 1 to 26 MHz Oscillator



Block Diagram

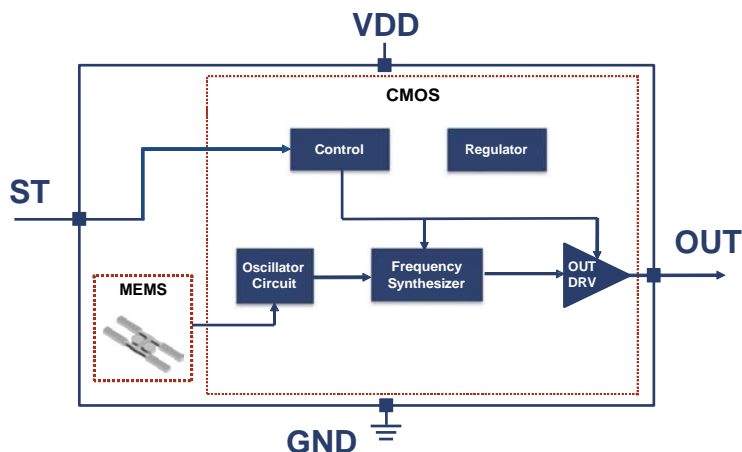

Figure 2. SiT8021 Block Diagram

Device Operating Modes and Outputs

The SiT8021 supports a $\leq 0.7 \mu\text{A}$ standby mode for battery-powered and other power sensitive applications. The switching between the active and standby modes is controlled by the logic level on the ST pin as shown in the table below.

Table 4. Operating Modes and Output States

ST Pin	MODE	OUTPUT	IDD Example
LOW	Active	Specified frequency	60 μA @ 3.072 MHz
FLOAT	Active with 200 k Ω internal pull-down	Specified frequency	60 μA @ 3.072 MHz
HIGH	Standby	Hi-Z, pulled-down with 1 M Ω impedance	1.3 μA

Active Mode

The SiT8021 operates in the active mode when the ST pin is at logic LOW or FLOAT. In the active mode, the device uses the on-chip frequency synthesizer to generate an output from the internal MEMS resonator reference. The frequency of the output is factory programmed based on the device ordering code.

Standby Mode

The SiT8021 operates in the standby mode when the ST pin is at logic HIGH. In the standby mode, all internal circuits with the exception of the MEMS oscillator circuit and the ST pin detection logic are turned off to reduce power consumption. While in standby mode, the input impedance of the ST pin is increased to further reduce system-level power consumption. The output driver of the device in the standby mode is pulled-down with 1 M Ω impedance.

Output During Startup and Resume

The SiT8021 starts up with the output disabled. The output is enabled once all internal circuit blocks are active, and logic LOW or FLOAT is detected on the ST pin.

As shown in Table 4, logic HIGH at the ST pin forces the SiT8021 into the “standby” state, causing the output to disable. Upon pulling the ST pin LOW, the device enters the “resume” state, keeping the output disabled. Once the “resume” state ends, the device output enables.

The first clock pulse after startup or resume is accurate to the rated stability.

Low Power Design Guidelines

For high EM noise environments, we recommend the following design guidelines:

- Place oscillator as far away from EM noise sources as possible (e.g., high-voltage switching regulators, motor drive control).
- Route noisy PCB traces, such as digital data lines or high di/dt power supply lines, away from the SiTime oscillator.
- Place a solid GND plane underneath the SiTime oscillator to shield the oscillator from noisy traces on the other board layers.

Manufacturing Guidelines

- No Ultrasonic or Megasonic Cleaning: Do not subject the SiT8021 to an ultrasonic or megasonic cleaning environment. Permanent damage or long-term reliability issues to the device may occur in such an event.
- Applying board-level underfill (BLUF) to the device is acceptable, but will cause a slight shift of few ppm in the initial frequency tolerance. Tested with UF3810, UF3808, and FP4530 underfill.
- Reflow profile, per JESD22-A113D.
- For additional manufacturing guidelines and marking/tape-reel instructions, click on the following link: http://www.sitime.com/component/docman/doc_download/243-manufacturing-notes-for-sitime-oscillators

SiT8021

Ultra-Small, 1 to 26 MHz Oscillator



Test Circuit and Waveform

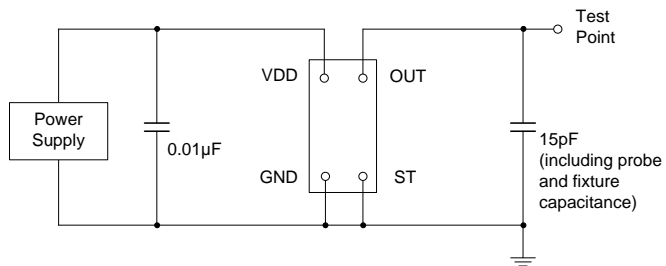

Figure 3. Test Circuit

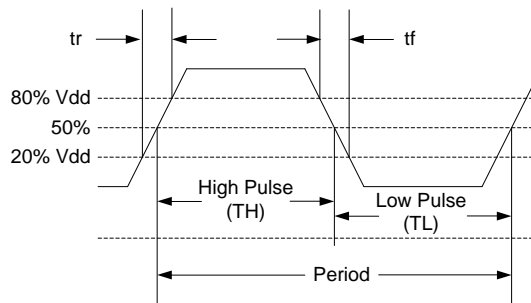
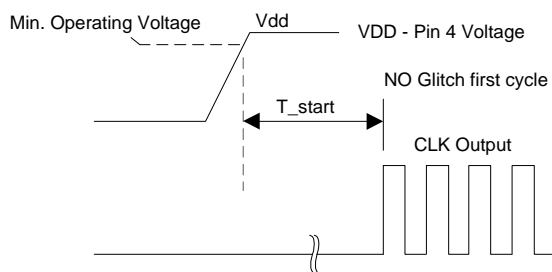

Figure 4. Waveform^[3]

Note:

3. Duty Cycle is computed as $Duty\ Cycle = TH/Period$.

Timing Diagram



T_start: Time to valid clock output from power on

Figure 5. Startup Timing^[4, 5]

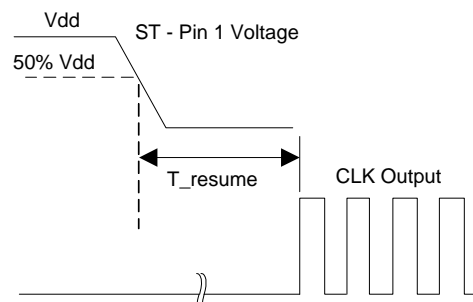

T_resume: Time to valid clock output from the time ST pin crosses 50% threshold

Figure 6. Resume Timing^[4, 5]

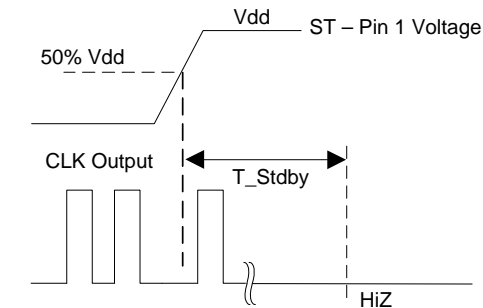

T_Stdby: Time for output to go high-Z from the time ST pin crosses 50% threshold

Figure 7. Standby Timing^[4]

Notes:

- 4. SiT8021 supports “no runt” pulses and “no glitch” output during startup or resume.
- 5. SiT8021 supports gated output which is accurate within rated frequency stability from the first cycle.

SiT8021

Ultra-Small, 1 to 26 MHz Oscillator



The Smart Timing Choice™

Performance Plots^[6]

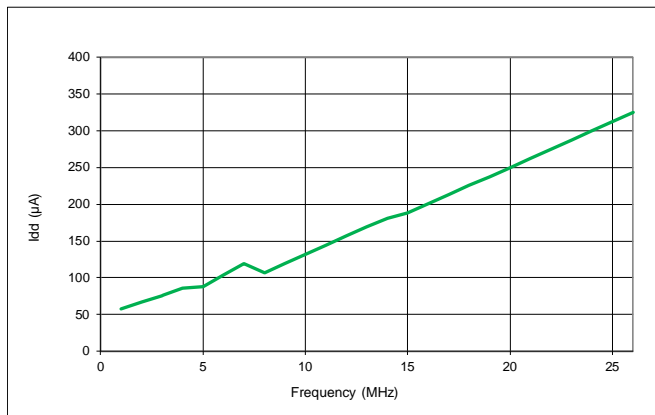

Figure 8. I_{dd} vs Frequency without load

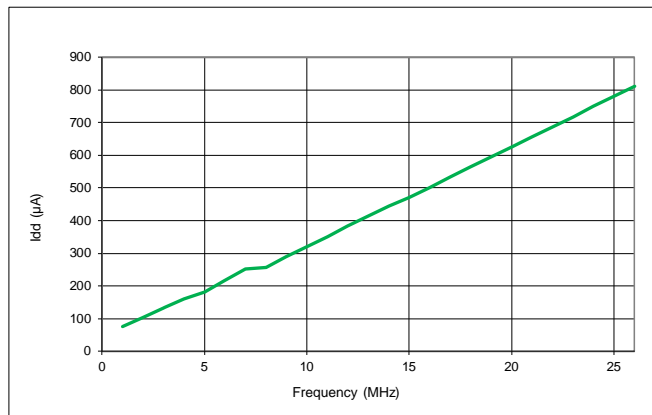

Figure 9. I_{dd} vs Frequency with 10pF load

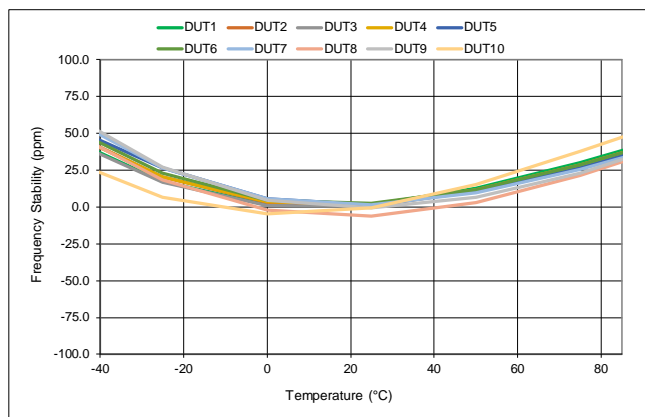

Figure 10. Frequency vs Temperature

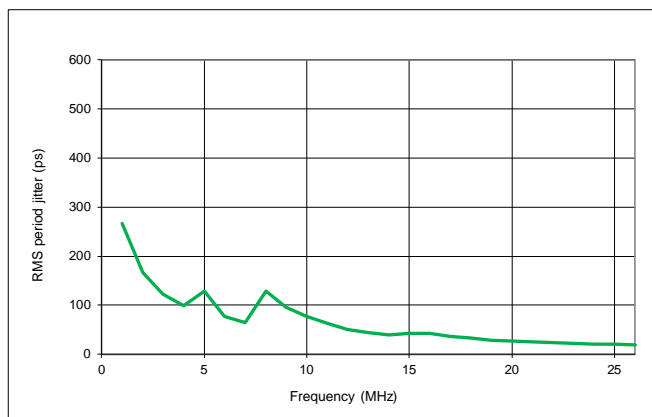

Figure 11. RMS Period Jitter vs Frequency

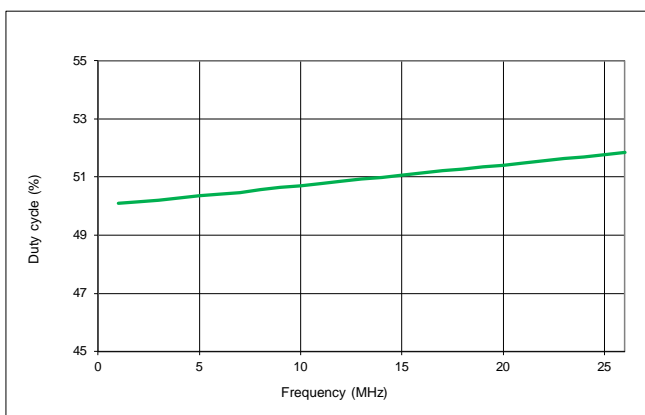

Figure 12. Duty Cycle vs Frequency

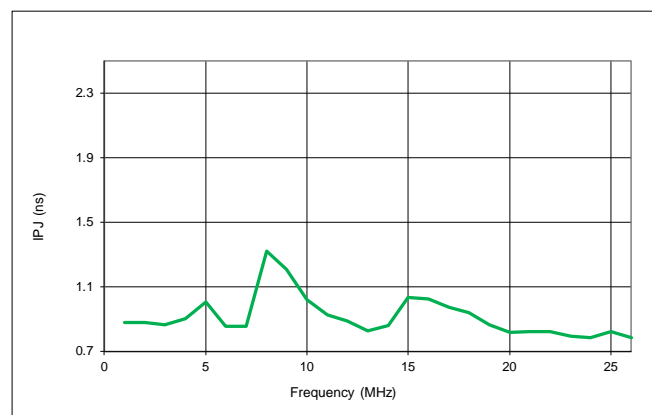

Figure 13. RMS Phase Jitter Random vs Frequency^[7]

SiT8021

Ultra-Small, 1 to 26 MHz Oscillator



Performance Plots^[6]

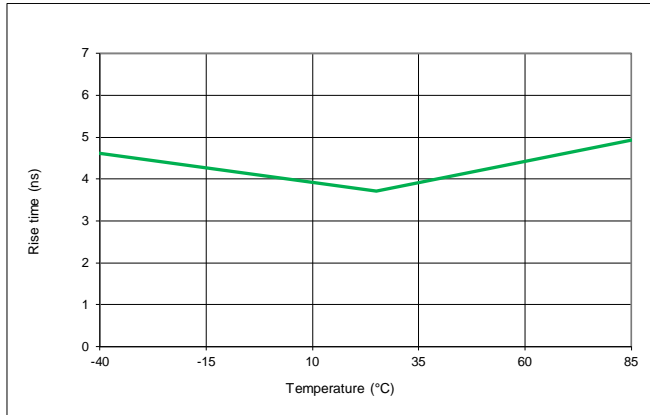

Figure 14. Rise Time vs Temperature^[8]

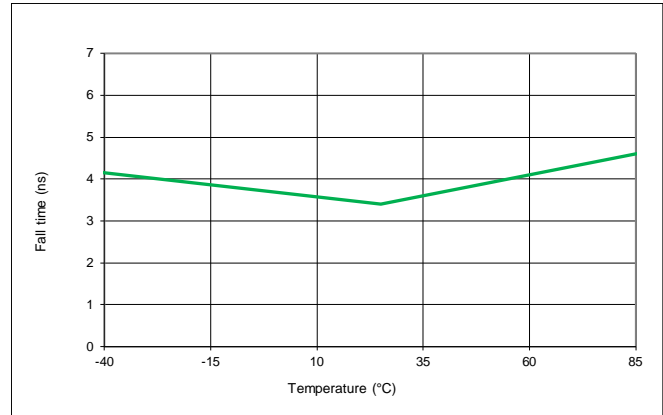

Figure 15. Fall Time vs Temperature^[8]

Notes:

6. All data is measured at room temperature, unless otherwise stated.
7. Data is measured with 15 pF load.
8. Integration range is from 100 Hz to 40 kHz.

SiT8021

Ultra-Small, 1 to 26 MHz Oscillator



Dimensions and Patterns

Package Size – Dimensions (Unit: mm)	Recommended Land Pattern (Unit: mm)
<p>1.55 x 0.85 mm CSP</p> <p>Top View</p> <p>1.54 ± 0.04</p> <p>0.84 ± 0.04</p> <p>#4 #3</p> <p>#1 #2</p> <p>Bottom View</p> <p>0.315 ± 0.015</p> <p>1.00 BSC</p> <p>0.41 BSC</p> <p>Side View</p> <p>0.04</p> <p>Polymer coating</p> <p>0.60 MAX</p>	<p>0.25 (4x) NSMD pads</p> <p>#4 #3</p> <p>#1 #2</p> <p>0.41</p> <p>1.00</p> <p>0.35 (4x) Soldermask openings</p> <p>(soldermask openings shown with heavy dashed line)</p> <p>Recommend 4-mil (0.1mm) stencil thickness</p>

SiT8021

Ultra-Small, 1 to 26 MHz Oscillator



The Smart Timing Choice™

Ordering Information

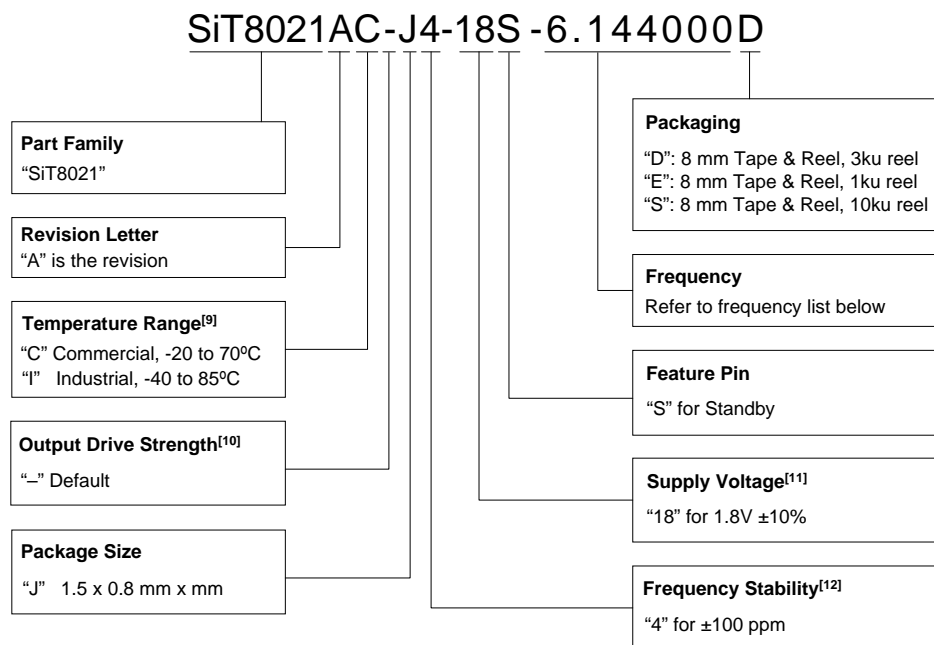

Notes:

9. Contact SiTime for -40 to 105°C option.
10. Contact SiTime for other drive strength options that result in different rise/fall time for any given output load.
11. Contact SiTime for 3.3V option.
12. Contact SiTime for ±25 or ±50 ppm options.

Table 5. List of Standard Frequencies^[13]

2.048 MHz	4 MHz	6.144 MHz	8 MHz	12 MHz	12.288 MHz	16 MHz
19.2 MHz	24 MHz	26 MHz				

Notes:

13. All frequencies from 1 to 26 MHz are in production. Contact your SiTime distributors or SiTime sales offices for minimum order quantity requirement.

SiT8021

Ultra-Small, 1 to 26 MHz Oscillator



The Smart Timing Choice™

Revision History

Table 5. Datasheet Version and Change Log

Version	Release Date	Change Summary
0.1	12/15/14	Advance Information
0.2	1/27/15	<ul style="list-style-type: none"> Updated CSP dimension tolerance Removed 2.0 mm x 1.6 mm package Changed to 6.144 MHz as the reference frequency for jitter, IDD and other relevant parameters Changed resume time (max) to 5 ms Changed the parameter PSNR to Power Supply Noise Sensitivity and specified in RMS
0.3	3/31/15	<ul style="list-style-type: none"> Changed VIL and VIH values in the EC table Reduced standby time in the EC table Revised phase jitter condition to include power supply noise sensitivity Removed power supply noise spec
0.9	5/22/15	<ul style="list-style-type: none"> Added typical values for active and standby current Added current consumption for additional frequencies Changed ± 50 ppm option to Contact SiTime Added manufacturing guideline Other miscellaneous format and footnote changes
1.0	11/18/15	<ul style="list-style-type: none"> Revised initial tolerance, current consumption, standby current, input high/low voltage, input pull-down impedance, startup/resume time and RMS period/phase jitter in Table.1 Added performance plots
1.1	2/19/16	<ul style="list-style-type: none"> Added 10 Standard frequencies to the ordering information
1.11	9/16/16	<ul style="list-style-type: none"> Updated the table.5 list of standard frequencies Added a graph of Idd vs Frequency without load to the performance plots section

© SiTime Corporation 2015. The information contained herein is subject to change at any time without notice. SiTime assumes no responsibility or liability for any loss, damage or defect of a Product which is caused in whole or in part by (i) use of any circuitry other than circuitry embodied in a SiTime product, (ii) misuse or abuse including static discharge, neglect or accident, (iii) unauthorized modification or repairs which have been soldered or altered during assembly and are not capable of being tested by SiTime under its normal test conditions, or (iv) improper installation, storage, handling, warehousing or transportation, or (v) being subjected to unusual physical, thermal, or electrical stress.

Disclaimer: SiTime makes no warranty of any kind, express or implied, with regard to this material, and specifically disclaims any and all express or implied warranties, either in fact or by operation of law, statutory or otherwise, including the implied warranties of merchantability and fitness for use or a particular purpose, and any implied warranty arising from course of dealing or usage of trade, as well as any common-law duties relating to accuracy or lack of negligence, with respect to this material, any SiTime product and any product documentation. Products sold by SiTime are not suitable or intended to be used in a life support application or component, to operate nuclear facilities, or in other mission critical applications where human life may be involved or at stake. All sales are made conditioned upon compliance with the critical uses policy set forth below.

CRITICAL USE EXCLUSION POLICY

BUYER AGREES NOT TO USE SITIME'S PRODUCTS FOR ANY APPLICATION OR IN ANY COMPONENTS USED IN LIFE SUPPORT DEVICES OR TO OPERATE NUCLEAR FACILITIES OR FOR USE IN OTHER MISSION-CRITICAL APPLICATIONS OR COMPONENTS WHERE HUMAN LIFE OR PROPERTY MAY BE AT STAKE.

SiTime owns all rights, title and interest to the intellectual property related to SiTime's products, including any software, firmware, copyright, patent, or trademark. The sale of SiTime products does not convey or imply any license under patent or other rights. SiTime retains the copyright and trademark rights in all documents, catalogs and plans supplied pursuant to or ancillary to the sale of products or services by SiTime. Unless otherwise agreed to in writing by SiTime, any reproduction, modification, translation, compilation, or representation of this material shall be strictly prohibited.