









32.768kHz Series Tuning Fork Crystal Units

The 32.768kHz tuning fork crystal unit is the most widely used frequency control product. TAITIEN's tuning-fork-type crystals have low power consumption ideal for portable application. Their different package sizes provide the customers more choices for time management. TAITIEN's tuning-fork-type crystals are cost effective real time clock products.

Type	XA	XB		XD			XN	
Size (mm)	3 x 8	1 x 4	2 x 6	2.0 x 1.2	3.2 x 1.5	4.1 x 1.5	6.9 x 1.4	8.0 x 3.8
Package	DIP	DIP	DIP	SMD	SMD	SMD	SMD	SMD
RoHS	Yes	Yes	Yes	Yes	Yes	Yes	Yes*	Yes*
Outline								

* Pb in high temperature solder (exempt per RoHS 2002/95/EC Annex (7)) and suitable for RoHS compliant reflow

ELECTRICAL SPECIFICATION

Nominal Frequency	32.768000 kHz
Mode of Vibration	Fundamental
Storage Temp. Range (T _{STR})	-55°C ~+125 °C
Turnover Temperature (TM)	25±5 °C
Temperature Coefficient (β)	-(0.03±0.01) ppm/°C ²
Frequency vs. Temperature (Δf / fM)	β x (T-TM) ² ppm
Series Resistance (R1)	65~90 KΩ Max.
Level of Drive (DL)	0.1±0.01 uW Typ, 0.5 uW Max.
Aging (first year) (Δf / f0)	±3 ppm Max.
Quality Factor (Q)	30000~60000 Typ.
Shunt Capacitance (C0)	3~7 pF Max.
Load Capacitance (CL)	6, 7, 9, 12.5 pF (Please contact us)
Frequency Tolerance(f _{tol})	±20 ppm @ 25±5 °C
Insulation Resistance	500 MΩ Min. @ DC 100±15 V

Specifications subject to change without notice

FREQ. vs. CAPACITANCE RATIO (C0/C1)

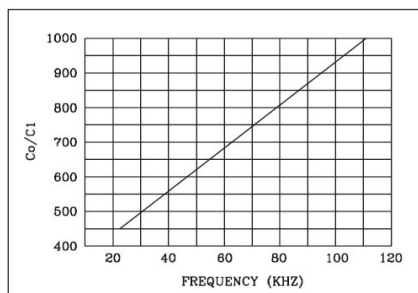

FREQ. vs. LOAD CAPACITANCE (TYP.)

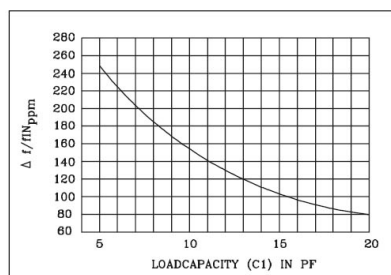

FREQ. vs. TEMPERATURE (TYP.)

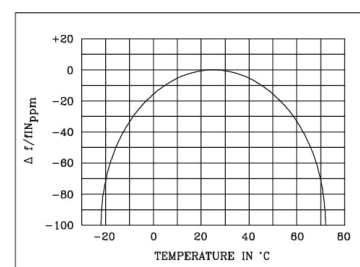

DIMENSION (mm) – XA / XB Type

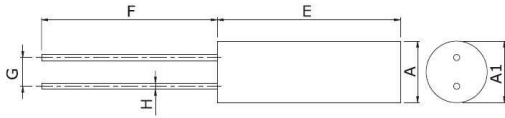

UNIT:mm

TYPE	A	A'	E	F	G	H
XA	3.0	3.1max	8.0max	10±1	0.8±0.2	∅0.32±0.07
XB-N	2.0	2.1max	6.0max	5.0min	0.7±0.2	∅0.28±0.05
XB-J	1.0	1.2max	4.6max	5.7min	0.3±0.05	∅0.18±0.03

DIMENSION (mm) – XD Type

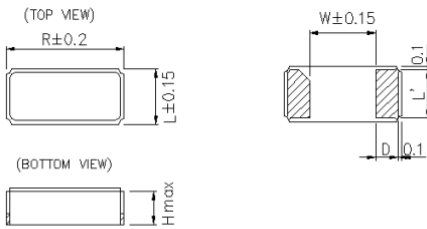

Model	R	L	H	W	L'	D	S	P	∠L'
4115	4.1	1.5	0.9	2.7	1.3	0.6	3.4	1.1	1.8
3215	3.2	1.5	0.9	1.7	1.3	0.6	2.5	1.1	1.8
2012	2.0	1.2	0.6	0.8	1.0	0.5	1.4	0.6	1.1

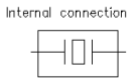

SOLDER PAD LAYOUT (mm)

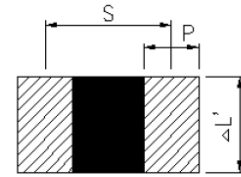

Do not design any patterns on shaded area
Recommended soldering pattern

DIMENSION (mm) – XN Type

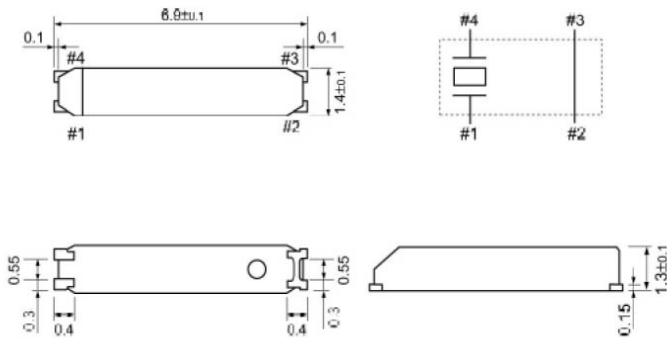

* Do not connect to external with #2 and #3

SOLDER PAD LAYOUT (mm)

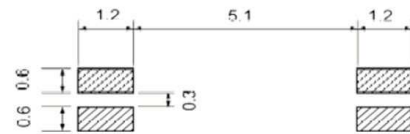

DIMENSION (mm) – XN Type

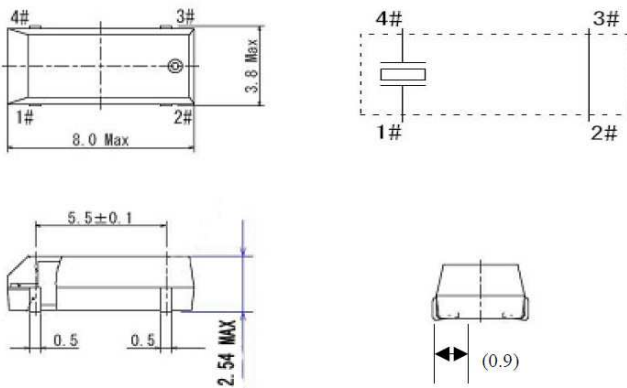

SOLDER PAD LAYOUT (mm)

