

Helping Customers Innovate, Improve & Grow



MX-503

Features

- Ultra High Stability MCXO
- Low Power Consumption
- Meets Stratum 3 acc. GR-1244
- ROHS 6 Compliant
- Frequency Range¹: 8 - 40 MHz
- Standard Frequencies : 10, 12.8, 16.384, 19.2, 20, 22.1184,
• 24.576, 25, 38.4, 40 MHz
- Uses Vectron's Ultra Smooth Compensation (USC) Algorithm
- Excellent Phase Noise and Allan Deviation

Applications

- 1588 Application
- Test Equipment
- Femto Base Station
- Communication Equipment

Performance Specifications

Frequency Stabilities ^{1,3} (Standard - 8 to 26 MHz)						
Parameter	Min	Typical	Max	Units	Condition ²	Options ³
vs. operating temperature range referenced to (dFmax+dFmin)/2	-30		+30	ppb	-40 to +85°C	
	-50		+50	ppb	-40 to +85°C	
	-20		+20	ppb	-20 to +70°C	
	-30		+30	ppb	-20 to +70°C	
In a 24h period at constant temperature	-5		+5	ppb	after 7 days of continuous operation	
Frequency vs. temperature slope		±1.0		ppb/°C	-30 to +80°C, 10 & 20MHz	
		±1.5		ppb/°C	-40 to +85°C, 10 & 20MHz	
Initial tolerance	-0.5		+0.5	ppm	V _s ±5% static Load ±10% static after 30 days of operation after 30 days of operation	
vs. supply voltage change	-10		+10	ppb		
vs. load change	-10		+10	ppb		
vs. aging / 1. year	-0.8		+0.8	ppm		
vs. aging / 10 years	-2.5		+2.5	ppm		

Performance Specifications

Supply Voltage (V _s)					
Parameter	Min	Typical	Max	Units	Condition ²
Supply Voltage (standard)	3.135	3.3	3.465	V	8 - 40MHz
Current Consumption			12	mA	
RF Output					
Signal [standard]	HCMOS				
Load		15		pF	
Signal Level (Vol)			0.3	V	V _s = 3.3V
Signal Level (Voh)	3			V	V _s = 3.3V
Duty Cycle	45		55	%	@ V _s /2
Rise and Fall time			5	ns	10 to 90 %
Frequency Tuning (EFC) 8 to 26 MHz					
Tuning Range	Fixed frequency; No adjust				Option ³
Tuning Range	±3.5		+10	ppm	
Linearity			2	%	10 & 20MHz
Tuning Slope	Positive				
Control Input Impedance	20			kOhm	
Control Voltage (V _c) Range	0.0	1.65	3.3	V	
Additional Parameters					
Phase Noise ⁴		-65		dBc/Hz	1 Hz
		-93		dBc/Hz	10 Hz
		-118		dBc/Hz	100 Hz
		-140		dBc/Hz	1 kHz
		-154		dBc/Hz	10 kHz
		-156		dBc/Hz	100 kHz
Jitter		140		fs RMS	@ 12 kHz to 20 MHz
ADEV			80	E-12	@ 1sec.
			80	E-12	@10sec
Weight			2.0	g	
Processing & Packing	Handling & Processing Note				
Reflow Profile	IPC / JEDEC J-STD-020 (latest version)				
Absolute Maximum Ratings					
Supply Voltage (V _s)	-0.6		6.0	V	
Output Load			50	pF	
Operable Temperature Range	-40		+85	°C	
Storage Temperature Range	-40		+90	°C	
Environmental Conditions					
Rapid Temperature Changes	MIL-883-1010 Cond B 500 cycles -55/125C				
Vibration	MIL-STD-883 Meth 2007 Cond A 20G 20-2000Hz 4x in each 3axis 4 min				
Shock	MIL-STD-202 Meth 213B Cond. F; 1500g 0,5ms 6 shocks in each direction				
Solderability	J_STD_002C Cond A, Through hole device/ Cond. B, SMD 255C (diving time 50,5sec.) Dip+Look with 8h damp pre-treatment: solder wetting >95%				
Solvent Resistance	MIL-STD-883 Meth 2015 Solv. 1,3,4				
ESD	JESD22-A114F Class 1B; 10* 2000V				
Moisture Sensitivity	Level 1 JESD22-A113-B				
RoHS Compliance	100% ROHS Compliant				

Outline Drawing / Enclosure

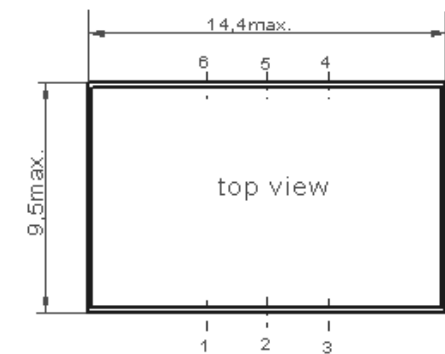

G 287

MX-503	
Height "H"	Pin Length "L"
3.8	NA

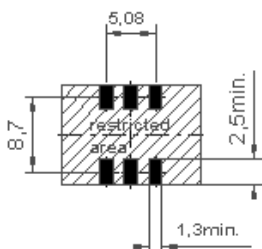
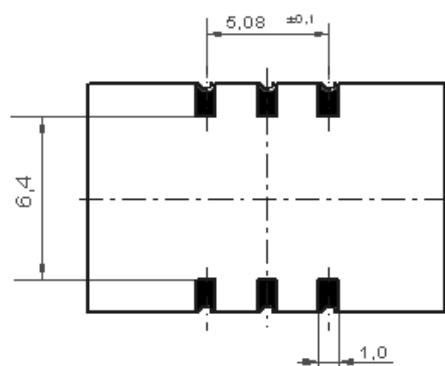
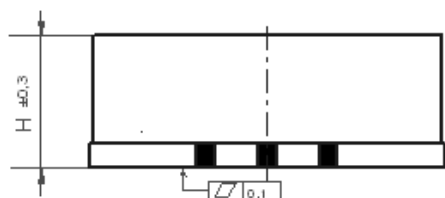

Padvorschlag
land pattern
recommendation

Pin Connections	
1	Control Voltage Input (Vc) / N.C.
2	N.C.
3	Ground (Case)
4	RF-Output
5	N.C.
6	Supply Voltage Input (Vs)

Dimensions in mm

Performance Data

TDEV-without filter

ADEV

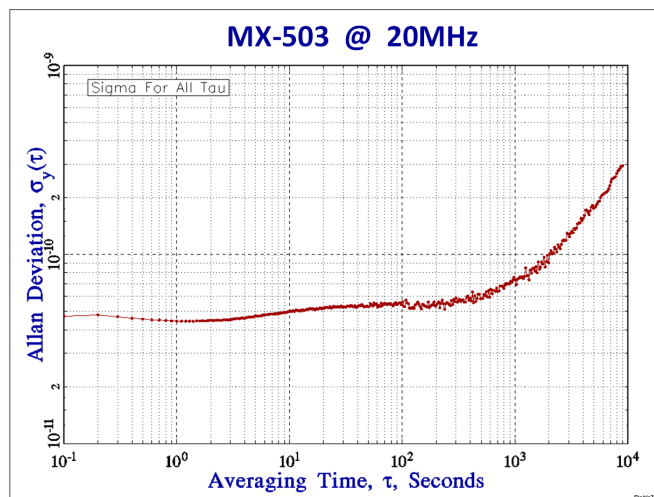
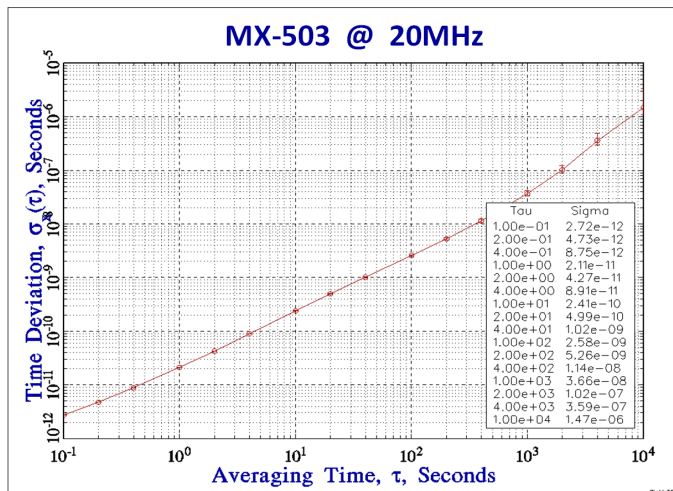

Temperature Stability

Phase Noise⁴

Frequency vs. Temperature
MX-503 @ 20MHz

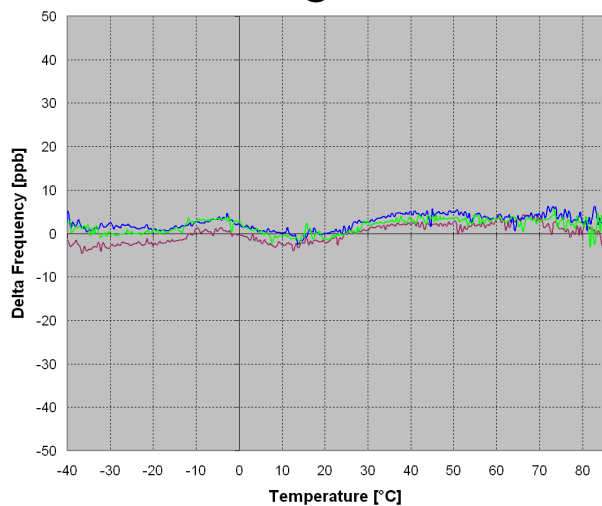

MX-503 @ 20MHz
Typical Phase Noise

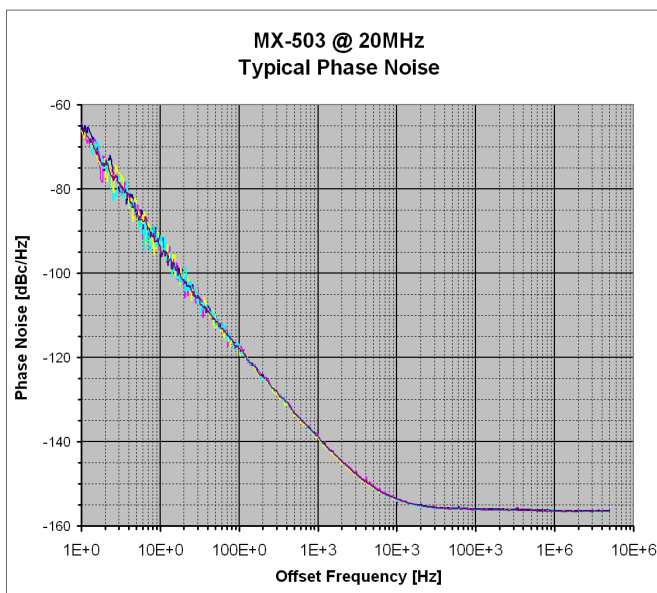

Performance Data

Frequency vs. Load

Frequency vs. Supply Voltage

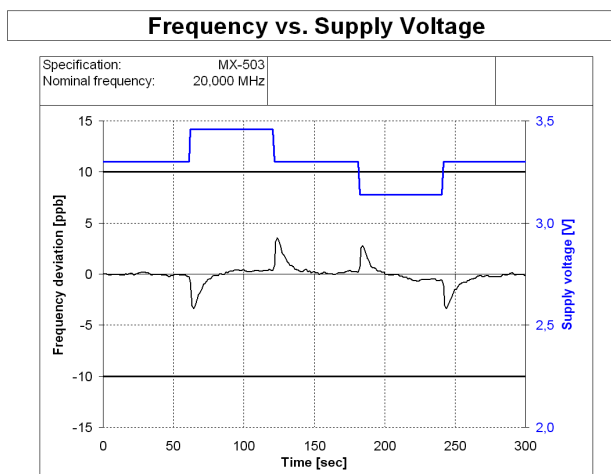
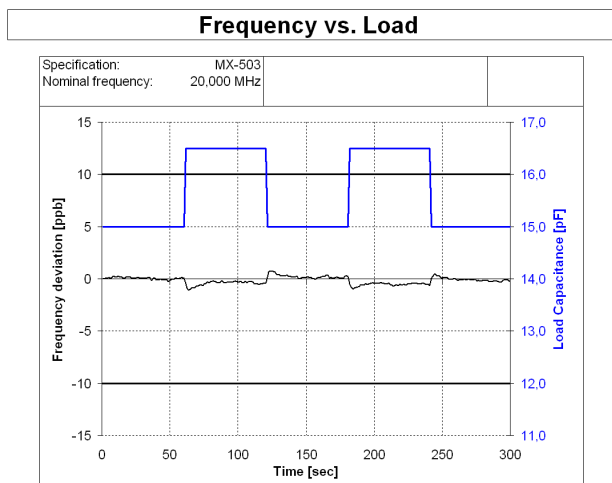

Aging

Aging: MX-503 @ 20MHz

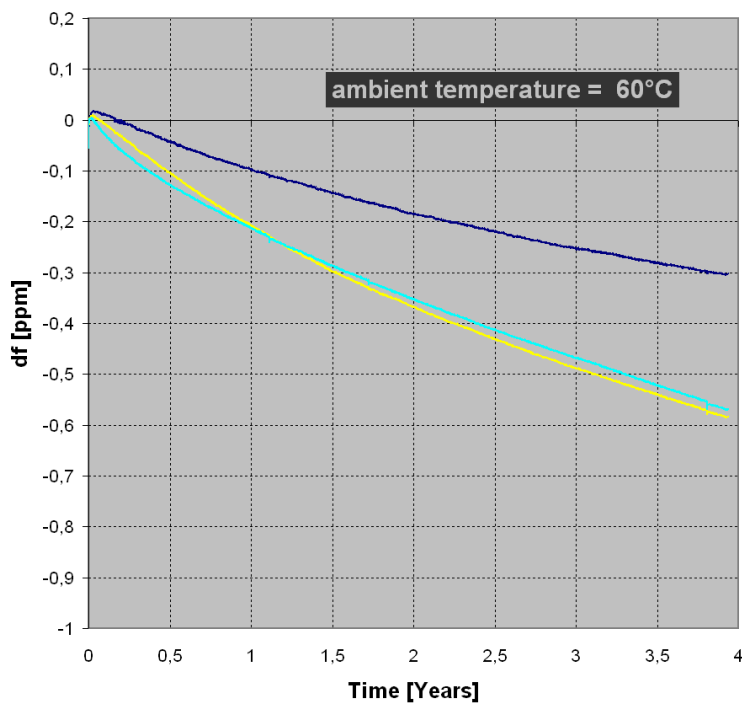

Recommended Reflow Profile

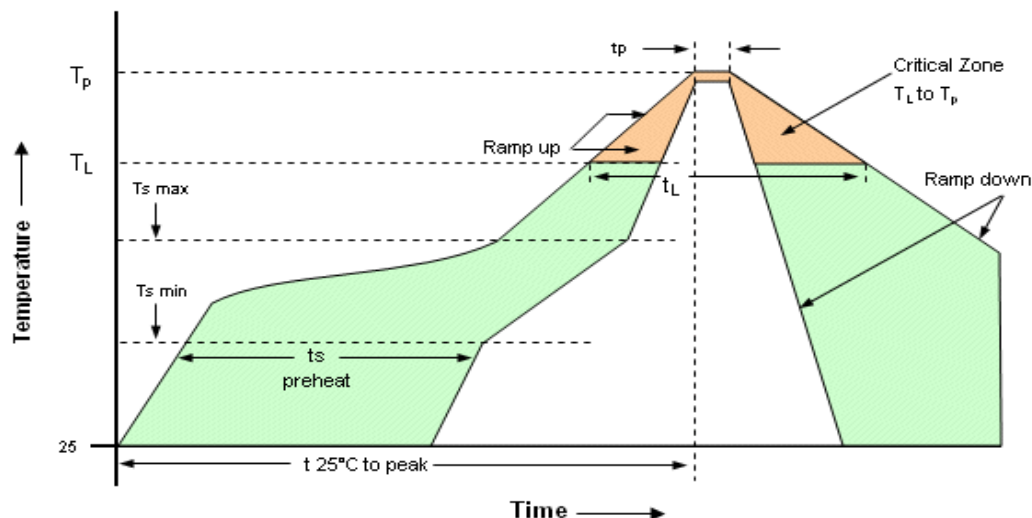

Profile Feature	Pb-Free Assembly/ Sn-Pb Assembly	Profile Feature	Pb-Free Assembly/ Sn-Pb Assembly
Average ramp-up rate (T_L to T_p)	3°C/second max.	Time 25°C to Peak Temperature	8 minutes max.
Preheat -Temperature Min T_{smin} -Temperature Max T_{smax} -Time (min to max) t_s	150°C 200°C 60-180 seconds	Time maintained above -Temperature (T_L) -Time (t_L)	217°C 60-150 seconds
T_{smax} to T_L -Ramp-up Rate	3°C/second max		
Time maintained above -Temperature (T_L) -Time (t_L)	217°C 60-150 seconds	Time within 5°C of actual Peak Temperature (t_p)	20-40 seconds
Peak Temperature (T_p)	max 260°C	Ramp-down Rate	6°C/ second max

Note: All temperatures refer to topside of the package, measured on the package body surface.
SMD oscillators must be on the top side of the PCB during the reflow process.

Standard Shipping Method (MX-503)

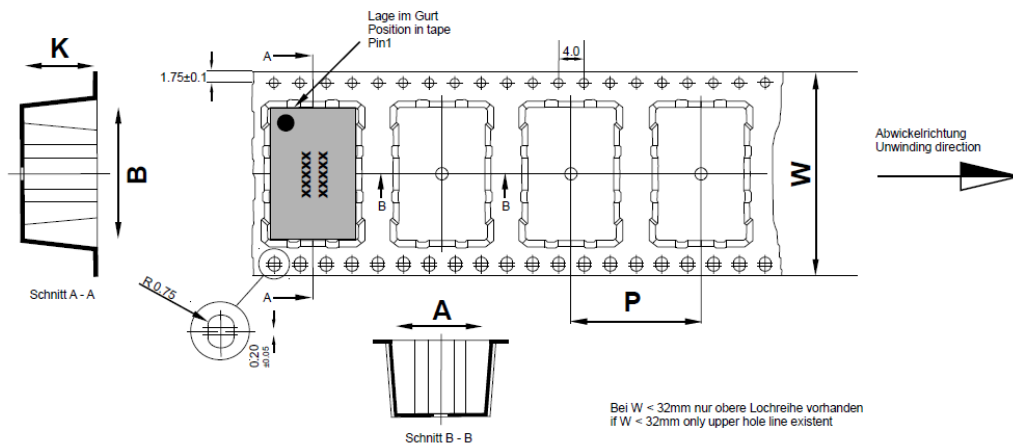

Maßangaben in mm: A, B und K Maße von Bauelement abhängig Fertigungstoleranzen entsprechen der DIN IEC 286-3	Dimension in mm: A, B und K are dependent upon component dimensions production tolerance complying DIN IEC 286-3
--	--

All dimensions in millimeters unless otherwise stated

Enclosure Type	Tape Width W (mm)	Quantity per meter	Quantity per reel	Dimension P
G287	24	83,3	850	12

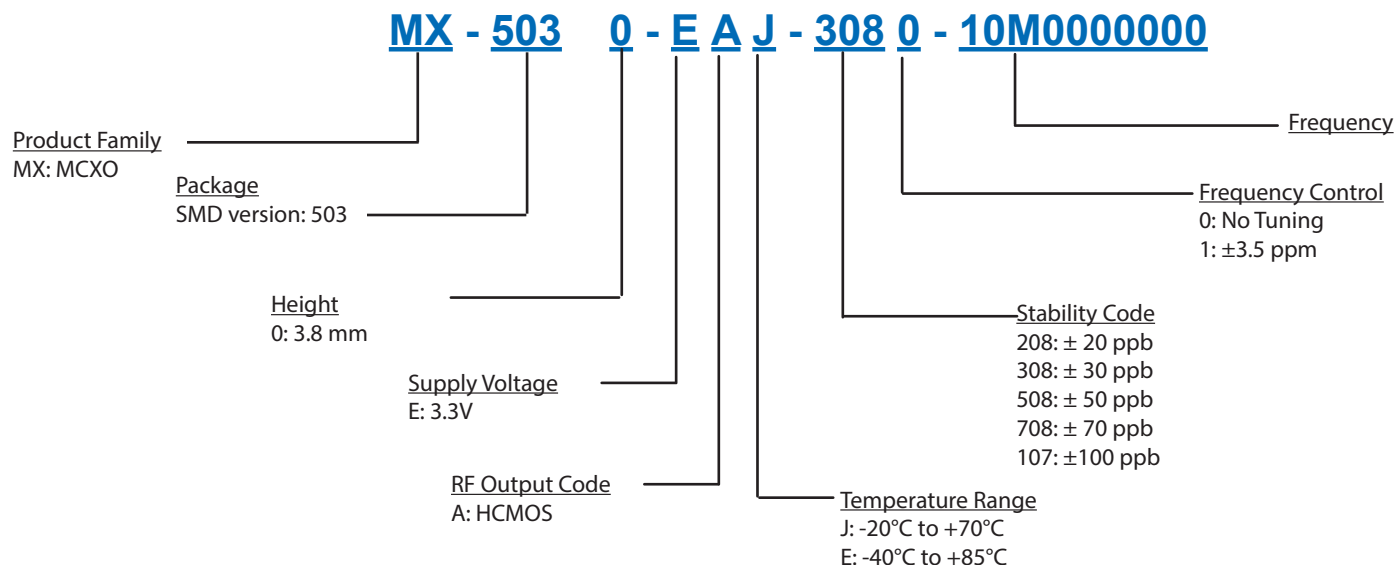
Ordering Information^{1,3}**Notes:**

1. Contact factory for other frequencies. Not all options and codes are available at all frequencies.
2. Unless otherwise stated conditions are valid at F=20MHz; $V_s=3.3V$; $V_c=1.65$; T=25°C; Output Signal=HCMOS; load=15pF
3. Contact factory for availability.
4. Phase noise degrades with increasing output frequency.

Subject to technical modification.

For Additional Information, Please Contact

USA:

Vectron International
267 Lowell Road, Suite 102
Hudson, NH 03051
Tel: 1.888.328.7661
Fax: 1.888.329.8328

Europe:

Vectron International
Landstrasse, D-74924
Neckarbischofsheim, Germany
Tel: +49 (0) 7268.801.100
Fax: +49 (0) 7268.801.282

Asia:

Vectron International
68 Yin Cheng Road(C), 22nd Floor
One LuJiaZui
Pudong, Shanghai 200120, China
Tel: +86 21 6194 6886
Fax: +86 21 6194 6699

Disclaimer

Vectron International reserves the right to make changes to the product(s) and or information contained herein without notice. No liability is assumed as a result of their use or application. No rights under any patent accompany the sale of any such product(s) or information.