

OX-204 at 10 MHz

Ultra Low Phase Noise
Oven Controlled Crystal Oscillator

Helping Customers Innovate, Improve & Grow



The OX-204 is an Ultra Low Phase Noise Ovenized Crystal Oscillator with a noise floor as low as -175 dBc/Hz. Designed for applications that demand extremely low noise sources, including the reference oscillator for a phase-locked loop in the microwave spectrum. Custom frequencies available upon request.

Features

- -140 dBc/ Hz at 10 Hz offset
- -175 dBc/Hz at 10 kHz offset
- 10 MHz standard, other frequencies available

Applications

- Military Radar
- Instrumentation and Test Equipment
- Synthesizers
- Military Communication Equipment
- DRO reference
- Satellite Communications

Performance Specifications

Phase Noise Ordering Codes at 10 MHz						
Frequency Offset (Hz)	A	B	C	D (12V only)	Unit	Condition
1	-95	-100	-105	-110	dBc/Hz	Maximum values All EFC settings
10	-125	-130	-135	-140		
100	-150	-155	-157	-157		
1000	-160	-165	-167	-165		
10,000	-170	-170	-175	-170		
100,000	-170	-170	-175	-170		

Frequency Stabilities at 10 MHz					
Parameter	Min	Typical	Max	Unit	Condition
vs. operating temperature range	-10		+10	ppb	-20 to +70°C (referenced to +25°C)
	-20		+20	ppb	-40 to +85°C (referenced to +25°C)
vs. Initial Tolerance	-100		+100	ppb	at time of shipment and 5V efc
Allan Deviation			5	E-12	0.1 to 1 second tau
vs. supply voltage change	-2		+2	ppb	±5% change
vs. load change	-2		+2	ppb	5% change in load
vs. aging / 1 day	-0.5		+0.5	ppb	after 7 days of operation
vs. aging / 1 st year	-100		+100	ppb	after 7 days of operation
vs. aging / year	-30		+30	ppb	after first year of operation
Warm up time			5	minutes	to ±10 ppb of 2-hour frequency @+25°C

Product Performance Data

Phase Noise

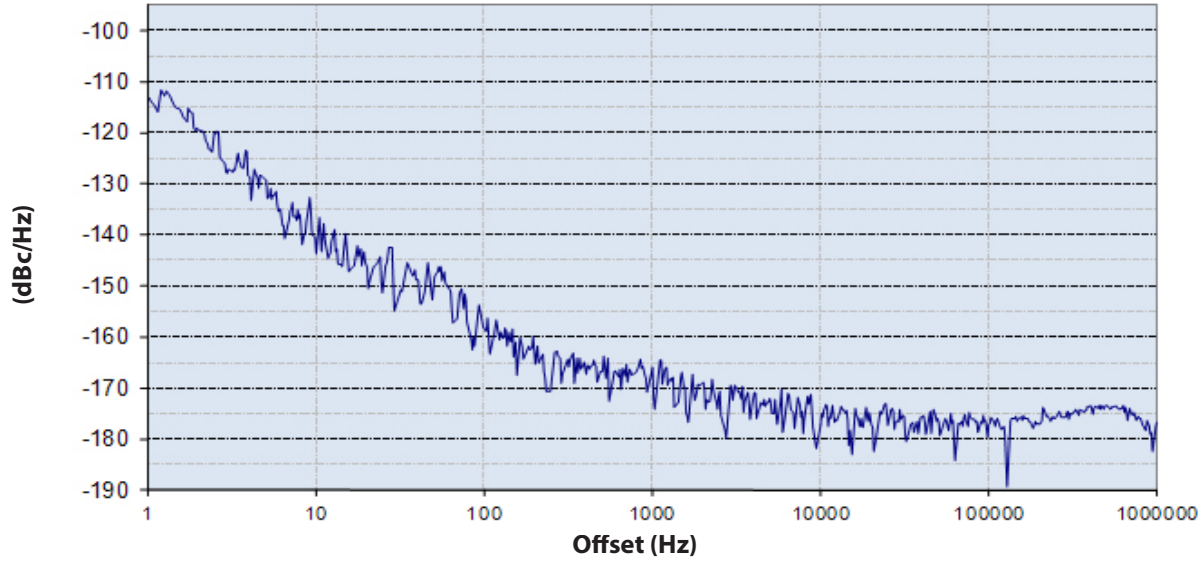

Aging

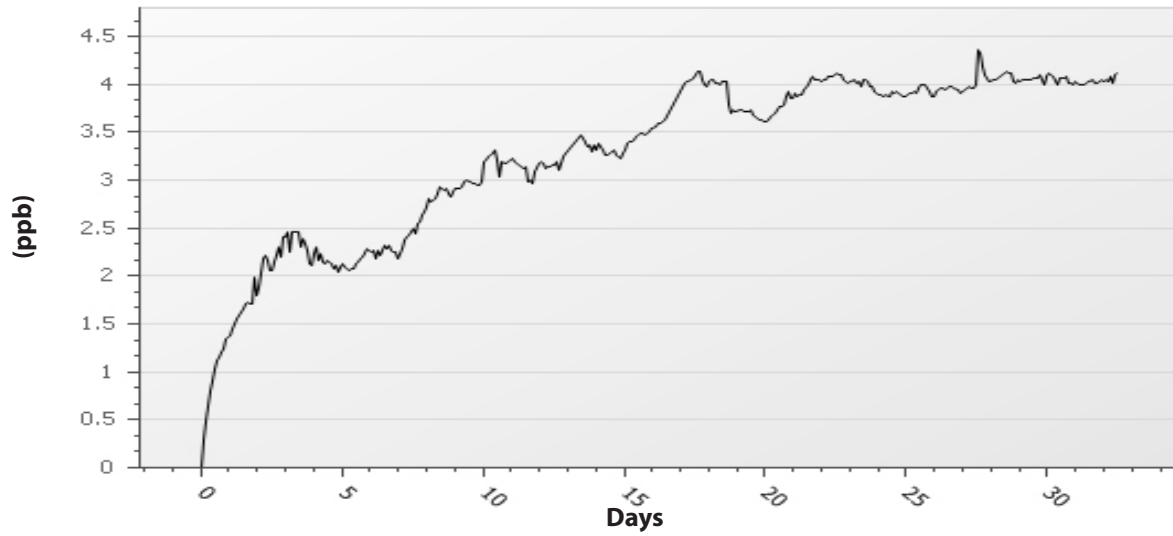

Frequency vs. Temperature

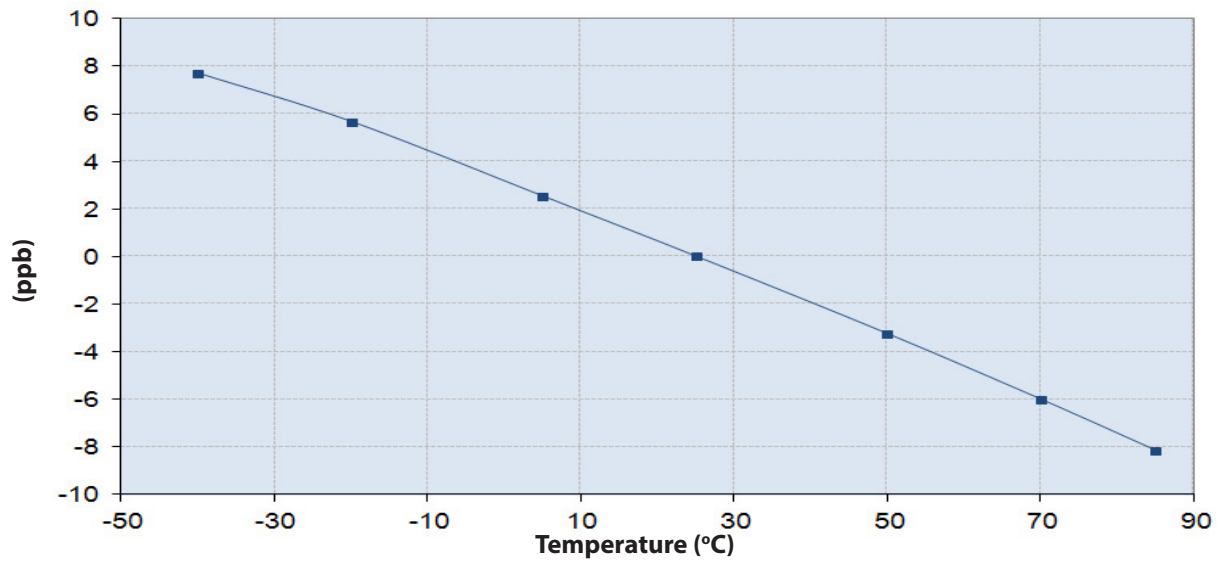

Performance Specifications

Supply Voltage (Vs)					
Parameter	Min	Typical	Max	Unit	Condition
Supply Voltage	11.4	12.0	12.6	VDC	
	4.75	5	5.25	VDC	
Power Consumption			4.0 1.8	Watts Watts	during warm-up steady state @ +25°C
Reference Voltage		10		VDC	12 V version
		4.35		VDC	5 V version
RF Output					
Signal	Sinewave				
Load		50		Ohms	
Output Power	+7.0		+13.0	dBm	50 Ohm load @ Vs=12V
	+4.0		+7.0	dBm	50 Ohm load @ Vs=5V
Harmonics			-30	dBc	50 Ohm load
Spurious			-80	dBc	50 Ohm load
Frequency Tuning (EFC)					
Tuning Range	±400		±800	ppb	enough for aging over 15 year lifetime
Linearity			15	%	
Tuning Slope	Positive				
Control Voltage Range	0		10	VDC	Vs=12V
	0		4.35		Vs=5V
Input Impedance		100		kOhm	
Modulation Bandwidth	150			Hz	
Additional Parameters					
g-sensitivity			1.5	ppb/g	
Weight			20	grams	
Absolute Maximum Ratings					
Parameter	Min	Typical	Max	Unit	Condition
Supply Voltage (Vs)			15	V	12V version
			7	V	5V version
Output Load			25	Ohms	
Operable Temperature Range	-55		+95	°C	Device will not sustain damage when operated at temperatures between the operating range and the operable range, but will not be specification compliant
Environmental and Product Classification					
Shock (Endurance)	MIL-STD-202, Method 213, Condition J, 30g 11 ms				
Sine Vibration (Endurance)	MIL-STD-202, Method 201 and 204, Condition A, except 5g to 500 Hz, 1 sweep each axis				
Random Vibration (Endurance)	MIL-STD-202, Method 214, Condition I-D				
Humidity	MIL-STD-202, Method 103, Condition B, 100% rh				
Seal	MIL-STD-202, Method 112, Condition D				
Altitude	MIL-STD-202, Method 105, sea level to space				
Resistance to Soldering Heat	MIL-STD-202, Method 210, Condition A,B,C				
Terminal Strength	MIL-STD-202, Method 11, Condition C (5 bends at 45°, 2 lbs)				
Moisture Sensitive Level	1				
RoHS	6 (fully compliant) - no pure tin options available upon request, the device will be assigned a customer part number, not orderable through ordering codes				
Storage Temperature Range	-55		+125	°C	

Outline Drawing

Dimensions in mm

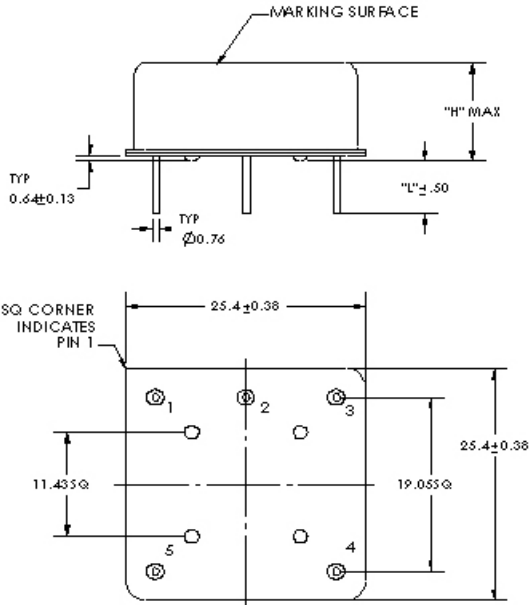

Code	Height "H"	Pin Length "L" Min
0	15.0	6.2
Pin Connections		
1	RF Output	
2	Ground (Case)	
3	Electronic Frequency Control Input (EFC)/ No Connect	
4	Reference Voltage	
5	Supply Voltage Input (VS)	

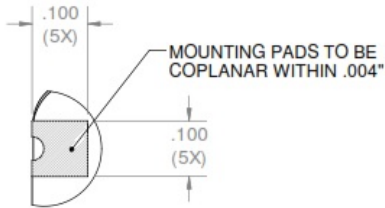

Dimensions in inches

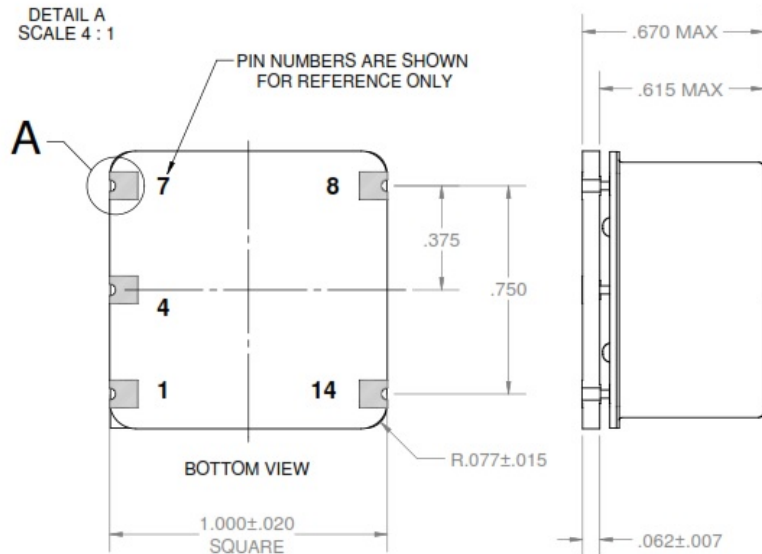

Code	Height "H"	Pin Length "L" Min
1	17.0 mm	na
Pin Connections		
1	RF Output	
4	Ground (Case)	
7	Electronic Frequency Control Input (EFC) No Connect for Fixed frequency Oscillators	
8	Reference Voltage	
14	Supply Voltage Input (VS)	

Ordering Information

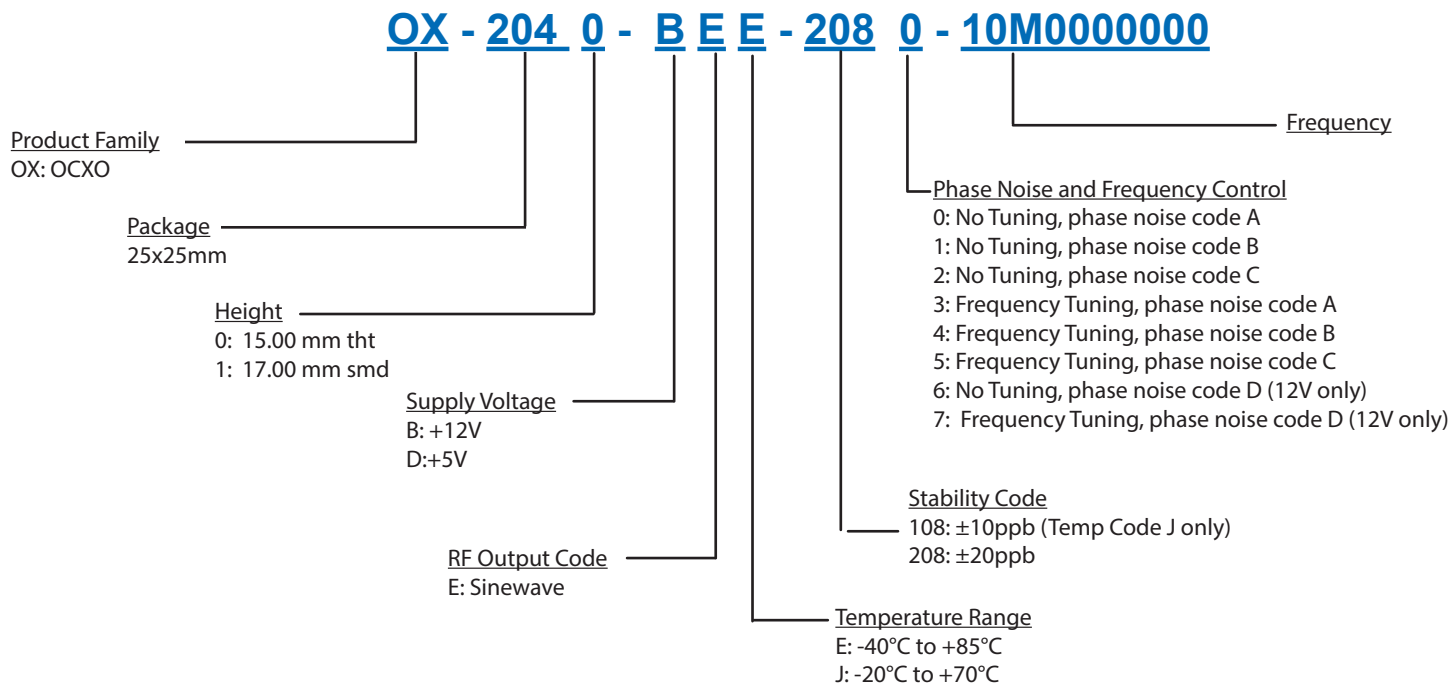

Notes:

1. Contact factory for improved stabilities or additional product options including no pure tin options.
2. Certain codes available for sampling and short lead time requests. Please review website for codes.
3. Unless otherwise stated, all values are valid after warm-up time and refer to typical conditions for supply voltage, frequency control voltage, load, and temperature (25°C).
4. Contact factory for other frequencies. Phase noise degrades for frequencies greater than 10 MHz.
5. Subject to technical modification.
6. Contact factory for availability.

For Additional Information, Please Contact

USA:

Vectron International
267 Lowell Road, Unit 102
Hudson, NH 03051
Tel: 1.888.328.7661
Fax: 1.888.329.8328

Europe:

Vectron International
Landstrasse, D-74924
Neckarbischofsheim, Germany
Tel: +49 (0) 3328.4784.17
Fax: +49 (0) 3328.4784.30

Asia:

Vectron International
68 Yin Cheng Road(C), 22nd Floor
One LuJiaZui
Pudong, Shanghai 200120, China
Tel: +86 21 6194 6886
Fax: +86 21 6194 6699

Disclaimer

Vectron International reserves the right to make changes to the product(s) and or information contained herein without notice. No liability is assumed as a result of their use or application. No rights under any patent accompany the sale of any such product(s) or information.

Rev:11/21/2016 jar