

Helping Customers Innovate, Improve & Grow



PX-990

Features

- Ultra low Phase Noise
- Ultra low G-Sensitivity
- Vibration hardened
- Tight Tolerances
- Frequency Range 60 - 120MHz
- Standard Frequency 120MHz

Applications

- Vibration Environment
- Airborne and Military Equipment
- Portable Equipment
- Radar

Performance Specifications

Parameter	Frequency Stabilities ¹				Units	Condition	Options ³
	Min	Typical	Max				
vs. operating temperature range (referenced to nominal frequency)	-15.0		+15.0		ppm	-20 to +70°C	
	-25.0		+25.0		ppm	-40 to +85°C	
Initial tolerance	-15.0		+15.0		ppm	25°C	
vs. supply voltage change	-0.1		+0.1		ppm	V _s ±5% static	
vs. load change	-0.1		+0.1		ppm	Load ±10% static	
vs. aging / 1 year	-1.0		+1.0		ppm	after 30 days of operation	
vs. aging / 10 years	-3.0		+3.0		ppm	after 30 days of operation	

Performance Specifications

Supply Voltage (Vs)						
Parameter	Min	Typical	Max	Units	Condition	
Supply voltage (standard)	14.25	15	15.75	VDC		
Current consumption			100	mA		
RF Output						
Signal [standard]	Sinewave				50 Ω load	
Load	45	50	55	Ohm		
Output Power	10	13	16	dBm	50 Ω load	
Harmonics			-30	dBc	50 Ω load	
Spurious			-80	dBc	50 Ω load	
Additional Parameters						
Phase Noise ²		-90		dBc/Hz	10 Hz	@ 120 MHz 13 dBm sinewave no vibration
		-125		dBc/Hz	100 Hz	
		-153		dBc/Hz	1 kHz	
		-167		dBc/Hz	10 kHz	
		-173		dBc/Hz	100 kHz	
		-175		dBc/Hz	1 MHz	
G-Sensitivity		0.5		ppb/g	without shock absorbers ³	
Weight		55	75	g		
Processing & Packing	Handling & Processing Note					
Additional Environmental Conditions						
Random Vibration	MIL-STD-202G; Method 214A; Cond H					
Shock	MIL-STD-202G; Method 213B; 15 g / 20 ms (for softest shock absorber i.e. lowest resonance frequency)					
Solderability	JEDEC J-STD-002: non RoHS compliant					
Solvent Resistance	non-washable device					
Absolute Maximum Ratings						
Supply voltage (Vs)			16.0	V		
Output Load	45		55	Ω		
Operable Temperature Range	-40		+85	°C		
Storage Temperature Range	-40		+105	°C		

Outline Drawing / Enclosure

Parameter	Min	Typical	Max	Units	Condition
G295 including vibration isolators. Mechanical resonance frequency	35		110	Hz	Please specify vibration profile and phase noise max values under vibration

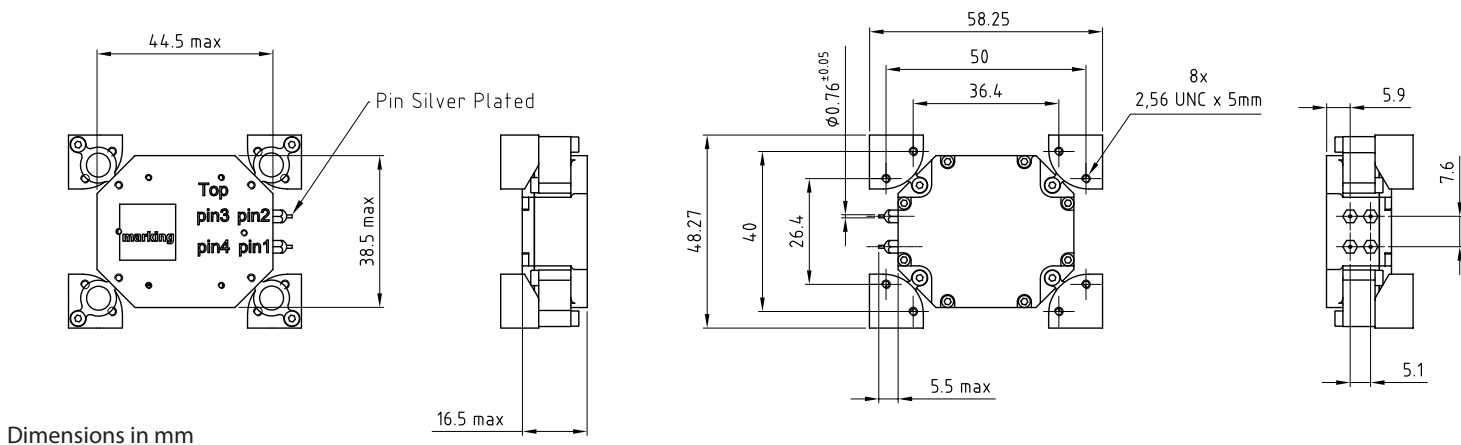
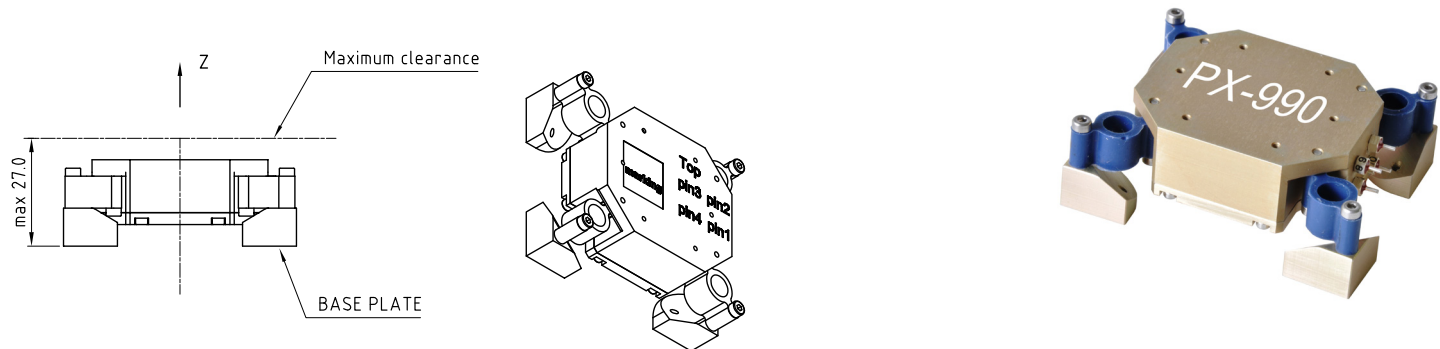

Dimensions in mm

Pin Connections	
1	N.C.
2	Supply Voltage (Vs)
3	RF-Output
4	Ground (Case)

Housing Options

Parameter	Note
G295 Standard with vibration isolators	Option please specify vibration profile and phase noise max values under vibration
G313 without vibration isolators	Option please specify vibration profile and phase noise max values under vibration

Note: Customized housings are possible. Please specify housing and vibration profile and phase noise max values under vibration

Typical Phase Noise @ 120 MHz without vibration

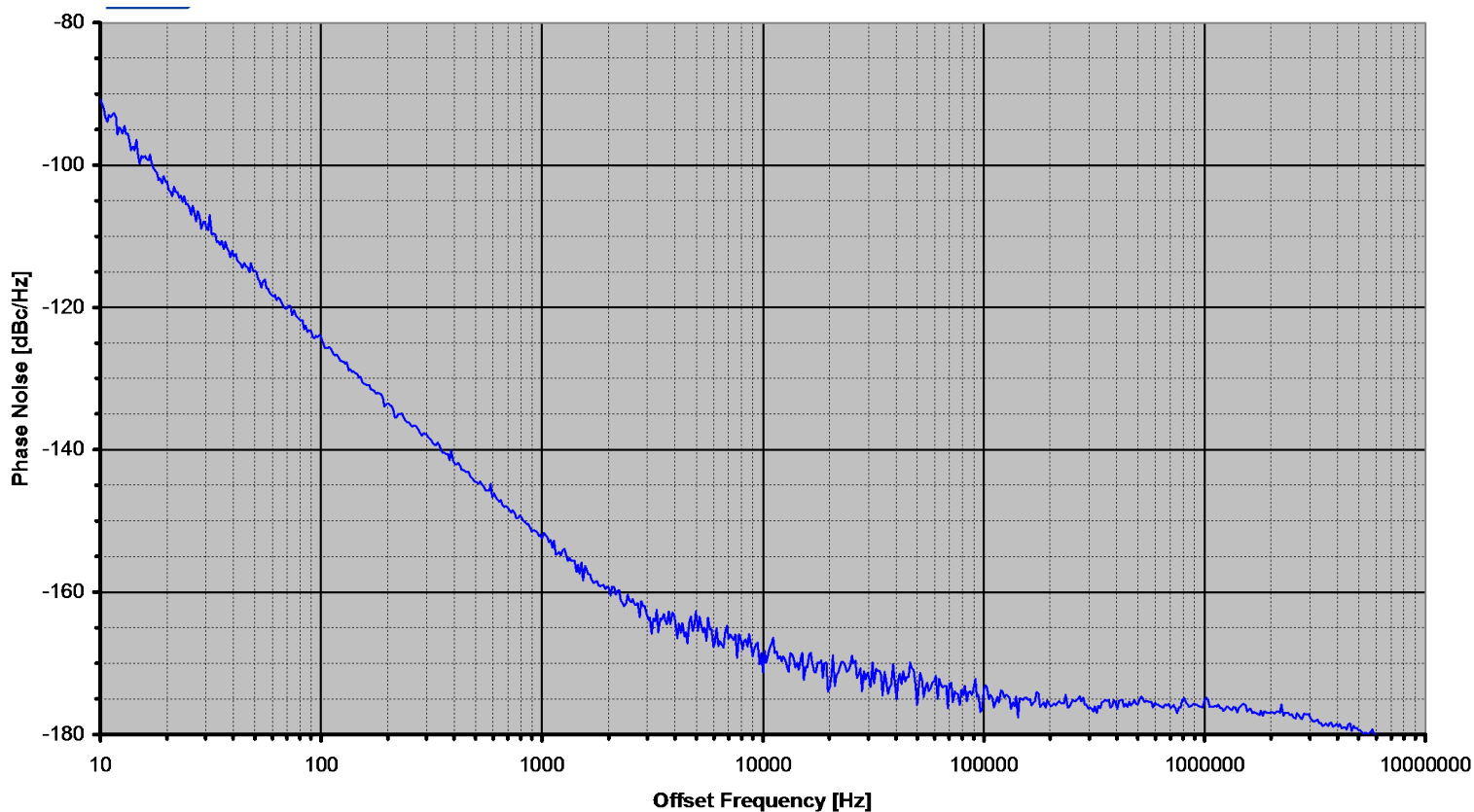

Typical Frequency Stability vs Temperature

Frequency and Pout vs. Temperature

Specification:	PX-990-0001	29.11.2010
Frequency:	120,000 MHz	
Osc.-No.:	SN1	

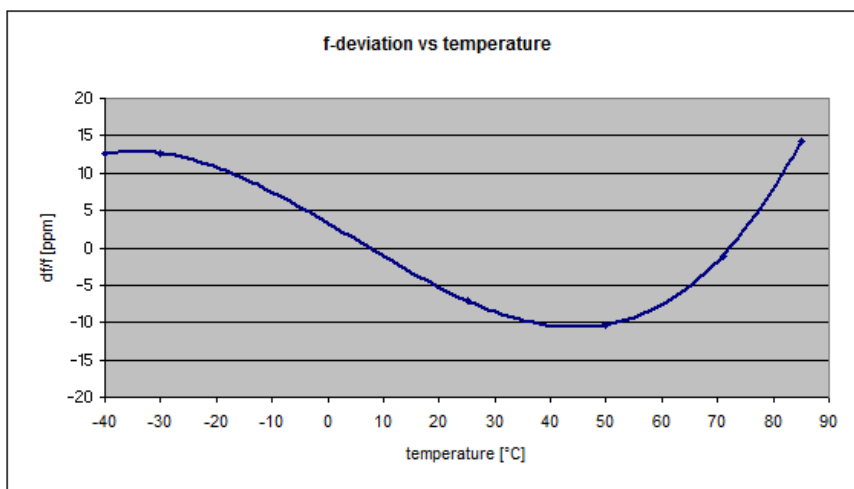

Typical G-Sensitivity @120 MHz without shock absorber

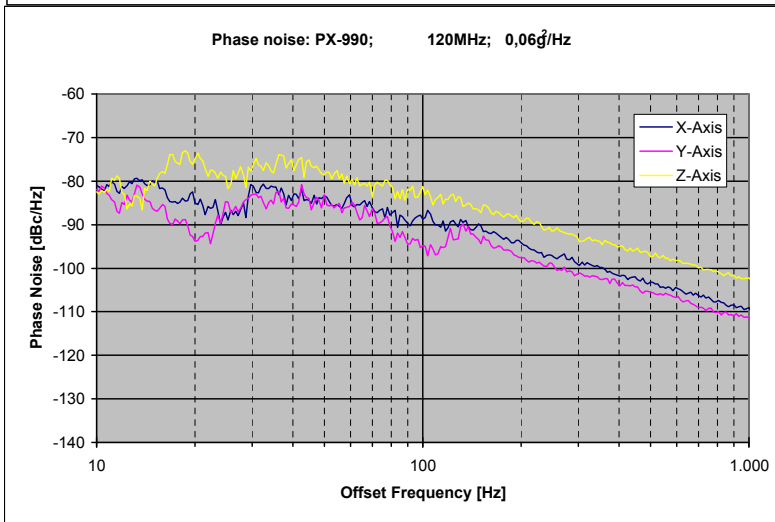
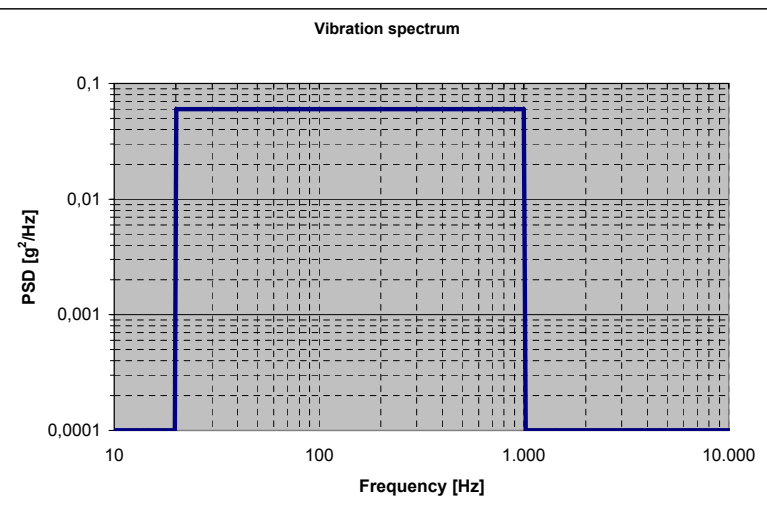
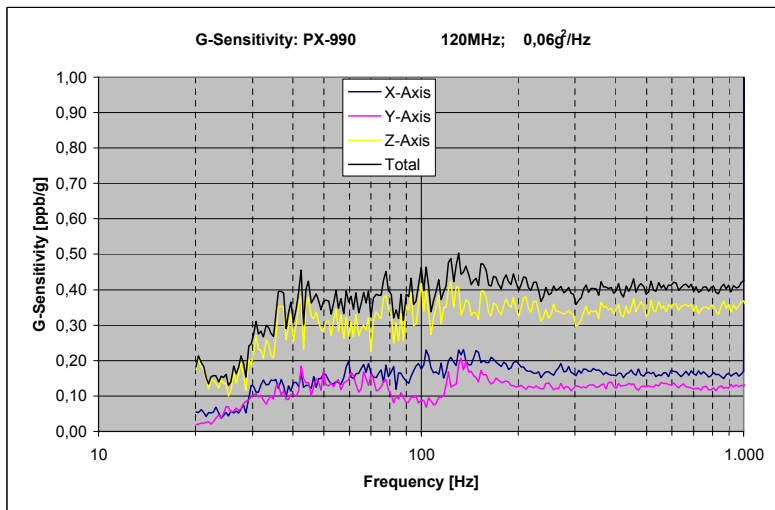

Calculation equation according to Vig-Tutorial

g-sensitivity:
$$G = \frac{2 \cdot f_v}{A_{peak} \cdot f_0} \cdot 10^{\frac{L(f)}{20}}$$

Peak g-level:
$$A_{peak} = \sqrt{PSD \cdot 2}$$

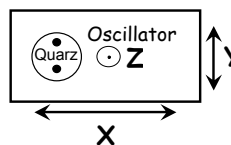

Notes:

1. Contact factory for improved stabilities or additional product options. Not all options and codes are available at all frequencies.
2. Phase noise degrades with increasing output frequency.
3. Contact factory for availability.

Unless other stated all values are valid after warm-up time and refer to typical conditions for supply voltage, frequency control voltage, load, temperature (25°C).

Subject to technical modification.

Typical Phase Noise @ 120 MHz with vibration

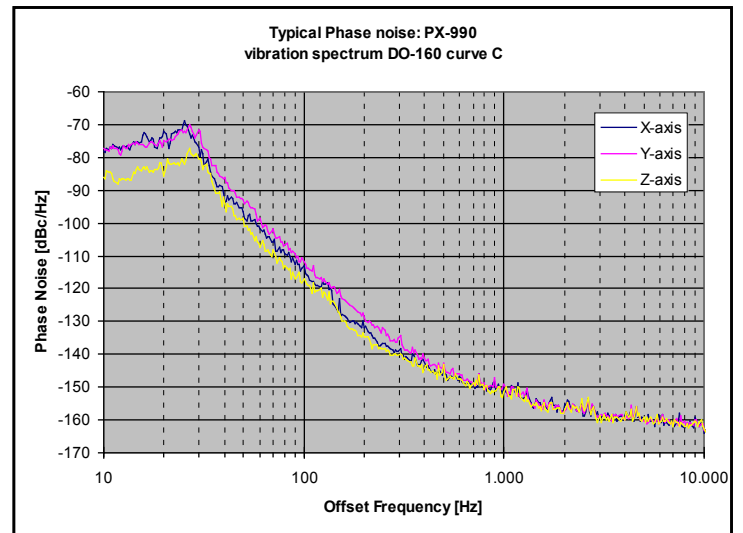
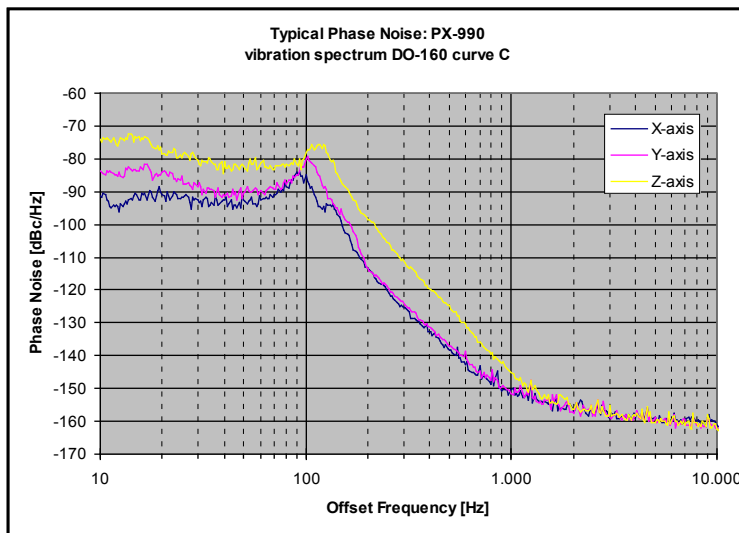
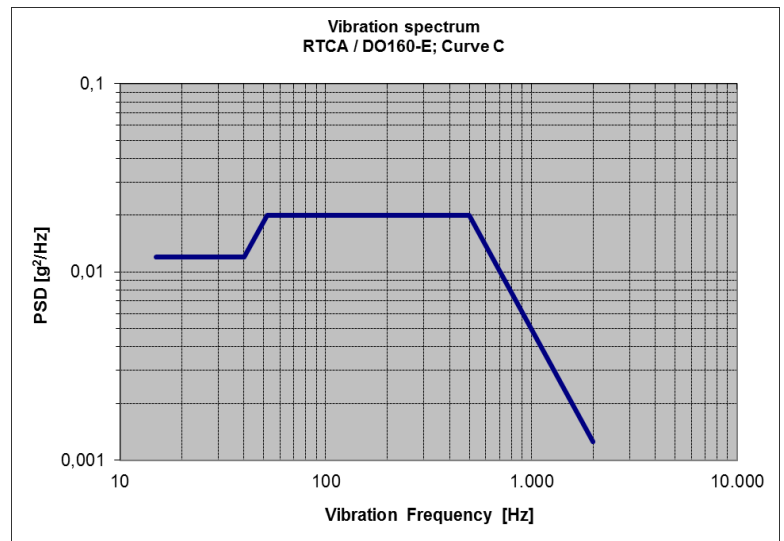
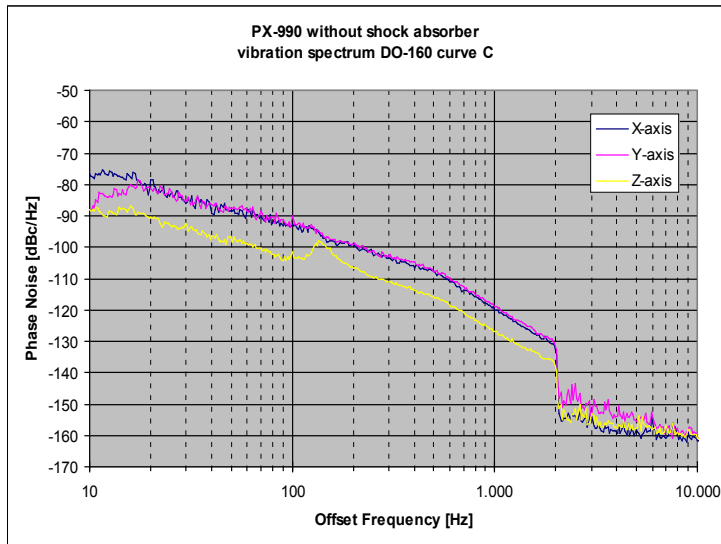

Ordering Information

All Oscillators from the 990s Product Group are Customized. Please include your complete specification, including vibration profile and required phase noise and phase noise under vibration to your inquiry.

For Additional Information, Please Contact

USA:

Vectron International
267 Lowell Road, Suite 102
Hudson, NH 03051
Tel: 1.888.328.7661
Fax: 1.888.329.8328

Europe:

Vectron International
Landstrasse, D-74924
Neckarbischofsheim, Germany
Tel: +49 (0) 7268.801.100
Fax: +49 (0) 7268.801.282

Asia:

Vectron International
68 Yin Cheng Road(C), 22nd Floor
One LuJiaZui
Pudong, Shanghai 200120, China
Tel: +86 21 6194 6886
Fax: +86 21 6194 6699

Disclaimer

Vectron International reserves the right to make changes to the product(s) and or information contained herein without notice. No liability is assumed as a result of their use or application. No rights under any patent accompany the sale of any such product(s) or information.